

# MOTORIZED Exposed Roll

## Installation Guide

### ◆ TOOLS REQUIRED



Screw driver



Drill

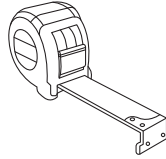

Tape measure



Pencil



Screws

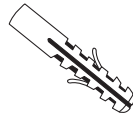

Wall Plug

### ◆ HARDWARE & PARTS INCLUDED



Exposed Roll Brackets

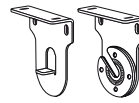

Exposed Roll Brackets

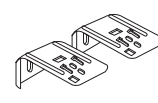

Standard Cassette Brackets

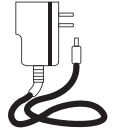

Battery Charger

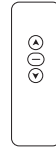

Remote Control  
(1,6 and 16-Channel)

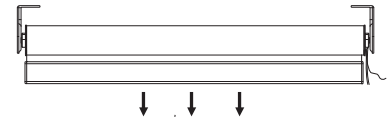
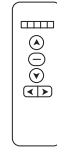

Roller Blinds

### ◆ EXPOSED ROLL OUTSIDE MOUNT

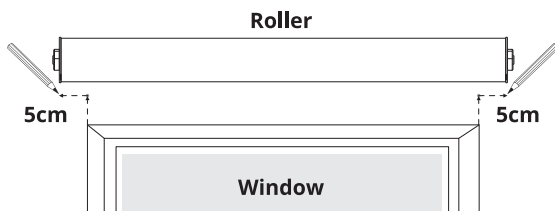

At the top-left and top-right corners of the window, measure the height you wish to place your brackets (at least 5cm required) and make a mark with your pencil.

Determine the difference in width between your shade and your window, and then divide it in half. From your previous marks, measure this distance away from the window, and make another mark with your pencil.

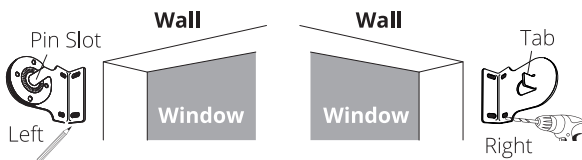

Center the motor bracket at the outermost mark as shown, and use your pencil to mark the screw holes. Repeat this step with your pin bracket at the outer-left mark.

Pre-drill the screw holes with a 0.2cm drill bit at your marks on both sides of the window. Before you attach the brackets, you may want to erase any pencil marks that remain on the mounting surface.

Line up your motor bracket with the screw holes, and insert two screws to secure the bracket to the mounting surface. Repeat this step for your pin bracket. When both brackets are secure, you're ready to mount the shade into the window.

### ◆ EXPOSED ROLL INSIDE MOUNT

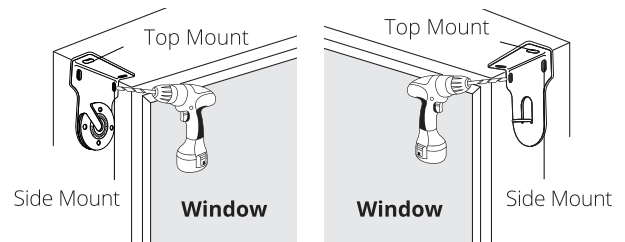
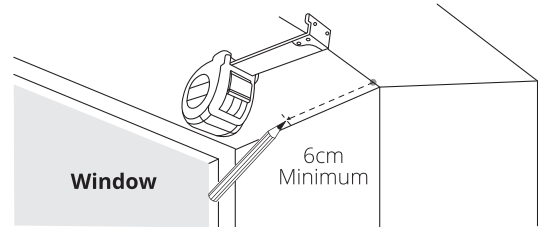

At the top-right corner of the window, measure how deep you wish to place your bracket (at least 6cm required), and make a mark with your pencil. Repeat this step at the top-left corner of the window, using the same depth measurement.

Set your motor bracket in the window so that the back edge aligns with your mark. Hold the bracket in position and use your pencil to mark through the top screw holes. Repeat this step with your pin bracket on the left side of the window.

Pre-drill holes with a 0.2cm drill bit at your previous marks on each side of the window.

Line up each bracket with the holes you drilled, and insert the screws. Once you have secured both brackets, you're ready to mount the shade into the window.

### ◆ EXPOSED ROLL

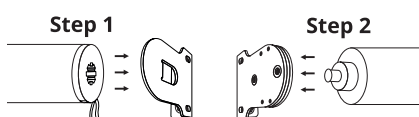

While holding the roller shade in your hands, locate the gear-shaped hole in the motor head on the right end of the shade. Slide this hole firmly onto the tab of the motor bracket.

Locate the pin on the left end of the shade, and gently slide it into the center slot on the pin bracket.

**Inside Mount:** Use a tape measure to check that each bracket is set to the same depth. If you need to make adjustments, slightly loosen the screws on a bracket and shift it back or forward. Secure the screws when the position is corrected.

**Outside Mount:** Use a tape measure to check that each bracket is set to the same height, and use a level on top of each bracket to make sure they're all straight and aligned. If you need to make adjustments, slightly loosen the screws on a bracket and shift it until it's level and set to the correct height.

# MOTORIZED Casette / Pelmet

## Installation Guide

### ◆ CASSETTE HEADRAIL OUTSIDE MOUNT

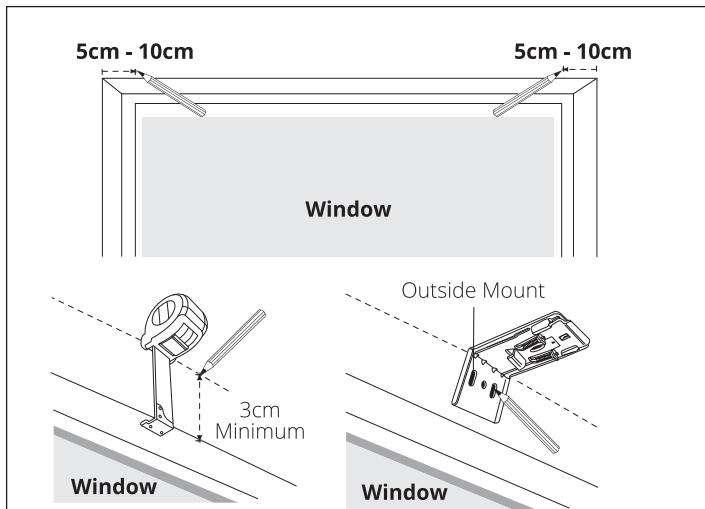

At the top corners of the window, measure inward and mark with your pencil 5cm - 10cm from each side. If you have additional brackets, make an additional mark for each one, evenly spaced between the outer marks.

From one of these marks, measure upward and mark the height for the bracket placement. The minimum requirement is 3cm, but if you want the brackets to clear the top of the window, measure and mark at least 6cm above your window. Repeat this until you've marked the same height measurement for each bracket.

Position a bracket so that the back is against your mounting surface, and the top is aligned with one of your upper marks. Hold the bracket in place and mark with your pencil where the screws will go. Repeat this until you've marked the screw holes for each bracket.

Pre-drill the screw holes with a 0.2cm drill bit at your marks for each bracket location. Before you mount the brackets, you may want to erase any pencil marks that remain on the mounting surface.

Line up your first bracket with the screw holes, and insert two screws to secure the bracket to the mounting surface. Repeat this step for any remaining brackets. When all brackets are secure, you're ready to mount the shade into the window.

### ◆ CASSETTE HEADRAIL INSIDE MOUNT

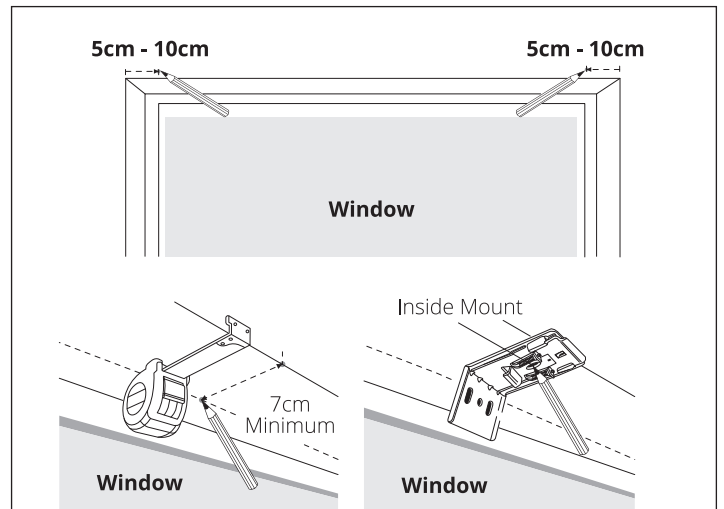

At the top corners of the window, measure inward and mark with your pencil 5cm - 10cm from each side. If you have additional brackets, make an additional mark for each one, evenly spaced between the outer marks.

Next, you'll need to measure how deep to place your brackets in the window. Starting at one of your marks, measure back at least 7cm, and make a mark with your pencil. If you want the front of the cassette to be flush with the wall, measure back 8cm and make a mark. Repeat this step until you've marked the same depth measurement for each bracket.

Position a bracket at the top of the window so that the back aligns with your mark. Make sure the front end of the bracket is parallel with the top edge of the window, then use your pencil to mark where the screws will go. Repeat this step until you've marked the screw holes for each bracket.

Pre-drill the screw holes with a 0.2cm drill bit at your marks for each bracket location. Before you mount the brackets, you may want to erase any pencil marks that remain on the wall or window.

Line up your first bracket with the screw holes, and insert two screws to secure the bracket to the mounting surface. Repeat this step for any remaining brackets. When all brackets are secure, you're ready to mount the shade into the window.

### ◆ MOUNTING CASSETTE HEADRAIL BRACKETS

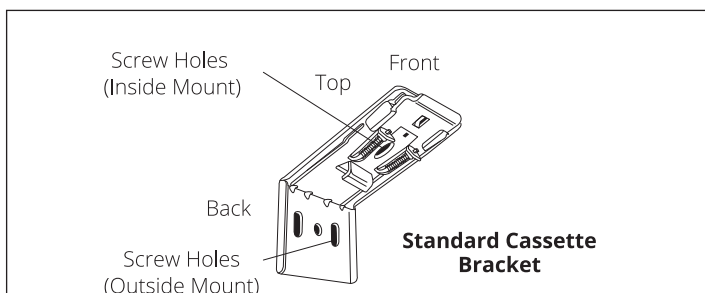

The roller shade tube is pre-installed in the cassette headrail, which simply snaps onto the provided hardware. You will receive two or more cassette brackets, depending on the width of your shade. **STANDARD CASSETTE BRACKETS** are included for cassette headrails 96" wide or smaller.

### ◆ STANDARD CASSETTE HEADRAIL

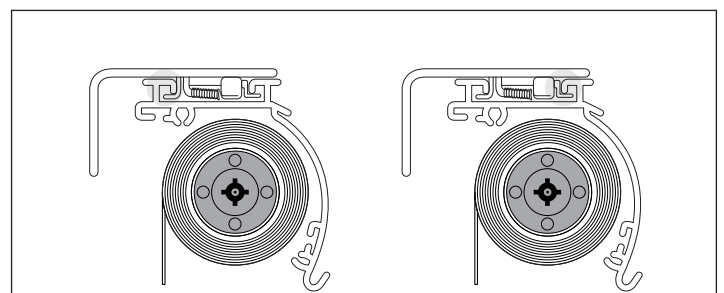

Grab the cassette and hold it up to your brackets. Set the back edge of the headrail onto the bottom tab of each bracket. While in this position, you can slide the shade left or right until the cassette is centered.

When you're ready to secure the headrail, push the headrail back until the top of each bracket snaps onto the top of the cassette.

### ◆ PROGRAMMING & USING YOUR REMOTE

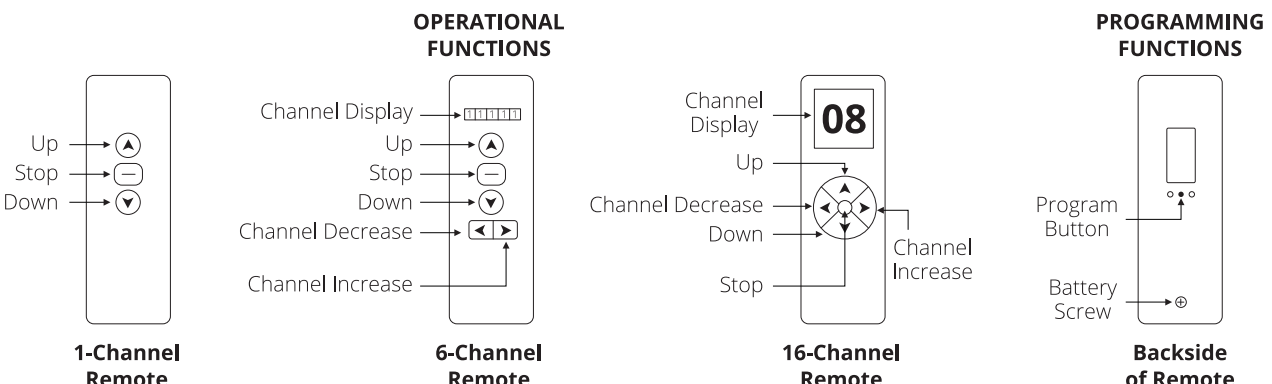

**OPERATIONAL FUNCTIONS**

**1-Channel Remote**

- Up
- Stop
- Down

**6-Channel Remote**

- Channel Display
- Up
- Stop
- Down
- Channel Decrease
- Channel Increase

**16-Channel Remote**

- Channel Display (08)
- Up
- Down
- Channel Decrease
- Channel Increase
- Stop

**PROGRAMMING FUNCTIONS**

**Backside of Remote**

- Program Button
- Battery Screw

**\* CONTROLLING MULTIPLE SHADES SIMULTANEOUSLY**

- 6 Channel Remote :** Press the channel increase button on the remote until all 6 lights on the channel display are illuminated. This activates all six channels simultaneously, which allows you to control up to 6 shades at the same time.
- 16 Channel Remote :** Press the channel increase button on the remote until you see "CC" on the channel display. This activates all sixteen channels simultaneously, which allows you to control up to 16 shades at the same time.

### ◆ PAIRING A SINGLE SHADE TO A CHANNEL

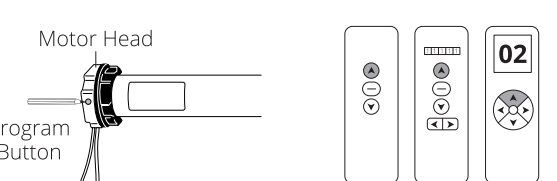

Press the **CHANNEL INCREASE** or **CHANNEL DECREASE** button on the remote to select a dedicated channel for the first shade you're pairing with the remote.

Locate the **MOTOR HEAD** on the left end of the roller tube under the headrail. Press and hold the program button until you hear a beep and the shade "jogs" quickly up and down.

Press the up button on the remote and the shade will jog again. Your shade and remote are now paired. Repeat this process for any additional shades you want to pair with the remote, selecting a new channel (if using a multi-channel remote) before you begin.

### ◆ ADJUSTING THE UPPER / LOWER LIMITS

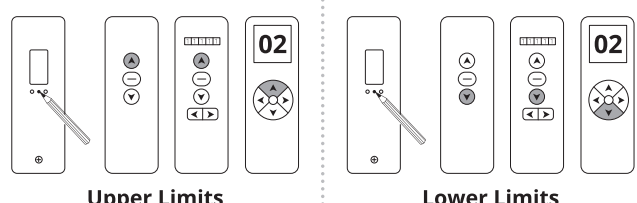

Press the **PROGRAM** button on the back of the remote. The shade will jog, indicating it's now in programming mode.

Press the **UP** button to move the shade to the desired upper limit. Press the program button on the back of the remote again and the shade will jog.

Press the **DOWN** button to move the shade to the desired lower limit. Press PROGRAM on the back of the remote again and the shade will jog.

Now reset your shade's upper limit, and the motor will exit programming mode automatically.

### ◆ SETTING INTERMEDIATE POSITIONS

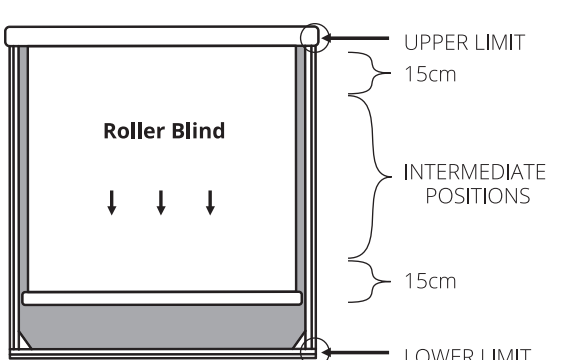

UPPER LIMIT  
15cm

INTERMEDIATE POSITIONS

15cm

LOWER LIMIT

You can set up to four intermediate positions between the shade's upper and lower limits. Each intermediate position must be at least 15cm away from the upper and lower limits, and any other intermediate limits you program.

Move the shade using the **UP** or **DOWN** buttons until it's at least 15cm away from any other limits.

Press the PROGRAM button on the back of the remote. The shade will jog, indicating it's now in programming mode.

Use the **UP** or **DOWN** button to move the shade to the desired stopping position and press the program button again. The shade will jog, indicating the new stopping point is now set.

Repeat these steps to add up to four intermediate stopping points to your shade.

# MOTORIZED Roller Blinds

## Other Setup Instructions

### ◆ DELETING LOWER LIMITS & INTERMEDIATE POSITIONS

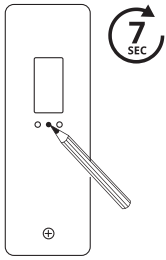

To delete a specific shade position, use the **UP** or **DOWN** buttons to move the shade to the position you want to remove.

Press and hold the **PROGRAM** button on the back of the remote for about 7 seconds. The shade will jog once before the 7 seconds and once after. You have now deleted the limit / position from your shade.

### ◆ PERFORMING A FACTORY RESET

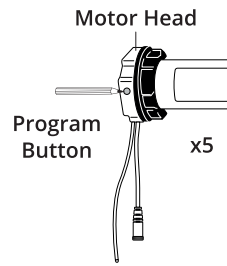

Press the **PROGRAM** button on the **MOTOR HEAD** four times in a row.

Press it again for a fifth time, holding the button down until the shade jogs twice.

Your shade's memory and all presets have now been erased.

### ◆ RECHARGING THE SHADE BATTERY

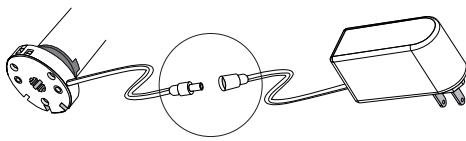

If the shade begins to move at a slower pace, the battery charge may be getting low. Plug the shade into a power outlet and charge the battery for 6 hours.

Locate the charger cable behind the fabric on the left side of the headrail. Connect this cable to the provided battery charger.

Plug the battery charger into the nearest wall outlet. If the cable isn't long enough to reach an outlet, use an extension cord (not included) to bridge the gap.

### ◆ REPLACING THE REMOTE BATTERY

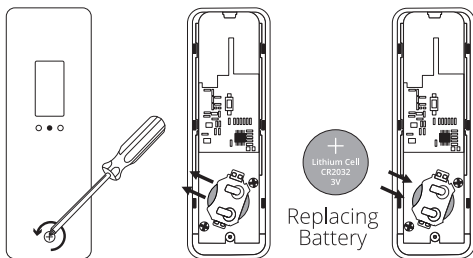

Back Cover

Inner Remote

Replacing Battery

The battery used to power your remote is a coin-shaped 3V cell battery (CR2032). Additional batteries are not included.

To remove the back cover of the remote, use a small screwdriver to remove the battery screw. Gently slide the back cover up to disengage it, then lift it away from the remote.

Remove the old battery from the circuit board by sliding it diagonally out of the bracket holding it down. Place a new 3V cell battery in the bracket with the "+" positive side showing.

Replace the back cover of the remote, and secure the battery screw.

### ◆ INSTALLING A WALL MOUNT CARRIER

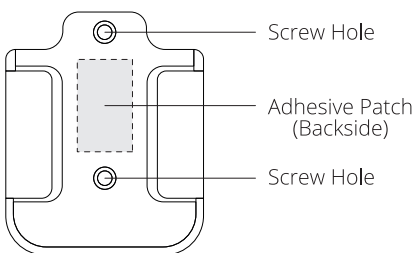

A wall mount carrier is included with your remote, but it is optional to install it. If you choose to mount the carrier with the adhesive patch on the back, be sure to clean and dry the mounting surface first.

Determine where you'd like to place your remote carrier in the room. It is common to place it near a light switch, or on the wall next to the window.

With the carrier in the upright position, insert the provided screws to secure it to our mounting surface. If you're using the adhesive patch, remove the backing and firmly press the carrier to the clean surface for about 30 - 45 seconds.

### ◆ CLEANING INSTRUCTIONS

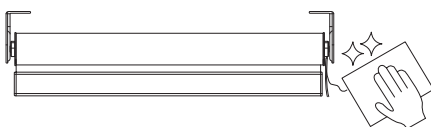

For regular maintenance, use a duster or a vacuum with a brush attachment and run it over the front and back of the shade.

To spot clean stains, use a damp rag with a very mild, gentle detergent or soap. Dab at the affected spots. Let the dampened area air-dry and repeat as necessary.

### ◆ CHILD SAFETY WARNING

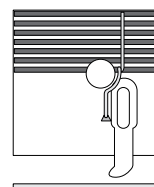

Corded window blinds and shades can be a strangulation risk or cause serious injury to young children and pets.

- Keep cords up and away from your child's reach.
- Always use cord cleats with corded products.
- Secure child-safe tensioners for continuous cord loop chains to the wall or window encasement.