

Z SERIES AGRICULTURAL DRONE SYSTEM

(Model: Z30/Z50)

User Manual

Version 1.0 EN



Contents

Disclaimer	2
Safety Guidelines	3
List of Items	5
Introduction	6
Pre-flight Preparation	8
Inspection	8
Smart Battery	8
Remote Control Introduction	10
Overview	10
Function Introduction	11
Description of Status Indicator	11
Touchscreen Introduction	12
Charging the Remote	12
Power On/Off Remote	13
Signal Range	13
Operating the Aircraft	13
Connection and Settings	14
Link to Aircraft	14
Remote Control Setup	16
Agri Assistant App	18
Home Screen	18
Account Registration and Activation	19
Operation View	22
Debugging Before Takeoff	23
RC Calibration	23
Gate Set	25

Sensor Calibration	25
Parameter Settings	27
Advanced Setting	30
Map Type	30
Pre-flight Test	30
Unlock/Landing	30
Motors Test	31
Nozzle Test	31
Spraying Operation Modes	31
Operation Mode Switch	31
Manual Operation Mode	32
Auto Operation Mode	33
A-B Route Operation	33
Fully Auto Operation	35
Switch Spreading System	39
Spreading System Debugging	39
Spreading Operation	43
Maintenance	44
Cleaning After Operation	44
Regular Maintenance	44
Transportation	46
Supplements	47
Automatic Return to Home (RTH)	47
Log Download	48
Alarm	49
Appendix	50
Specifications	50

Assembly Guide

For installation, please refer to the *Z Series Assembly Instruction Manual*. If you have not received it, please contact EFT official customer service to get it.

Videos

For detailed tutorial videos, please follow EFT Official Media Channel.

Website:

<https://www.effort-tech.com/en/home>

YouTube:

<https://www.youtube.com/channel/UC-8quK4ZYq2eFwwpXSx3NrA>

Download assistant software and firmware

The latest version information is available on remote control, you can update timely.

Manufacturer :

EFT Electronic Technology Co. Ltd.

Address: Building C2, Intelligent Technology Park, 3963 Susong Road, Shushan District, Hefei , Anhui, China.

Tel: 0551-65536542

Mail: infor@effort-tech.com

Web: www.effort-tech.com

Disclaimer

1. Please read User Manual carefully before using this product, as it has much to do with both operational safety and your legitimate rights and interests, whether you are a distributor or a user.

You shall be deemed to have read, understood, agreed and acknowledged all terms and conditions and information stated herein upon activation and use of the product.

2. This aircraft is not a toy, is NOT suitable for those who are under 18 years old, or those who have no or limited capacity for civil conduct, or those with mobility impairments, or those restricted by existing laws, regulations and policies. Please keep the product out of reach of children and be particularly cautious while there are children present.

3. Before using, please make sure that you have fully understood the characteristics and functions of the product, and ensure that you have the technical ability for the operation or have a professional team, and can take the failures risk to caused by improper installation and debugging.

4. **To protect your rights, please strictly follow the official EFT tutorials . We do not accept any return or exchange due to subjective factors,** such as subjectively determined that it is not easy to use, don't know how to use, and the performance does not meet the expected, which are non-product quality problems. All damages and risks from personal reasons during assembly and operation shall be borne by the users, we do not assume any related liability

5. **You understand that in the use of any products, accidents may occur due to single or combined factors, including but not limited to improper operation, surroundings and communication networks. You understand that the aforesaid accidents are reasonable and acceptable in the use of the product, and that EFT shall not be held accountable for such accidents.**

6. **Please do not disassemble, modify, retrofit or use the product for non-specified purposes.** All injuries and losses directly or indirectly caused by the above actions shall be borne by the users.

7. On any account, you shall comply with the laws and regulations of the country and the region where the product is used. EFT shall assume no liability arising from your violation of relevant laws and regulations.

8. To the extent permitted by law, EFT reserves the rights for final explanation and revision of the

terms and conditions here in above. EFT also has the right to update, modify or terminate these terms and conditions via channels including its official website, the User Manual and online App, without prior notice.

Safety Guidelines

- If you are a beginner ,it is recommended to finish the training courses ,or get assistance from veteran before flying, and supervised by a veteran during the flight.
- **Do not disassemble any module or disconnect any plug when the power is on.**
- **Please see that all parts and components are intact , and well installed and that those aging or broken are replaced promptly before each flight.** All devices should be sufficiently charged. When the battery gets low during operation, you should return the aircraft immediately and replace the battery.
- For safety purposes, it is advisable to remove all propellers before each flight or after firmware update until you have a test, inspect the remote control devices, motors and other modules and ensure everything is in order.
- Please charge the battery of the remote controller or aircraft when it falls to 20% to avoid damage to the device caused by overdischarge of the battery stored at a low charge state for a long time. By the same token, please keep the battery at 40%-60% when storing an idle aircraft. The storage area should be dry, wellventilated and clean.
- NEVER install/remove any module or insert/extract any circuit while the power is on.
- Please ensure that the aircraft does not carry a load beyond the safe takeoff weight specified in this *User Manual*. Overload, a safety hazard, is NEVER allowed.
- Never take human bodies or animals, whether still or moving, or other hazardous objects as obstacles in the obstacle avoidance experiment.
- If the radar modules and binocular vision system are unable to work properly in the operating environment, the aircraft will be unable to avoid obstacles during Return to Home (RTH). All that can be adjusted is the flight speed and altitude, as long as the remote controller is still connected.
- After landing, stop the motors, power off the aircraft, and turn off the remote controller. Otherwise, the aircraft may enter failsafe RTH automatically due to remote controller signal loss.

- **Speed limit \leq 15m/s, distance limit \leq 1000m, it is recommended that the flight height be 2.5m~3.5m from the top of the plant, please operate correctly within the safety limit.**
- **MOS smart battery is required.**
- Keep the product away from heat to prevent damage to the electronic component and other parts or fire incidents.
- For long-term storage or long-distance transportation, please remove the liquid tank from the aircraft and empty it, and store the aircraft in a cool, dry place.
- Recommended storage temperature (when the spray tank, flow meter, pumps, and hoses are empty): between 10° and 40° C.
- Pay attention to environmental protection when preparing and spraying pesticides. It is prohibited to pollute rivers and drinking water sources.
- Fly at locations that are clear of buildings and other obstacles. DO NOT fly above or near large crowds.
- Make sure that your operations do not violate any applicable laws or regulations, and that you have obtained all appropriate prior authorizations. Consult the relevant government agency or authority, or your lawyer before flight to ensure you comply with all relevant laws and regulations.

List of Items

Please check that all of the following items are present when unpacking the boxes.

Packaging form: CKD

Number of packages: 2 cartons

Items as below :

Drone body x1

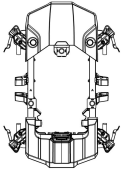

Spray tank kit x1

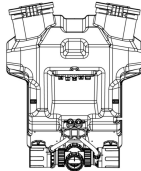

CW motor x2
CCW motor x2

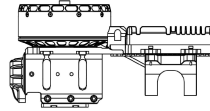

Arms x4



CW Paddle x2
CCW Paddle x2



Centrifugal nozzle x2



Rear crossbar x1



Front crossbar x1



Landing gearx2

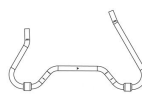

Camera x1

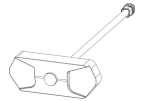

Landing gear mount
x4



paddle clip x4



Remote control bag x1

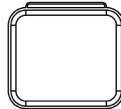

Bellows x2



Nozzle adapter cable x2



Mounting fittings

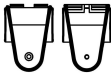
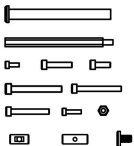

Lock nut x4

Hex studx4 Tee Fixing Pair x4

M3*8x2 M4*12x4 M4*10x12

M4*35x1 M4*30x4

M4*20x16 M3*16x8 M4Locknut

Short pin x4 Long pin x4 Lock screw x4 Gasket x8 Camera bracketx1

Three solutions are optional, as follows:

Item	Basic set	Advanced set	Standard set
Drone frame	√	√	√
Motor set*4	√	√	√
Impeller pump*2	√	√	√
Flowmeter	√	√	√
Liquid level gauge	√	√	√
Centrifugal nozzle*2	√	√	√
Switchboard	√	√	√
Piping fittings	√	√	√
Flight control	√	√	√
Receiver	√	√	√
Camera	√	√	√
Remote control	√	√	√
Rear radar	X	√	√
Front radar	X	√	√
Altitude Radar	X	√	√
RTK	X	X	√

Introduction

Aircraft Features

The Z series agricultural UAV system solution is a full configuration solution provided by EFT. It has two load models of 30kg and 50kg and is delivered in a semi-assembled form. It adopts truss structure and Z-shaped folding arms to minimize the folding volume and facilitate transportation. Equipped with double impeller pumps and water-cooled centrifugal nozzles , ultra-precision sensor, ultrasonic flowmeter, integrated spreading system.

IP67 waterproof from inside to outside, sealed waterproof plugs and sealed core modules, which can be washed directly. All parts can have closed-loop feedback by CAN protocol, early warning of faults, smart Auto operation, effectively prolonging the lifespan of the drone.

Aircraft Overview

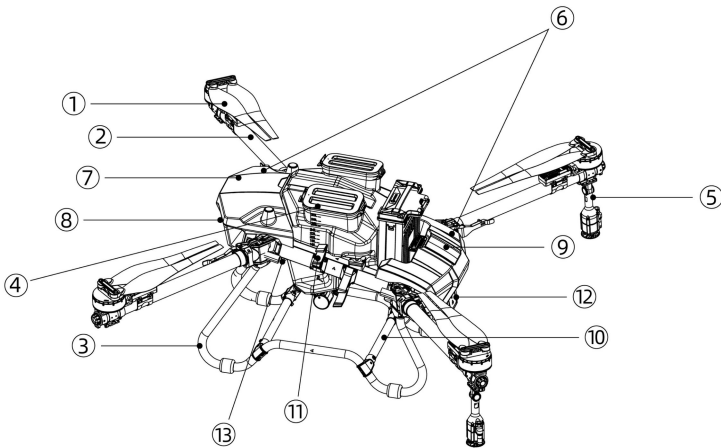

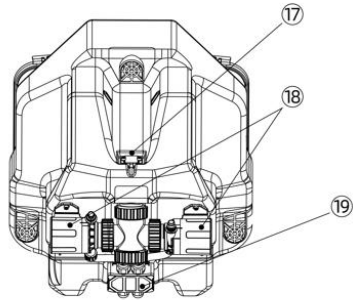
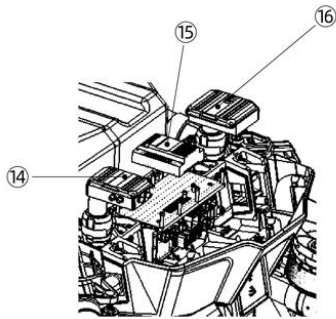

- | | | |
|----------------------|-------------------------|-------------------------|
| ① Motor set | ⑧ Camera | ⑮ Flight control |
| ② Arm (Φ50mm) | ⑨ Rear cover | ⑯ Receiver |
| ③ Landing gear | ⑩ Landing gear crossbar | ⑰ Level gauge |
| ④ Spraying tank | ⑪ Arm buckle | ⑱ Impeller pump |
| ⑤ Centrifugal nozzle | ⑫ Radar | ⑲ Ultrasonic flow meter |
| ⑥ Cabin | ⑬ Antenna | |
| ⑦ Front cover | ⑭ RTK | |

Pre-flight Preparation

Inspection

- Check whether the components are in good condition, especially the landing gear , the internal flight control and flow meter interface etc..
- Check the identification on the motors and propellers to ensure that the installation order is correct (CW—M2/M4, CCW—M1/M3).
- Check that all pins are not skewed and that the cables are properly connected.
- Check whether the arm and cover is locked, and whether the nozzle is installed firmly.

After a overall inspection, level the motors, then unfold paddles and ready for testing.

Smart Battery

Installation

The smart battery can be installed directly, insert battery until hearing a clicking sound, then lock

the clasp.

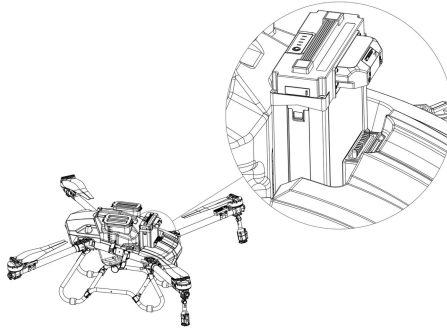

Warning

- Before installing the battery, please keep the interfaces at both ends clean, dry, no metal debris and liquid residue.
- Before starting the battery, please ensure that the battery is fully inserted to avoid flight accidents during operation due to the battery not being tightly connected.
- Make sure the battery power is off before inserting or removing the battery.

Power On

Short press the battery power button once, then press and hold it for over 2s, the 5 indicator lights will flash in sequence, and you will hear two beeps, indicating that the aircraft is powered on. Repeat the above steps to power off.

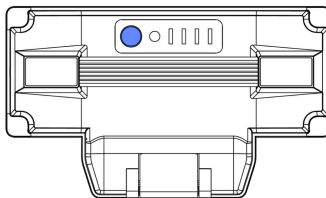

Remote Control Introduction

Overview

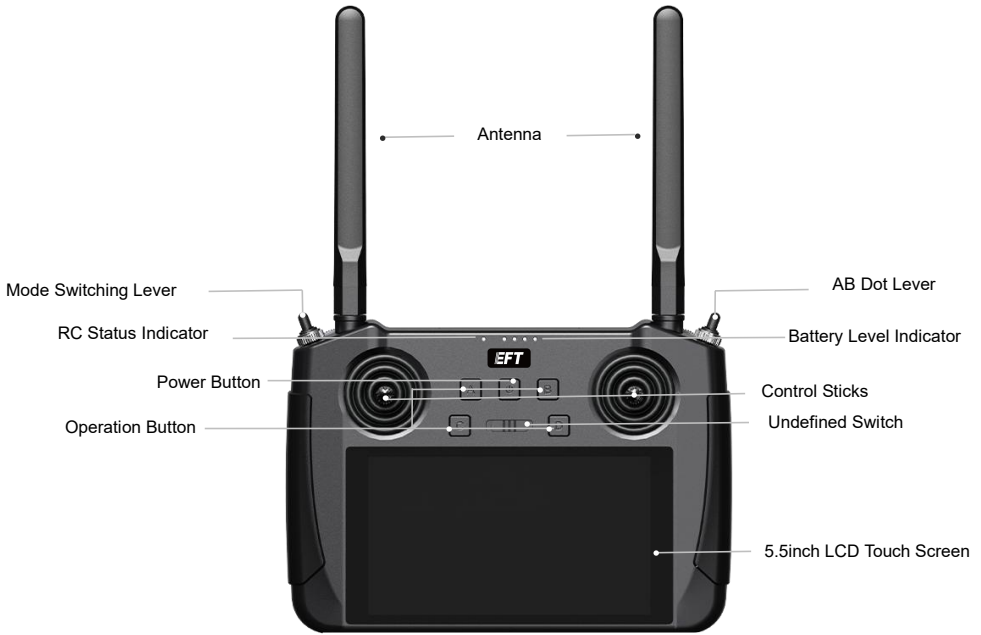



Function Introduction

- ① Left Dial: Undefined, can be customized.
- ② Top Left Lever: The flight mode switch of controlling aircraft (Attitude mode, Manual mode, Work mode).
- ③ Top Right Lever : In the AB mode, dot A point in the middle and turn up to dot B.
- ④ Left control stick : In American hand mode, Up is fly-up, Down is landing, Left is rotation to the left, Right is rotation to the right.
- ⑤ Right control stick : Up is going forward, Down is flying back, Left is left translation, Right is right translation
- ⑥ Right Dial: Undefined, can be customized.
- ⑦ A Button: Control the night vision lights of aircraft.
- ⑧ B Button: Turn on/off the obstacle avoidance radar.
- ⑨ C Button: Turn on/off the water pump.
- ⑩ D Button: Turn on/off the centrifugal nozzle.
- ⑪ Power Button: Turns on/off the power of the remote control.
- ⑫ Slide Button: Undefined, can be customized.

Description of Status Indicator

- ① Flashing red light (rapid) : Linking
- ② Alternately flashing red, green and yellow(slow): Image transmission is starting
- ③ Alternately flashing red and green : Android system shuts down abnormally
- ④ Flashing red light(slow) : Firmware mismatch
- ⑤ Flashing red light three times (slow) : Initialize image transmission failed
- ⑥ Flashing red light four times (slow) : The remote needs to be calibrated
- ⑦ Flashing yellow light (slow): The remote control power supply voltage is abnormal
- ⑧ Flashing yellow light twice (slow): Remote control bluetooth not recognized

- ⑨ ● Solid red light: Not communicating with aircraft
- ⑩ ●● Flashing yellow and red light : Level 1 alarm of remote control temperature
- Flashing yellow and twice red light : Level 2 alarm of remote control temperature
- Flashing yellow and triple red light : Level 3 alarm of remote control temperature
- ⑪ ●● Flashing green and red light : Level 1 alarm of receiver temperature
- Flashing green and twice red light : Level 2 alarm of receiver temperature
- Flashing green and triple red light : Level 3 alarm of receiver temperature
- ⑫ ● Solid green light : Signal is stable, information accepted 100%
- Flashing green light : The faster the flash, the worse the signal

Touchscreen Introduction

Home Screen

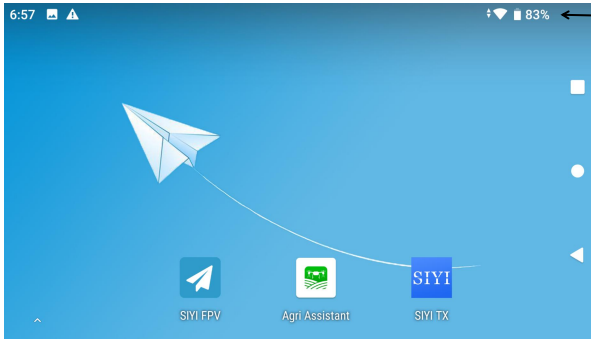

*The top bar displays the time, network status, as well as battery levels of the internal and external batteries of the remote controller.

Operations

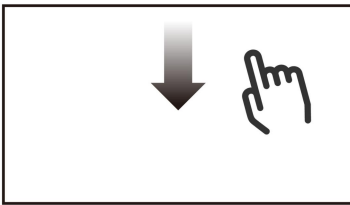

Enter the Quick Setting: Slide up from the bottom of the screen, reverse operation to exit this interface

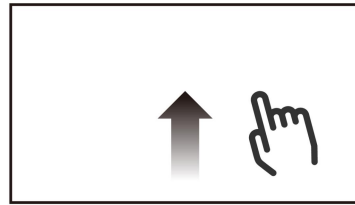

Enter the Multitask Center: Slide down from the top of the screen, reverse operation to exit this interface

Charging the Remote

The remote control needs to be charged with the original PD fast charger (Do not charge during operation).

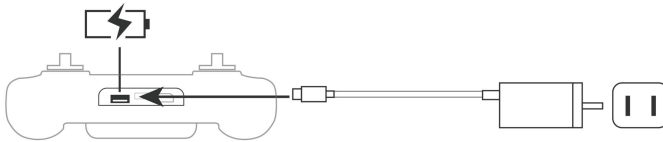

- ① Use Type-C fast charging cable with PD adapter.

- ② Solid red light of the indicator, it is charging.
- ③ Solid green light of indicator, it is fully charged.



Power On/Off Remote

The steps as below:

- ① Turn on : Short press the , then press and hold until a beep sound.
- ② Turn off : Pressing and hold , the interface will pop up three options: Power off, Restart, and Screenshot, tap the Power off to shutting down.

*Short press the  once to check the power of the built-in battery, if the power is low, please charge it.

Signal Range







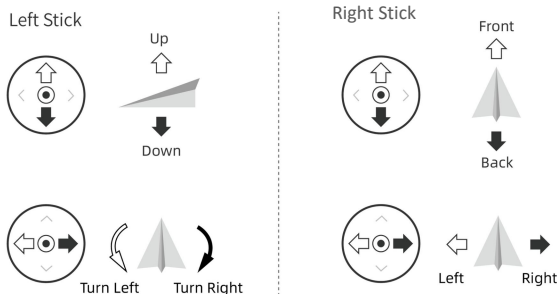

Unfold the antenna of the remote control and adjust it to a suitable position. The antenna positions will affect signal strength. Adjust the external antenna forward to the aircraft for better reception of signals. To ensure signal stability and flight safety, **it is recommended that the distance between the remote controller and the aircraft is not exceed 1000 meters.**

Operating the Aircraft

The operation mode of the stick is recommended “American Hand”. This manual takes “American Hand” as an example to introduce how to control the aircraft.



The following description of the American Hand mode:

Remote Controller	Aircraft (Indicates nose direction)	Remarks
<p>Left Stick</p> 		<p>Throttle Stick: Move the left stick vertically to control the elevation of the aircraft. Push up to ascend and push down to descend. Use the left stick to take off when the motors are spinning at an idle speed. The aircraft hovers in place if the stick is in the center position. The further the stick is pushed away from the center position, the faster the aircraft changes elevation.</p>
<p>Left Stick</p> 		<p>Yaw Stick: Move the left stick horizontally to control the heading of the aircraft. Push left to rotate the aircraft counterclockwise and push right to rotate clockwise. The aircraft hovers in place if the stick is in the center position. The further the stick is pushed away from the center position, the faster the aircraft rotates.</p>
<p>Right Stick</p> 		<p>Pitch Stick: Move the right stick vertically to control the pitch of the aircraft. Push up to fly forwards and press down to fly backwards. The aircraft hovers in place if the stick is in the center position. Push the stick further for a larger pitch angle and faster flight.</p>
<p>Right Stick</p> 		<p>Roll Stick: Move the right control stick horizontally to control the roll of the aircraft. Push the stick left to fly left and right to fly right. The aircraft hovers in place if the stick is in the central position. Push the stick further for a larger roll angle and faster flight.</p>

Connection and Settings

Link to Aircraft

Please follow the steps below to link the aircraft and the remote control.

1. Open SIYI TX App.

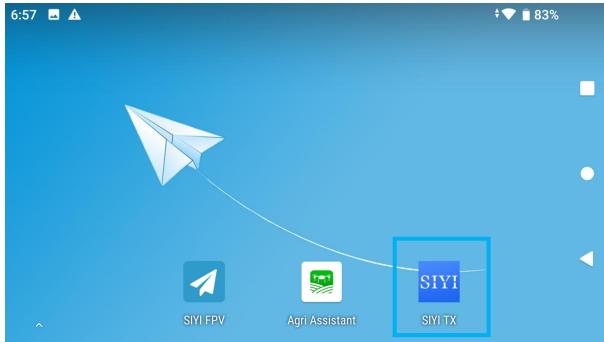

2. Click System.

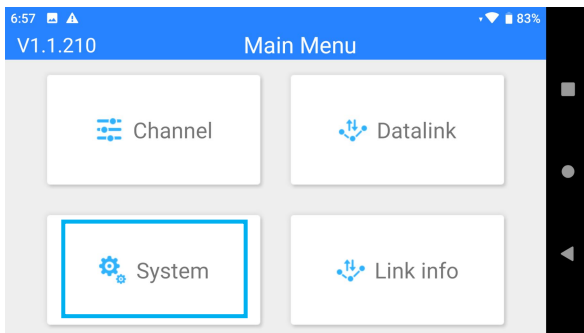

3. Click "Start" and set as below.

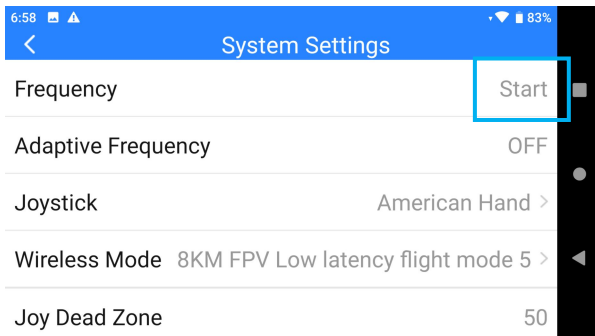

4. Press LINK button for 2s, flash green quickly to indicate that it is linking until turn to slow flashing, the linking is completed.

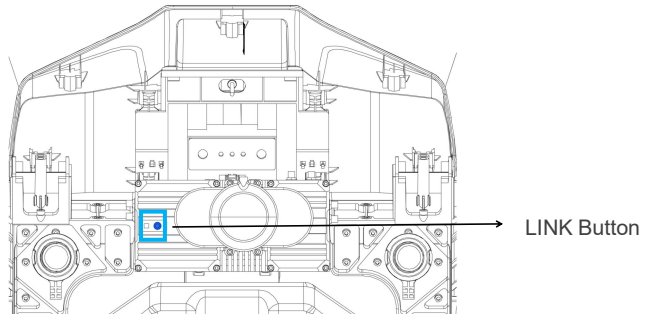

Remote Control Setup

Channel

Enter SIYI App, you can customize the channel settings. It is recommended to set channel 6 as SB gear lever, channel 7 to A, channel 8 to B, channel 9 to C, channel 10 to D, and channel 15 to A. Steps as below:

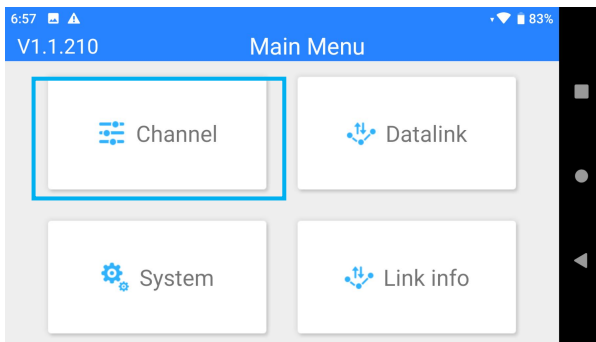

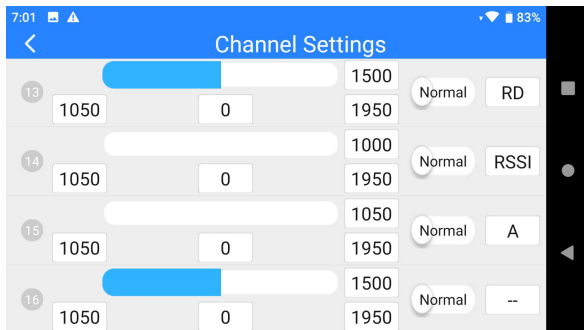
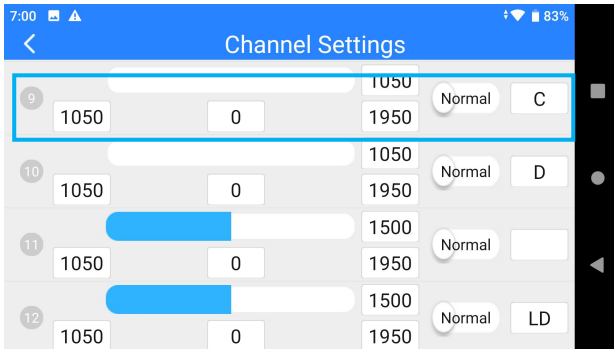
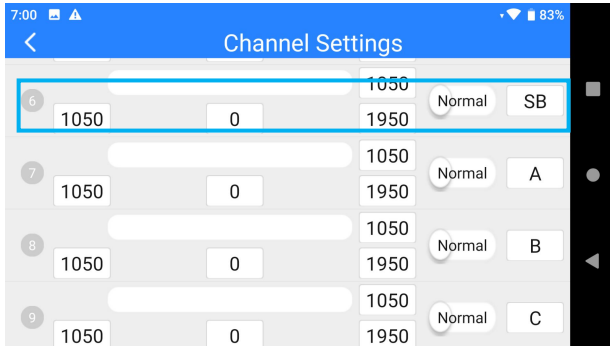

Datalink

Enter Datalink Setting, Device ID is automatic identification. Set the Connection to "UART", the

Flight Controller to "JIYI(K3-A)", and the Baud Rate to "57600". Then the remote setting is complete.

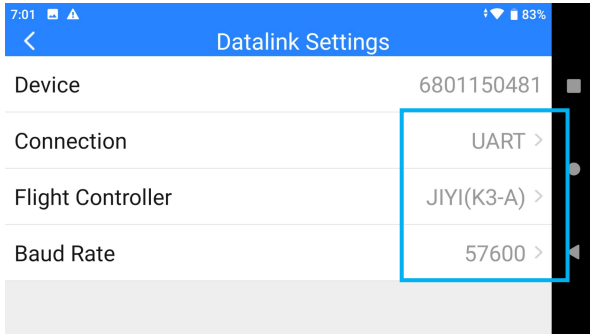

Agri Assistant App

Home Screen

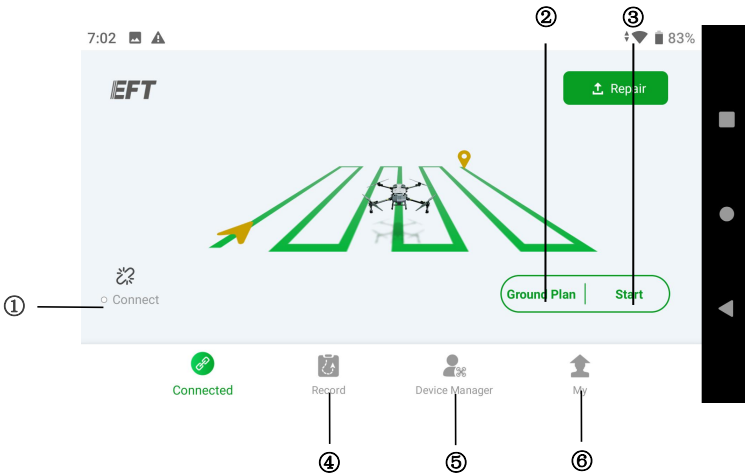

- ① Connect: Click to connect to the aircraft.
- ② Ground Plan: Click to add plot.
- ③ Start: Click to enter the aircraft operation screen.
- ④ Record: Click to view work list.
- ⑤ Device Manager: Click to view Plane List, Plane Add, Nofly Apply, Tool Management, RTK Base Station, Firmware Upgrade.

⑥ My: View user information.

Account Registration and Activation

1. Register

Open the latest Agri Assistant APP, click "Register". If you have the manufacturer account, you can directly enter the password to log in, and click "Connect". If the connection fails, you can directly click Start>•••Menu>•••About, select the remote control to "SIYI", then return to the home page, and connect again to succeed.

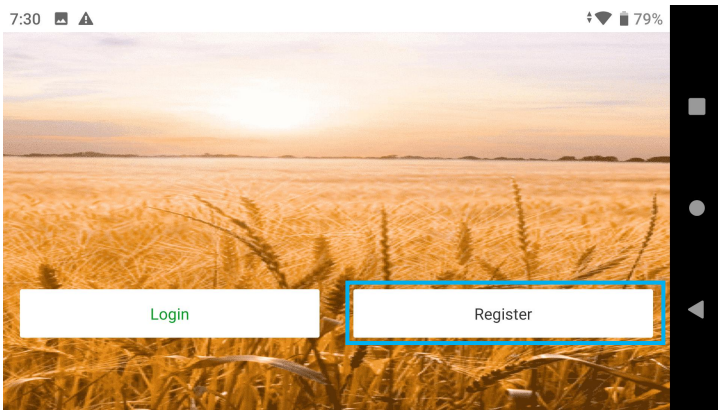

2. Verified

After logging in, select H12/MK15, click My  > Verified, fill in the information and upload the relevant certificates, wait for the verification, after verified, Click "Account Update", upgrade to the owner, manufacturer or seller according to the purchase agreement (Consult your direct supplier for any doubt).

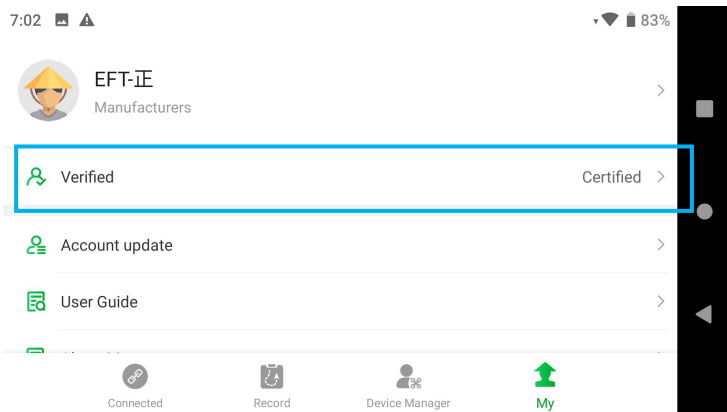

3. Plan Add

After the verification is successful, click Device Manager  > Plan Add, the Drone ID will be automatically identified, the Drone Name, Drone Type, and Drone Number can be customized , and fill in your direct supplier company to Manufacturers.

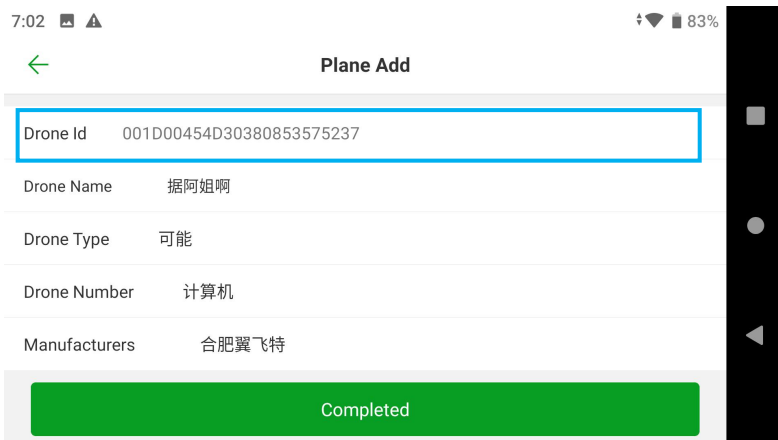

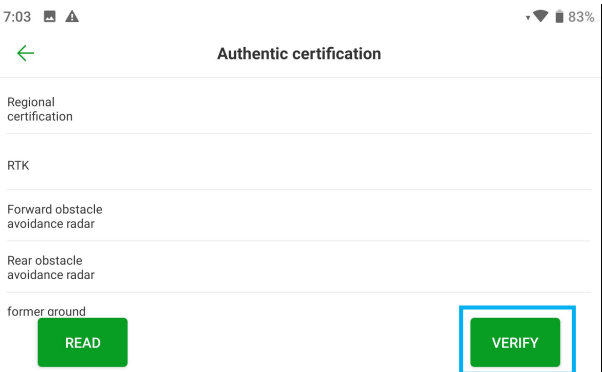
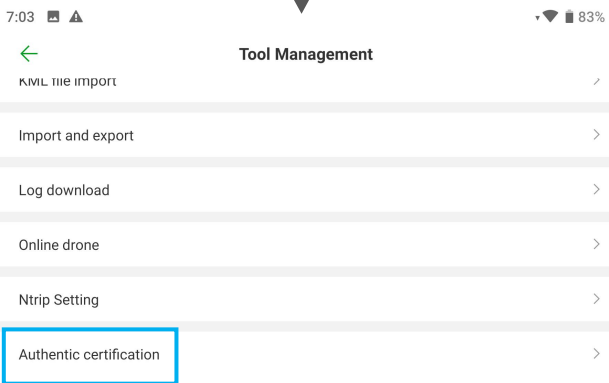
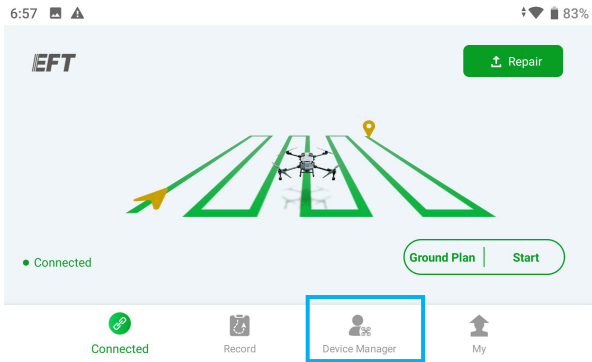

4. Activate Upgrade Account

Click Device Manager  > Tool Management  > Authentic Certification > Read > Verify, confirm the statuses are activated.



*Read First , Then Verify

5. Ntrip Setting

If you purchased RTK and is used outside of China, please click Device Manager  > Tool Management  > Ntrip Settings, and apply for an Ntrip account to log in. For the application method, please contact the local RTK Service provider.

6. Connect Aircraft

Back Home, Click  "Connect" > Start (choose H12/MK15) to enter the operation interface.

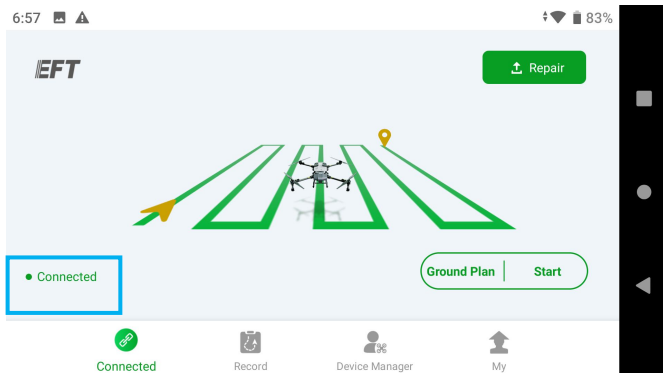

Operation View

View the aircraft status, set parameters, switch operation modes, plan a field, and perform operations.

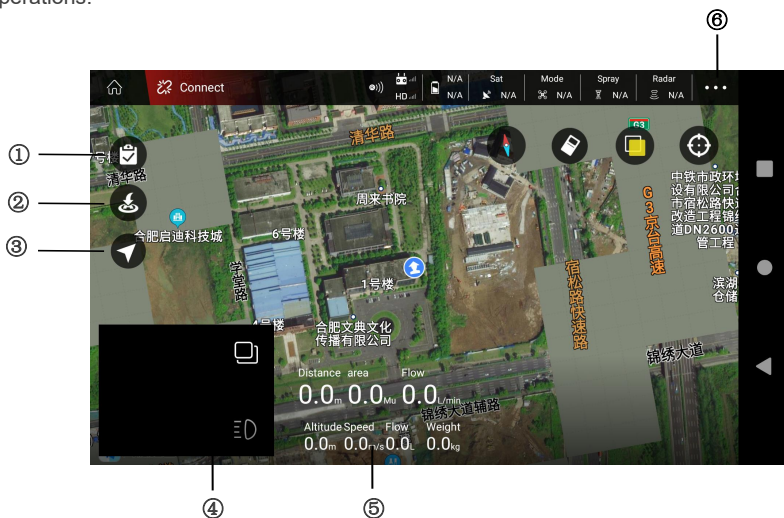

① Field List/Task Settings

Users can view the planned fields and the operations being executed.

② Switching between AB Route Operation Mode and Auto Operation Mode

③ Return to the Home Point

Slide the icon to the specified position according to the interface instructions.

④ FPV Camera View

Display the live view from the FPV camera. Tap to switch between the Map View and Camera View.

⑤ Flight Telemetry and Operation Status

Altitude: Within 15m, it is the relative height of the altitude radar. Over 15m, it is the relative height of the GPS.

Distance: Display the horizontal distance from the aircraft to the Home Point.

Speed: Display the flight speed of the aircraft.

Flow: Spray flow.

Area: Display the area values related to the task area.

Flow: Display the liquid flow rate from pump.

Weight: The weight of the liquid medicine in the tank.

⑥ Setting

●●● Tap menu to view and adjust the parameters of all other settings.

 RC Settings: Include linking and calibrating, control stick mode and customizable buttons setting, SUBS signal switching, failsafe setting.

 Aircraft settings : Include the settings of sensor , battery, spray , and flight parameter .

 Extra mode : Include smart battery, terrain following radar, J-RTK, obstacle avoidance module, K-BOX, Dot device, spreading settings, seed manager, arm alarm, J-Box etc.

 Advanced setting: Include Basic settings, Sensitivity, Spray, Radar etc.

●●● About: Include FC, Flight time Map type, Remote control type, Main style etc.

Debugging Before Takeoff

RC Calibration

 Please make sure the aircraft is linked to the remote controller before debugging.

Click Start > ●●● > , slide to the bottom of the page, read first, then debug individual items, and save. Click "RC calibration" to calibrate the left and right sticks in turn, and confirm that the stick operation is normal.

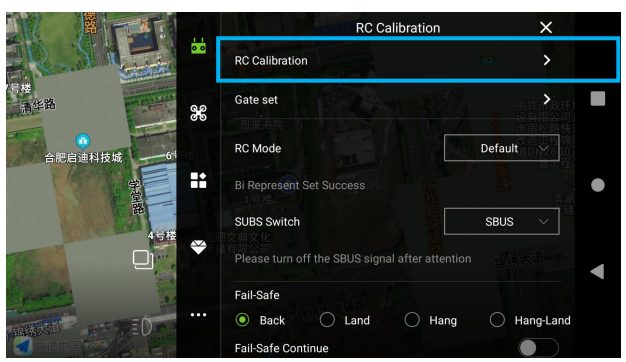
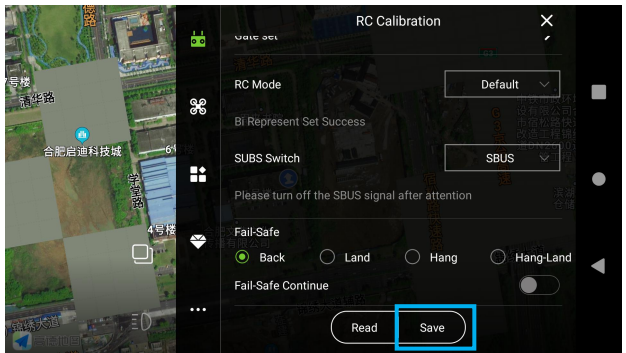
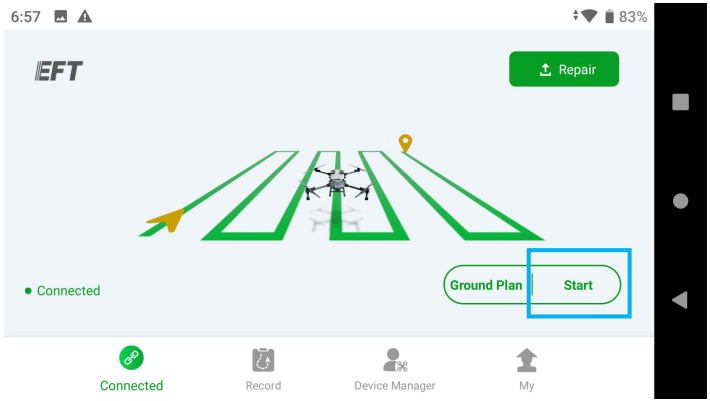



Gate Set

Channel Settings can be read directly from default settings CH 6 as AB, CH8 as Avoid, CH9 as Pump, CH10 as Engine. It can also be customized based on local operation habits. Then “Save” and the RC mode set as “American hand”.



Sensor Calibration



All new drones should do Accelerometer calibration and Compass calibration.

Accelerometer calibration

Enter Agri Assistant > Start > ●●● > 🚁 > Parameters Settings > Sensor, place the aircraft horizontally, click “Accelerometer Calibration”, and it will take 3~5s to auto complete calibration. If the ground is uneven, or the body is shaken, please re-calibrate.

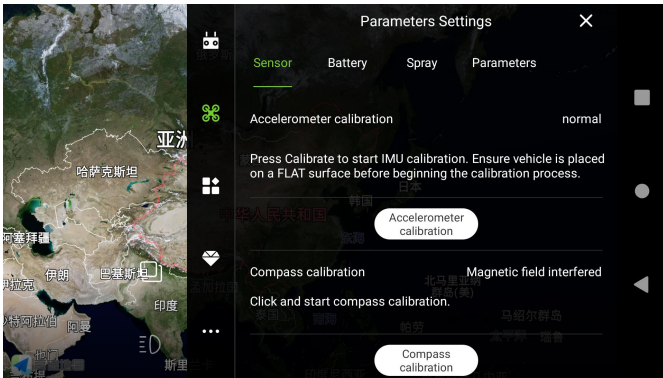

Compass calibration

Click "Compass calibration", check the instructions on the screen, when it indicates "doing x, the level of uniform rotation", lift the aircraft up and rotate it horizontally until it indicates "doing z, the nose down uniform rotation", then press the instruction to point the drone head down and continue to rotate until it indicates "Compass calibration normal", then put down the aircraft.

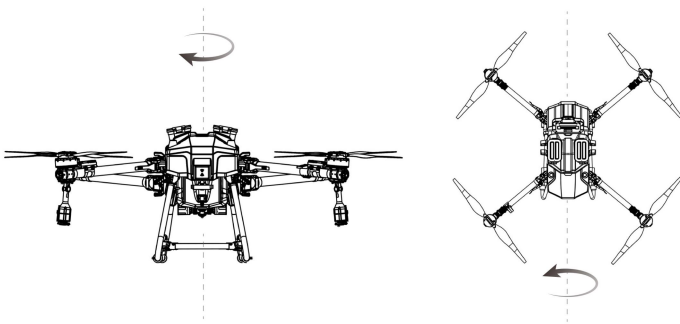

Flowmeter calibration

Enter Agri Assistant > Start > ●●●> >Parameters Settings >Spray, slide to the bottom, click Flowmeter Calibration and follow the steps below:

- ① Pour about 15L of water to tank;
- ② Turn on the water pump, until the water comes out ,then off the pump immediately;
- ③ Prepare two empty pails, weigh and record them, and place the two pails under the two centrifugal nozzles;

- ④ Click on the flow meter to calibrate, stop it before finishing the water spray;
- ⑤ Measure the weight of each pail one by one, subtract the net weight of the pail, and input the amount to channel 1 and channel 2 respectively (Facing the tail, channel 1 on the left and channel 2 on the right), then click OK.

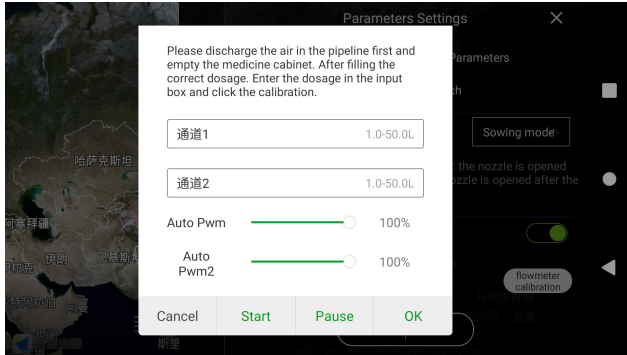

Weight Calibration

Enter Agri Assistant > Start > ●●● > ■■>Seed Manager > weight calibration. First, empty the tank, and click Peeling Calibration. It is recommended to add 15L water, click Weight Calibration and enter the known weight (1L=1000g), and then return to the operation screen to check the weight data, if it is 15kg, the calibration is successful.

*Note: The weighing objects should $\geq 10\text{kg}$

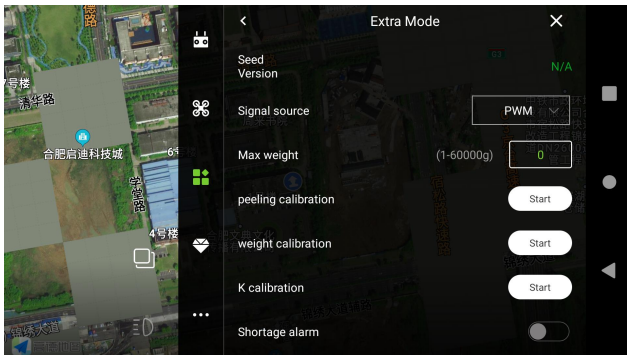

Parameter Settings

1. Spray

Enter Agri Assistant > Start > ●●●>✈>Spray. It is recommended to set Liq protection to Back, Liquid Type to Flow meter, Level Type to Switch. If the liquid level gauge going wrong, it can be adjusted to the flow meter mode. Select the Work mode accordingly and save it.

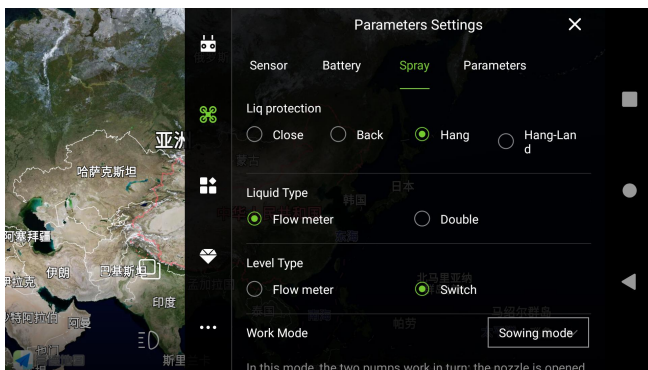

2. Flight Parameters

Enter Agri Assistant > Start > ●●●>✈>Parameters, slide to the bottom and click to read, and the default parameters will appear automatically (If there is no special requirement, please keep the default). Then set Course mode to Target, Back head Direction to “Tail to home”, and Save it.

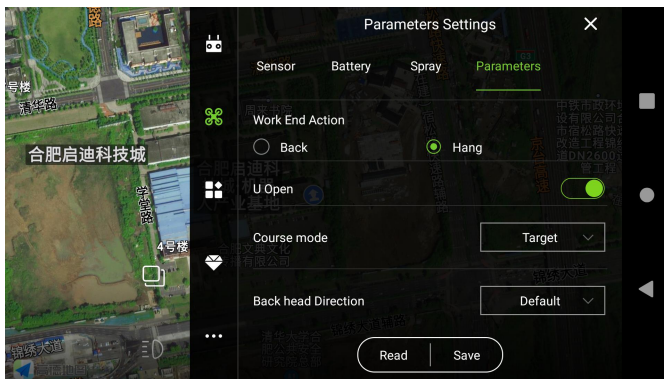

3. Extro Mode

Enter Agri Assistant > Start > 📶, check each module in turn, slide to the bottom, Read the data and Save it, check whether the parameters can be read normally. Please note: RTK trust is selected by default, if there is no RTK service, RTK trust set as “Low” and use GPS for

positioning. The EXT2 Type in K-Box set as “K-BOX4”. Dot Device, Seed Manager, Arm alarm etc. can be set according to needs.

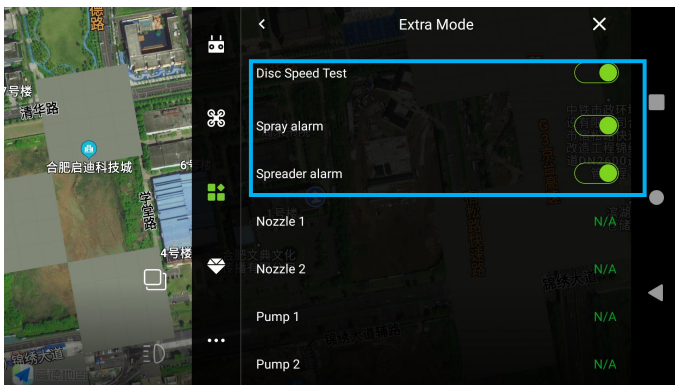
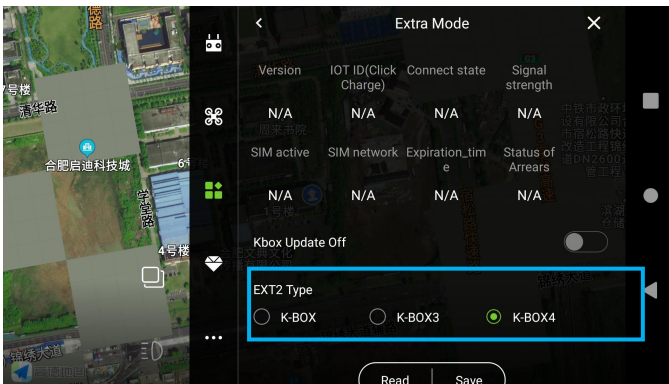
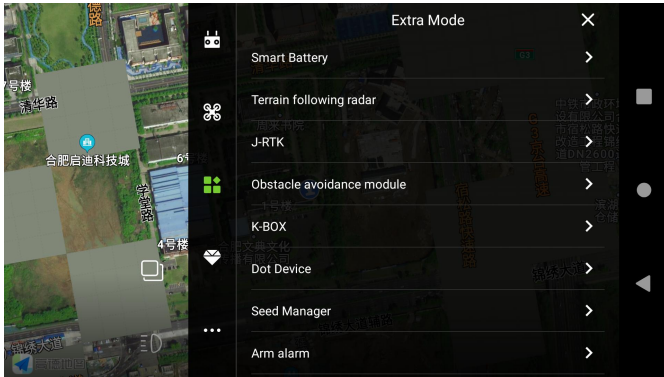

Advanced Setting

The advanced settings are generally defaulted by the factory, and the settings can be directly read and save. Please keep default settings. If the flight is unstable, you can contact the after-sales service to get the guidance.

Map Type

Enter Agri Assistant > Start > ●●●>●●●, Choose Map type setting as “Google Maps” to complete the pre-flight debugging.

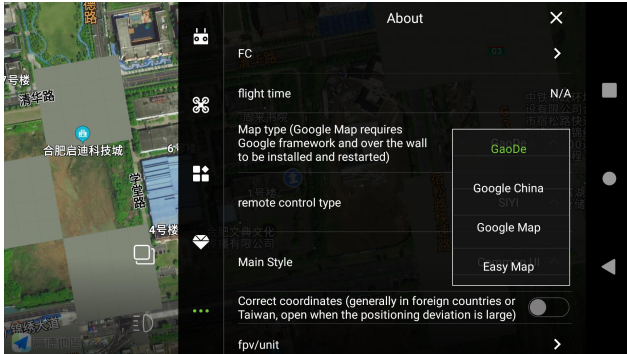

Pre-flight Test

Unlock/Landing

Unlock

Perform a Combination Stick Command(CSC) and stay for a few seconds. After the motor starts, release sticks and take off. If unlock fails, repeat the CSC 3 times until successful.

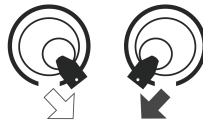

Landing

When the aircraft has landed, push and hold throttle stick down, the motor will stop after 3s.



⚠ Note

- Stay away from spinning propellers. Do not start the motors in narrow space or where there are people nearby.
- Keep controlling of the remote controller during the motors work. Do not stop the motors during flight to reduce the risk of damage or injury.
- After landing, power off the aircraft before turning off the remote controller.

Motors Test

After starting the motor, operate the right stick to perform the following actions:

- ① Dial it up, the front two motors stop rotating.
- ② Dial it down, and the rear two motors stop rotating.
- ③ Turn right, the right two motors stop rotating.
- ④ Turn left, the left two motors stop rotating.

The above steps can check if the motors work normally.

Nozzle Test

In the spray mode, press C and D buttons to turn on the water pump and the nozzle respectively. Check if it can work normally.

Spraying Operation Modes

Spraying operation modes include Manual, A-B Route, Auto Operation Mode. Select the desired mode for spray according to the application scenarios.

Operation Mode Switch

The aircraft is in attitude mode by default, and the aircraft can only be unlocked and taken off in attitude mode. Three operating modes are optional: Attitude, Manual, and Auto.

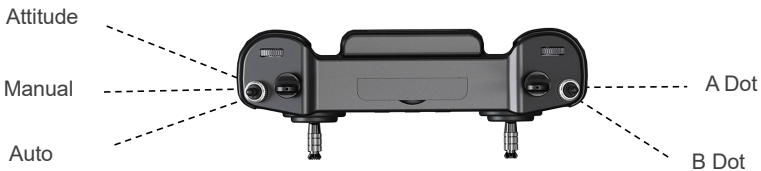

- ① Auto: Move the left lever to the front position.

- ② Manual: Keep the left lever in the middle.
 - ③ Attitude: Move the left lever to the rear position.
 - ④ AB: The middle position of the right lever is point A, and the front position is point B.
- (*With RTK, the aircraft can hover precisely, achieve centimeter-level positioning. Without RTK, the aircraft is positioned by GPS)

Manual Operation Mode

1. Click Agri Assistant >Connect > H12/MK15 >Start



2. Tap “Spray” in the top information bar, set Spray Type to “Spray Auto”, set the Hec Dosage as needed, then adjust the Disc speed and Disc speed 2 to 100%, then switch Spray type to “Spray Manual”, tap screen to confirm. Take off the aircraft in the Attitude Mode, fly to the field, switch to the Manual Operation Mode, then operate the aircraft by sticks, press C and D to spray.

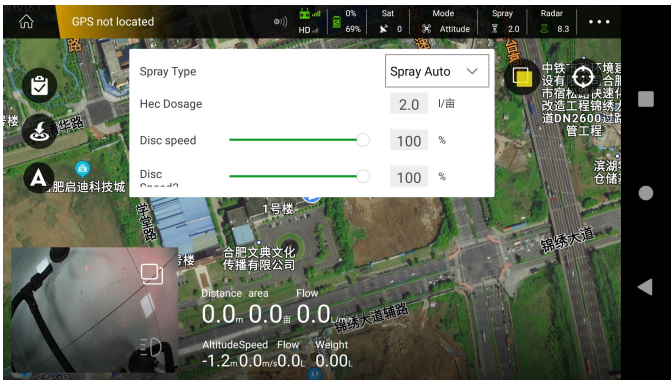

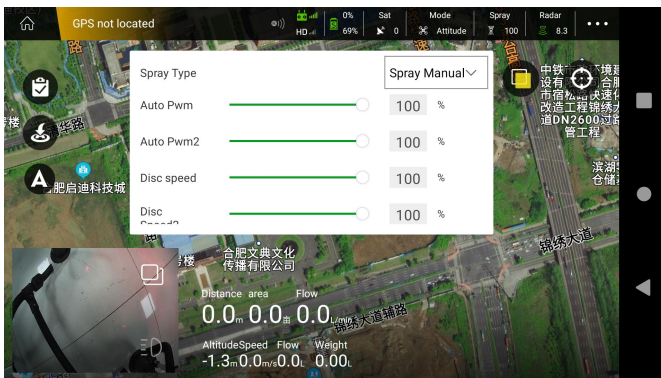

Auto Operation Mode

A-B Route Operation

Two methods can enter the AB operation mode:

Method 1:

1. Click Agri Assistant >Connect  > H12/MK15 >Start
2. Complete the preflight inspection and unlock for takeoff in Attitude Mode.
3. After takeoff, fly to the field where you want to work. After the aircraft stabilizes, click “A” to enter the AB operation mode. Click the A near your side to add point A. Detailed flight parameters will appear on the screen. Set the parameters, then push the stick forward, fly the aircraft to the other side of the field and click “B” to add point B.
4. After adding point AB, click “Start”, then choose “To the left” or “To the right” then the aircraft can automatically identify the planned route.

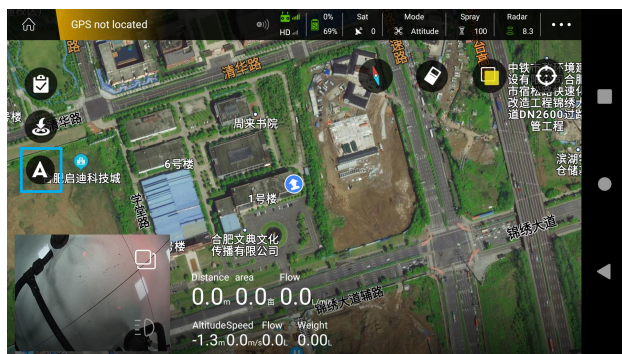

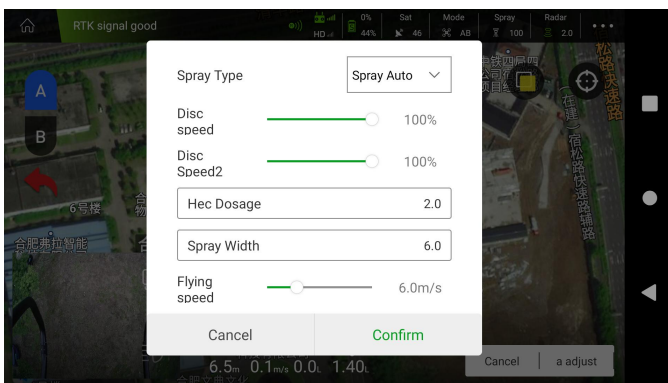
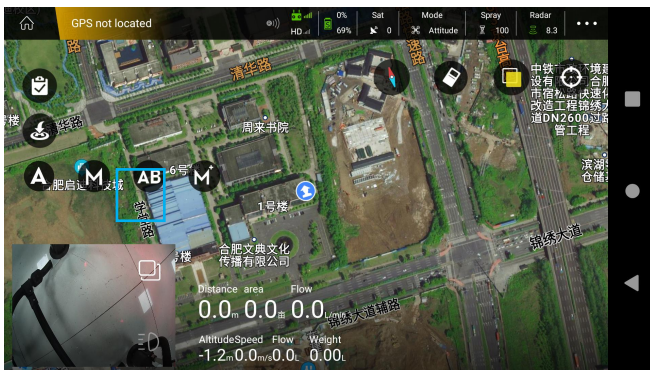

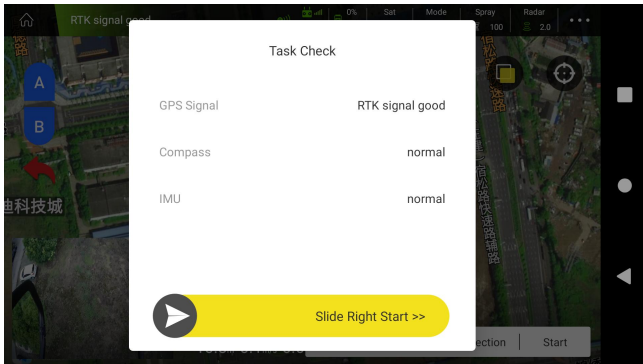

Method 2:

1. Fly to the field where you want to work. After the aircraft stabilizes, move the left lever on the side close to you. Switch Attitude to Auto mode, and then fly to the A position to add point A , the detailed flight parameters will appear on the screen. After setting the parameters, push the lever forward, fly the aircraft to the other side to add point B.
2. After adding point A and B, fully push the right stick to the left or right, and the aircraft can automatically identify the planned route.

Fully Auto Operation

1. Click Agri Assistant >Connect > H12/MK15 >Ground Plan > New Plot.

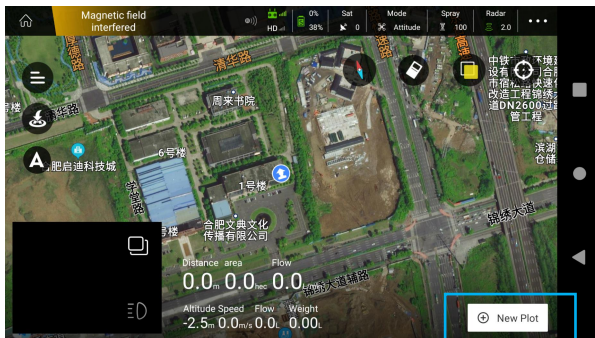
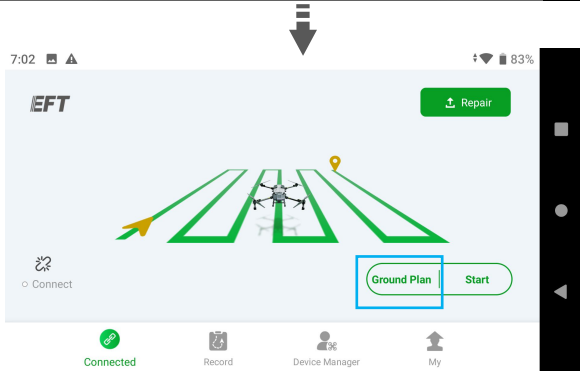
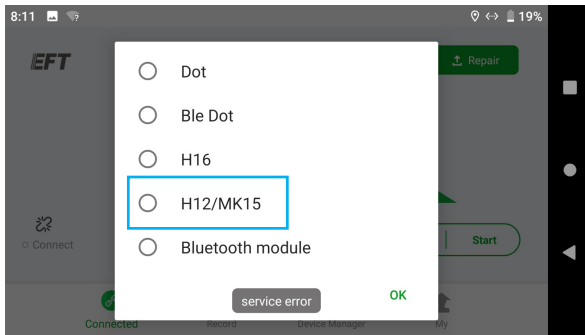

2. Select the planning method ①Handheld GPS(RTK point device) ②Flight GPS ③Map Selection ④Waypoint planning. Method ① and ② are widely used.

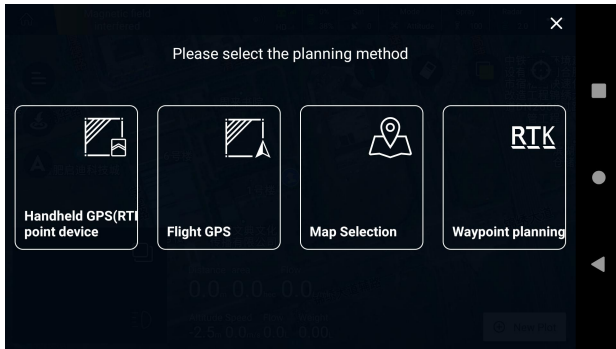

3. Set Ground Name, move the handheld point device or fly the aircraft to the field, click the Boundary Point on the right side of screen to add dots in turn.

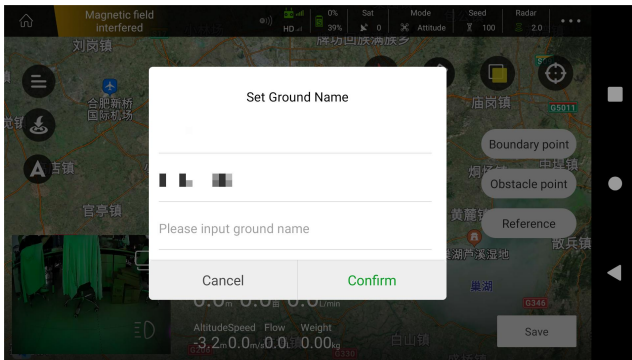

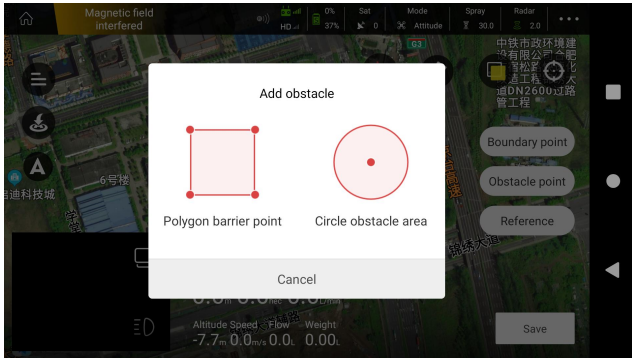
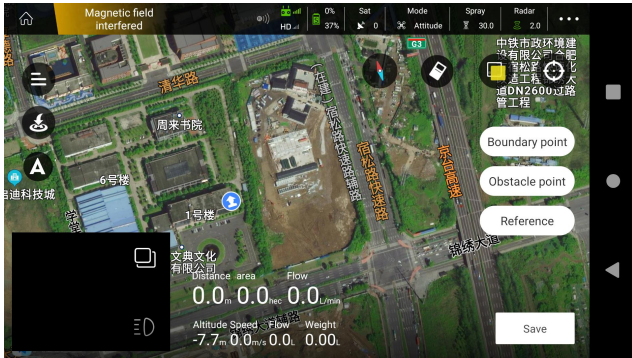

4. About obstacles, move handheld point device or fly the aircraft to the obstacles, click Obstacle Point. There are two methods to mark it, Polygon barrier point and Circle obstacle area. Note that if you select Polygon barrier point, use the Boundary Point to dot. Handheld RTK point are recommended.

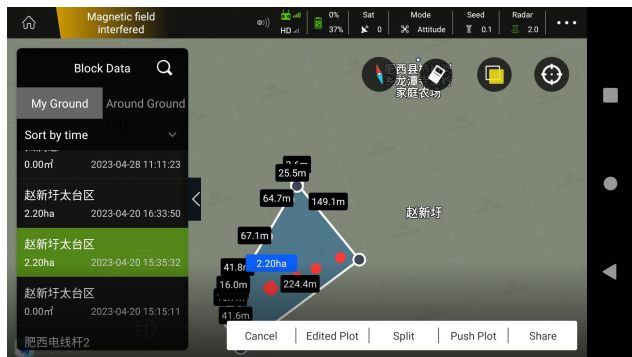

5. Click "Save" after all operations are done, tap  on the left, select the newly saved plot, click Share > Confirm, the plot information is listed in Block Data.

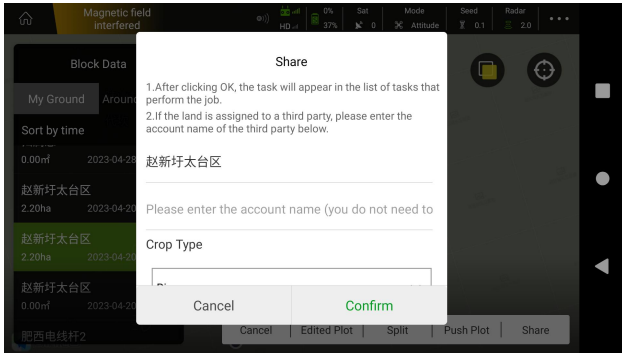



6. Tap , select the plot, adjust the route and click "Start", then check the parameters according to prompt. Click Confirm and Slide Right Start to take off.

Switch Spreading System

*Note: The spreading system is optional.

Please refer to the *Z Series Assembly Instruction Manual* for installation.

Spreading System Debugging

1. **Sowing mode**, click Start>•••>>Spray> Work Mode, switch the work mode to Sowing mode. Press the C and D keys to test the speed of the spreader and the valve.

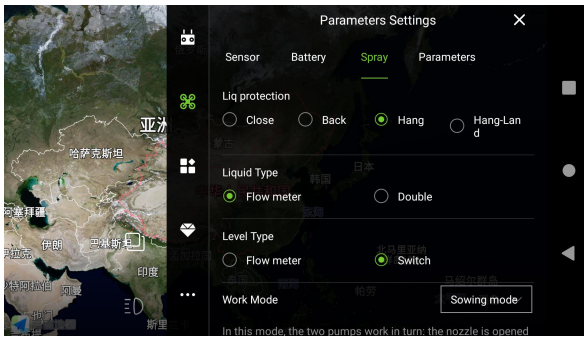

2. **Weight Calibration.** Click ●●●> Seed Manager> Peeling Calibration, wait 3s, check the display of the remote control, if weight is 0, peeling calibration is finished. Then Click “Weight Calibration”, pour objects (over 10kg) into the tank, enter the measured weight , click “Save” and wait 3s, check the weight display, if it is the same as the known weight (The error range is 0.02kg), calibration is done. If it fails, please re-calibrate.

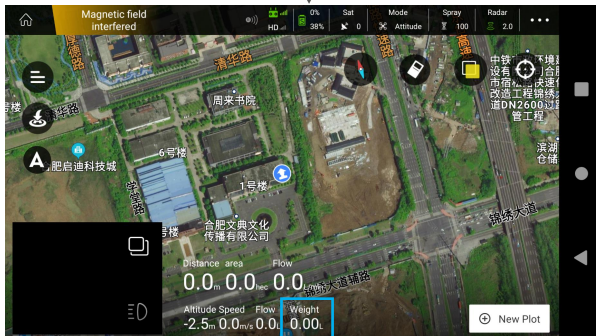
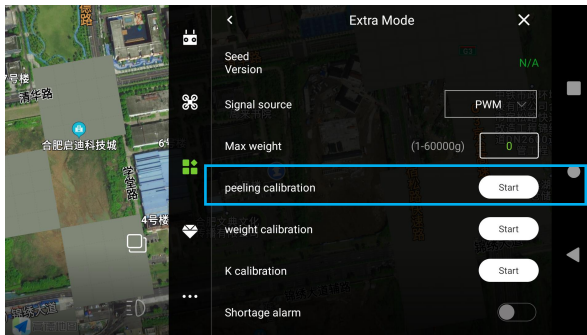

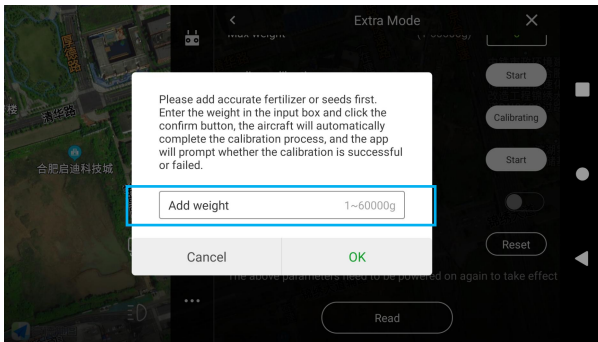
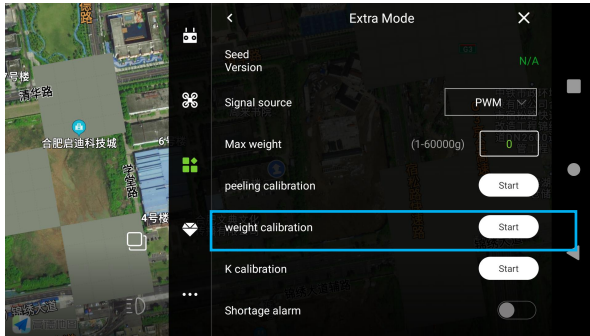

3. Click "Spread" in the top bar, set Sowing mode to "Precision sowing", Template Selection to "Create", enter the object name, set the parameters, such as the Hec Dosage, Disc speed, Flying speed, etc., then "Save".

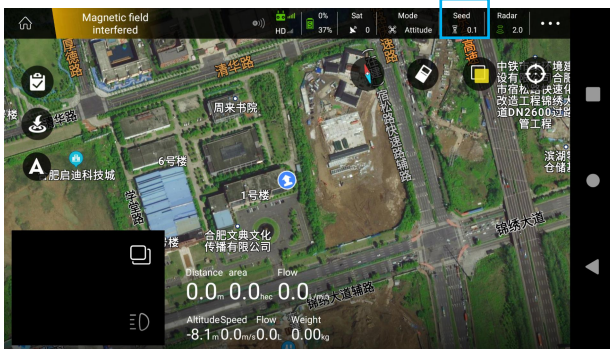

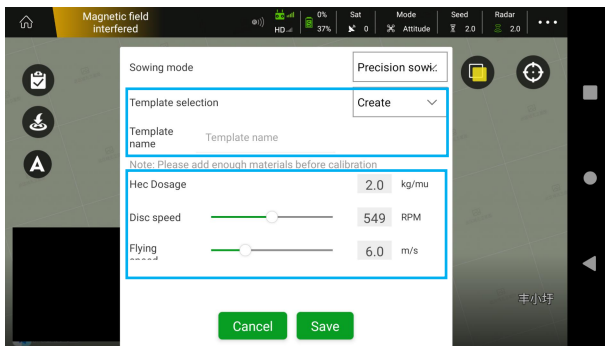
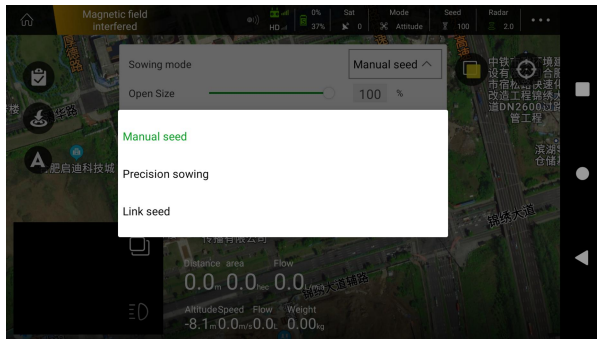

4. Enter "Spread" again, select the newly created template, remove the spreader turntable. Add at least 15KG object, click "Flow calibration" to complete the spreading debugging.

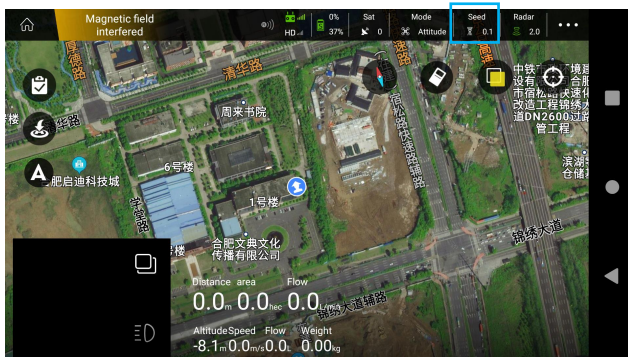

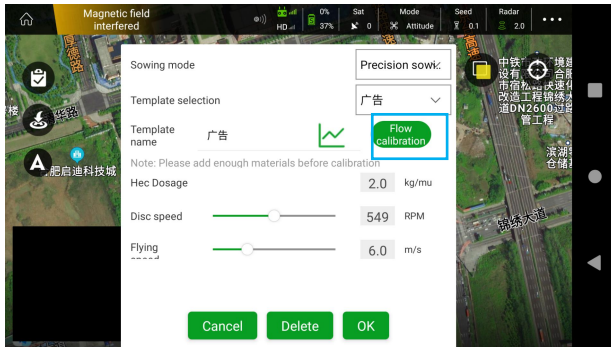

Spreading Operation

1. Open the Agri Assistant App, select Ground Plan >New Plot>Map Selection>Set Ground Name, circle the plots, then “Share”.

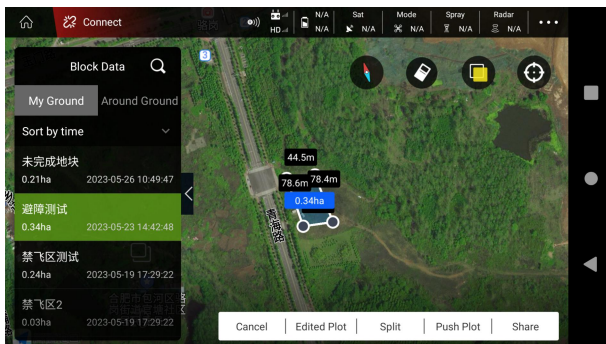

2. Click , select the plots, set Hec Dosage, Disc speed, Flying speed and other parameters, Click Confirm and Slide Right Start to take off.

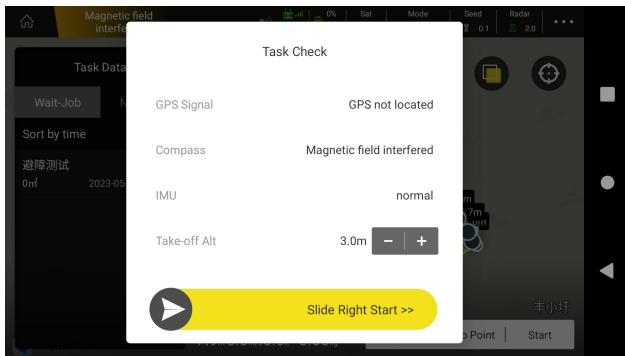
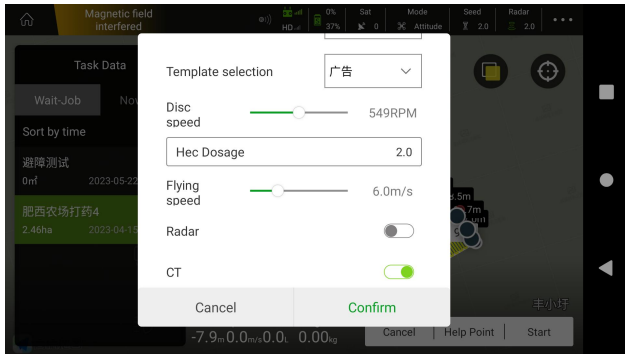

Maintenance

Cleaning After Operation

Clean the device timely after each operation to prolong life-span. Follow the cleaning steps:

Detergent: soapy water or laundry powder.

- ① Fill the tank with soapy water or the laundry powder. Start spraying to clean pesticide residues in the spraying system.
- ② Fill the tank with clean water and start spraying to wash off residual soapy water or the laundry powder in the spraying system. Place the empty tank in the aircraft and start spraying until all pipes are drained, avoiding damage to other devices during transportation or storage.
- ③ Wipe the surface of the aircraft to remove potion stains and mud. Empty the tank and drain the pipes if the aircraft needs to be transferred or will not be used for an extended period.

Regular Maintenance

Wear and tear as well as malfunctions in/of the device could occur as a result of ordinary use.

Regular maintenance ensures that the device performs at its best in future operations with fewer malfunctions and improved efficiency. Maintenance steps are as follows:

A. Drone frame

- ① Check if any screw on the frame is loosening or missing.
- ② Check if the components including landing gears, fuselage, arms, motors and antennas are in good condition.
- ③ Check if the connectors of each component are firmly in position, whether they have oxidized, and if the battery plug is deformed.
- ④ Check breakages and cracks on the frame and components. Check if the beams of the aircraft are bent out of shape or broken, if the fasteners joining the arms and motors together are secure, if the arms are bent and twisted, or if the locking handle is intact.
- ⑤ Clean the aircraft regularly and thoroughly, especially those hard-to-clean spots including the liquid tank socket and battery plug on the frame.

B. Propulsion System

(1) Propellers

- ① Check if propeller clamps are cracked or deformed and if the blades are loosening, damaged, bent out of shape or softened.
- ② Check if the blades and clamps are properly joined.
- ③ Check if the setscrews holding the clamps and motors are missing or loosening.
- ④ Wipe the propellers clean with a damp rag.

(2) Motors

- ① Remove the propellers and clean the motors with an air blow gun.
- ② Rotate the motors and check whether the bearings wobble or make noise.
- ③ Check if the enameled wires of motors are broken.
- ④ Gently rock the motors and see if they are firmly fixed on the motor mounts.
- ⑤ Check the connectors and cables between motors and ESCs.

(3) ESCs

- ① Remove the power plugs of the ESCs and check if the metal parts are deformed or oxidized.
- ② Check if the setscrews on the ESCs are missing or loosening.
- ③ Check if fouling such as pesticide deposits occurs in the heat dissipation part of the ESCs.

C. Spray System

The spraying system needs to be calibrated once it has a large error (outside of plus or minus

5%) due to chemical corrosion, thick pesticides, replacement of peristaltic pump parts, etc. Calibration needs to be done with clean water or pesticides used in operation. In case the health index remains unusual after calibration, check whether the peristaltic pump tubes or spray tubes are in good condition. Replace them in time if they shrivel, lose their elasticity or are out of shape.

(1) Impeller Pump

- ① Open the impeller pump, check the wear between the impeller and frame, replace them in time if they damage.
- ② Check if the pump connectors have come loose or oxidized, etc.

(2) Tank

- ① Check the sealing ring of the liquid inlet.
- ② Unscrew the cap and check if the inner tubes are in good condition.
- ③ Unscrew the filter and clean the dirt off it.

D. Power System

(1) Battery

- ① If the battery is not used for an extended period, charge and discharge it every three months to keep it active.
- ② When the battery is swelling, leaking, deformed, or having exterior damage, immediately stop using it.
- ③ Do not charge the battery in a damp environment.
- ④ Do not insert or remove the battery when it is turned on, or its socket could be damaged.
- ⑤ Handle the battery with care. Never take it apart without permission.

(2) Power Socket

With dust, liquid, or other foreign objects sticking to the power socket, poor contact, short circuits or sparking could occur in the connection of the battery, charger or socket. Before and after the use of the power device, users should check and clean each component including the battery plug and socket, ensuring that the power socket remains clean, dry and free of foreign objects.

Transportation

Propeller blades of the aircraft should be folded and fastened by clamps for transportation. Loop the safety belt through the handles of the drone frame mounting brackets to fasten the aircraft on the carrier.

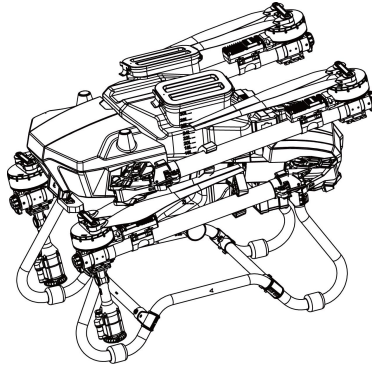

Note

- Before transporting, clean and empty the spraying system and drain all tubes to avoid damage to other devices during transportation.
- Pesticide packaging and sewage must be collected for proper disposal to avoid hazards.
- Never place batteries in the aircraft for transportation.
- During transportation, do not drive while tired. Devices should be stored separately with good air circulation to avoid poisoning by inhalation of pesticides.

Supplements

Automatic Return to Home (RTH)

The aircraft has smart RTH, low battery RTH, failsafe RTH, etc.. Low battery RTH and failsafe RTH can be set to RTH or Hover.

Home Point: The default home point is the location when the aircraft takeoff.

RTH: RTH brings the aircraft back to the last recorded home point.

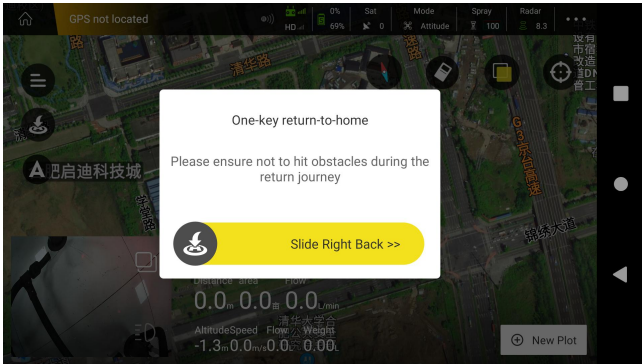

Log Download

1. Open Agri Assistant >Device Manager>Tool Management>Log Download, select the log to be downloaded. Click "share", recommend to share to the Files, return to the Home screen, in the multitasking center, find the logs shared , you can link the remote control via bluetooth or data cable to share to other devices.

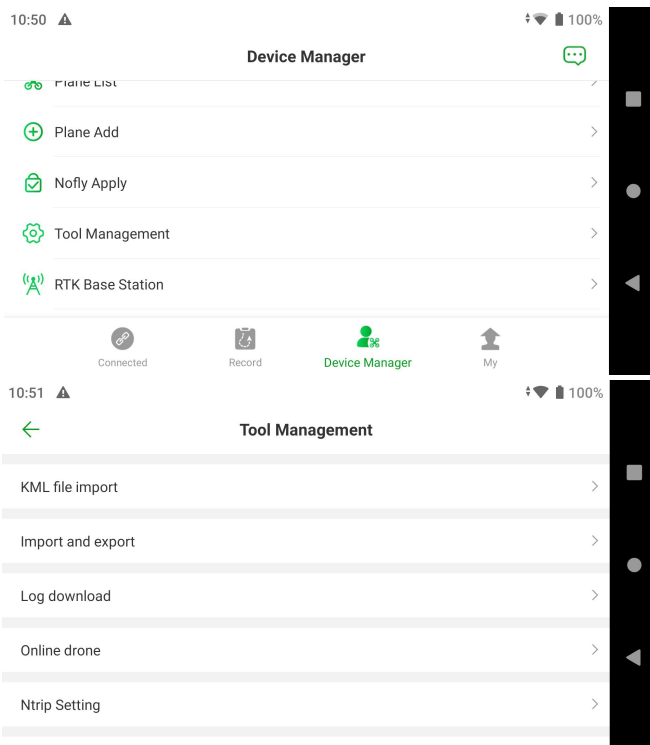

Alarm

There are two methods to get alarm information:

Method 1: Open Agri Assistant, click My>Alarm Message, check the prompts during operation from the Alarm List, you can modify it according to the suggestions.

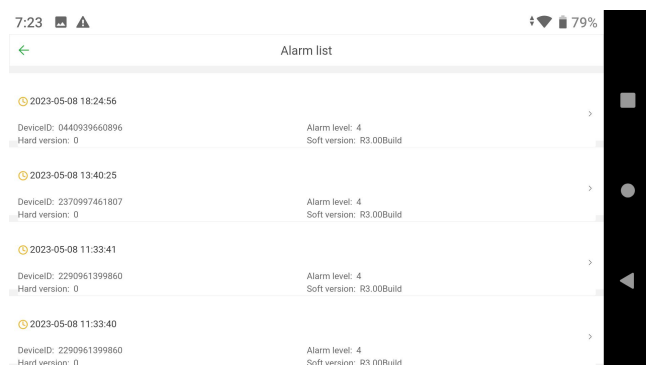

Method 2: When the aircraft has connected, select Agri Assistant >Start, click the device management bar in the upper left corner, get alarm prompt information in Sensor Status.

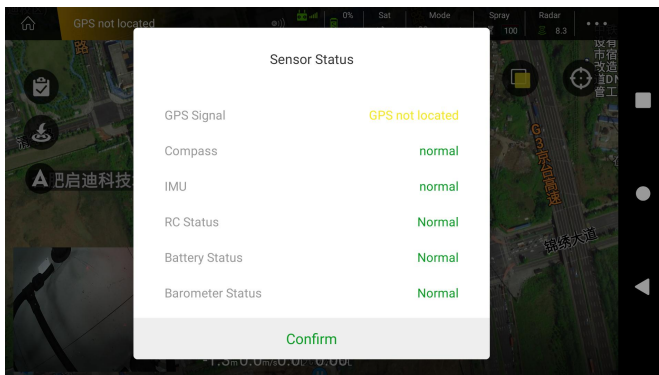

Appendix

Specifications

Item	Parameter	Z30	Z50
Drone system	Unloaded Spraying drone weight (without batteries)	29.8kg	31.5kg
	Unloaded Spraying drone weight (with batteries)	40kg	45kg
	Unloaded Spreading drone weight (without battery)	30.5kg	32.5kg
	Unloaded Spreading drone weight (without battery)	40.7kg	46kg
	Max Take-off weight	70kg	95kg
	Wheelbase	2025mm	2272mm
	Expand Size	Spraying drone: 2435*2541*752mm Spreading drone:	Spraying drone: 2845*2718*830mm Spreading drone:

		2435*2541*774mm	2845*2718*890mm
	Folded size	Spraying drone: 979*684*752mm Spreading drone: 979*684*774mm	Spraying drone: 1066*677*830mm Spreading drone:1066*677*890mm
	No-load hovering time	17.5min (Test by14S 30000mah)	20min (Test by18S 30000mah)
	Full load hovering time	7.5min (Test by 14S 30000mah)	7min (Test by18S 30000mah)
	Working temperature	0-40℃	
Spraying system	Spaying tank	30L	50L (recommend 45L)
	Water Pump	Volt: 12-18S Power: 30W*2 Max flow: 8L/min*2	
	Nozzle	Volt: 12-18S Power: 500W*2 Atomized particle size: 50-500μm	
	Spray width	4-8m	
Spreading system	Spreading tank	50L	70L
	Max load	30kg	50kg
	Applicable granule	0.5-6mm dry solids	
	Spread width	8-12m	
Motor system	Model	11115	11122
	Volt	14S	18S
	KV	95kv	60kv
	Maximum power	7350W	9730W
	Continuous power	2600w	3100w
	Propeller size	43inch	48inch

Flight control	Operating Voltage	12-80V	
	Working temperature	-10~60℃	
	RTK	Level±0.1m, Vertical ±0.1m	
	GPS	Level±1.5m, Vertical±0.5m	
	Wind resistance level	Sustained wind: level 4, Gust: level 5	
Remote control	Resolution	1080*1920	
	display screen	5.5inch	
	Working time	12h	
	Charging time	5h (20W)	
	Control distance	3km (3mHeight without shelter)	
	Weight	850g	
Recommended battery	Volt	14S	18S
	Capacity	30000mah	30000mah

Note: The weight fluctuation is ±1kg according to the real operation and process.

Thanks for reading this manual, if you have any questions or suggestions, please feel free to contact us.