









# **CYLINDER** **PRODUCT GUIDE**



V5 & V10 cylinders

A range of 5-pin and 10-pin cylinders comprising of single, double & turn cylinders with euro & oval bodies. Keyed to differ, keyed alike or master keyed versions are also available.

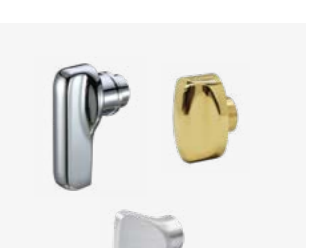
|   |  |  |   |
|---|--|--|---|
|  <p><b>V5EPS + V10EPS</b><br/>Euro single p428</p>                 |  <p><b>V5EPD + V10EPD</b><br/>Euro double p429</p>          |  <p><b>V5EPD + V10EPD</b><br/>Euro double offset p430</p>           |  <p><b>V5EPCT + V10EPCT</b><br/>Euro cylinder &amp; turn p432</p>        |
|  <p><b>V5EPCBL</b><br/>Euro turn &amp; coin release p433</p>       |  <p><b>V5EPST</b><br/>Euro single turn p433</p>             |  <p><b>V5EPTT</b><br/>Euro double turn p433</p>                     |  <p><b>V5EPCT + V10EPCT</b><br/>Euro offset cylinder &amp; turn p434</p> |
|  <p><b>V5EPCR + V10EPCR</b><br/>Euro classroom p437</p>          |  <p><b>V5RMC</b><br/>Rim cylinder p438</p>                |  <p><b>V5TRC</b><br/>Threaded rim cylinder p438</p>               |  <p><b>V10RMC</b><br/>Universal rim cylinder p438</p>                  |
|  <p><b>V5OPS + V10OPS</b><br/>Oval single p440</p>               |  <p><b>V5OPD + V10OPD</b><br/>Oval double p440</p>        |  <p><b>V5OPCT + V10OPCT</b><br/>Oval cylinder &amp; turn p440</p> |  <p><b>V5OPSOI + V5OPSO</b><br/>V5 Scandinavian oval p442</p>          |
|  <p><b>V10OPSOI + V10OPSO</b><br/>V10 Scandinavian oval p442</p> |  <p><b>V5-KA11</b><br/>Stock suite - keyed alike p443</p> |  <p><b>V10-KA31</b><br/>Stock suite - keyed alike p444</p>        |  <p><b>ACCESSORIES</b><br/>To suit EP &amp; OP cylinders p445</p>      |

# V5 CYLINDERS

V5 5-PIN CYLINDERS ARE AN ENTRY LEVEL SECURITY CYLINDER AND HAVE THE ABILITY TO BE KEYED TO CUSTOMERS' SPECIFIC REQUIREMENTS WITH KEYING OPTIONS: KEYED TO DIFFER (KTD), KEYED ALIKE (KA) AND UNDER MASTER KEY (UMK) CLASSROOM CYLINDERS.

V5 CYLINDERS ARE AVAILABLE IN A WIDE RANGE OF SIZES, STYLES AND FUNCTIONS IN POLISHED BRASS (PB), POLISHED CHROME (PC), SATIN CHROME (SC) AND POWDER COATED BLACK (BK) FINISHES. THESE CYLINDERS ARE SUITABLE FOR BOTH COMMERCIAL AND DOMESTIC USE.



- BS EN 1303 classifies the standard requirements and testing methods covering cylinders for locks
- Suitable for 30/60 minute fire doors
- Products suitable for commercial application
- Products suitable for domestic application
- Cylinders designed with an anti-drill feature
- Cylinders designed with an anti-pick feature
- Cylinders designed with a break-off system

## CYLINDER MEASUREMENTS

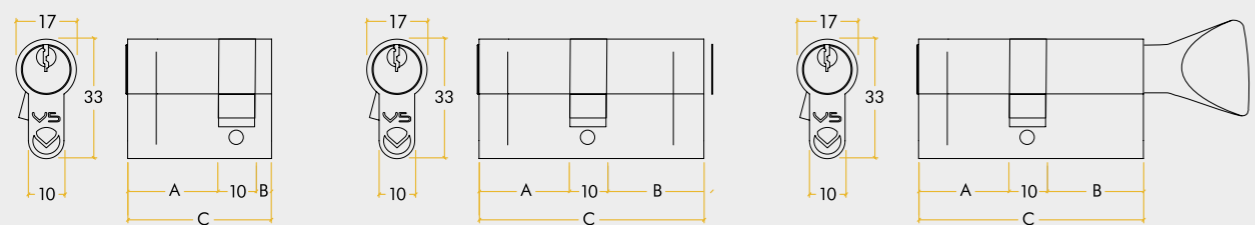

A = Barrel size  
B = 5mm  
C = Total length  
Barrel size starts from 25mm

A,B = Barrel size  
C = Total length  
Barrel size starts from 25mm

A,B = Barrel size  
C = Total length  
Barrel size starts from 25mm

# V10 CYLINDERS

V10 RESTRICTED 10-PIN CYLINDERS ARE CERTIFIED WITH BS EN 1303 CYLINDER SECURITY GRADE 2.

AVAILABLE IN A WIDE RANGE OF SIZES, STYLES AND FUNCTIONS, THESE CYLINDERS ARE SUITABLE FOR BOTH DOMESTIC AND COMMERCIAL APPLICATIONS.

THESE CYLINDERS CAN BE BUILT BESPOKE TO BUILDING REQUIREMENTS WITH KEYING OPTIONS KTD, KA AND UMK EURO PROFILE, OVAL PROFILE & RIM CYLINDERS AND ALSO CLASSROOM CYLINDERS.



- BS EN 1303 classifies the standard requirements and testing methods covering cylinders for locks
- Suitable for 30/60 minute fire doors
- Products suitable for commercial application
- Products suitable for domestic application
- Cylinders designed with an anti-drill feature
- Cylinders designed with an anti-pick feature

## CYLINDER MEASUREMENTS

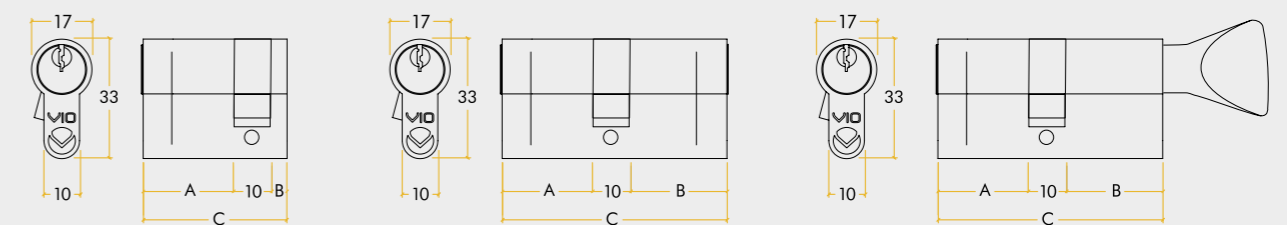

A = Barrel size  
B = 5mm  
C = Total length  
Barrel size starts from 25mm

A,B = Barrel size  
C = Total length  
Barrel size starts from 25mm

A,B = Barrel size  
C = Total length  
Barrel size starts from 25mm

### V5EP40S – 75S

V5 euro single cylinders



V5EP45SPB

#### KEY FEATURES

- BS EN 1303
- Anti-drill cylinder
- Anti-pick cylinder
- Break-off system
- Adjustable cam
- Available as:
  - Body only
  - Key to differ (E)
  - Keyed alike (KA)
  - Master keyed (MK)

#### STANDARDS



#### FINISHES



### V5EP60D – 100D

V5 euro double cylinders



V5EP80DBK

#### KEY FEATURES

- BS EN 1303
- Anti-drill cylinder
- Anti-pick cylinder
- Break-off system
- Available as:
  - Body only
  - Key to differ (E)
  - Keyed alike (KA)
  - Master keyed (MK)

#### STANDARDS



#### FINISHES



### V10EP42S – 55S

V10 restricted euro single cylinders



V10EP46SPC

#### KEY FEATURES

- BS EN 1303
- Anti-drill cylinder
- Anti-pick cylinder
- Adjustable cam
- Available as:
  - Body only
  - Key to differ (E)
  - Keyed alike (KA)
  - Master keyed (MK)
- Stamped for ease of re-ordering

#### STANDARDS



#### FINISHES



### V10EP64D – 100D

V10 restricted euro double cylinders



V10EP100DSC

#### KEY FEATURES

- BS EN 1303
- Anti-drill cylinder
- Anti-pick cylinder
- Available as:
  - Body only
  - Key to differ (E)
  - Keyed alike (KA)
  - Master keyed (MK)
- Stamped for ease of re-ordering

#### STANDARDS



#### FINISHES



| PRODUCT CODES | 5-PIN | 10-PIN RESTRICTED | A - MM | B - MM | C - MM | OFFSET | ADJUSTABLE CAM | ANTI-DRILL | ANTI-PICK | BREAK-OFF SYSTEM | FIREDOOR TESTED | AVAILABLE FINISHES |    |    |    |
|---------------|-------|-------------------|--------|--------|--------|--------|----------------|------------|-----------|------------------|-----------------|--------------------|----|----|----|
|               |       |                   |        |        |        |        |                |            |           |                  |                 | PB                 | PC | SC | BK |
| V5EP40S       | •     |                   | 25     | 5      | 40     |        | •              | •          | •         | •                | •               | •                  | •  | •  | •  |
| V5EP45S       | •     |                   | 30     | 5      | 45     |        | •              | •          | •         | •                | •               | •                  | •  | •  | •  |
| V5EP50S       | •     |                   | 35     | 5      | 50     |        | •              | •          | •         | •                | •               | •                  | •  | •  | •  |
| V5EP55S       | •     |                   | 40     | 5      | 55     |        | •              | •          | •         | •                | •               | •                  | •  | •  | •  |
| V5EP60S       | •     |                   | 45     | 5      | 60     |        | •              | •          | •         | •                | •               | •                  | •  | •  | •  |
| V5EP65S       | •     |                   | 50     | 5      | 65     |        | •              | •          | •         | •                | •               | •                  | •  | •  | •  |
| V5EP70S       | •     |                   | 55     | 5      | 70     |        | •              | •          | •         | •                | •               | •                  | •  | •  | •  |
| V5EP75S       | •     |                   | 60     | 5      | 75     |        | •              | •          | •         | •                | •               | •                  | •  | •  | •  |
| V10EP42S      |       | •                 | 27     | 5      | 42     |        | •              | •          | •         | •                | •               | •                  | •  | •  | •  |
| V10EP46S      |       | •                 | 31     | 5      | 46     |        | •              | •          | •         | •                | •               | •                  | •  | •  | •  |
| V10EP50S      |       | •                 | 35     | 5      | 50     |        | •              | •          | •         | •                | •               | •                  | •  | •  | •  |
| V10EP55S      |       | •                 | 40     | 5      | 55     |        | •              | •          | •         | •                | •               | •                  | •  | •  | •  |

#### TECHNICAL

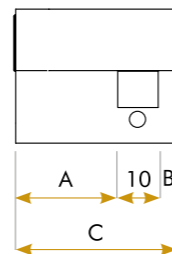

A = Barrel size  
B = 5mm  
C = Total length  
Barrel size starts from 25mm

| PRODUCT CODES | 5-PIN | 10-PIN RESTRICTED | A - MM | B - MM | C - MM | OFFSET | ADJUSTABLE CAM | ANTI-DRILL | ANTI-PICK | BREAK-OFF SYSTEM | FIREDOOR TESTED | AVAILABLE FINISHES |    |    |    |
|---------------|-------|-------------------|--------|--------|--------|--------|----------------|------------|-----------|------------------|-----------------|--------------------|----|----|----|
|               |       |                   |        |        |        |        |                |            |           |                  |                 | PB                 | PC | SC | BK |
| V5EP60D       | •     |                   | 25     | 25     | 60     |        |                | •          | •         | •                | •               | •                  | •  | •  | •  |
| V5EP70D       | •     |                   | 30     | 30     | 70     |        |                | •          | •         | •                | •               | •                  | •  | •  | •  |
| V5EP80D       | •     |                   | 35     | 35     | 80     |        |                | •          | •         | •                | •               | •                  | •  | •  | •  |
| V5EP90D       | •     |                   | 40     | 40     | 90     |        |                | •          | •         | •                | •               | •                  | •  | •  | •  |
| V5EP100D      | •     |                   | 45     | 45     | 100    |        |                | •          | •         | •                | •               | •                  | •  | •  | •  |
| V10EP64D      |       | •                 | 27     | 27     | 64     |        |                | •          | •         | •                | •               | •                  | •  | •  | •  |
| V10EP70D      |       | •                 | 30     | 30     | 70     |        |                | •          | •         | •                | •               | •                  | •  | •  | •  |
| V10EP80D      |       | •                 | 35     | 35     | 80     |        |                | •          | •         | •                | •               | •                  | •  | •  | •  |
| V10EP90D      |       | •                 | 40     | 40     | 90     |        |                | •          | •         | •                | •               | •                  | •  | •  | •  |
| V10EP100D     |       | •                 | 45     | 45     | 100    |        |                | •          | •         | •                | •               | •                  | •  | •  | •  |

#### TECHNICAL

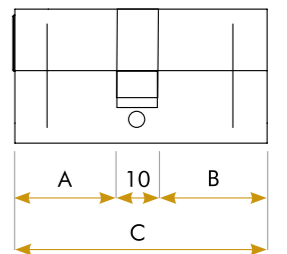

A, B = Barrel Size  
C = Total Length  
Barrel size starts from 25mm



V5EP3545DPB



V5EP3555DSC

### V5EP3040D - 4555D

V5 euro double offset cylinders

#### KEY FEATURES

- BS EN 1303
- Anti-drill cylinder
- Anti-pick cylinder
- Break-off system
- Available as:
  - Body only
  - Key to differ (E)
  - Keyed alike (KA)
  - Master keyed (MK)

#### STANDARDS



#### FINISHES

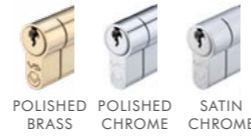

### V10EP42S - 55S

V10 restricted euro single cylinders

#### KEY FEATURES

- BS EN 1303
- Anti-drill cylinder
- Anti-pick cylinder
- Adjustable cam
- Available as:
  - Body only
  - Key to differ (E)
  - Keyed alike (KA)
  - Master keyed (MK)
- Stamped for ease of re-ordering

#### STANDARDS



#### FINISHES

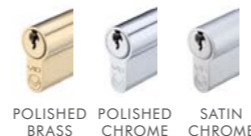

V10EP3240DPC



V10EP3240DPB

| PRODUCT CODES | 5-PIN | 10-PIN RESTRICTED | A - MM | B - MM | C - MM | OFFSET | ADJUSTABLE CAM | ANTI-DRILL | ANTI-PICK | BREAK-OFF SYSTEM | FIRE DOOR TESTED | AVAILABLE FINISHES |    |    |    |
|---------------|-------|-------------------|--------|--------|--------|--------|----------------|------------|-----------|------------------|------------------|--------------------|----|----|----|
|               |       |                   |        |        |        |        |                |            |           |                  |                  | PB                 | PC | SC | BK |
| V5EP3040D     | •     |                   | 25     | 35     | 70     | •      |                | •          | •         | •                | •                | •                  | •  | •  |    |
| V5EP3050D     | •     |                   | 25     | 45     | 80     | •      |                | •          | •         | •                | •                | •                  | •  | •  |    |
| V5EP3070D     | •     |                   | 25     | 65     | 100    | •      |                | •          | •         | •                | •                | •                  | •  | •  |    |
| V5EP3540D     | •     |                   | 30     | 35     | 75     | •      |                | •          | •         | •                | •                | •                  | •  | •  |    |
| V5EP3545D     | •     |                   | 30     | 40     | 80     | •      |                | •          | •         | •                | •                | •                  | •  | •  |    |
| V5EP3550D     | •     |                   | 30     | 45     | 85     | •      |                | •          | •         | •                | •                | •                  | •  | •  |    |
| V5EP3555D     | •     |                   | 30     | 50     | 90     | •      |                | •          | •         | •                | •                | •                  | •  | •  |    |
| V5EP4045D     | •     |                   | 35     | 40     | 85     | •      |                | •          | •         | •                | •                | •                  | •  | •  |    |
| V5EP4050D     | •     |                   | 35     | 45     | 90     | •      |                | •          | •         | •                | •                | •                  | •  | •  |    |
| V5EP4055D     | •     |                   | 35     | 50     | 95     | •      |                | •          | •         | •                | •                | •                  | •  | •  |    |
| V5EP4060D     | •     |                   | 35     | 55     | 100    | •      |                | •          | •         | •                | •                | •                  | •  | •  |    |
| V5EP4550D     | •     |                   | 40     | 45     | 95     | •      |                | •          | •         | •                | •                | •                  | •  | •  |    |
| V5EP4555D     | •     |                   | 40     | 50     | 100    | •      |                | •          | •         | •                | •                | •                  | •  | •  |    |
| V10EP3240D    |       | •                 | 27     | 35     | 72     | •      |                | •          | •         |                  | •                | •                  | •  | •  |    |
| V10EP3250D    |       | •                 | 27     | 45     | 82     | •      |                | •          | •         |                  | •                | •                  | •  | •  |    |
| V10EP3270D    |       | •                 | 27     | 65     | 102    | •      |                | •          | •         |                  | •                | •                  | •  | •  |    |
| V10EP3540D    |       | •                 | 30     | 35     | 75     | •      |                | •          | •         |                  | •                | •                  | •  | •  |    |
| V10EP3545D    |       | •                 | 30     | 40     | 80     | •      |                | •          | •         |                  | •                | •                  | •  | •  |    |
| V10EP3550D    |       | •                 | 30     | 45     | 85     | •      |                | •          | •         |                  | •                | •                  | •  | •  |    |
| V10EP3555D    |       | •                 | 30     | 50     | 90     | •      |                | •          | •         |                  | •                | •                  | •  | •  |    |
| V10EP4045D    |       | •                 | 35     | 40     | 85     | •      |                | •          | •         |                  | •                | •                  | •  | •  |    |
| V10EP4050D    |       | •                 | 35     | 45     | 90     | •      |                | •          | •         |                  | •                | •                  | •  | •  |    |
| V10EP4055D    |       | •                 | 35     | 50     | 95     | •      |                | •          | •         |                  | •                | •                  | •  | •  |    |
| V10EP4060D    |       | •                 | 35     | 55     | 100    | •      |                | •          | •         |                  | •                | •                  | •  | •  |    |
| V10EP4550D    |       | •                 | 40     | 45     | 95     | •      |                | •          | •         |                  | •                | •                  | •  | •  |    |
| V10EP4555D    |       | •                 | 40     | 50     | 100    | •      |                | •          | •         |                  | •                | •                  | •  | •  |    |

#### TECHNICAL

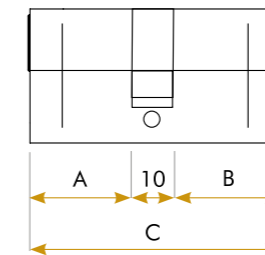

A, B = Barrel Size  
C = Total Length

Barrel size starts from 30mm



V5EP70CTBK

### V5EP60CT – 100CT

V5 euro cylinder & turn

#### KEY FEATURES

- BS EN 1303
- Anti-drill cylinder
- Anti-pick cylinder
- Break-off system
- Available as:
  - Body only
  - Key to differ (E)
  - Keyed alike (KA)
  - Master keyed (MK)

#### STANDARDS



#### FINISHES



V10EP70CTSC

### V10EP64CT – 100CT

V10 restricted euro cylinder & turn

#### KEY FEATURES

- BS EN 1303
- Anti-drill cylinder
- Anti-pick cylinder
- Available as:
  - Body only
  - Key to differ (E)
  - Keyed alike (KA)
  - Master keyed (MK)
- Stamped for ease of re-ordering

#### STANDARDS



#### FINISHES



V5EP70CBLSC

### V5EP70CBL

V5 euro turn & coin release bathroom cylinder

#### KEY FEATURES

- 70mm cylinder
- Anti-drill cylinder
- Anti-pick cylinder
- Break-off system
- Available as:
  - Body only
  - Key to differ (E)
  - Keyed alike (KA)
  - Master keyed (MK)

#### STANDARDS



#### FINISHES



V5EP40STPB

V5EP70TTSC

### V5EP40ST – 55ST

V5 euro single – turn only

### V5EP60TT – 80TT

V5 euro double turn cylinders

#### KEY FEATURES

- Single – turn only
- Double – double turn

#### STANDARDS



#### FINISHES



| PRODUCT CODES | 5-PIN | 10-PIN RESTRICTED | A – MM | B – MM | C – MM | OFFSET | ADJUSTABLE CAM | ANTI-DRILL | ANTI-PICK | BREAK-OFF SYSTEM | FIRE DOOR TESTED | AVAILABLE FINISHES |    |    |    |
|---------------|-------|-------------------|--------|--------|--------|--------|----------------|------------|-----------|------------------|------------------|--------------------|----|----|----|
|               |       |                   |        |        |        |        |                |            |           |                  |                  | PB                 | PC | SC | BK |
| V5EP60CT      | •     |                   | 25     | 25     | 60     |        |                | •          | •         | •                | •                | •                  | •  | •  | •  |
| V5EP70CT      | •     |                   | 30     | 30     | 70     |        |                | •          | •         | •                | •                | •                  | •  | •  | •  |
| V5EP80CT      | •     |                   | 35     | 35     | 80     |        |                | •          | •         | •                | •                | •                  | •  | •  | •  |
| V5EP90CT      | •     |                   | 40     | 40     | 90     |        |                | •          | •         | •                | •                | •                  | •  | •  | •  |
| V5EP100CT     | •     |                   | 45     | 45     | 100    |        |                | •          | •         | •                | •                | •                  | •  | •  | •  |
| V10EP64CT     |       | •                 | 27     | 27     | 64     |        |                | •          | •         | •                | •                | •                  | •  | •  | •  |
| V10EP70CT     |       | •                 | 30     | 30     | 70     |        |                | •          | •         | •                | •                | •                  | •  | •  | •  |
| V10EP80CT     |       | •                 | 35     | 35     | 80     |        |                | •          | •         | •                | •                | •                  | •  | •  | •  |
| V10EP90CT     |       | •                 | 40     | 40     | 90     |        |                | •          | •         | •                | •                | •                  | •  | •  | •  |
| V10EP100CT    |       | •                 | 45     | 45     | 100    |        |                | •          | •         | •                | •                | •                  | •  | •  | •  |

#### TECHNICAL

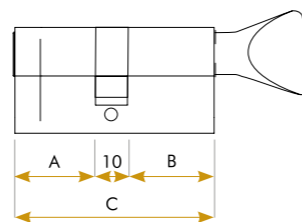

A, B = Barrel Size  
C = Total Length  
Barrel size starts from 25mm

| PRODUCT CODES | 5-PIN | 10-PIN RESTRICTED | A – MM | B – MM | C – MM | OFFSET | ADJUSTABLE CAM | ANTI-DRILL | ANTI-PICK | BREAK-OFF SYSTEM | FIRE DOOR TESTED | AVAILABLE FINISHES |    |    |    |
|---------------|-------|-------------------|--------|--------|--------|--------|----------------|------------|-----------|------------------|------------------|--------------------|----|----|----|
|               |       |                   |        |        |        |        |                |            |           |                  |                  | PB                 | PC | SC | BK |
| V5EP70CBL     | •     |                   | 25     | 25     | 60     |        |                | •          | •         | •                | •                | •                  | •  | •  | •  |
| V5EP40ST      | •     |                   | 25     | 5      | 40     |        |                |            |           |                  |                  | •                  | •  | •  | •  |
| V5EP45ST      | •     |                   | 30     | 5      | 45     |        |                |            |           |                  |                  | •                  | •  | •  | •  |
| V5EP50ST      | •     |                   | 35     | 5      | 50     |        |                |            |           |                  |                  | •                  | •  | •  | •  |
| V5EP55ST      | •     |                   | 40     | 5      | 55     |        |                |            |           |                  |                  | •                  | •  | •  | •  |
| V5EP60TT      | •     |                   | 25     | 25     | 60     |        |                |            |           |                  |                  | •                  | •  | •  | •  |
| V5EP70TT      | •     |                   | 30     | 30     | 70     |        |                |            |           |                  |                  | •                  | •  | •  | •  |
| V5EP80TT      | •     |                   | 35     | 35     | 80     |        |                |            |           |                  |                  | •                  | •  | •  | •  |

#### TECHNICAL

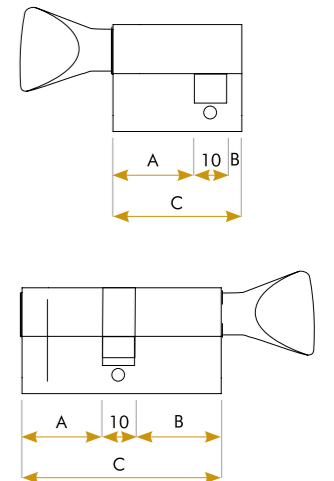



V5EP4535CTPC

### V5EP3545CT – 6040CT

V5 euro offset cylinder & turns

#### KEY FEATURES

- BS EN 1303
- Anti-drill cylinder
- Anti-pick cylinder
- Break-off system
- Available as:
  - Body only
  - Key to differ (E)
  - Keyed alike (KA)
  - Master keyed (MK)

#### STANDARDS



#### FINISHES



| PRODUCT CODES | 5-PIN | 10-PIN RESTRICTED | A - MM | B - MM | C - MM | OFFSET | ADJUSTABLE CAM | ANTI-DRILL | ANTI-PICK | BREAK-OFF SYSTEM | FIRE DOOR TESTED | AVAILABLE FINISHES |    |    |    |
|---------------|-------|-------------------|--------|--------|--------|--------|----------------|------------|-----------|------------------|------------------|--------------------|----|----|----|
|               |       |                   |        |        |        |        |                |            |           |                  |                  | PB                 | PC | SC | BK |
| V5EP3040CT    | •     |                   | 25     | 35     | 70     | •      |                | •          | •         |                  | •                | •                  | •  | •  |    |
| V5EP3050CT    | •     |                   | 25     | 45     | 80     | •      |                | •          | •         |                  | •                | •                  | •  | •  |    |
| V5EP3070CT    | •     |                   | 25     | 65     | 100    | •      |                | •          | •         |                  | •                | •                  | •  | •  |    |
| V5EP3540CT    | •     |                   | 30     | 35     | 75     | •      |                | •          | •         |                  | •                | •                  | •  | •  |    |
| V5EP3545CT    | •     |                   | 30     | 40     | 80     | •      |                | •          | •         |                  | •                | •                  | •  | •  |    |
| V5EP3555CT    | •     |                   | 30     | 50     | 90     | •      |                | •          | •         |                  | •                | •                  | •  | •  |    |
| V5EP4030CT    | •     |                   | 35     | 25     | 70     | •      |                | •          | •         |                  | •                | •                  | •  | •  |    |
| V5EP4035CT    | •     |                   | 35     | 30     | 75     | •      |                | •          | •         |                  | •                | •                  | •  | •  |    |
| V5EP4045CT    | •     |                   | 35     | 40     | 85     | •      |                | •          | •         |                  | •                | •                  | •  | •  |    |
| V5EP4050CT    | •     |                   | 35     | 45     | 90     | •      |                | •          | •         |                  | •                | •                  | •  | •  |    |
| V5EP4060CT    | •     |                   | 35     | 55     | 100    | •      |                | •          | •         |                  | •                | •                  | •  | •  |    |
| V5EP4535CT    | •     |                   | 40     | 30     | 80     | •      |                | •          | •         |                  | •                | •                  | •  | •  |    |
| V5EP4540CT    | •     |                   | 40     | 35     | 85     | •      |                | •          | •         |                  | •                | •                  | •  | •  |    |
| V5EP4555CT    | •     |                   | 40     | 50     | 100    | •      |                | •          | •         |                  | •                | •                  | •  | •  |    |
| V5EP5030CT    | •     |                   | 45     | 25     | 80     | •      |                | •          | •         |                  | •                | •                  | •  | •  |    |
| V5EP5040CT    | •     |                   | 45     | 35     | 90     | •      |                | •          | •         |                  | •                | •                  | •  | •  |    |
| V5EP5545CT    | •     |                   | 50     | 40     | 100    | •      |                | •          | •         |                  | •                | •                  | •  | •  |    |
| V5EP6040CT    | •     |                   | 55     | 35     | 100    | •      |                | •          | •         |                  | •                | •                  | •  | •  |    |
| V5EP7030CT    | •     |                   | 65     | 25     | 100    | •      |                | •          | •         |                  | •                | •                  | •  | •  |    |
| V10EP3240CT   |       | •                 | 27     | 35     | 72     | •      |                | •          | •         |                  | •                | •                  | •  | •  |    |
| V10EP3545CT   |       | •                 | 30     | 40     | 80     | •      |                | •          | •         |                  | •                | •                  | •  | •  |    |
| V10EP4032CT   |       | •                 | 35     | 27     | 72     | •      |                | •          | •         |                  | •                | •                  | •  | •  |    |
| V10EP4050CT   |       | •                 | 35     | 45     | 90     | •      |                | •          | •         |                  | •                | •                  | •  | •  |    |
| V10EP4060CT   |       | •                 | 35     | 55     | 100    | •      |                | •          | •         |                  | •                | •                  | •  | •  |    |
| V10EP4535CT   |       | •                 | 40     | 30     | 80     | •      |                | •          | •         |                  | •                | •                  | •  | •  |    |
| V10EP4550CT   |       | •                 | 40     | 45     | 95     | •      |                | •          | •         |                  | •                | •                  | •  | •  |    |
| V10EP4555CT   |       | •                 | 40     | 50     | 100    | •      |                | •          | •         |                  | •                | •                  | •  | •  |    |
| V10EP5040CT   |       | •                 | 45     | 35     | 90     | •      |                | •          | •         |                  | •                | •                  | •  | •  |    |
| V10EP5045CT   |       | •                 | 45     | 40     | 95     | •      |                | •          | •         |                  | •                | •                  | •  | •  |    |
| V10EP5545CT   |       | •                 | 50     | 40     | 100    | •      |                | •          | •         |                  | •                | •                  | •  | •  |    |
| V10EP6040CT   |       | •                 | 55     | 35     | 100    | •      |                | •          | •         |                  | •                | •                  | •  | •  |    |



V10EP5045CTPB

### V10EP3240CT – 6040CT

V10 restricted euro offset cylinder & turn

#### KEY FEATURES

- BS EN 1303
- Anti-drill cylinder
- Anti-pick cylinder
- Available as:
  - Body only
  - Key to differ (E)
  - Keyed alike (KA)
  - Master keyed (MK)
- Stamped for ease of re-ordering

#### STANDARDS



#### FINISHES



V10EP5045CTPC

#### TECHNICAL

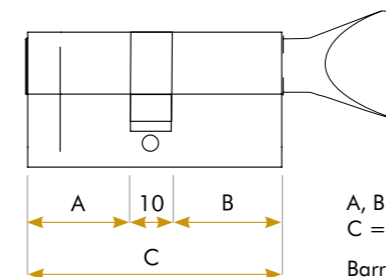

A, B = Barrel Size  
C = Total Length  
Barrel size starts from 30mm

## CLASSROOM CYLINDERS

THE CLASSROOM CYLINDER ALLOWS THE DOOR TO BE LOCKED AND UNLOCKED FROM THE OUTSIDE USING A KEY.

FROM THE INSIDE THE DOOR CAN ONLY BE UNLOCKED USING THE THUMB TURN, THE DOOR CANNOT BE LOCKED FROM THE INSIDE. THIS MIGHT BE USED IN A CLASSROOM TO AVOID A SITUATION WHERE CHILDREN HAVE LOCKED THE CLASSROOM FROM THE INSIDE, NECESSITATING A KEY HOLDER TO COME AND UNLOCK THE DOOR.

FOR SAFETY REASONS THE CYLINDER HAS A TURN ON THE INSIDE WHICH WILL ONLY UNLOCK THE DOOR IF AN OCCUPIER HAS BEEN ACCIDENTALLY LOCKED INSIDE.

## ANTI-BARRICADE CYLINDERS

IN SOME CIRCUMSTANCES SUCH AS SECURE INSTITUTIONS, CARE HOMES AND PSYCHIATRIC FACILITIES, IT IS DESIRABLE TO PREVENT THE INSIDE THUMB TURN ON THE CYLINDER BEING USED TO HOLD THE DEADBOLT IN THE LOCKED POSITION, PREVENTING ACCESS BY KEY FROM OUTSIDE.

THIS CLUTCH MECHANISM IS AVAILABLE WHICH ISOLATES THE THUMB TURN FROM THE KEYWAY SO THAT IN AN EMERGENCY THE KEY WILL OVERRIDE THE THUMB TURN IF IT IS BEING HELD.

GET IN TOUCH WITH OUR DEDICATED CYLINDERS TEAM TO DISCUSS YOUR BESPOKE REQUIREMENTS CALL: **01228 673501** OR EMAIL: **CYLINDERSALES@ZOO-HARDWARE.CO.UK**



V5EP70CRRSC (Right)

### V5EPCR70 – CR80

V5 euro classroom cylinder & turn

#### KEY FEATURES

- BS EN 1303
- Anti-drill cylinder
- Anti-pick cylinder
- Break-off system

#### STANDARDS



#### FINISHES



V10EP70CRRPB

### V10EP70CR – 80CR

V10 restricted euro classroom cylinder & turn

#### KEY FEATURES

- BS EN 1303
- Anti-drill cylinder
- Anti-pick cylinder
- Available as:
  - Body only
  - Key to differ (E)
  - Keyed alike (KA)
  - Master keyed (MK)
- Stamped for ease of re-ordering

#### STANDARDS



#### FINISHES



| PRODUCT CODES      | 5-PIN | 10-PIN RESTRICTED | A - MM | B - MM | C - MM | OFFSET | ADJUSTABLE CAM | ANTI-DRILL | ANTI-PICK | BREAK-OFF SYSTEM | FIRE DOOR TESTED | AVAILABLE FINISHES |    |    |
|--------------------|-------|-------------------|--------|--------|--------|--------|----------------|------------|-----------|------------------|------------------|--------------------|----|----|
|                    |       |                   |        |        |        |        |                |            |           |                  |                  | PB                 | PC | SC |
| V5EP70CR           | •     |                   | 30     | 30     | 70     |        |                | •          | •         | •                | •                | •                  | •  | •  |
| V5EP80CR           | •     |                   | 35     | 35     | 80     |        |                | •          | •         | •                | •                | •                  | •  | •  |
| V10EP70CRR (Right) |       | •                 | 30     | 30     | 70     |        |                | •          | •         |                  | •                | •                  | •  | •  |
| V10EP70CRL (Left)  |       | •                 | 30     | 30     | 70     |        |                | •          | •         |                  | •                | •                  | •  | •  |
| V10EP80CRR (Right) |       | •                 | 35     | 35     | 80     |        |                | •          | •         |                  | •                | •                  | •  | •  |
| V10EP80CRL (Left)  |       | •                 | 35     | 35     | 80     |        |                | •          | •         |                  | •                | •                  | •  | •  |

#### TECHNICAL

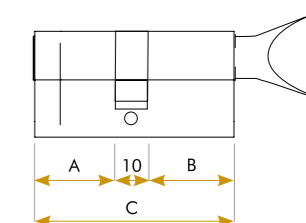

A, B = Barrel Size  
C = Total Length  
Barrel size starts from 25mm





V5RMC20PC

### V5RMC20 / V5TRC20

V5 rim & threaded rim cylinder bodies

#### KEY FEATURES

- BS EN 1303
- Anti-drill cylinder
- Anti-pick cylinder
- Available as:
  - Body only
  - Key to differ (E)
  - Keyed alike (KA)
  - Master keyed (MK)

#### STANDARDS



#### FINISHES



V10RMC20PB

### V10RMC20

V10 restricted universal rim cylinder

#### KEY FEATURES

- BS EN 1303
- Anti-drill cylinder
- Anti-pick cylinder
- Available as:
  - Body only
  - Key to differ (E)
  - Keyed alike (KA)
  - Master keyed (MK)

#### STANDARDS



#### FINISHES

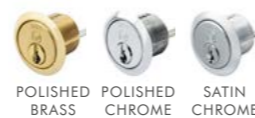

| PRODUCT CODES                  | 5-PIN | 10-PIN RESTRICTED | A - MM | B - MM | C - MM | OFFSET | ADJUSTABLE CAM | ANTI-DRILL | ANTI-PICK | BREAK-OFF SYSTEM | FIRE DOOR TESTED | AVAILABLE FINISHES |    |    |    |
|--------------------------------|-------|-------------------|--------|--------|--------|--------|----------------|------------|-----------|------------------|------------------|--------------------|----|----|----|
|                                |       |                   |        |        |        |        |                |            |           |                  |                  | PB                 | PC | SC | BK |
| V5RMC20<br>(Rim cylinder)      | •     |                   | 25     | 25     | 60     |        |                | •          | •         |                  | •                | •                  | •  | •  | •  |
| V5TRC20<br>(Threaded cylinder) | •     |                   | 25     | 5      | 40     |        |                | •          | •         |                  | •                | •                  | •  | •  |    |
| V10RMC20                       |       | •                 | 30     | 5      | 45     |        |                | •          | •         |                  | •                | •                  | •  | •  |    |

## CONSTRUCTION CYLINDERS

DURING THE CONSTRUCTION PROCESS IT IS NORMAL PRACTICE FOR THE CONTRACTORS TO HAVE CONTROL OF THE KEYS TO EACH CYLINDER BEING FITTED TO THE BUILDING. THIS COMPROMISES SECURITY AS KEYS CAN BECOME LOST OR STOLEN.

WITH CONSTRUCTION KEYING A SPECIAL PIN IS INCORPORATED INTO THE CYLINDER WHICH ALLOWS A SINGLE 'CONSTRUCTION KEY' TO BE ISSUED TO THE CONTRACTORS SO THEY CAN GAIN FULL ACCESS DURING THE CONSTRUCTION PERIOD. ONCE THE CONSTRUCTION PERIOD IS COMPLETED, THE CONSTRUCTION KEY IS RENDERED UNUSABLE ONCE THE MAIN KEY IS OPERATED.

**CONSTRUCTION CYLINDERS ARE ONLY AVAILABLE IN THE V10 CYLINDER.**

GET IN TOUCH WITH OUR DEDICATED CYLINDERS TEAM TO DISCUSS YOUR BESPOKE REQUIREMENTS CALL: **01228 673501** OR EMAIL: [CYLINDERSALES@ZOO-HARDWARE.CO.UK](mailto:CYLINDERSALES@ZOO-HARDWARE.CO.UK)

V5OP45SPB



**V5OP40S / 45S**

V5 oval single cylinders

**V5OP60D / 70D / 80D**

V5 oval double cylinders

V5OP60DSC



V5OP60CTSC

**V5OP60CT / 70CT / 80CT**

V5 oval cylinder & turns

**KEY FEATURES**

- Anti-drill cylinder

**STANDARDS**



**FINISHES**



V10OP42SSC



**V10OP42S / 46S**

V10 restricted oval single cylinders

**V10OP64D / 70D / 80D**

V10 restricted oval double cylinders

V10OP64DPB



V10OP70CTPC

**V10OP64CT / 70CT / 80CT**

V10 restricted oval cylinder & turns

**KEY FEATURES**

- Anti-drill cylinder
- Available as:
  - Body only
  - Key to differ (E)
  - Keyed alike (KA)
  - Master keyed (MK)
- Stamped for ease of re-ordering

**STANDARDS**



**FINISHES**

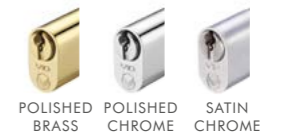

| PRODUCT CODES | 5-PIN | 10-PIN RESTRICTED | A - MM | B - MM | C - MM | OFFSET | ADJUSTABLE CAM | ANTI-DRILL | ANTI-PICK | BREAK-OFF SYSTEM | FIRE DOOR TESTED | AVAILABLE FINISHES |    |    |    |
|---------------|-------|-------------------|--------|--------|--------|--------|----------------|------------|-----------|------------------|------------------|--------------------|----|----|----|
|               |       |                   |        |        |        |        |                |            |           |                  |                  | PB                 | PC | SC | BK |
| V5OP40S       | •     |                   | 25     | 5      | 40     |        |                | •          |           |                  | •                | •                  | •  | •  |    |
| V5OP45S       | •     |                   | 30     | 5      | 45     |        |                | •          |           |                  | •                | •                  | •  | •  |    |
| V5OP60D       | •     |                   | 25     | 25     | 60     |        |                | •          |           |                  | •                | •                  | •  | •  |    |
| V5OP70D       | •     |                   | 30     | 30     | 70     |        |                | •          |           |                  | •                | •                  | •  | •  |    |
| V5OP80D       | •     |                   | 35     | 35     | 80     |        |                | •          |           |                  | •                | •                  | •  | •  |    |
| V5OP60CT      | •     |                   | 25     | 25     | 60     |        |                | •          |           |                  | •                | •                  | •  | •  |    |
| V5OP70CT      | •     |                   | 30     | 30     | 70     |        |                | •          |           |                  | •                | •                  | •  | •  |    |
| V5OP80CT      | •     |                   | 35     | 35     | 80     |        |                | •          |           |                  | •                | •                  | •  | •  |    |

**TECHNICAL**

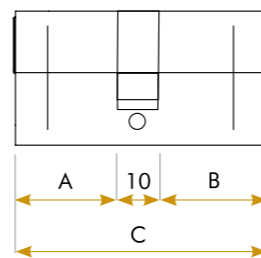
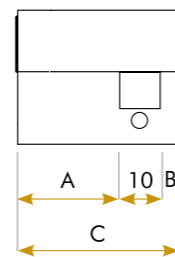

A, B = Barrel Size  
C = Total Length  
Barrel size starts from 25mm

| PRODUCT CODES | 5-PIN | 10-PIN RESTRICTED | A - MM | B - MM | C - MM | OFFSET | ADJUSTABLE CAM | ANTI-DRILL | ANTI-PICK | BREAK-OFF SYSTEM | FIRE DOOR TESTED | AVAILABLE FINISHES |    |    |    |
|---------------|-------|-------------------|--------|--------|--------|--------|----------------|------------|-----------|------------------|------------------|--------------------|----|----|----|
|               |       |                   |        |        |        |        |                |            |           |                  |                  | PB                 | PC | SC | BK |
| V10OP42S      |       | •                 | 27     | 5      | 42     |        |                | •          |           |                  | •                | •                  | •  | •  |    |
| V10OP46S      |       | •                 | 41     | 5      | 46     |        |                | •          |           |                  | •                | •                  | •  | •  |    |
| V10OP64D      |       | •                 | 27     | 27     | 64     |        |                | •          |           |                  | •                | •                  | •  | •  |    |
| V10OP70D      |       | •                 | 30     | 30     | 70     |        |                | •          |           |                  | •                | •                  | •  | •  |    |
| V10OP80D      |       | •                 | 35     | 35     | 80     |        |                | •          |           |                  | •                | •                  | •  | •  |    |
| V10OP64CT     |       | •                 | 27     | 27     | 64     |        |                | •          |           |                  | •                | •                  | •  | •  |    |
| V10OP70CT     |       | •                 | 30     | 30     | 70     |        |                | •          |           |                  | •                | •                  | •  | •  |    |
| V10OP80CT     |       | •                 | 35     | 35     | 80     |        |                | •          |           |                  | •                | •                  | •  | •  |    |

**TECHNICAL**

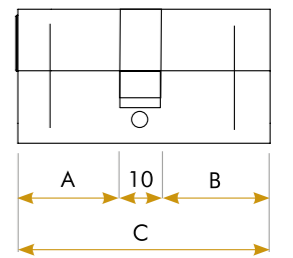
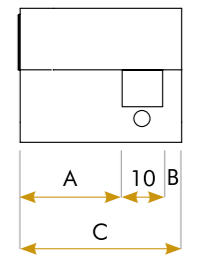

A, B = Barrel Size  
C = Total Length  
Barrel size starts from 25mm

### V5OPSOI-31

V5 Scandinavian oval cylinder (inner)



V5OPSOI-31SC



V5OPSOO-31PB

### V5OPSOO-31

V5 Scandinavian oval cylinder (outer)

#### KEY FEATURES

- Anti-drill cylinder
- Available as:
  - Body only
  - Key to differ (KTD)
  - Keyed alike (KA)
  - Master keyed (MK)

#### STANDARDS



#### FINISHES

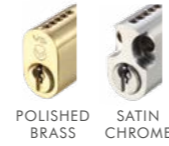

V5EP45SSCKA11

### V5 - KA11

V5 Stock suite - Keyed alike cylinders

#### KEY FEATURES

- BS EN 1303
- Anti-drill cylinder
- Anti-pick cylinder
- Break-off system\*

\* Does not apply to the V5RM or V5TC

#### STANDARDS



#### FINISHES



### V10OPSOI31

V10 restricted Scandinavian oval cylinder (inner)



V10OPSOI31PB



V10OPSO31SC

### V10OPSO31

V10 restricted Scandinavian oval cylinder (outer)

#### KEY FEATURES

- Anti-drill cylinder
- Available as:
  - Body only
  - Key to differ (KTD)
  - Keyed alike (KA)
  - Master keyed (MK)

#### STANDARDS



#### FINISHES

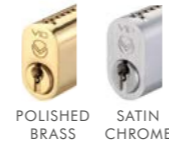

V5EP80DPBKA11



V5TRC20PCKA11

| PRODUCT CODES      | 5-PIN | 10-PIN RESTRICTED | A - MM | B - MM | C - MM | OFFSET | ADJUSTABLE CAM | ANTI-DRILL | ANTI-PICK | BREAK-OFF SYSTEM | FIRE DOOR TESTED | AVAILABLE FINISHES |    |    |    |
|--------------------|-------|-------------------|--------|--------|--------|--------|----------------|------------|-----------|------------------|------------------|--------------------|----|----|----|
|                    |       |                   |        |        |        |        |                |            |           |                  |                  | PB                 | PC | SC | BK |
| V5OPSOI-31 (Inner) | •     | -                 | -      | -      | 31     |        |                | •          |           |                  | •                | •                  |    | •  |    |
| V5OPSOO-31 (Outer) | •     | -                 | -      | -      | 31     |        |                | •          |           |                  | •                | •                  |    | •  |    |
| V10OPSOI31 (Inner) |       | •                 | -      | -      | 60     |        |                | •          |           |                  | •                | •                  |    | •  |    |
| V10OPSO31 (Outer)  |       | •                 | -      | -      | 40     |        |                | •          |           |                  | •                | •                  |    | •  |    |

#### TECHNICAL

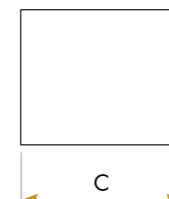

| PRODUCT CODES | 5-PIN | 10-PIN RESTRICTED | A - MM | B - MM | C - MM | OFFSET | ADJUSTABLE CAM | ANTI-DRILL | ANTI-PICK | BREAK-OFF SYSTEM | FIRE DOOR TESTED | AVAILABLE FINISHES |    |    |    |
|---------------|-------|-------------------|--------|--------|--------|--------|----------------|------------|-----------|------------------|------------------|--------------------|----|----|----|
|               |       |                   |        |        |        |        |                |            |           |                  |                  | PB                 | PC | SC | BK |
| V5EP40SKA11   | •     |                   | 25     | 5      | 40     |        |                | •          | •         | •                | •                |                    |    | •  |    |
| V5EP45SKA11   | •     |                   | 30     | 5      | 45     |        |                | •          | •         | •                | •                |                    |    | •  |    |
| V5EP60DKA11   | •     |                   | 25     | 25     | 60     |        |                | •          | •         | •                | •                |                    |    | •  |    |
| V5EP70DKA11   | •     |                   | 30     | 30     | 70     |        |                | •          | •         | •                | •                |                    |    | •  |    |
| V5EP80DKA11   | •     |                   | 35     | 35     | 80     |        |                | •          | •         | •                | •                |                    |    | •  |    |
| V5EP60CTKA11  | •     |                   | 27     | 27     | 64     |        |                | •          | •         | •                | •                |                    |    | •  |    |
| V5EP70CTKA11  | •     |                   | 30     | 30     | 70     |        |                | •          | •         | •                | •                |                    |    | •  |    |
| V5EP80CTKA11  | •     |                   | 35     | 35     | 80     |        |                | •          | •         | •                | •                |                    |    | •  |    |
| V5RMC20KA11   | •     |                   | -      | -      | 20     |        |                |            |           |                  | •                |                    |    | •  |    |
| V5TRC20KA11   | •     |                   | -      | -      | 20     |        |                |            |           |                  | •                |                    |    | •  |    |

#### TECHNICAL

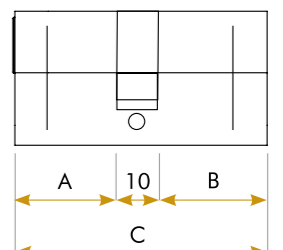
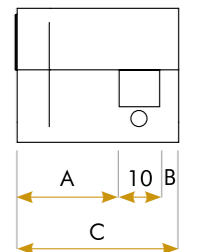

A, B = Barrel Size  
C = Total Length

Barrel size starts from 25mm



V10EP46SPCKA31

### V10EP - KA31

V10 restricted stock suite - Keyed alike cylinders

#### KEY FEATURES

- BS EN 1303
- Anti-drill cylinder
- Anti-pick cylinder

#### STANDARDS



#### FINISHES



V10EP80DSCKA31



V10RMC20PBKA31



DLTPC

### ACCESSORIES

To suit all EP and OP products

#### DLT

Disabled large turn to suit cylinder

#### PRODUCT CODES

- DLTPB
- DLTPC
- DLTSC



DTPB

#### DT

Designer turn to suit cylinder

#### PRODUCT CODES

- DTPB
- DTPC
- DTSC



STSC

#### ST

Standard turn to suit cylinder

#### PRODUCT CODES

- STPB
- STPC
- STSC

#### FINISHES



| PRODUCT CODES | 5-PIN | 10-PIN RESTRICTED | A - MM | B - MM | C - MM | OFFSET | ADJUSTABLE CAM | ANTI-DRILL | ANTI-PICK | BREAK-OFF SYSTEM | FIRE DOOR TESTED | AVAILABLE FINISHES |    |    |    |
|---------------|-------|-------------------|--------|--------|--------|--------|----------------|------------|-----------|------------------|------------------|--------------------|----|----|----|
|               |       |                   |        |        |        |        |                |            |           |                  |                  | PB                 | PC | SC | BK |
| V10EP42SKA31  |       | •                 | 27     | 5      | 42     |        |                | •          | •         |                  | •                | •                  | •  | •  |    |
| V10EP46SKA31  |       | •                 | 31     | 5      | 46     |        |                | •          | •         |                  | •                | •                  | •  | •  |    |
| V10EP64DKA31  |       | •                 | 27     | 27     | 64     |        |                | •          | •         |                  | •                | •                  | •  | •  |    |
| V10EP70DKA31  |       | •                 | 30     | 30     | 70     |        |                | •          | •         |                  | •                | •                  | •  | •  |    |
| V10EP80DKA31  |       | •                 | 35     | 35     | 80     |        |                | •          | •         |                  | •                | •                  | •  | •  |    |
| V10EP64CTKA31 |       | •                 | 27     | 27     | 64     |        |                | •          | •         |                  | •                | •                  | •  | •  |    |
| V10EP70CTKA31 |       | •                 | 30     | 30     | 70     |        |                | •          | •         |                  | •                | •                  | •  | •  |    |
| V10EP80CTKA31 |       | •                 | 35     | 35     | 80     |        |                | •          | •         |                  | •                | •                  | •  | •  |    |
| V10RMC20KA31  |       | •                 | -      | -      | 20     |        |                | •          | •         |                  | •                | •                  | •  | •  |    |

#### TECHNICAL

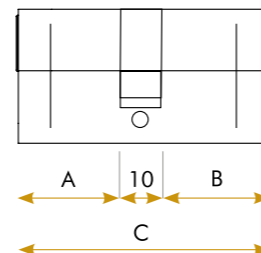
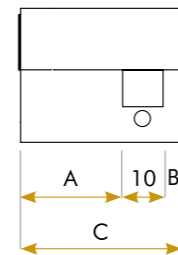

A, B = Barrel Size  
C = Total Length

Barrel size starts from 25mm



V5DK

## ACCESSORIES

To suit all V5EP and V5OP products

### V5MK

Master key & sub master key

#### PRODUCT CODES

- V5MK – (To suit bespoke MK suite)
- V5MK1 – (To suit MK1 stock suite – master key only)
- V5MK2 – (To suit MK2 stock suite – master key only)

### V5DK

Differ key

#### PRODUCT CODES

- V5DK



V5KB

### V5KB

5 pin square key blanks

#### PRODUCT CODES

- V5KB

### V51700

Cylinder retaining screws

#### PRODUCT CODES

- V51700EB – 64mm
- V51700NP – 64mm



V5KR

### V5KR

Key rings (per 100 No.)

#### PRODUCT CODES

- V5KR

**Always obtain official Vier keys that are cut from code. Please do not use 3rd party copy keys or traced keys.**

Zoo Hardware Ltd record the cutting depths and details of all keys when produced in our cylinder centre. This secure data base works with our key cutting machines to accurately cut keys to code.

A key that is not in tolerance with the correct cut depths & spaces can create issues in operation and in some instances render the cylinder inoperable. A correctly cut key that is cut to code will prevent this.



Contact our sales team for further details

**ERA** TS007:2014+A2:2018 BS EN 1303:2015  
**High Security 3 Star Euro Profile Cylinder**  
 SECURITY LOCKED WITHIN.

## FEATURES

- The cleverly designed central cam, will only rotate with the use of the correct key. So stays locked until you choose to unlock the door
- Fitted with a sacrificial snap line, the external half of the cylinder will snap at a designated point when under attack, protecting the central cam from any unwanted access, but still allows anyone with the correct key to operate the cylinder internally
- Independently tested and certified in accordance with British Kitemark TS007:2014+A2:2018 3 Star accreditation (TS007 3\*) and to BS EN 1303:2015
- 6-pin high security cylinder with anti-pick and anti-bump security pins; and anti-drill rods
- For ease of installation, the orientation is clearly marked on the cylinder, internal (INT) and external (EXT) and on an easy peel sticker
- Available in Satin Chrome, Polished Chrome or Satin Brass finishes, suitable for use with door handles with a Euro profile design
- Choice of single, double or thumbturn designs. Paired keyed alike cylinders for front and back door applications available
- Supplied with three strong nickel keys. Keys are uniquely coded to allow for ease of re-ordering replacement or additional keys
- BSI-approved re-pinning at ZOO - keyed alike, master key or supplied key to differ as standard.

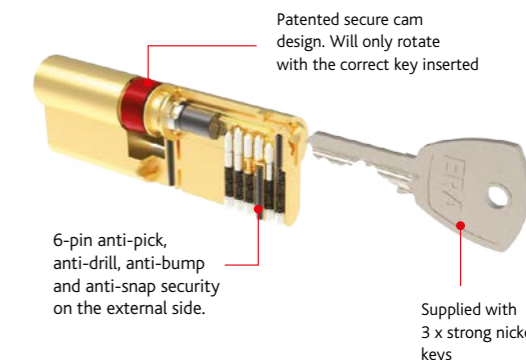

| Classification  |   |
|---|---|
| The ERA 3 Star high security cylinder carries the British Standard 3* Kitemark TS007:2014+A2:2018 and BS EN 1303:2015 accreditations. |   |
| <b>Classification:</b>  |   |
| Category Of Use   | 1 |
| Durability  | 6 |
| Door Mass   | 0 |
| Suitability of Fire resistant / Smoke Control Doors   | 1 |
| Safety  | 0 |
| Corrosion   | C |
| Key Related Security  | 6 |
| Attack Resistance   | D |



**Security Coded Key**  
6-Pin anti-pick, anti-drill, anti-bump and anti-snap security.



**Certified British Standard 3\* Kitemark**  
TS007:2014+A2:2018 and BS EN 1303:2015



**Patented Cam Design**  
Will only rotate with the correct key.



**10 YEAR**  
Mechanical Guarantee



**5 YEAR**  
Anti-Snap Guarantee



Timber Composite PVCu Aluminium



# BESPOKE CYLINDER KEYING SERVICE

MASTER KEY SYSTEMS CAN BE BUILT BESPOKE AS PER BUILDING REQUIREMENTS FROM EXCEL FILES, FLOOR PLANS OR SITE SURVEYS



GET IN TOUCH WITH OUR DEDICATED CYLINDERS TEAM TO DISCUSS YOUR BESPOKE REQUIREMENTS CALL: **01228 673501** OR EMAIL: **CYLINDERSALES@ZOO-HARDWARE.CO.UK**

OUR BESPOKE CYLINDER KEYING SERVICE OFFERS THE FOLLOWING KEYING SYSTEMS TO SUIT YOUR REQUIREMENTS:

## KEYED TO DIFFER

EACH LOCK IS OPENED BY ITS OWN UNIQUE KEY, WHICH DOES NOT OPEN ANY OTHER LOCK.

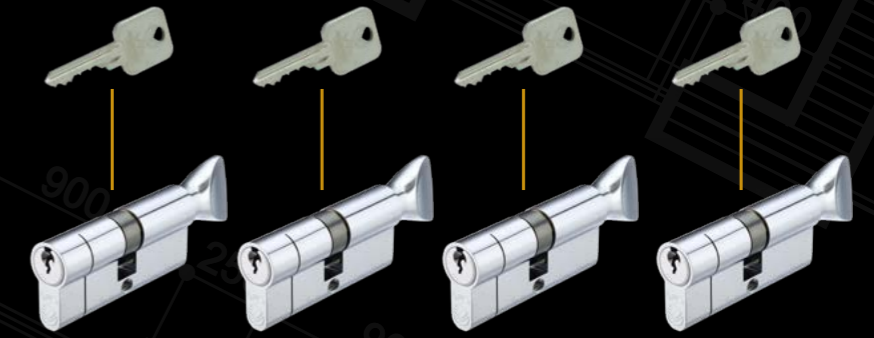

## KEYED ALIKE

ALL CYLINDERS IN THE SET ARE OPENED BY THE SAME KEY, THIS OPTION PROVIDES SAME KEY CONVENIENCE AND ELIMINATES THE NEED FOR MULTIPLE KEYS WHERE NUMEROUS CYLINDERS ARE USED.

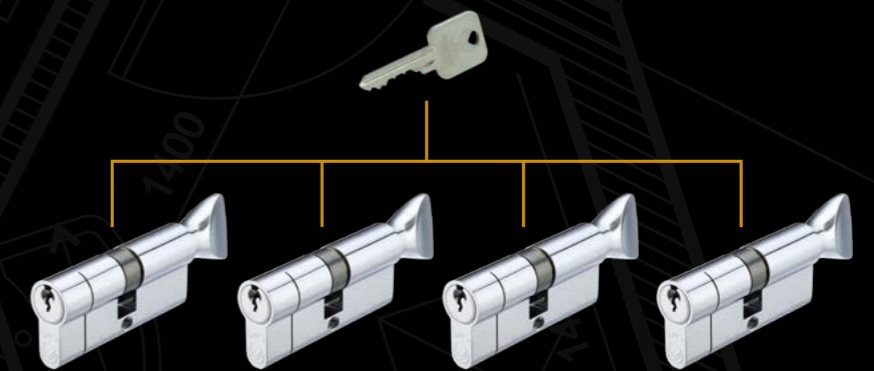

## UNDER MASTER KEY

WHERE ALL CYLINDER LOCKS ARE OPENED BY A SINGLE MASTER KEY THEN EACH OF THE CYLINDER LOCKS ARE OPENED BY THEIR OWN KEY, OFTEN REFERRED TO AS THE SLAVE, CHANGE OR DIFFER KEYS.

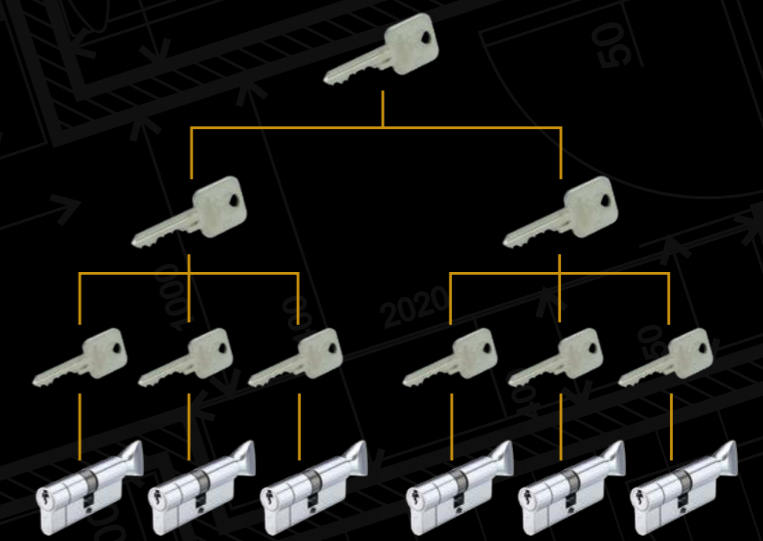

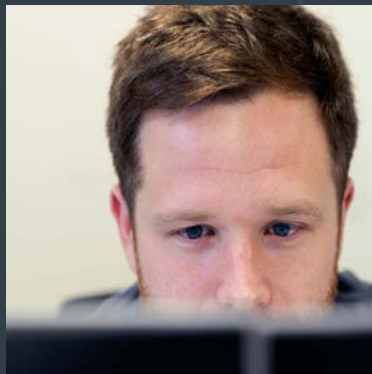

ZOO Hardware,  
Unit B, Dukes Drive,  
Kingmoor Park North,  
Carlisle, Cumbria,  
CA6 4SH.

**T** : +44 (0) 1228 673 501  
**M** : +44 (0) 7843 352 228  
**E** : [dan.johnson@zoo-hardware.co.uk](mailto:dan.johnson@zoo-hardware.co.uk)  
**W** : [www.zoohardware.co.uk](http://www.zoohardware.co.uk)