



# THE SIDEWINDER

BLOCK ROLLER COASTER



Instruction Manual

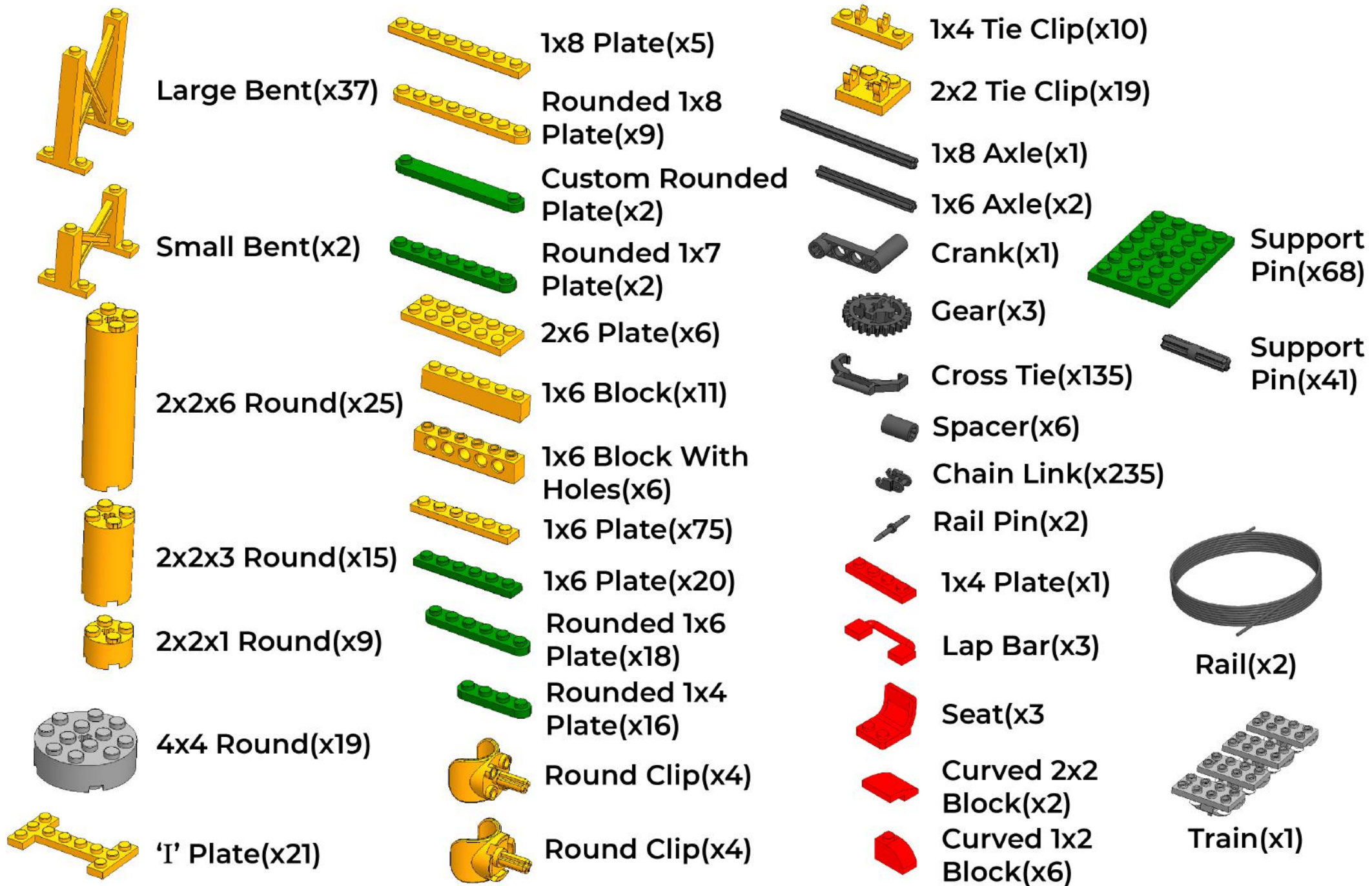

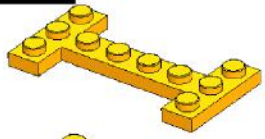

x15

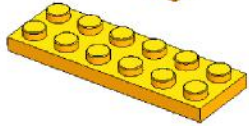

x2

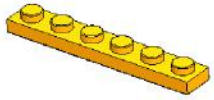

x18

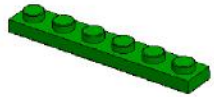

x2

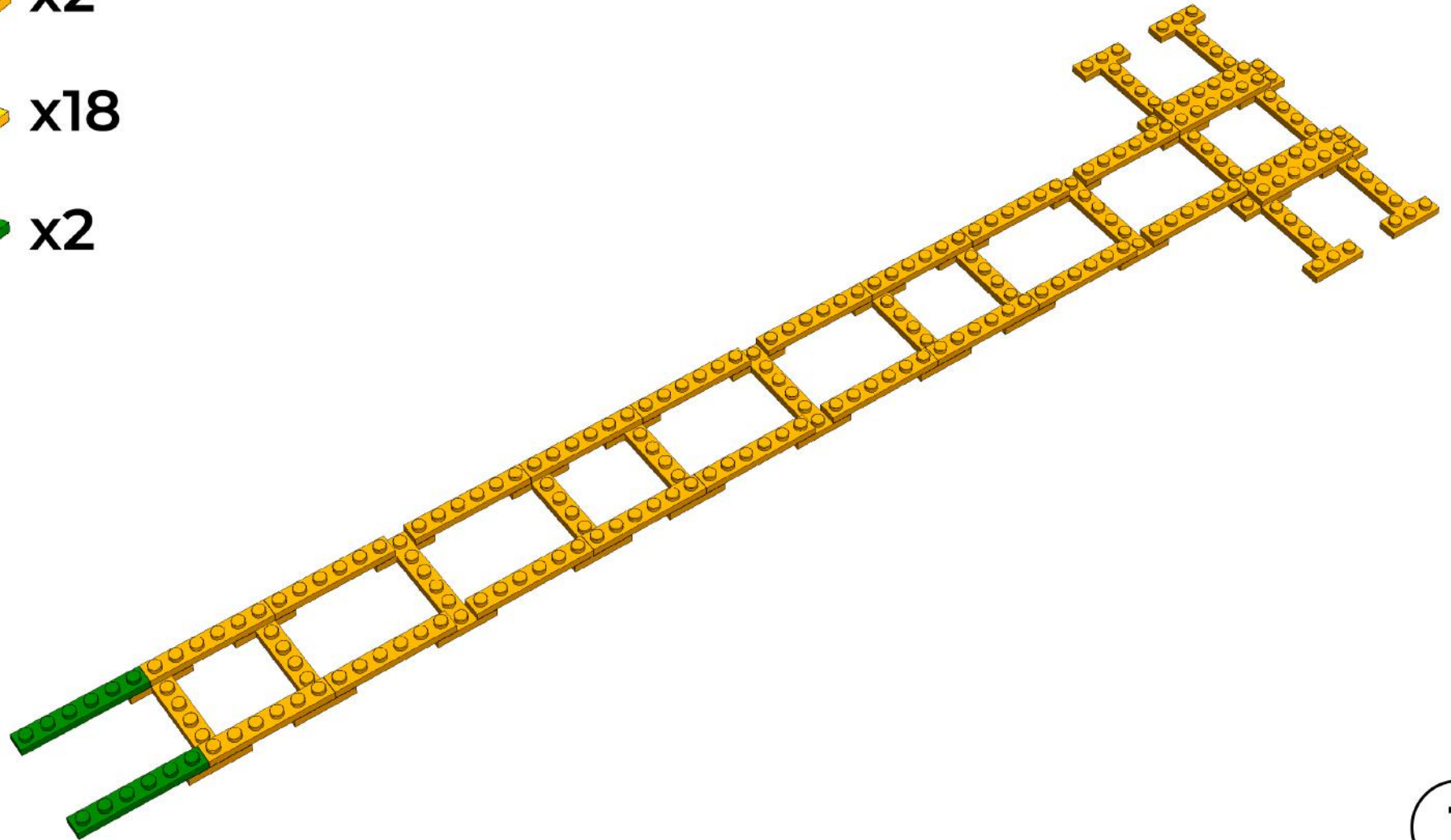

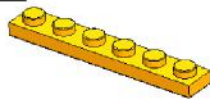

 x6

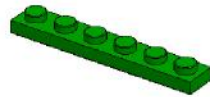
 x2

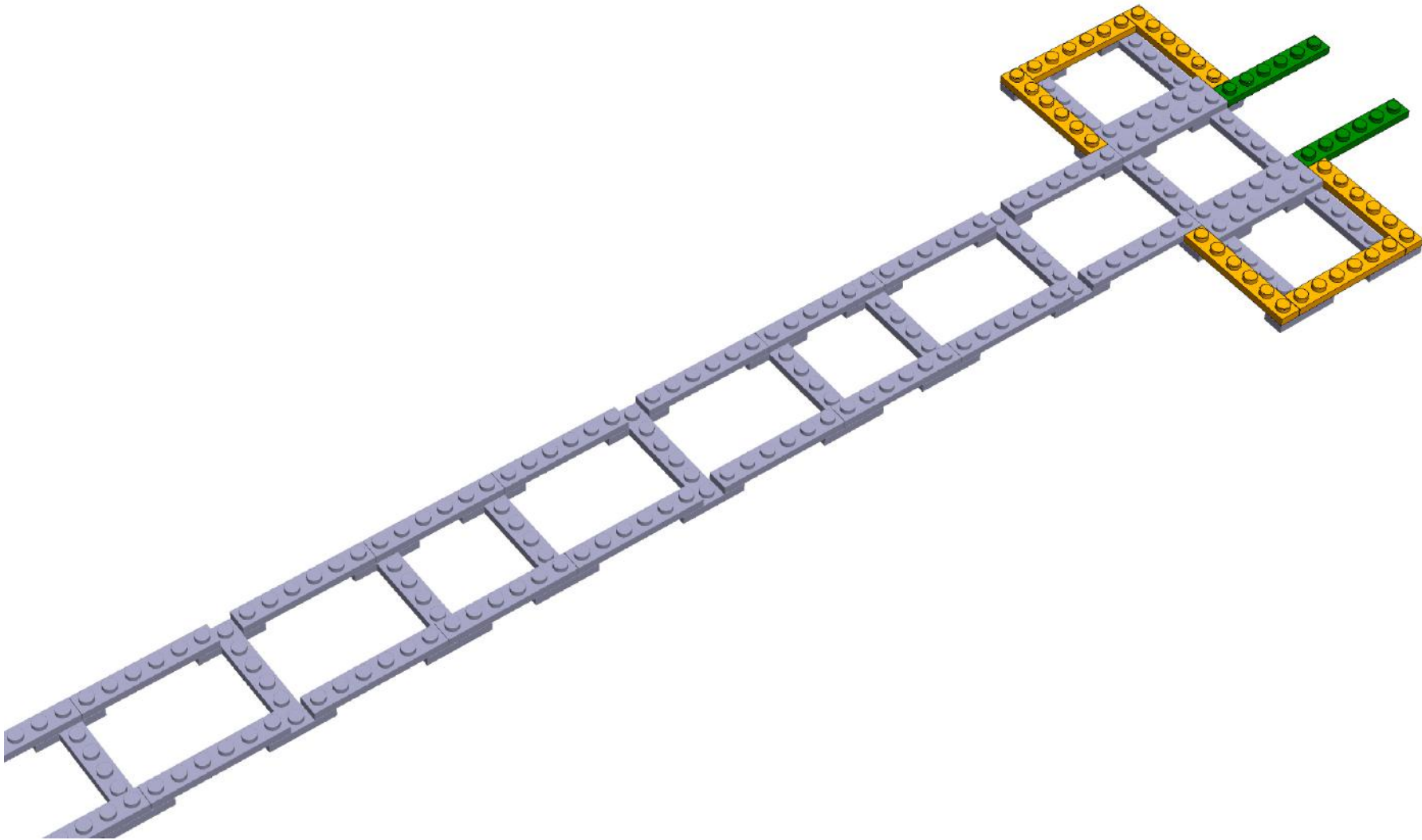

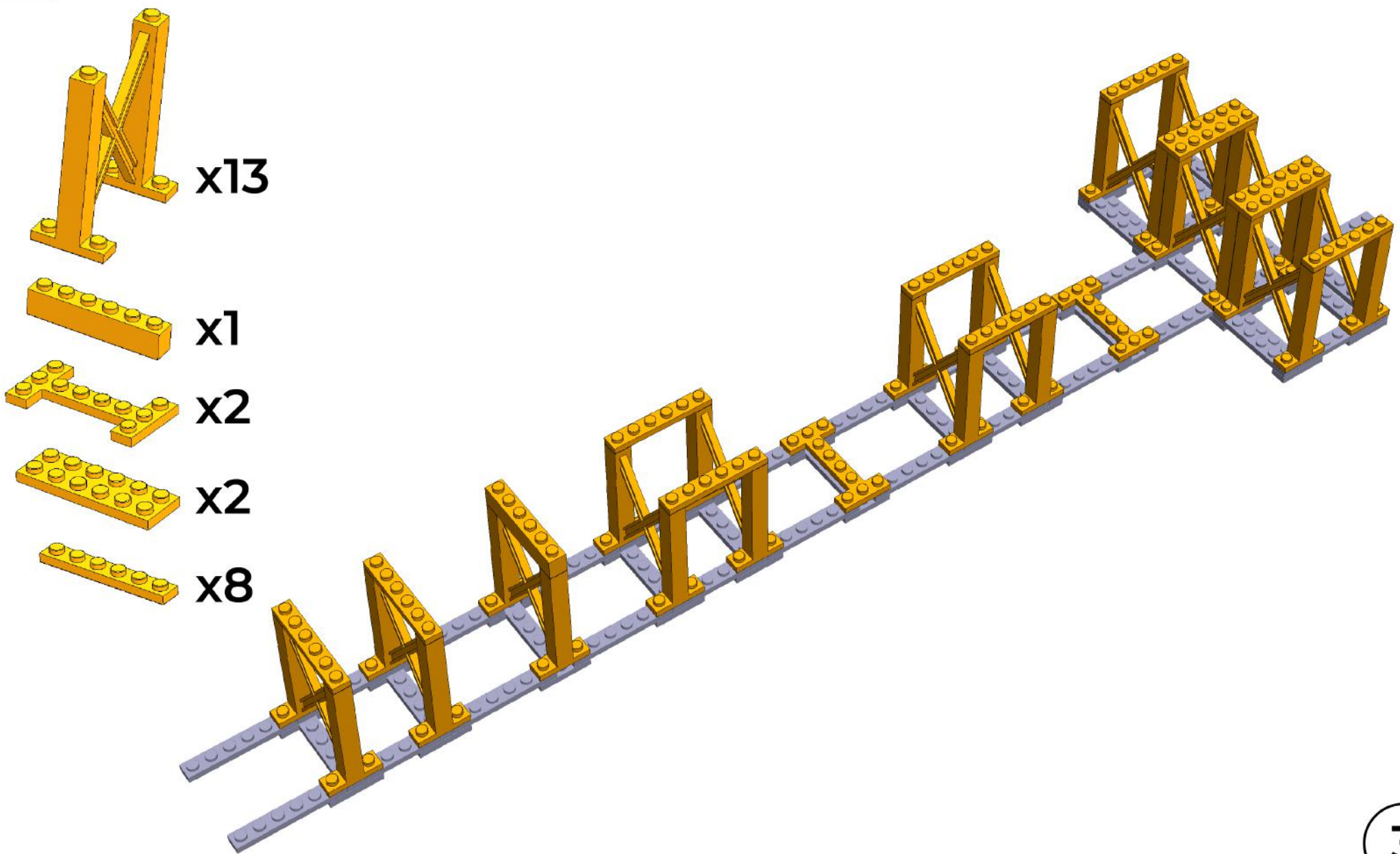

x13

x1

x2

x2

x8

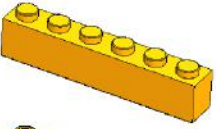

 x4

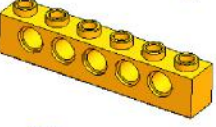
 x4

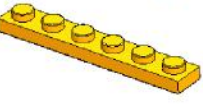
 x4

 x2

 x2

 x4

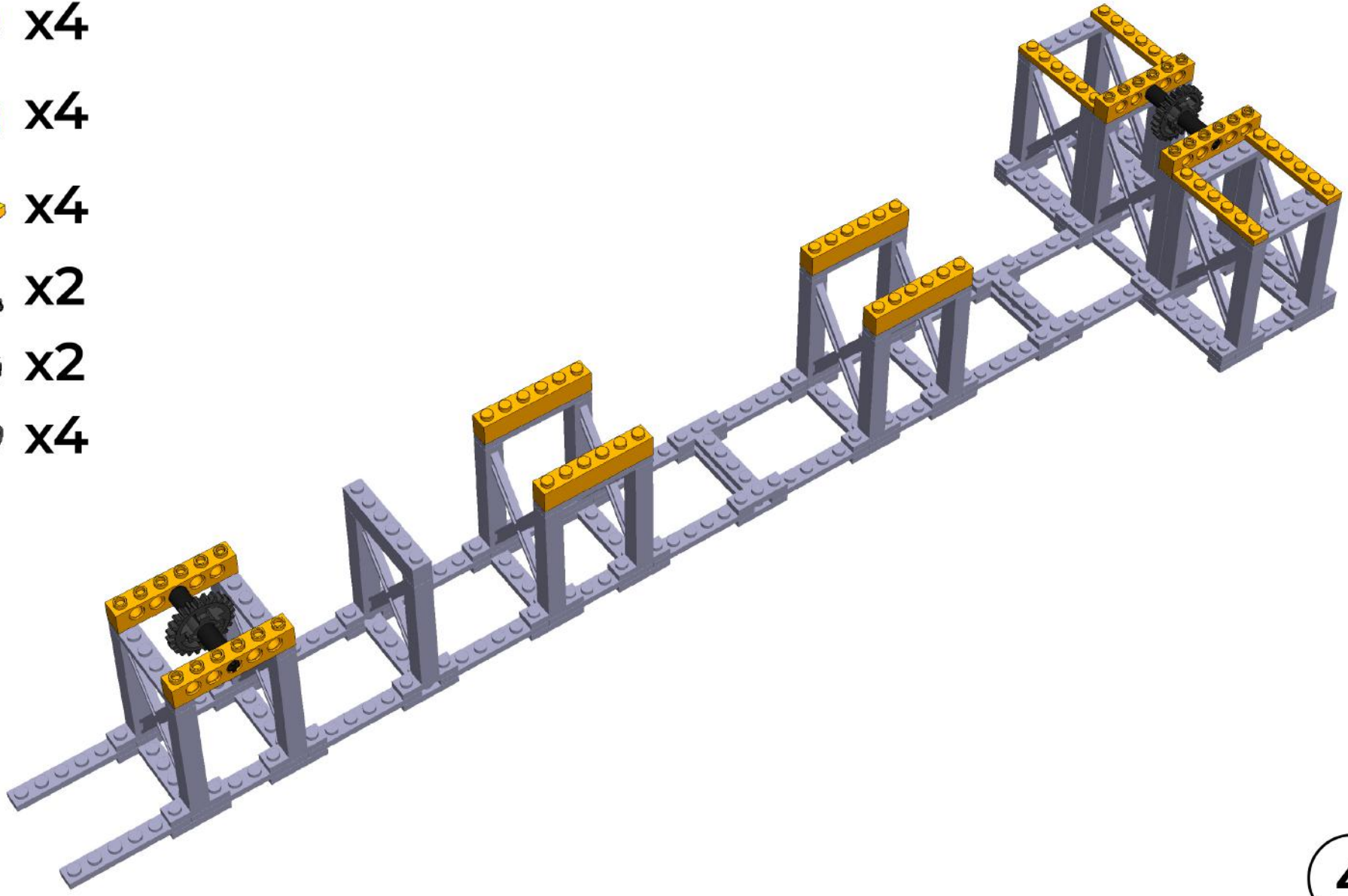

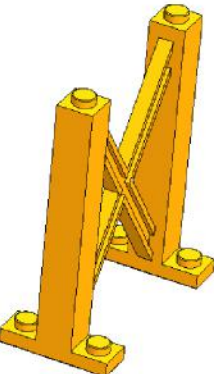
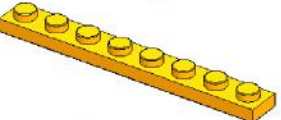
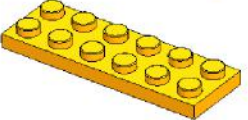
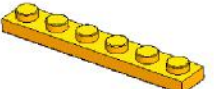

-  x7
-  x2
-  x1
-  x8

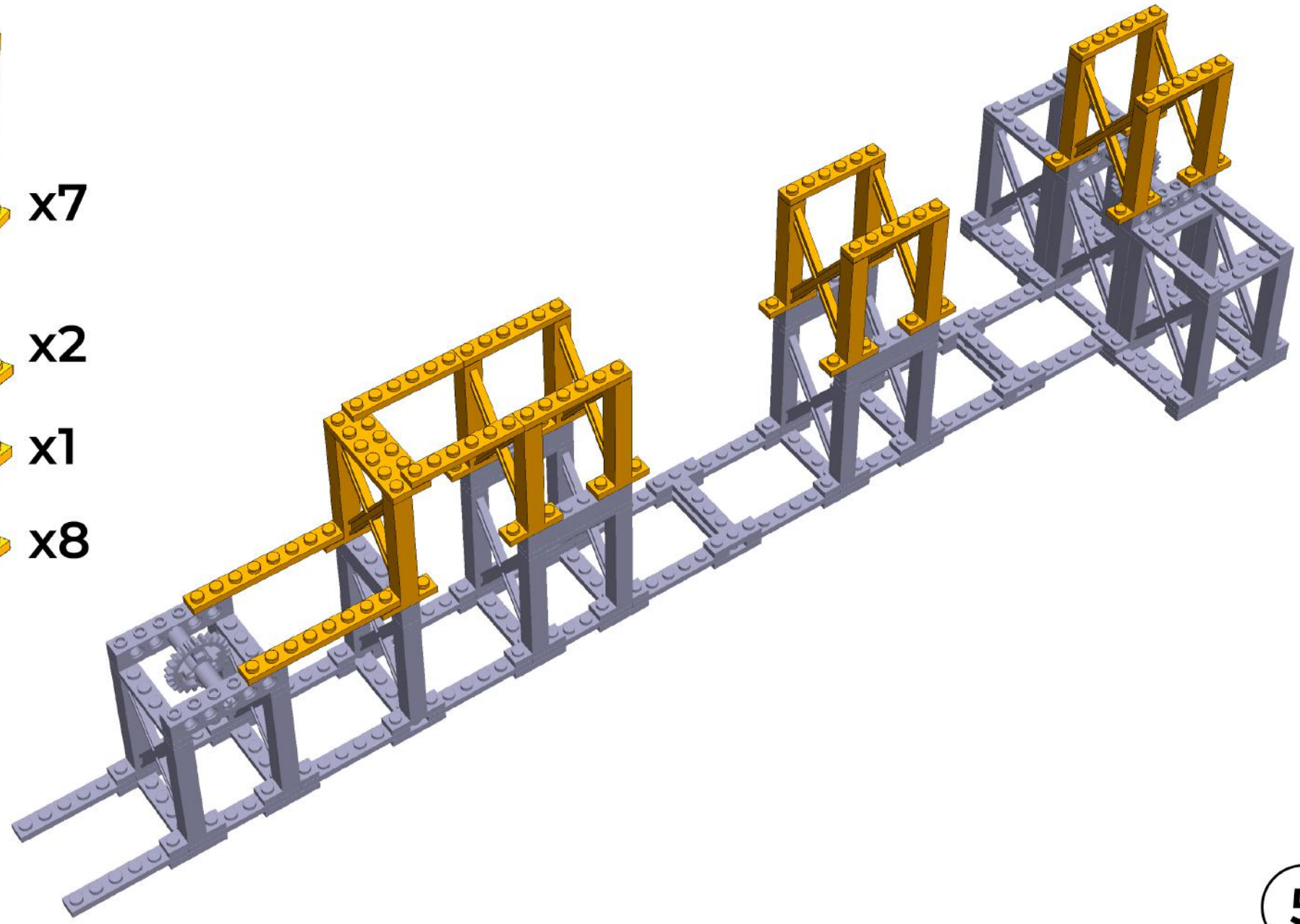

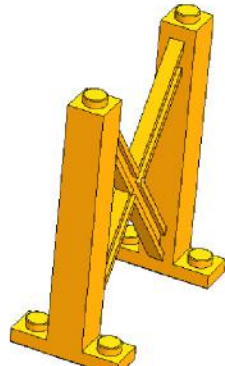
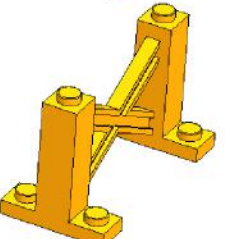
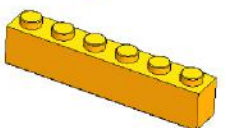
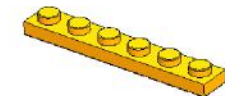

-  x5
-  x1
-  x2
-  x5

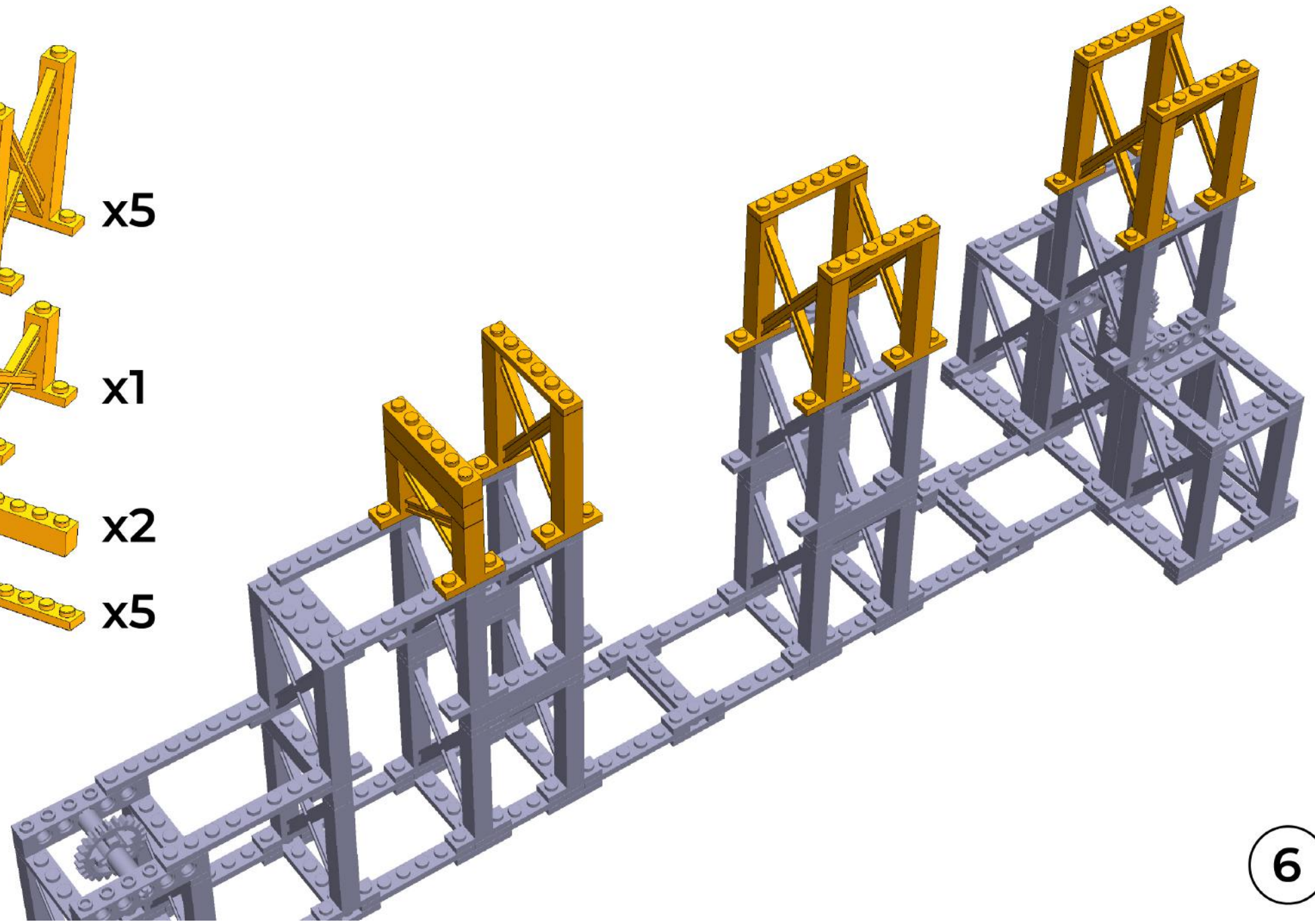



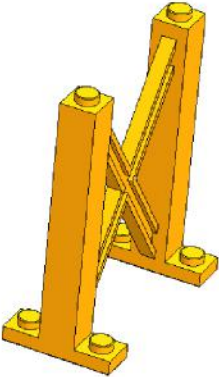
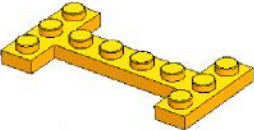
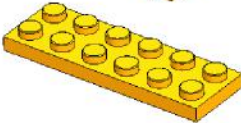
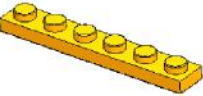

-  x4
-  x1
-  x1
-  x8

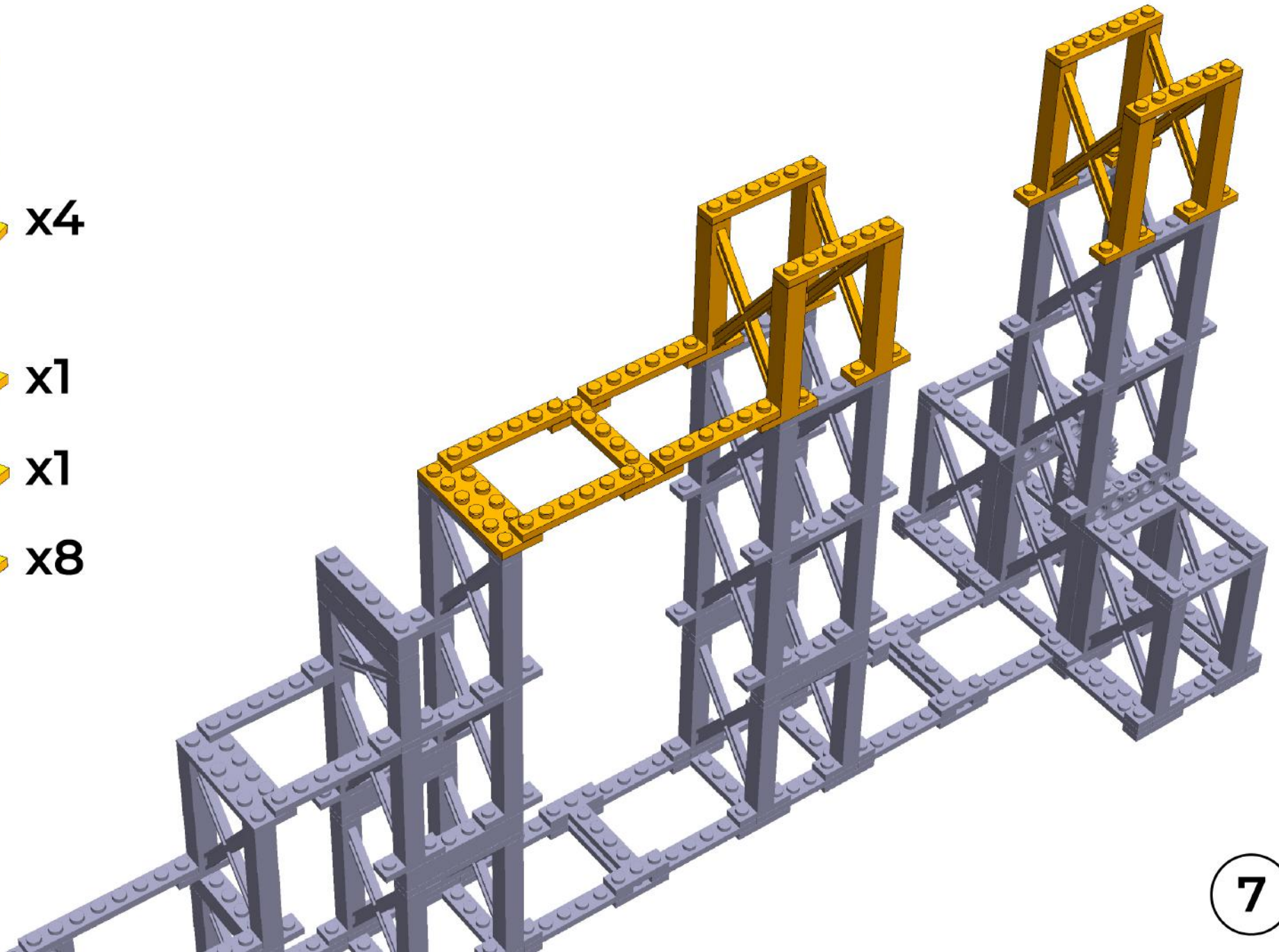

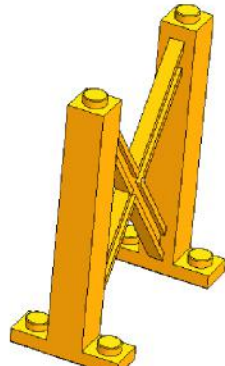
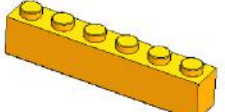
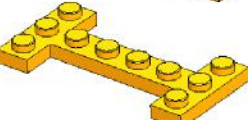
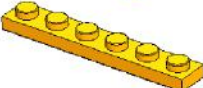

-  x4
-  x2
-  x1
-  x4

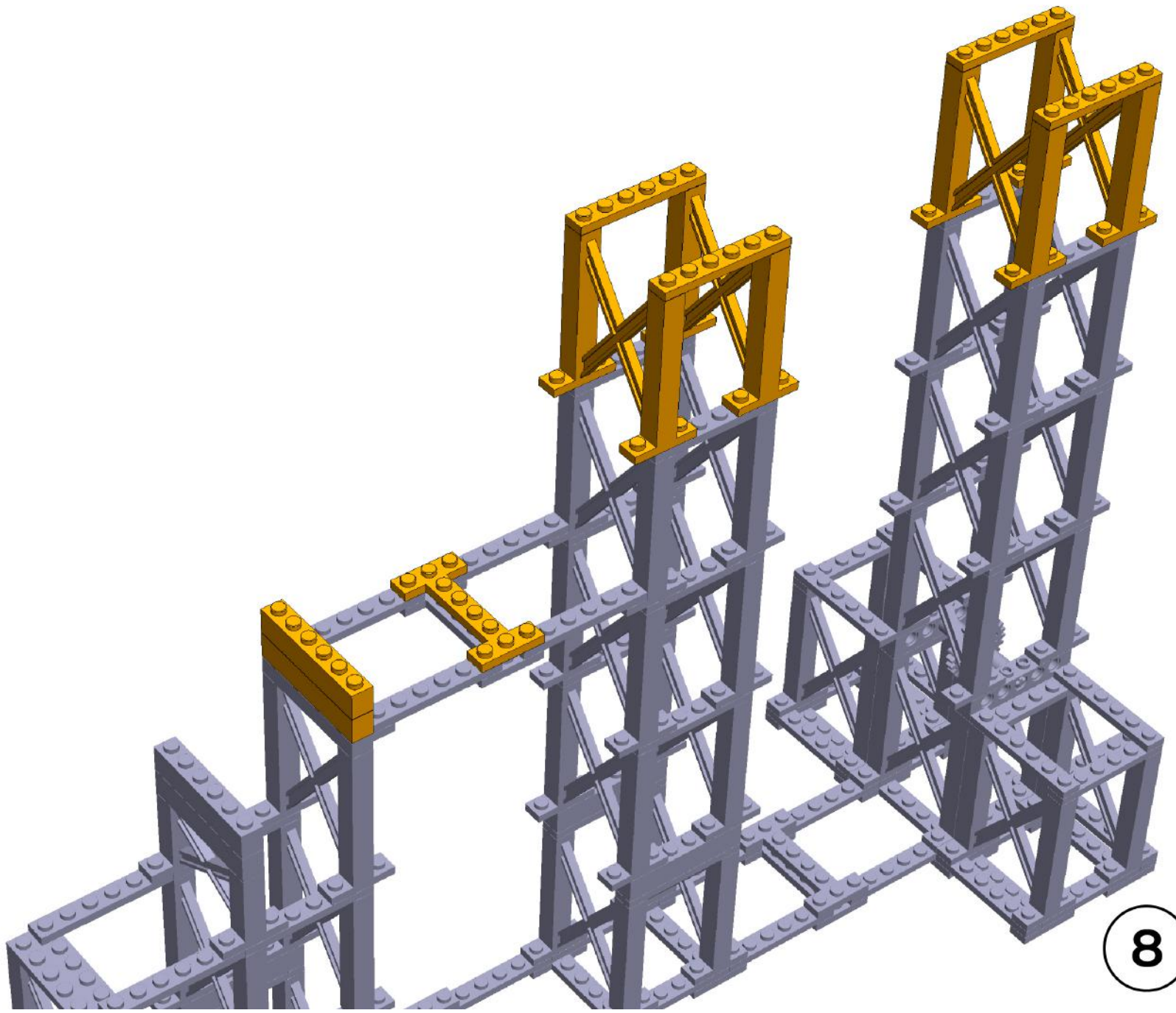

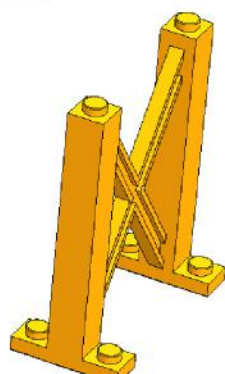
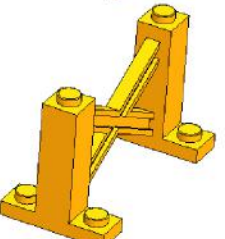
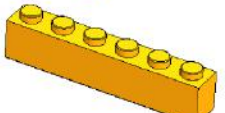
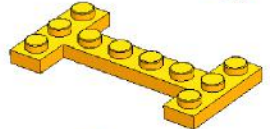
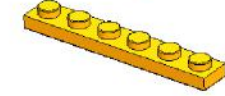

-  x2
-  x1
-  x1
-  x1
-  x7

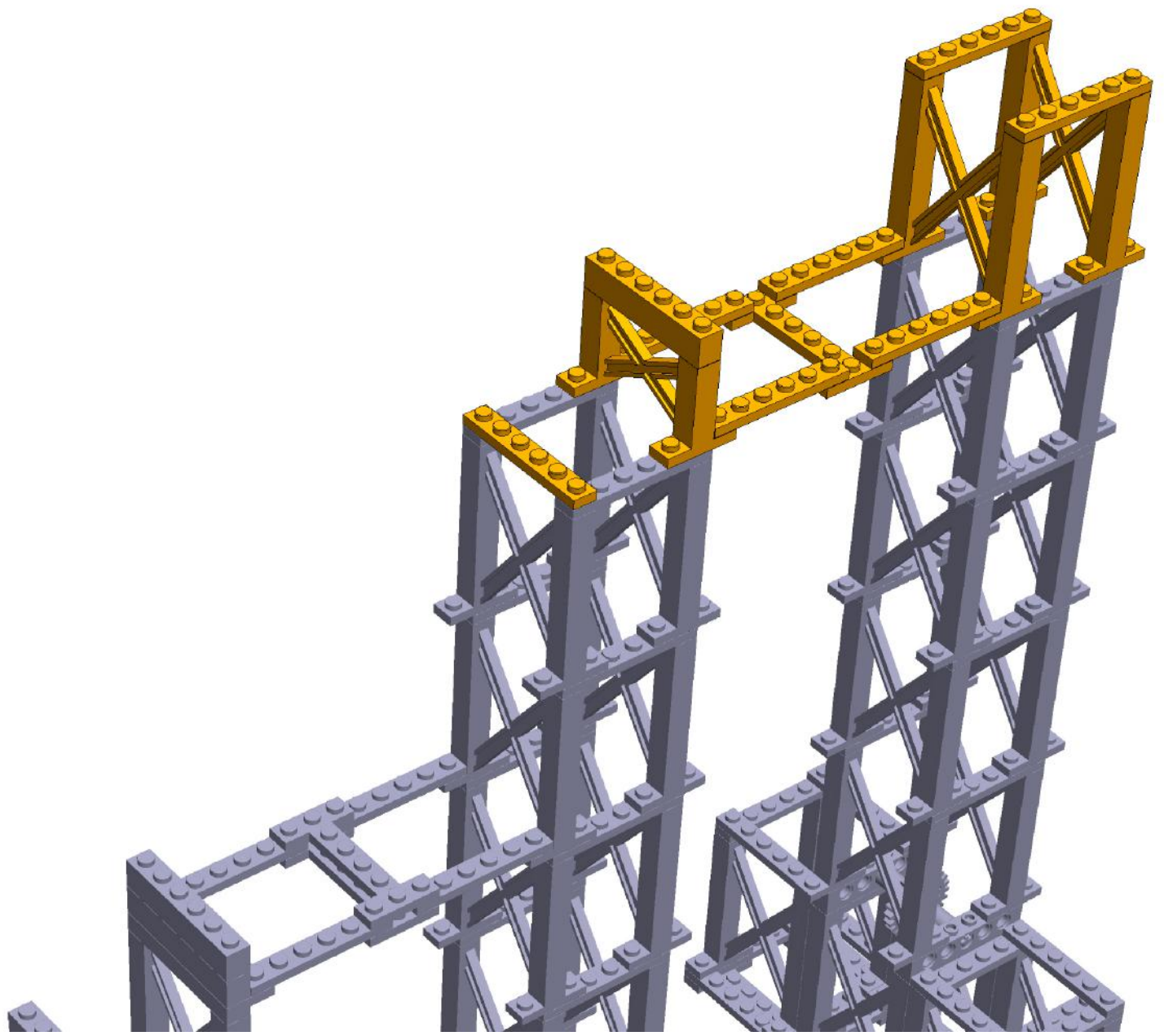

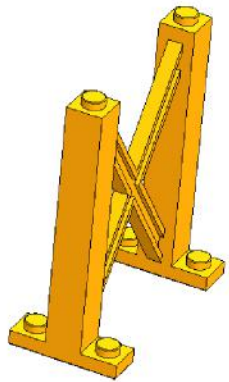

x2

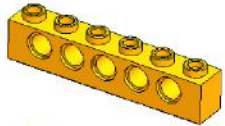

x2

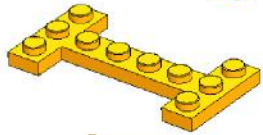

x1

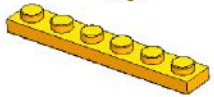

x2



x1



x1



x1



x2

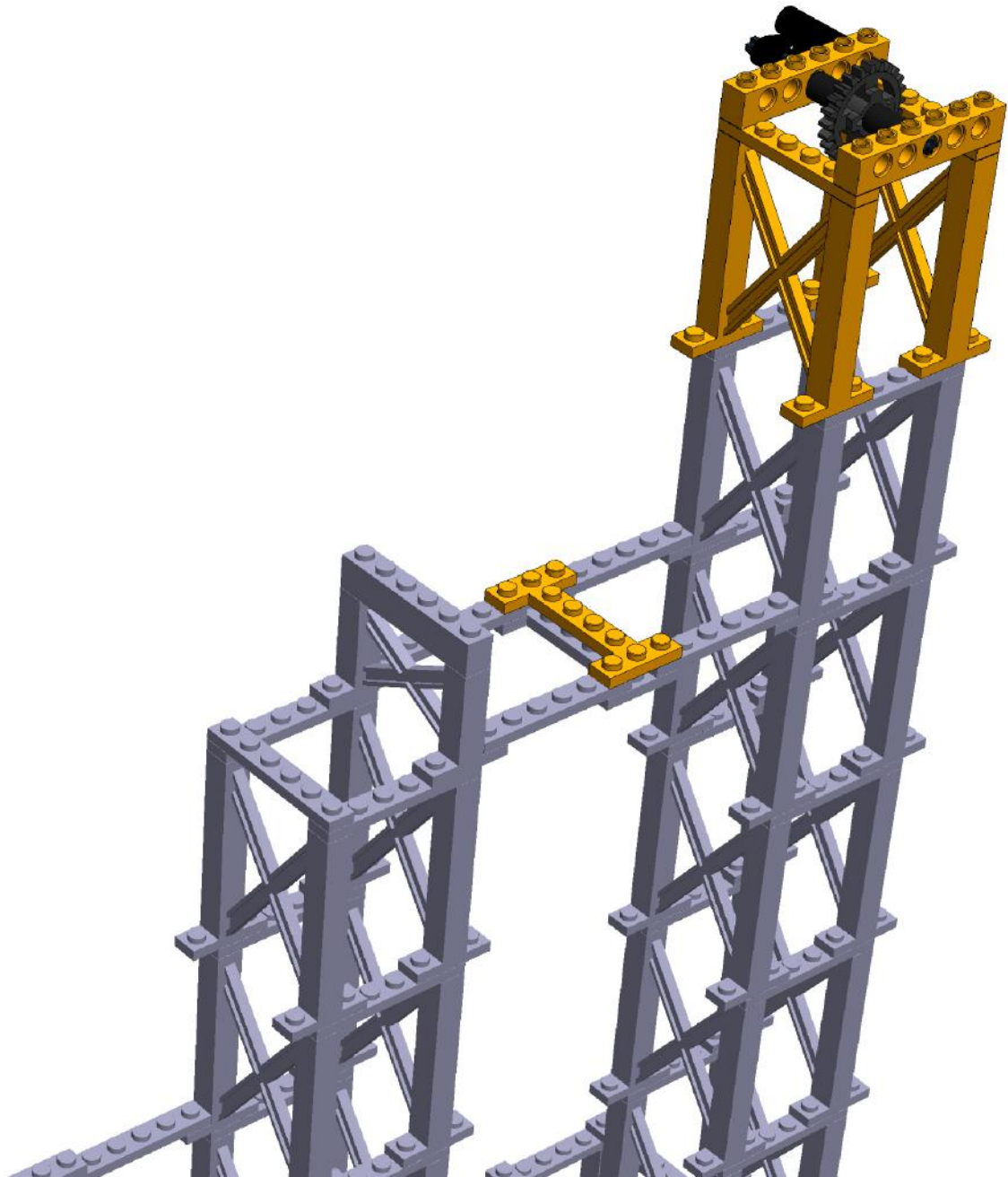

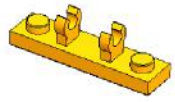

x8

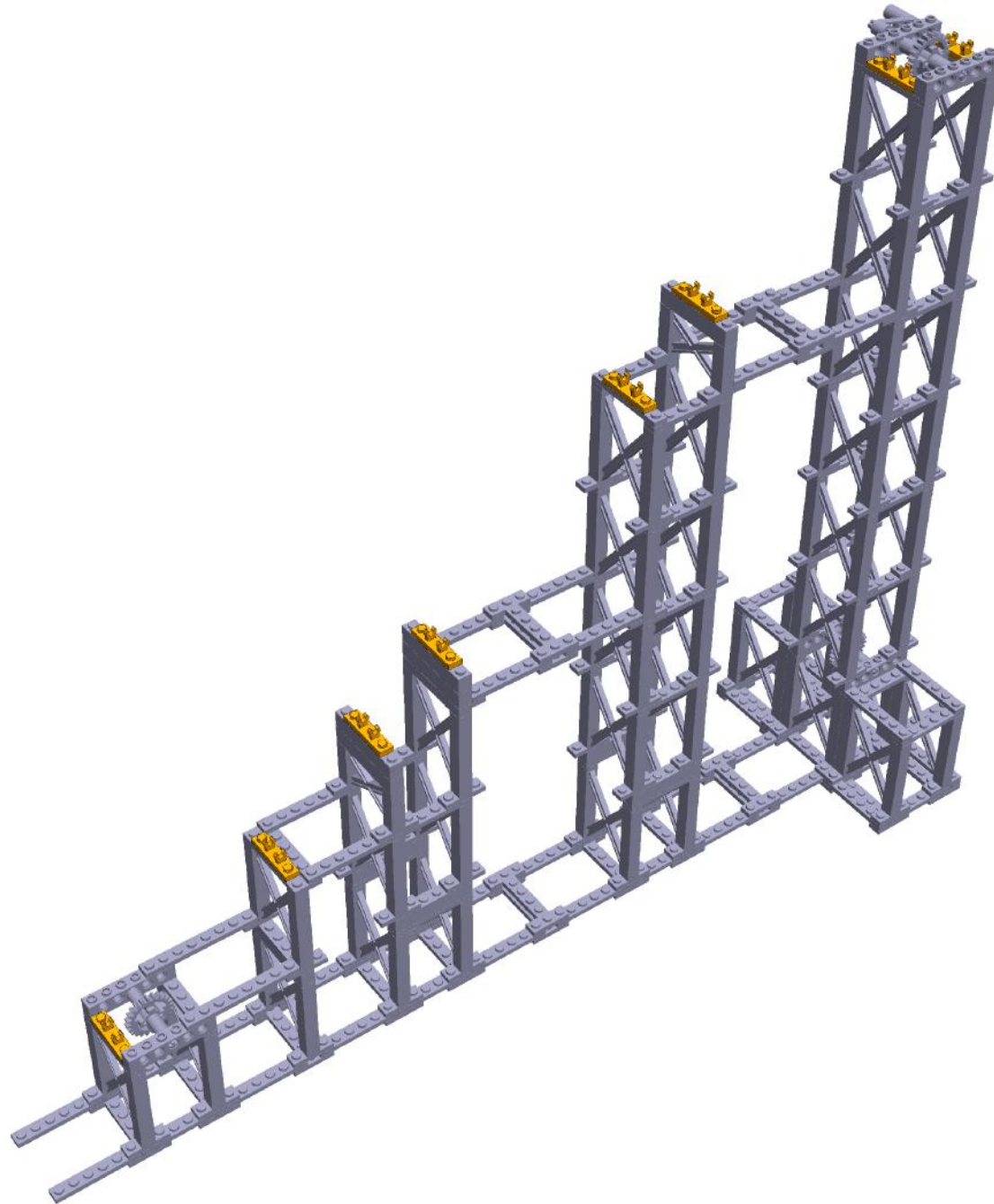

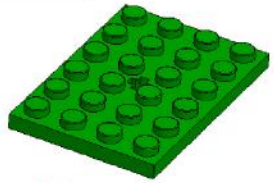

x8



x1

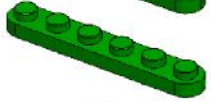

x8



x7

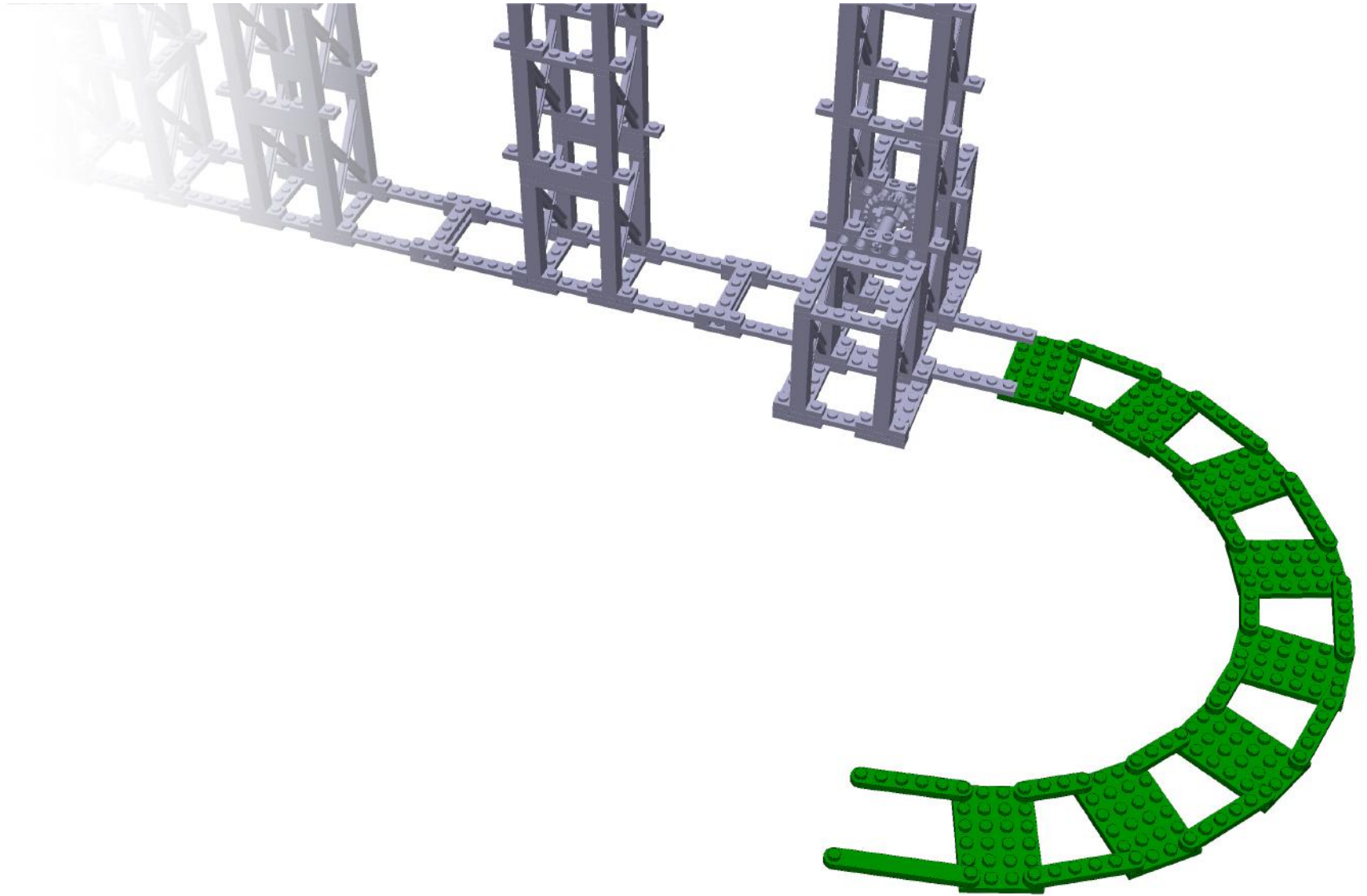



x8

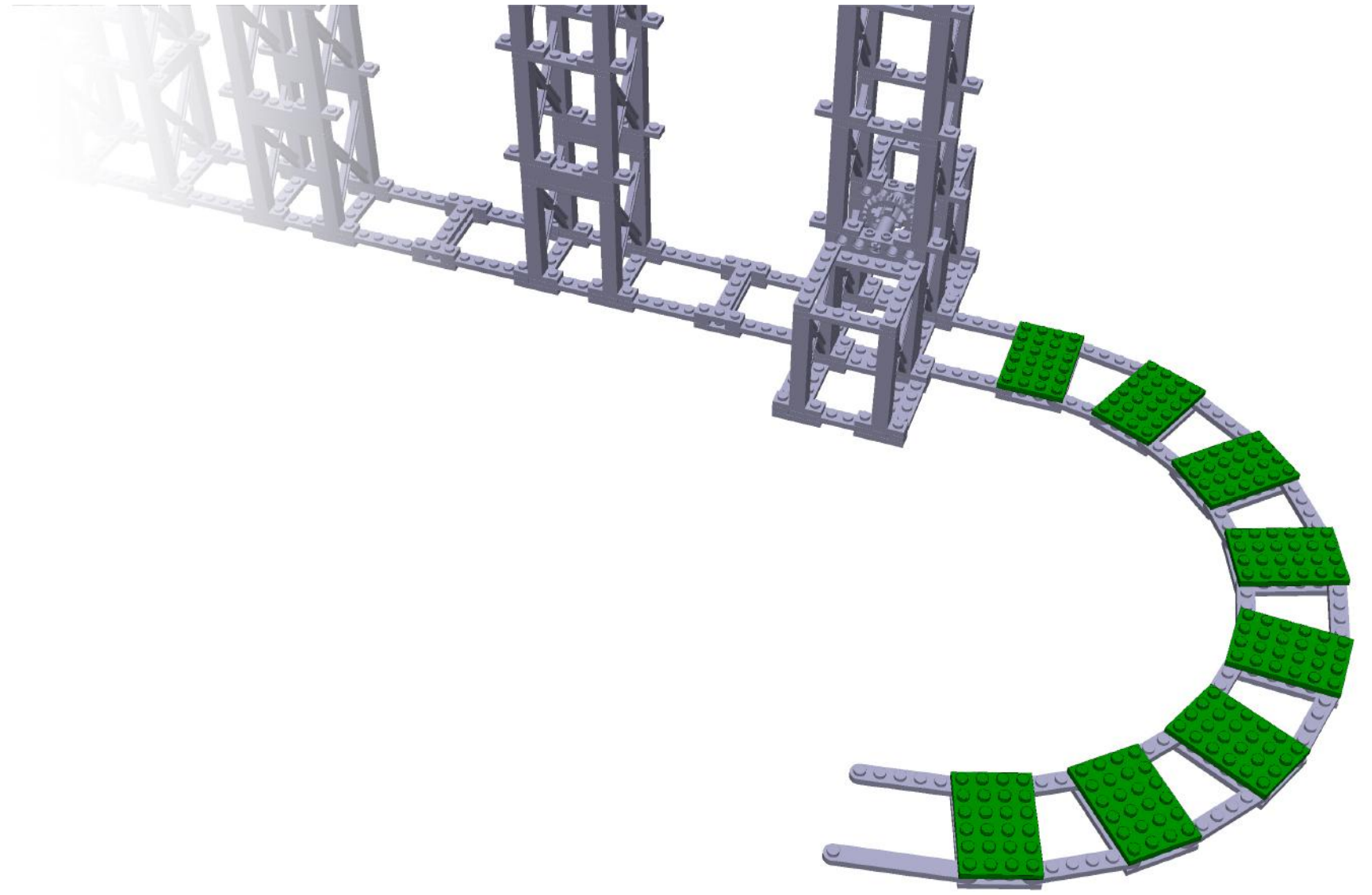



x14

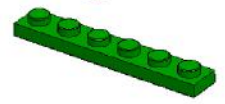

x12

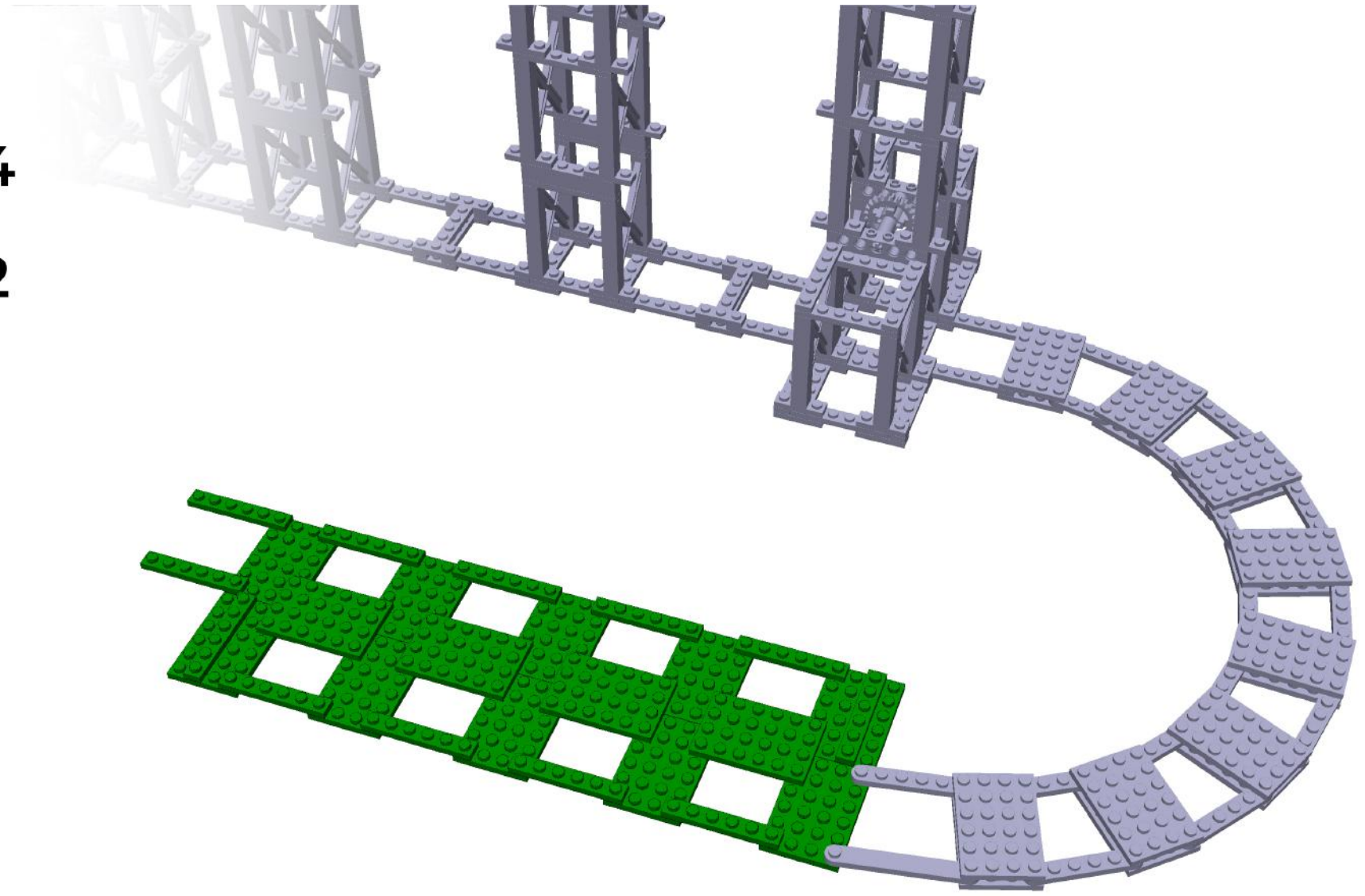





x10

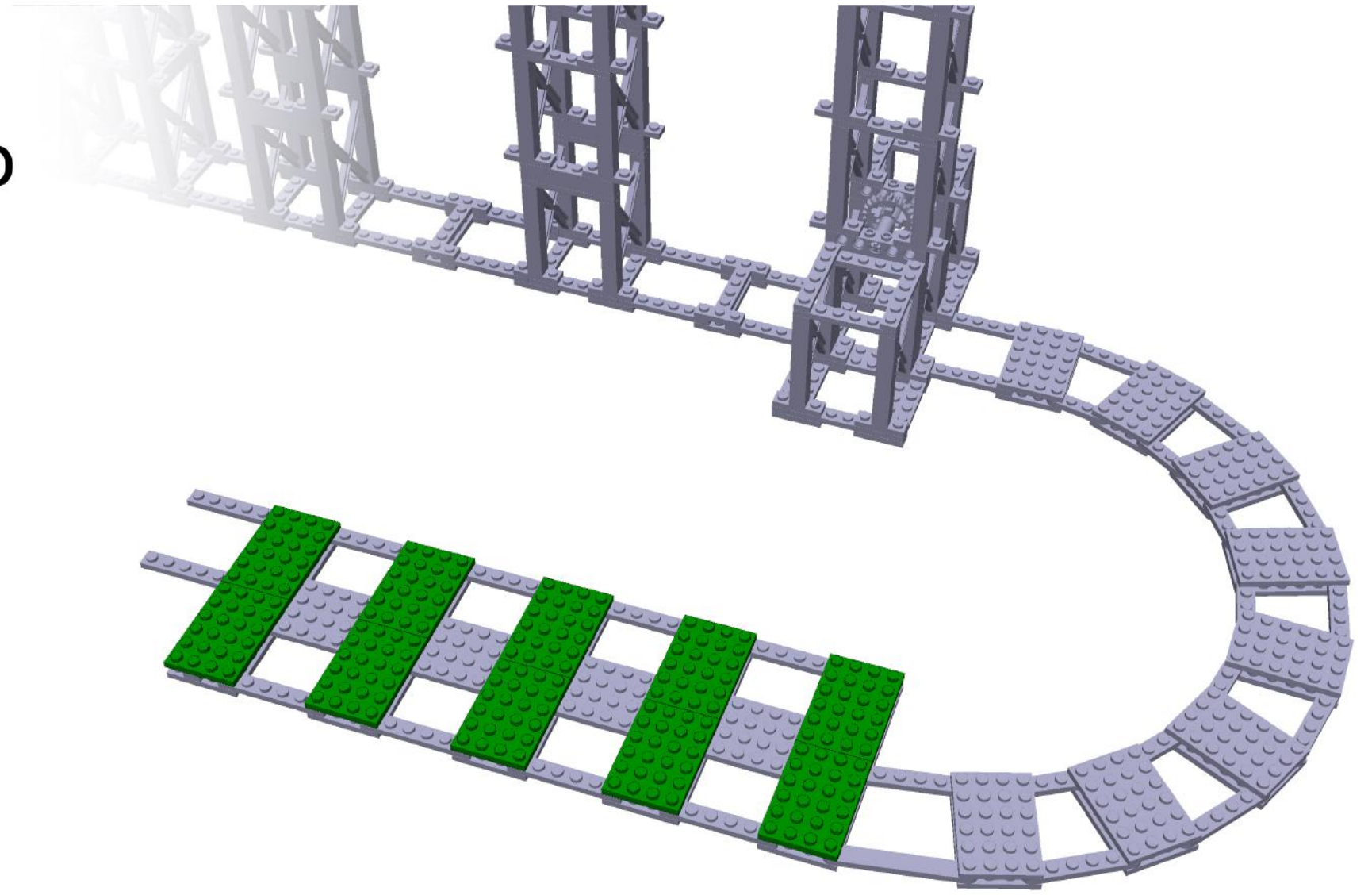

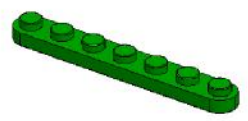

x13

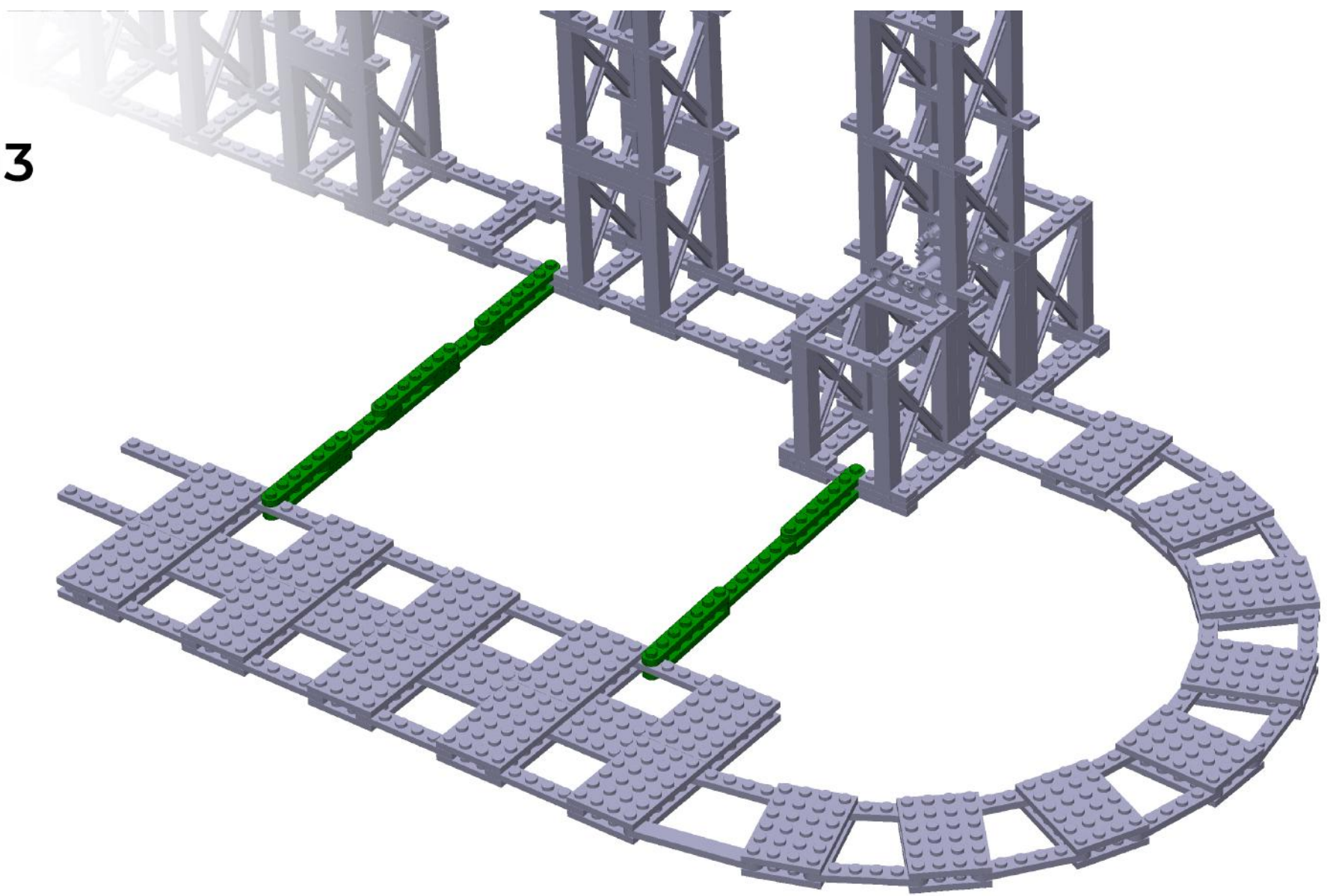



x14



x1

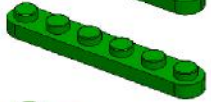

x10



x6



x9

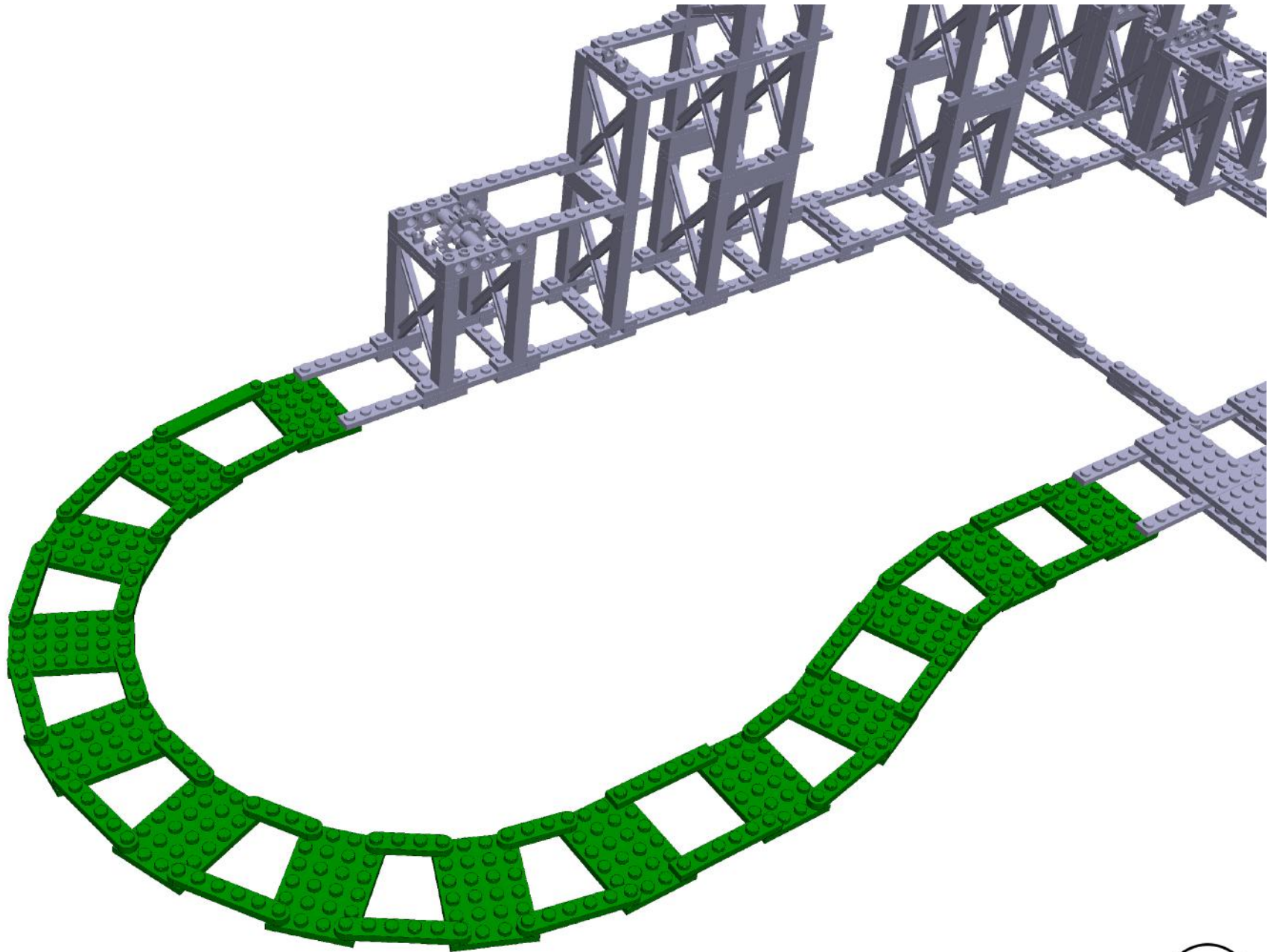



x14

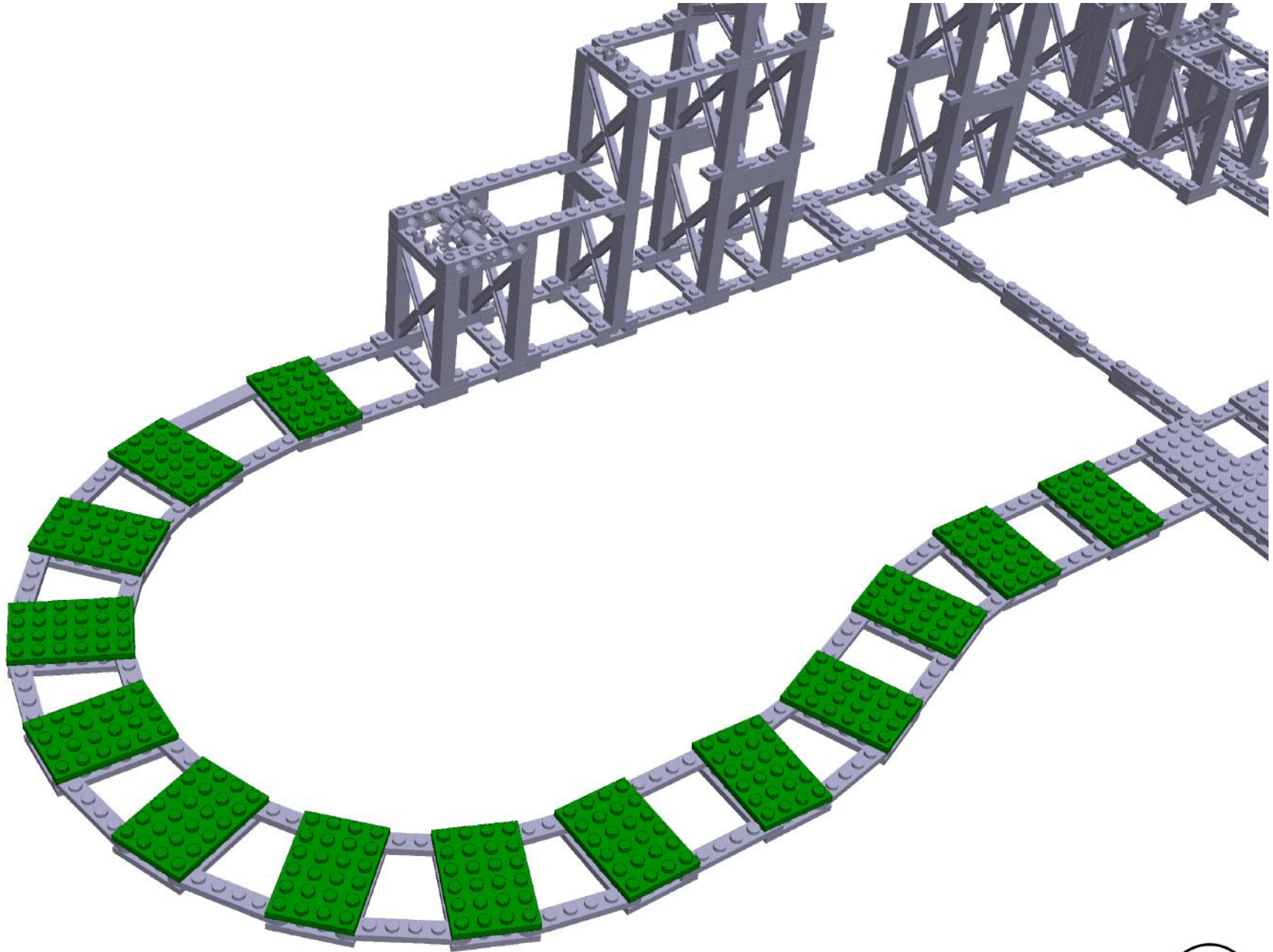

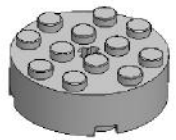

x12



x8

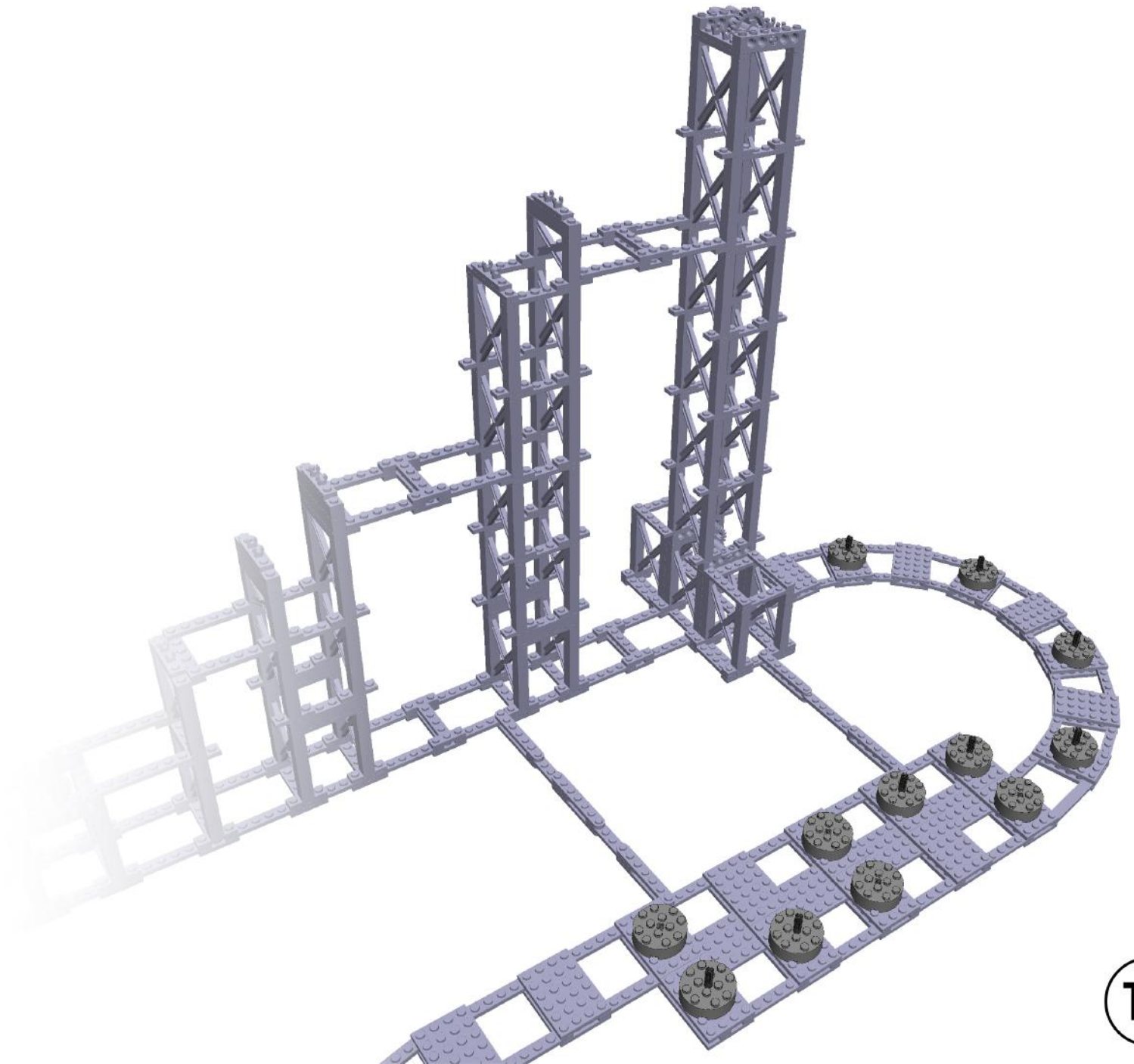



x5



x3



x5

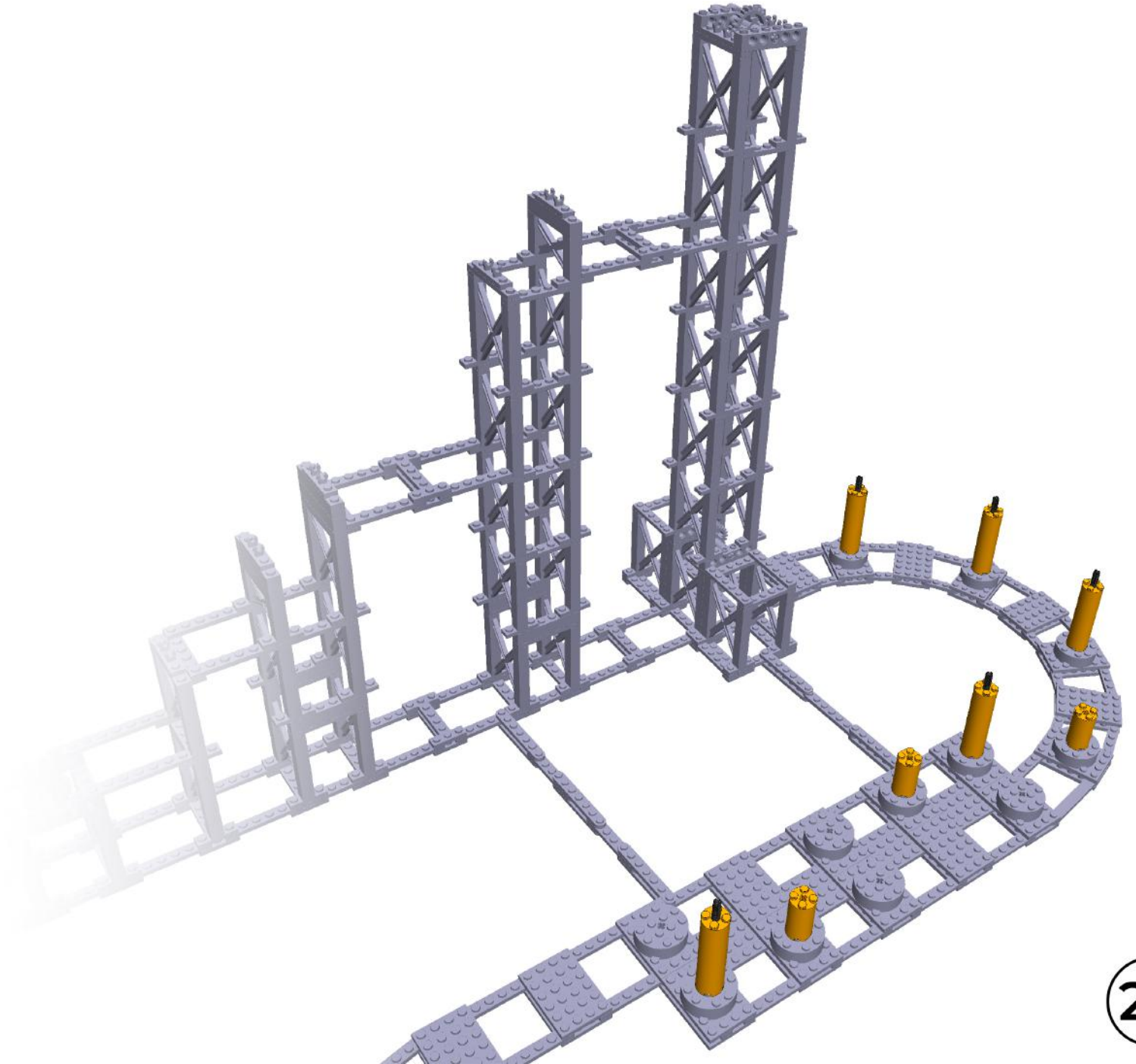



x5



x4

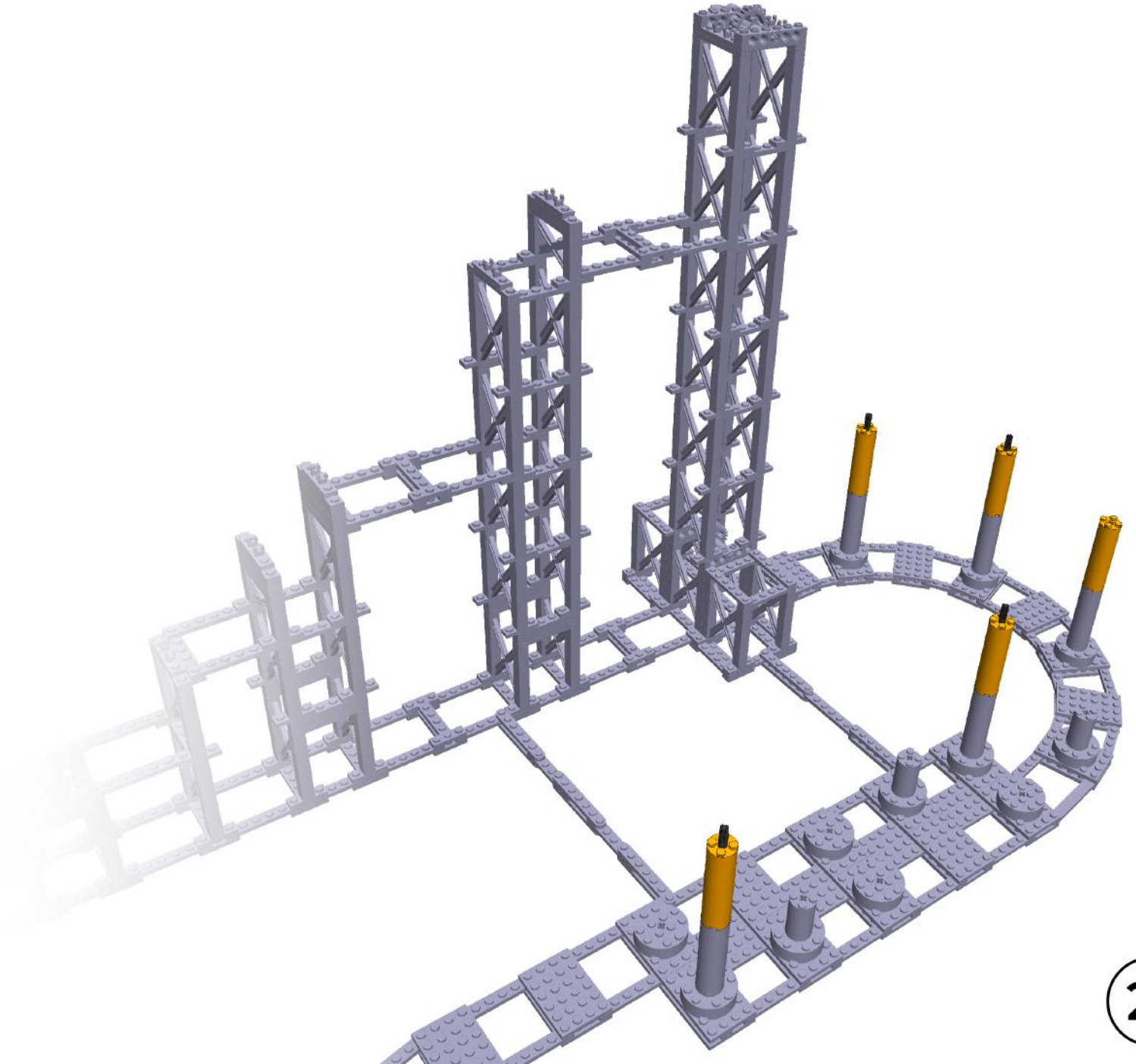



x2



x2



x2

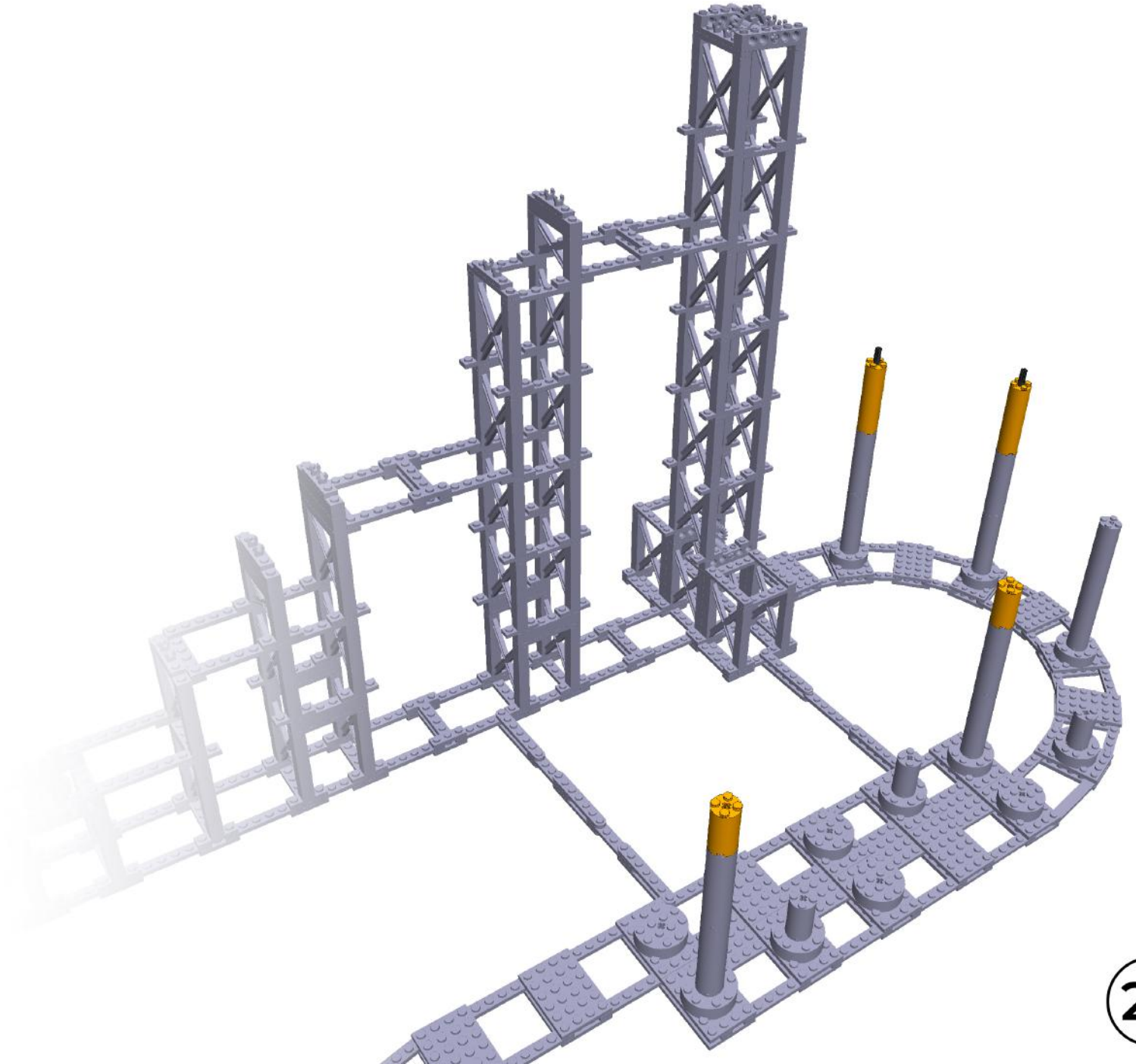





x2

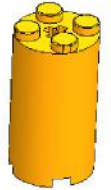

x2



x4



x4

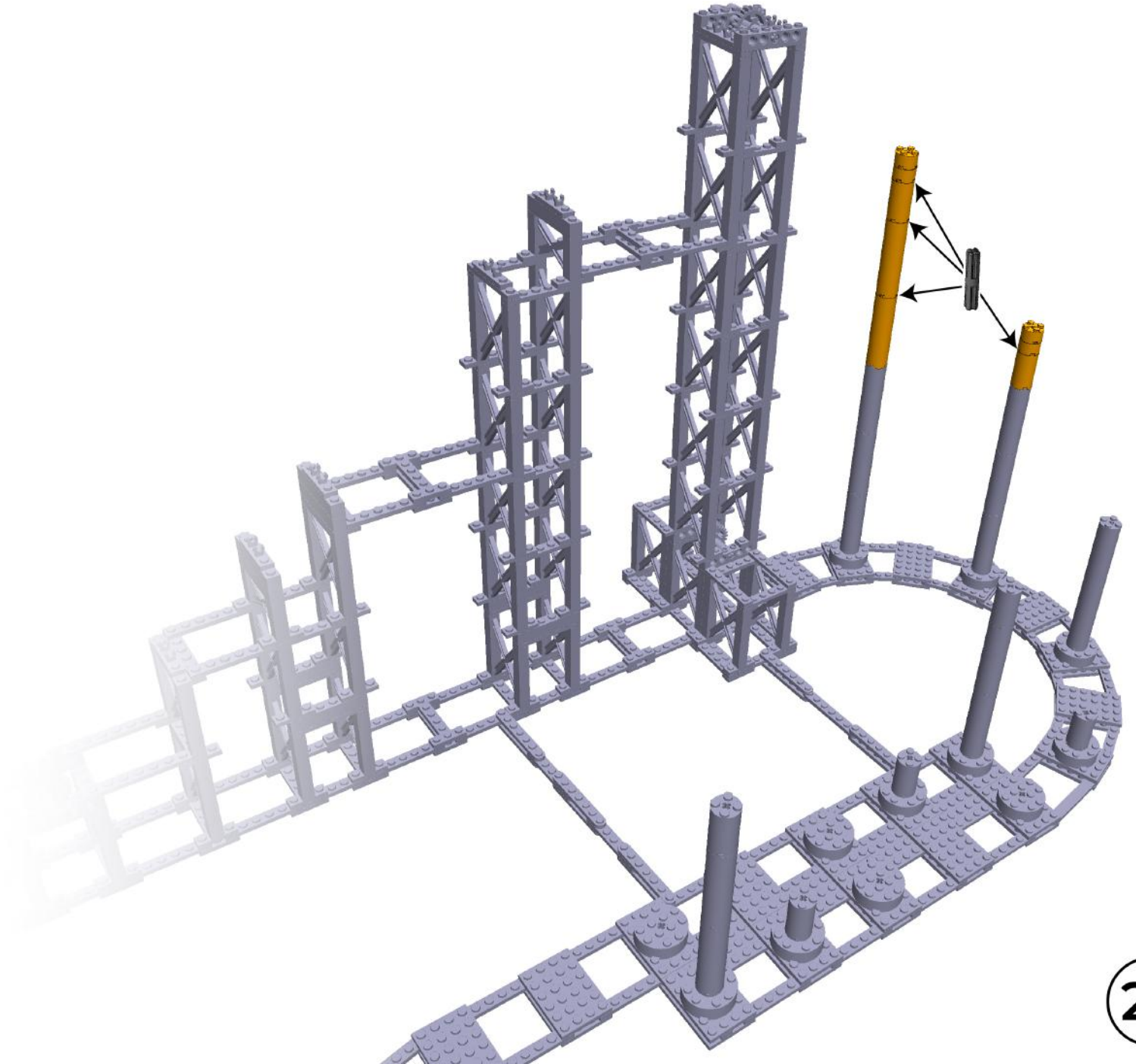



x2



x2

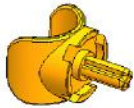

x2



x2



x2

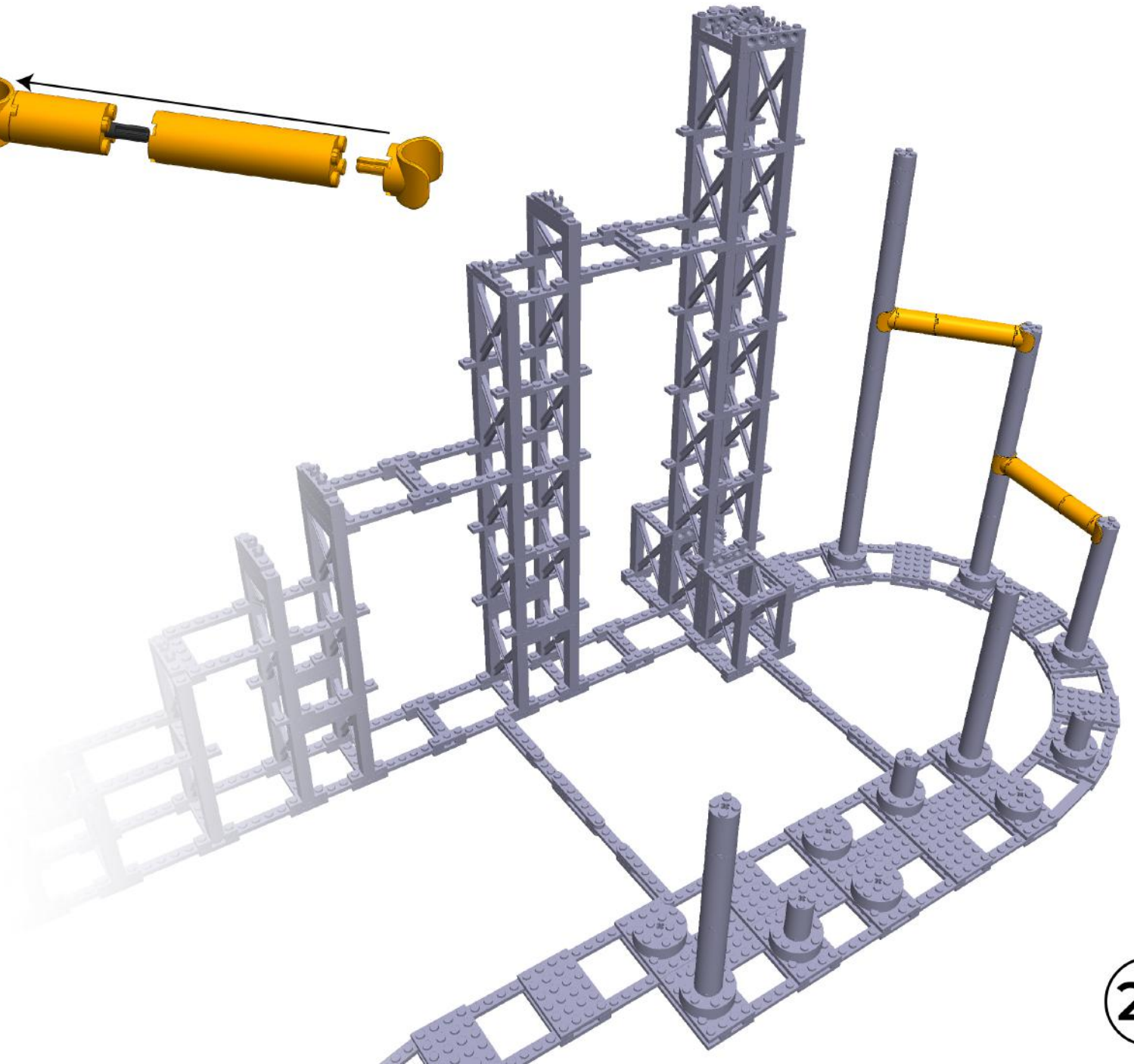
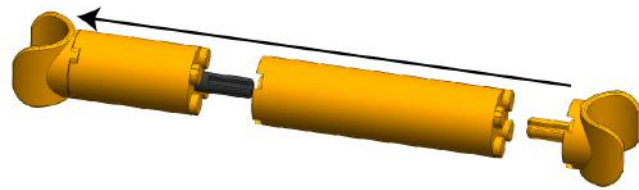

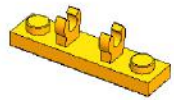

x2



x12

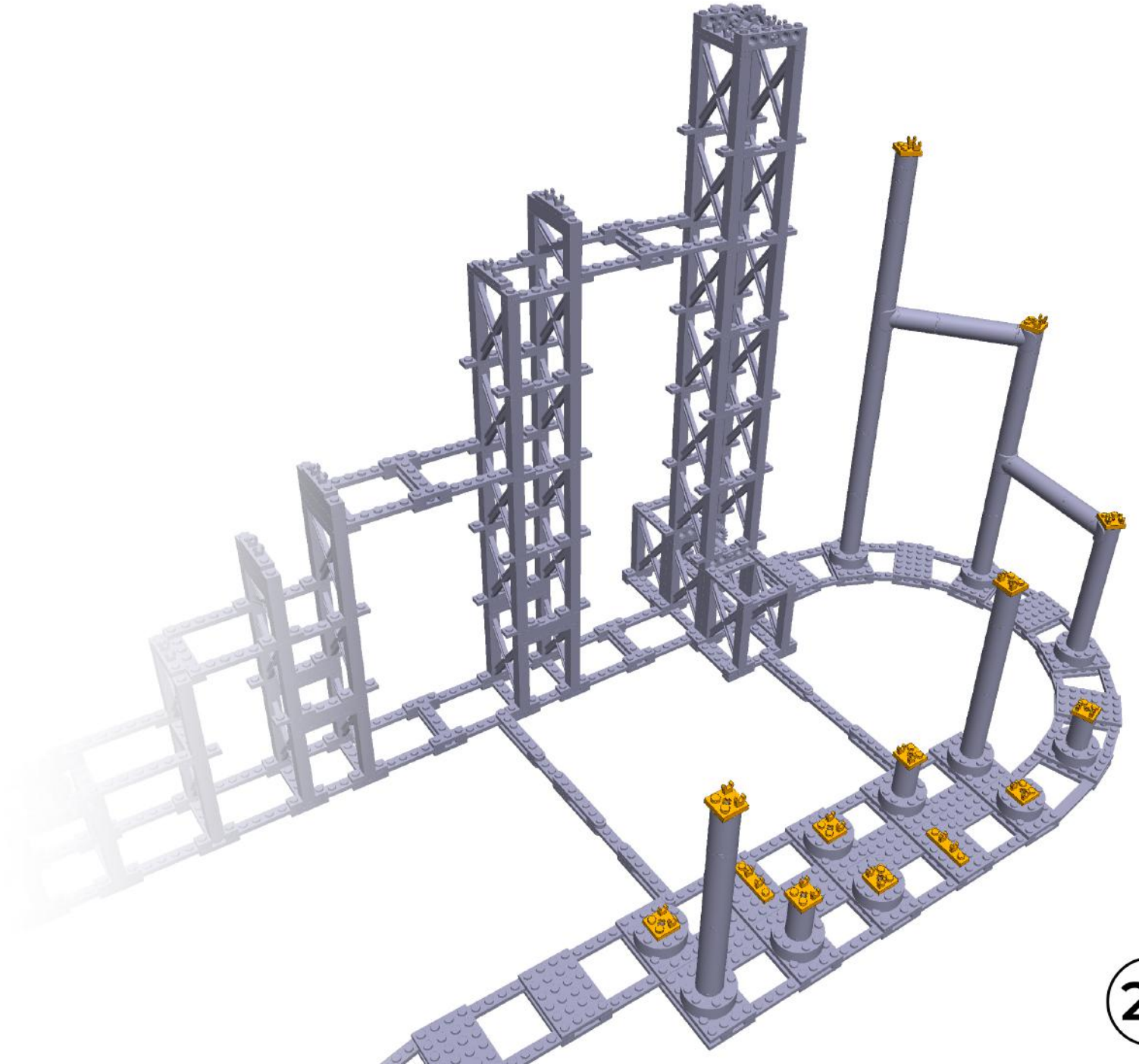

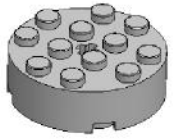

x7



x7

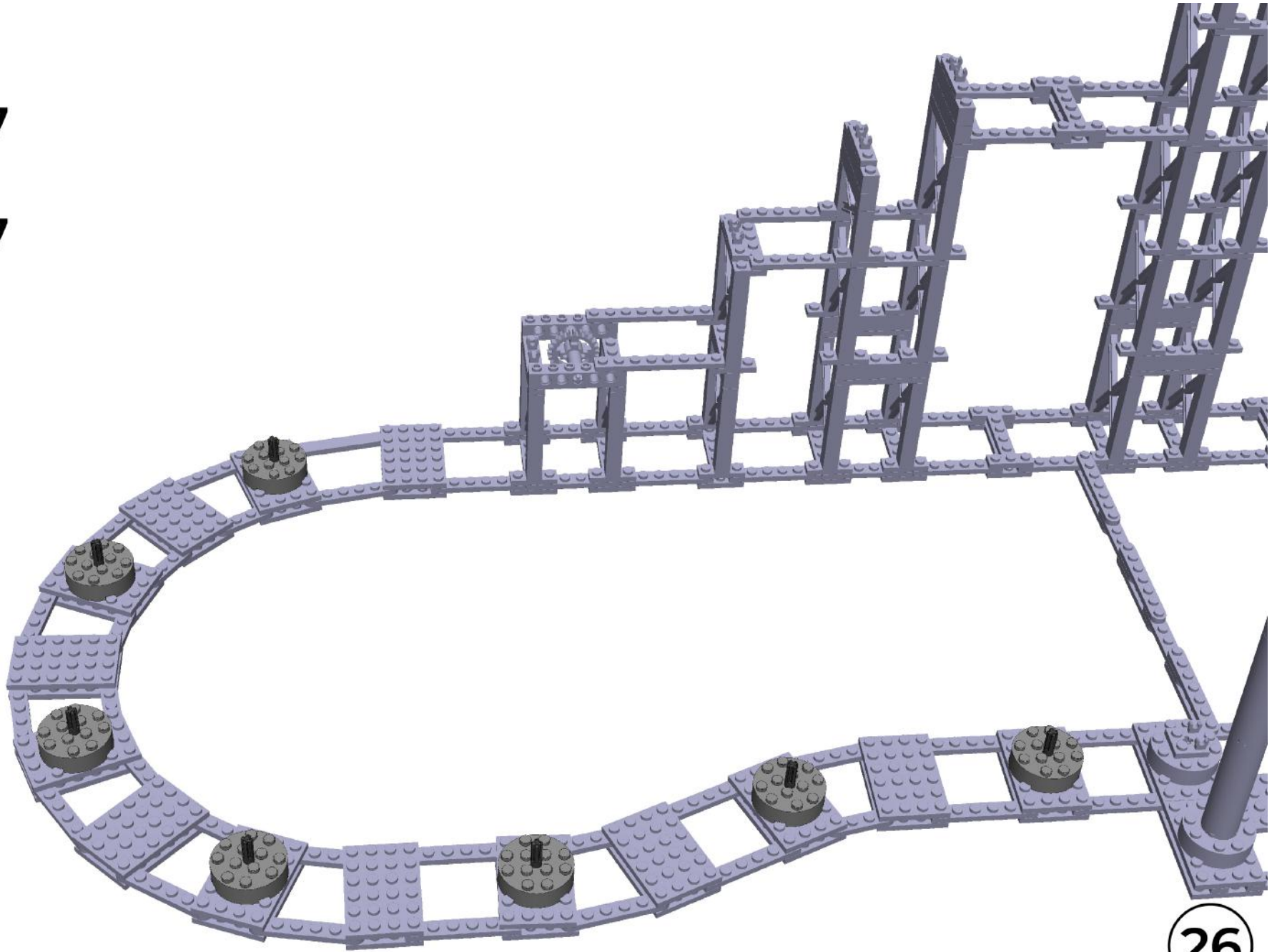



x4



x3



x5

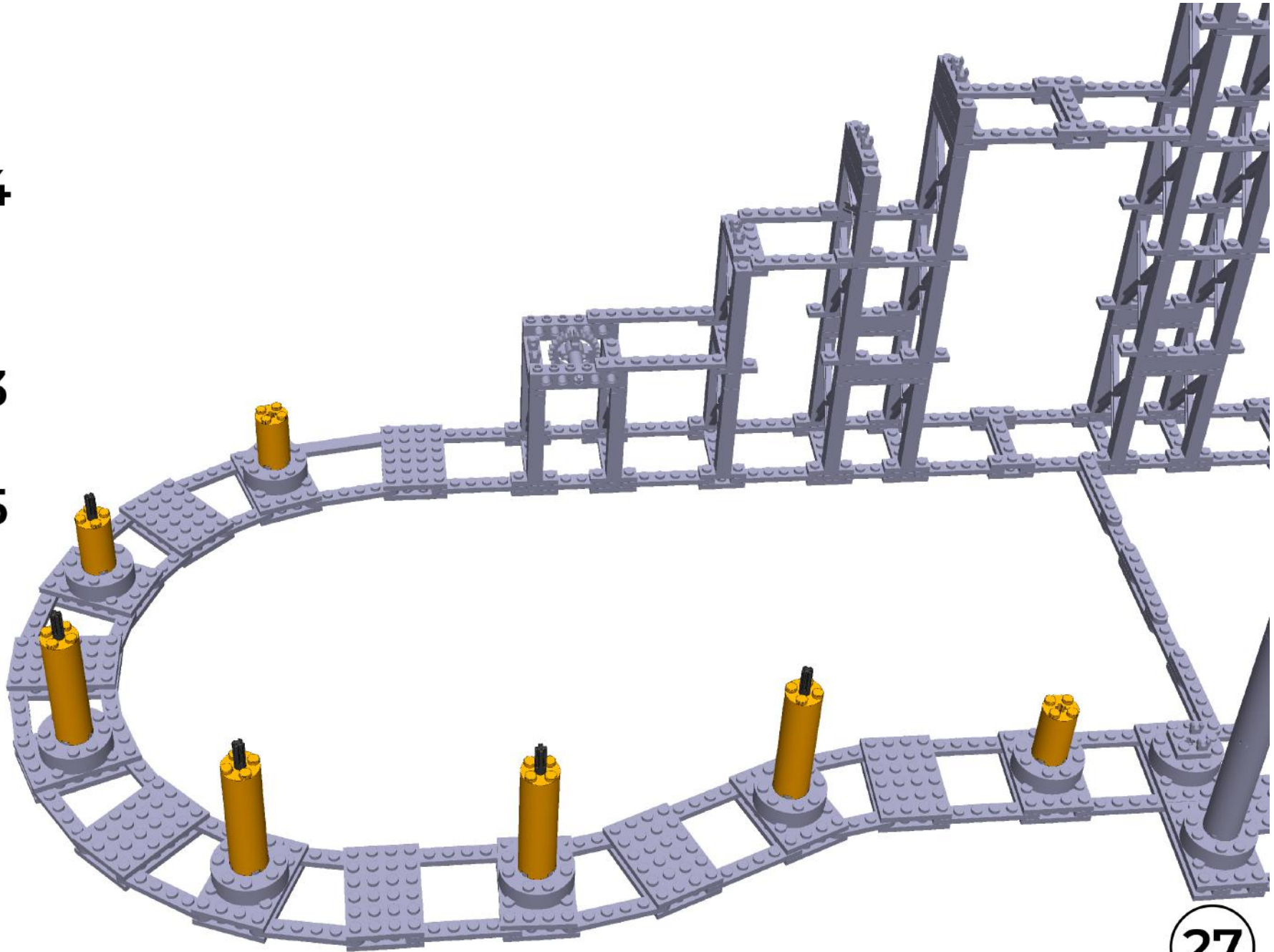



x3



x1



x3



x2

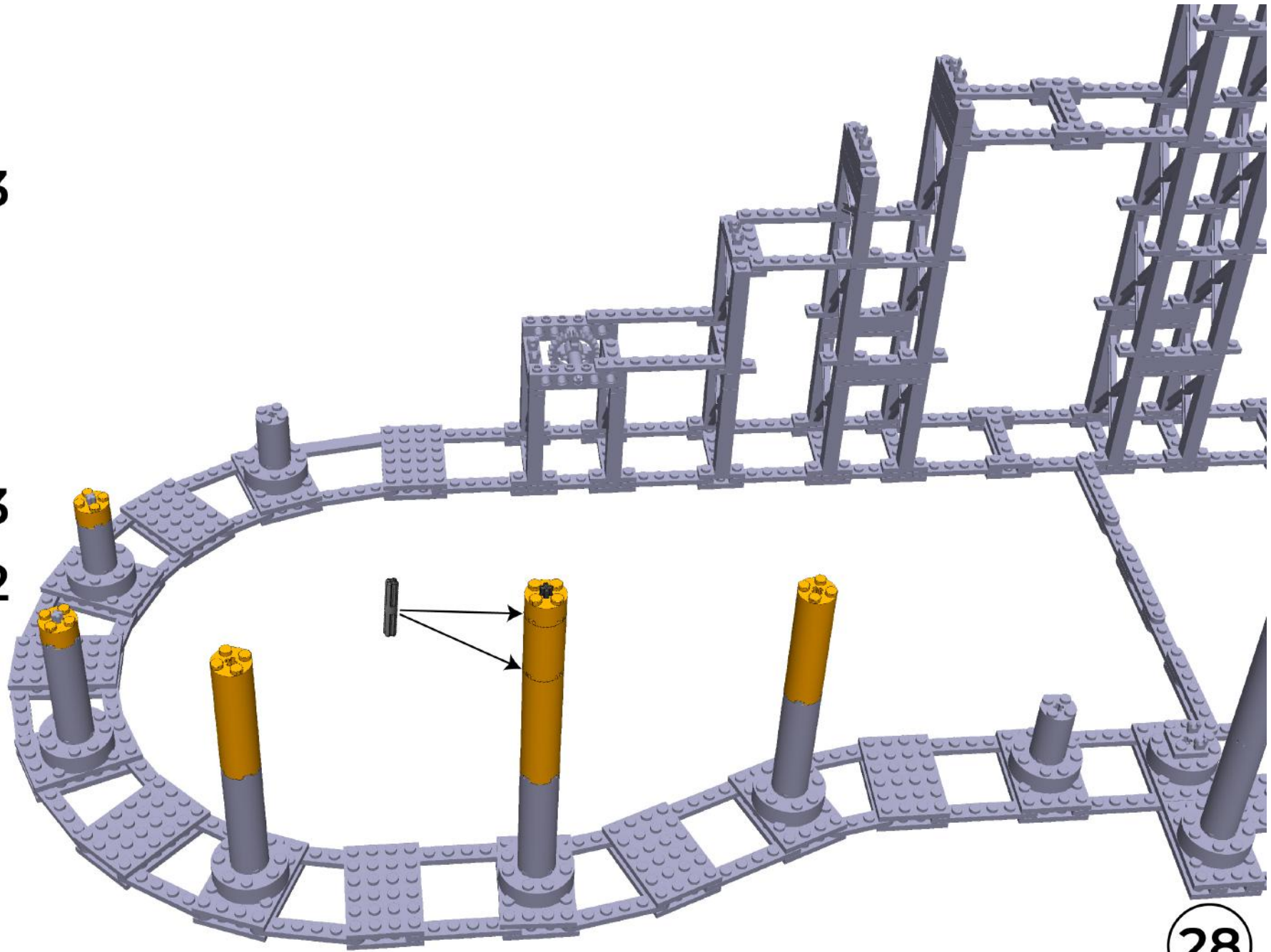

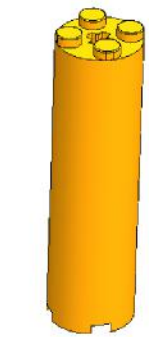

x2



x2



x2

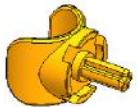

x2

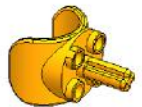

x2



x2

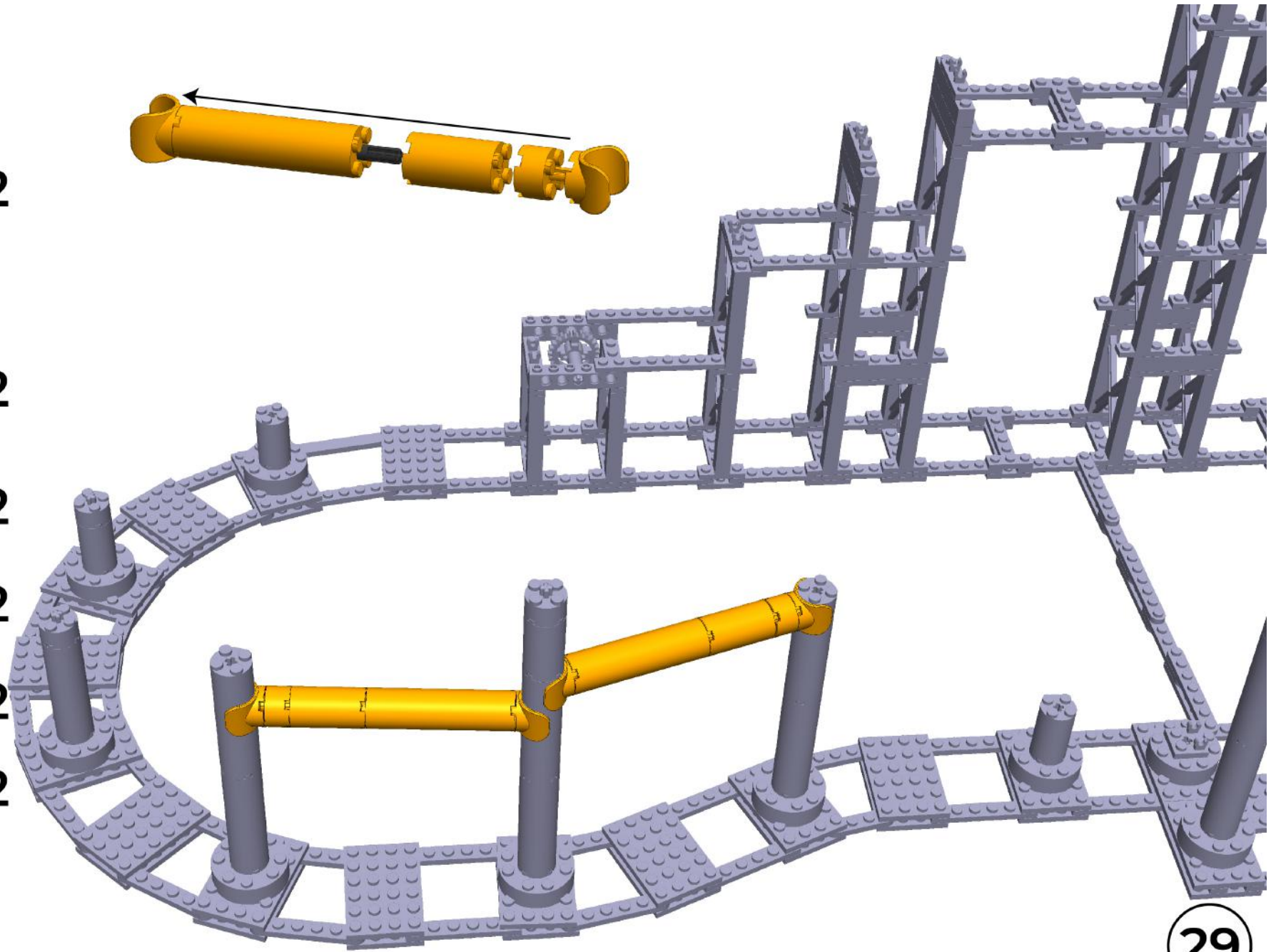
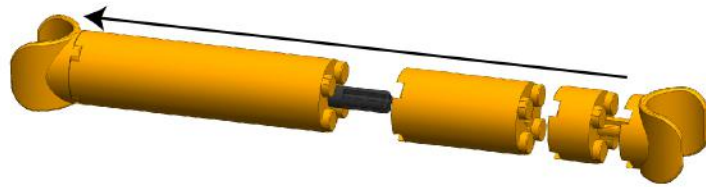



x7

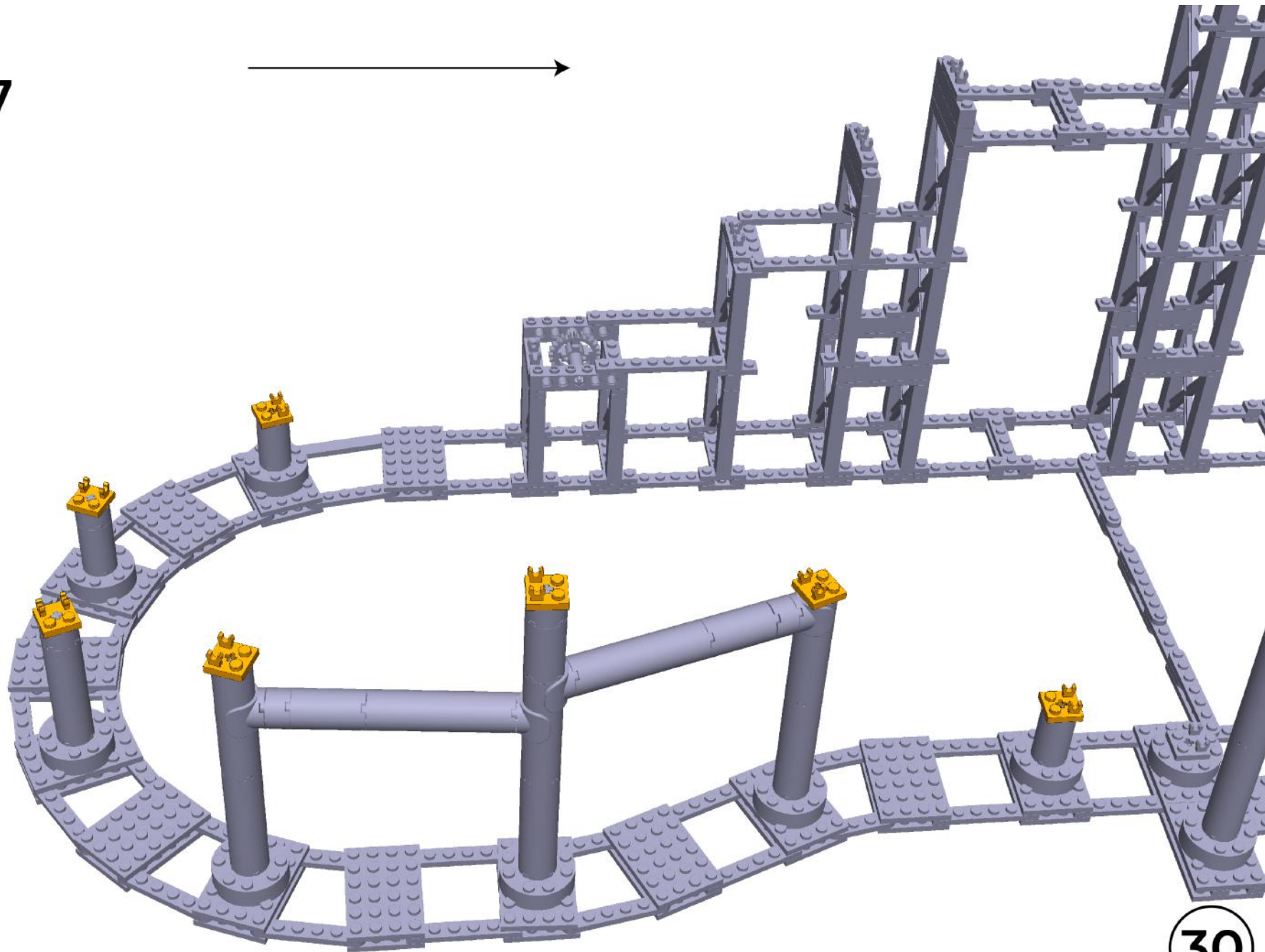



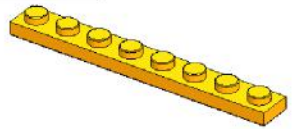

x3

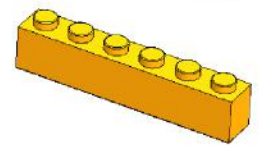

x1

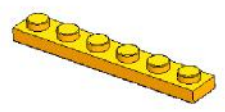

x3

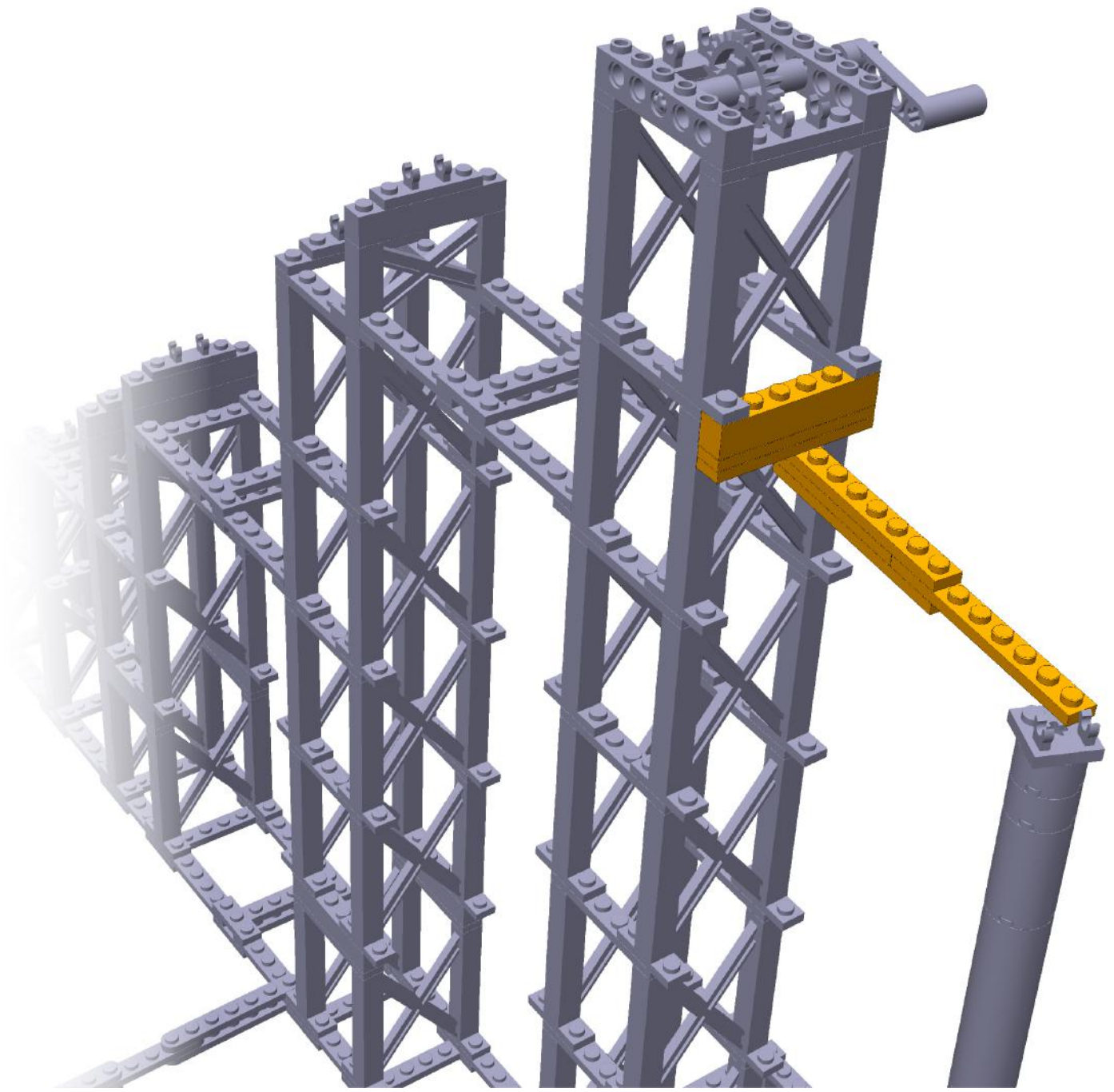



 x28

Do not place crosstie

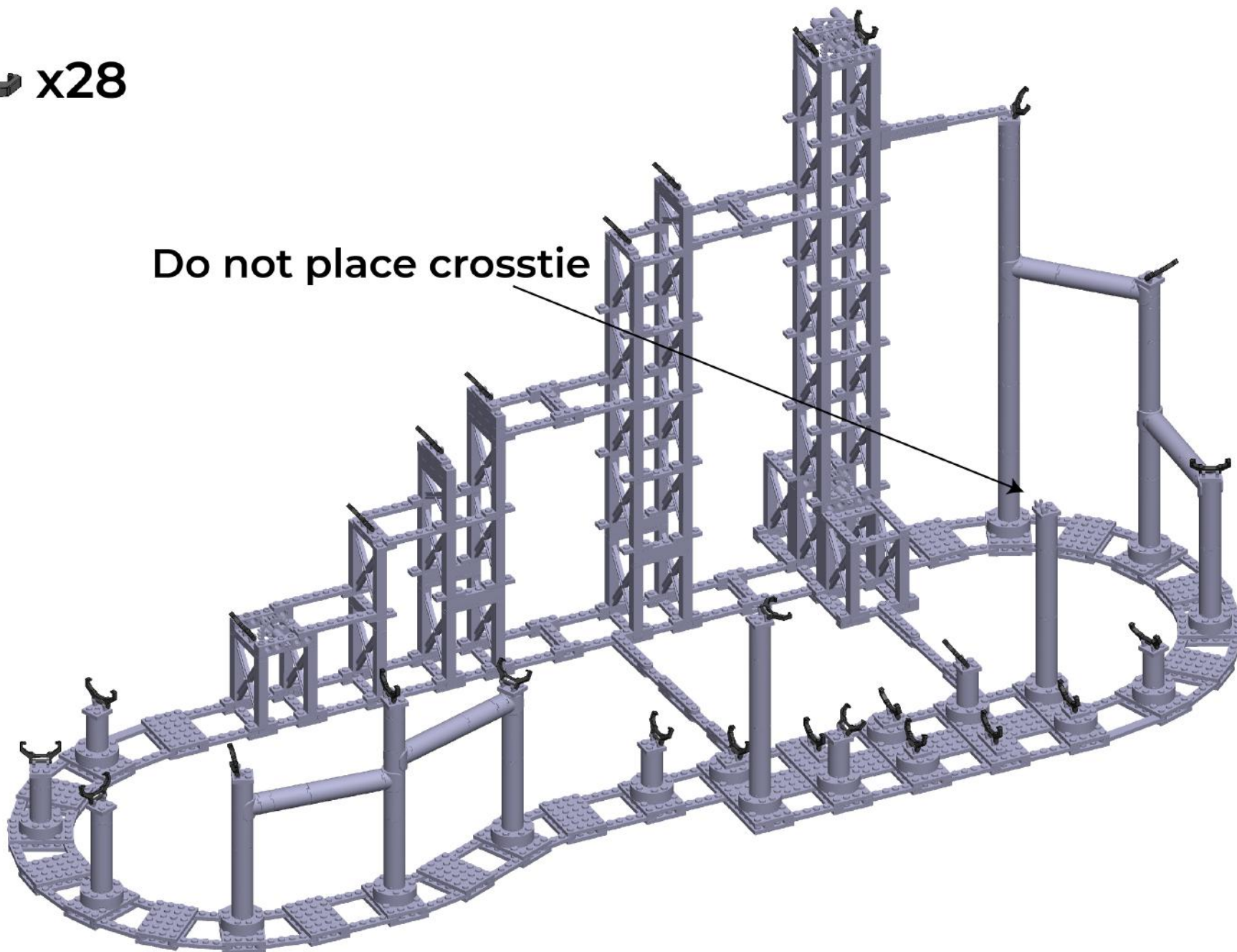

 x139

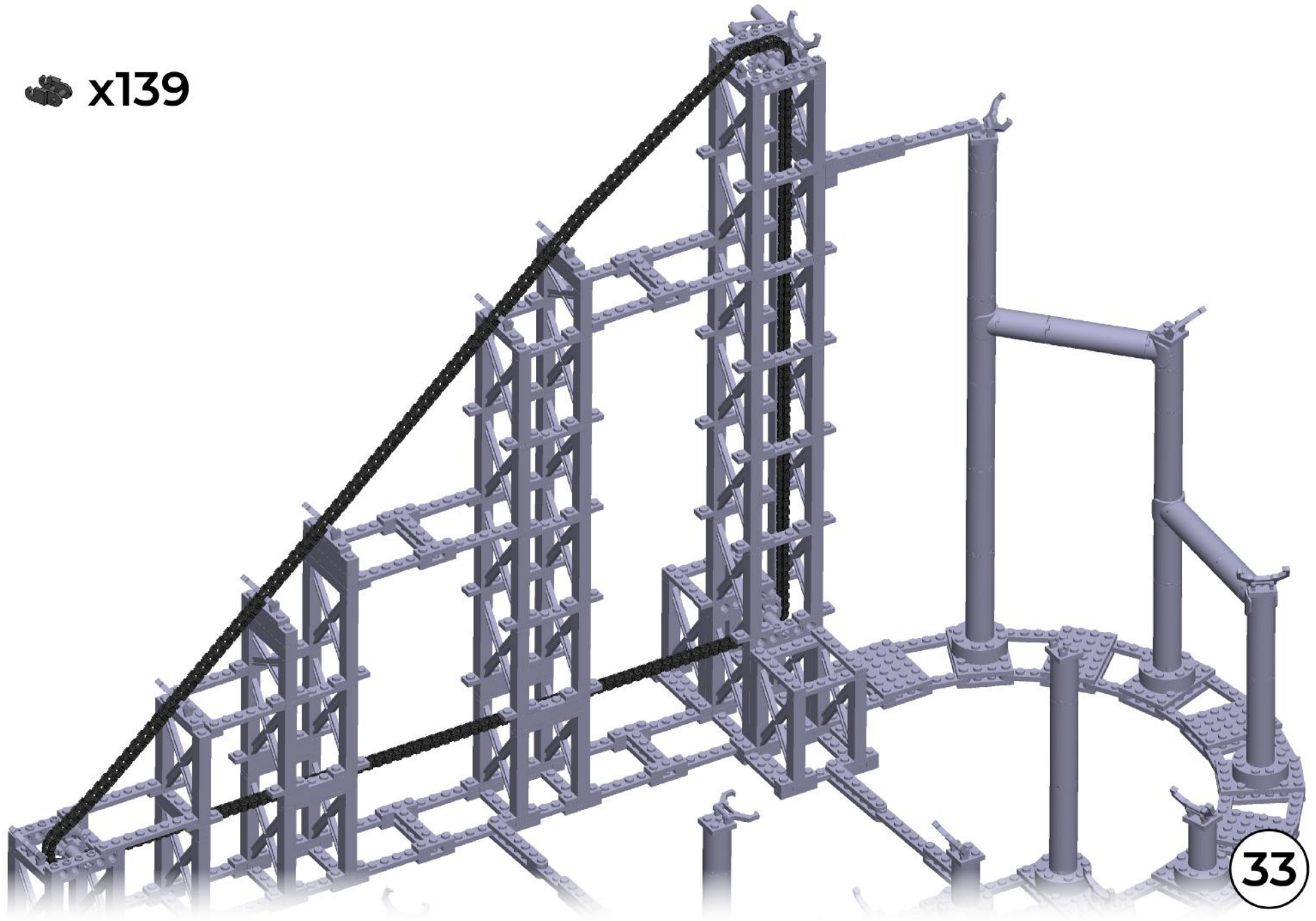



Snap rail to cross ties moving backwards through the layout

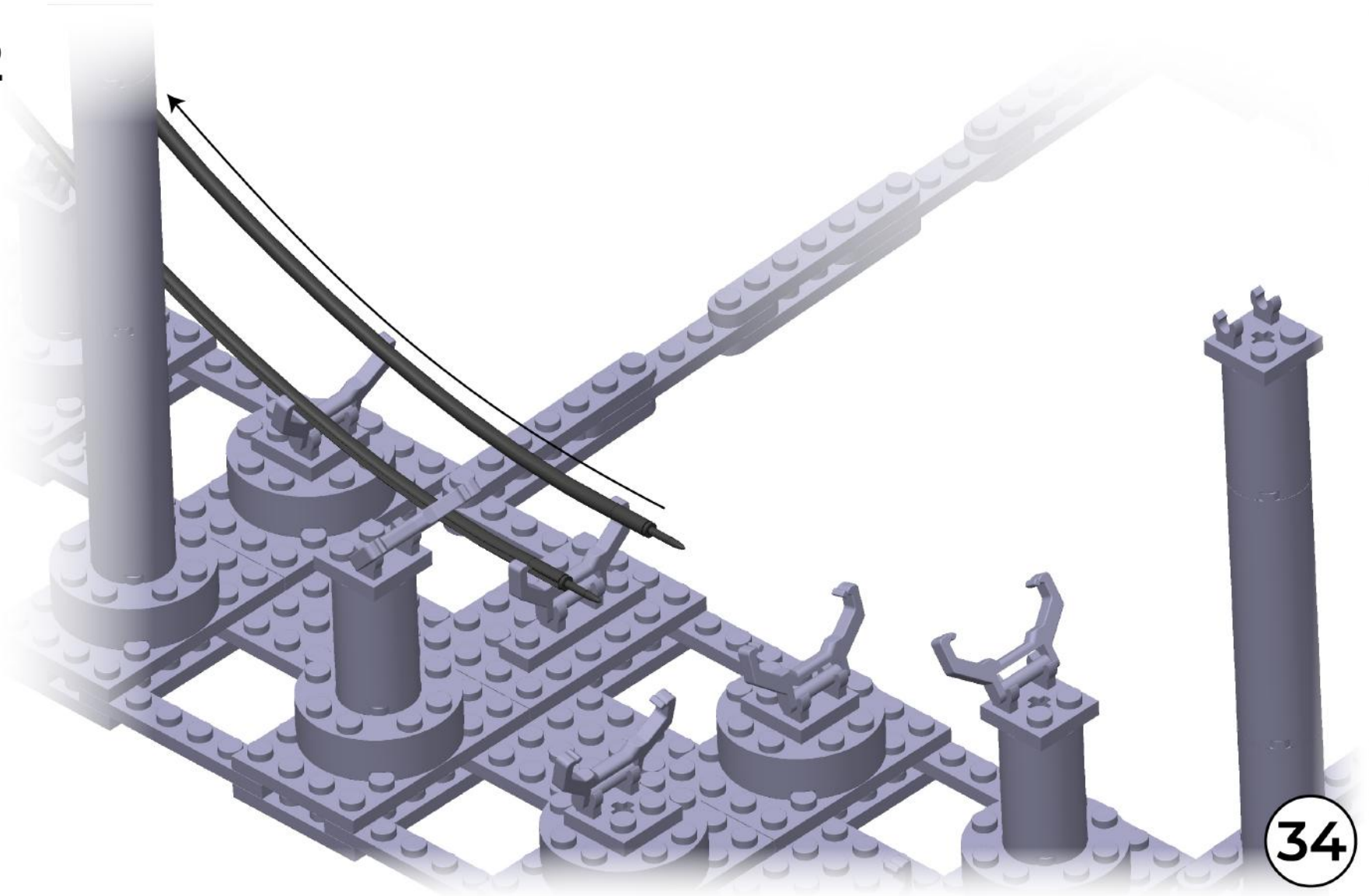



 x47

Keep excess rail  
for next step

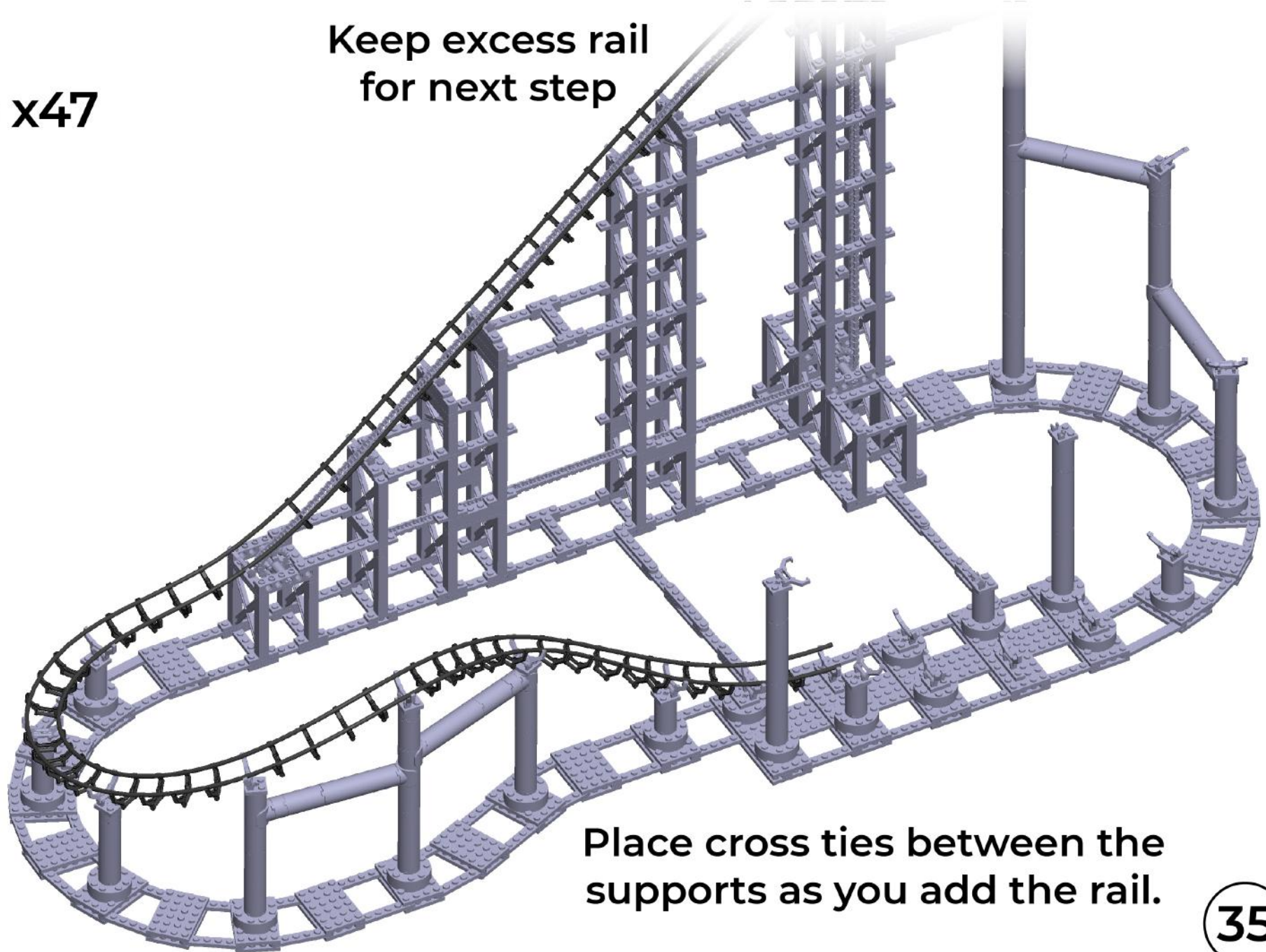

Place cross ties between the  
supports as you add the rail.



 x34

Keep excess rail  
for next step

Place cross ties between the  
supports as you add the rail.

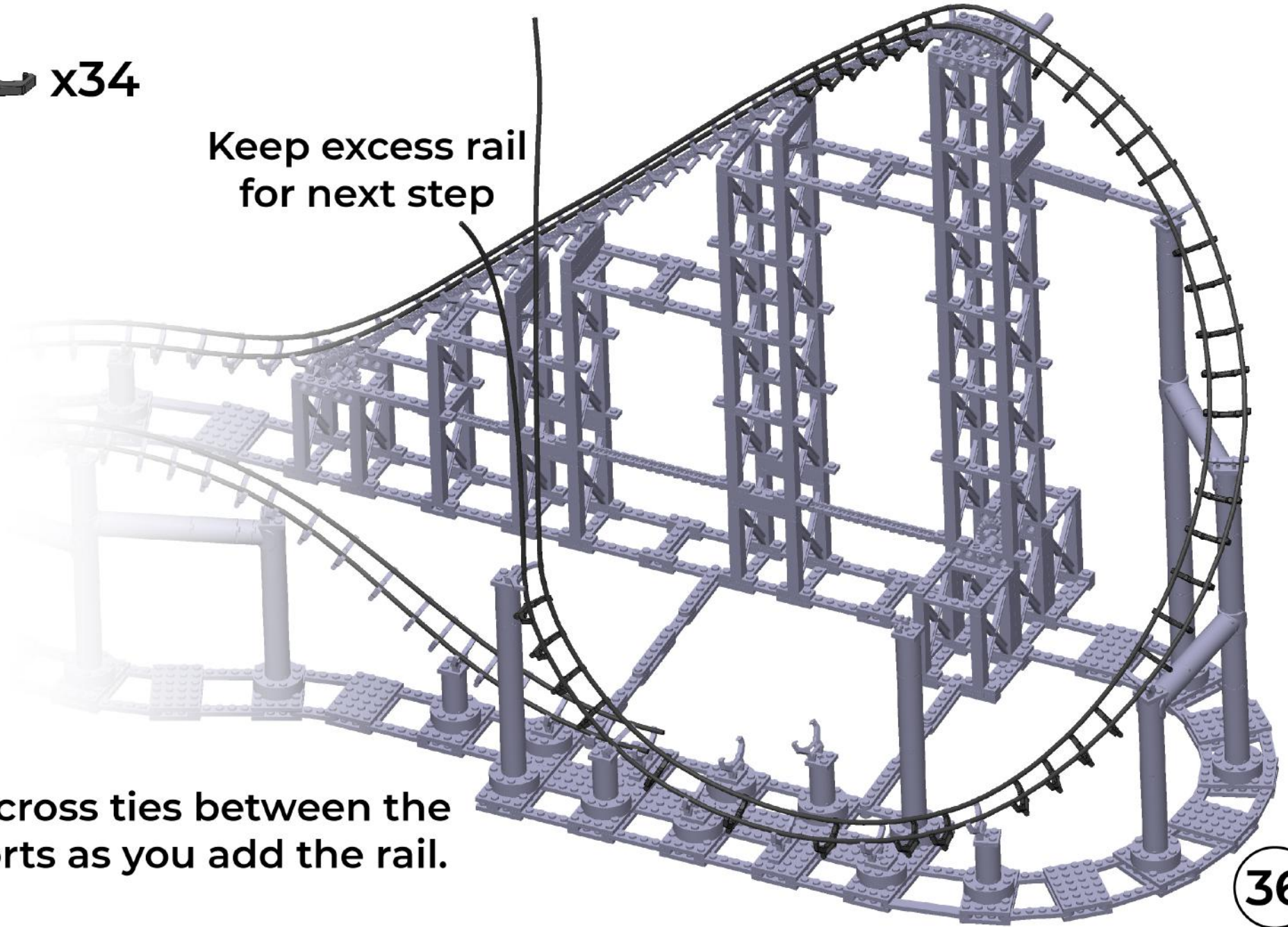



 x21

Keep excess rail  
for next step

14.5"  
37cm

Be sure track is  
straight and  
does not curve  
from side to  
side

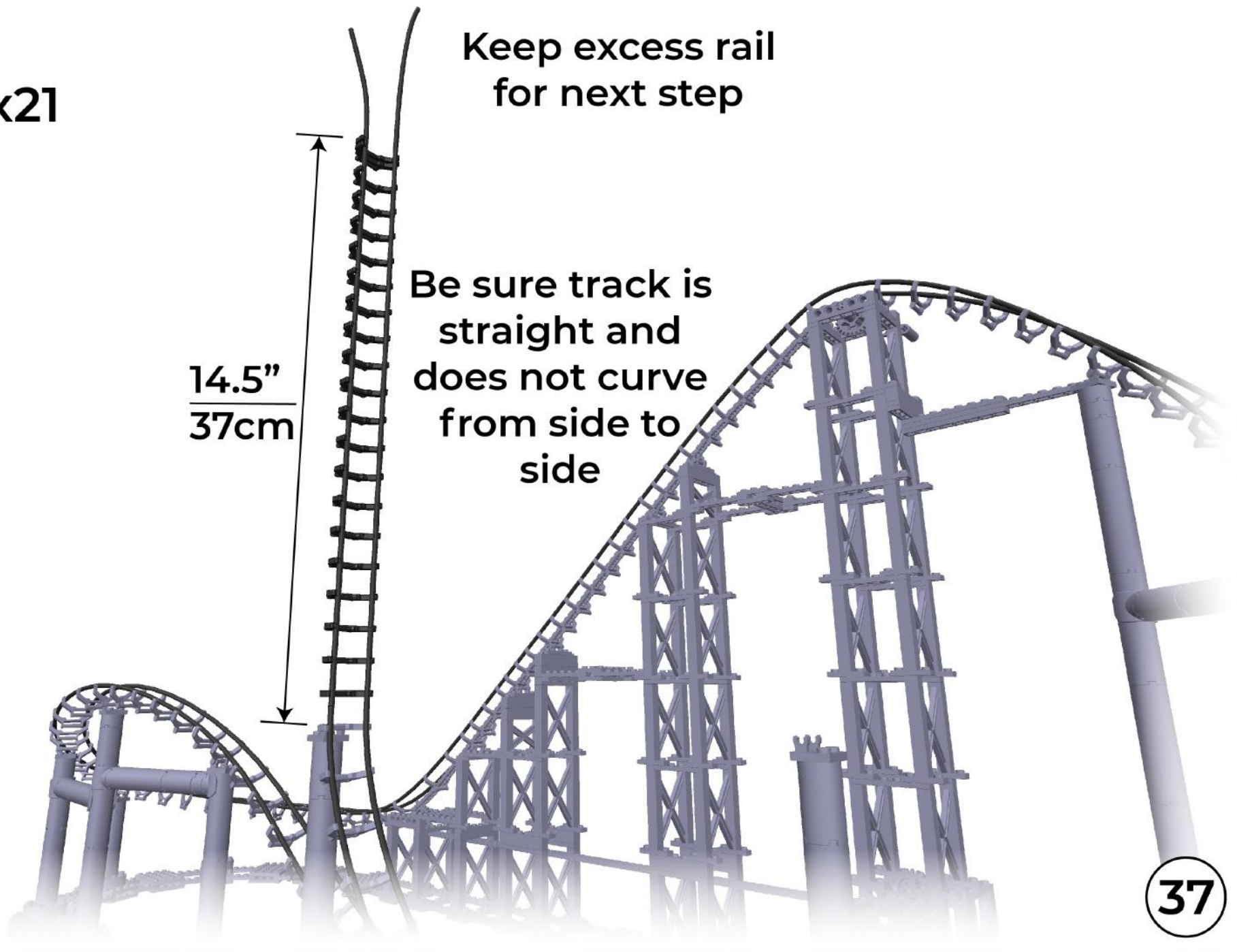

Carefully bend the track over and attach the last cross tie to the loop support.

**\*Hint\***

If the rail comes loose from the cross ties during this step, increase the number of crossties from 21 to 25 on the previous step.

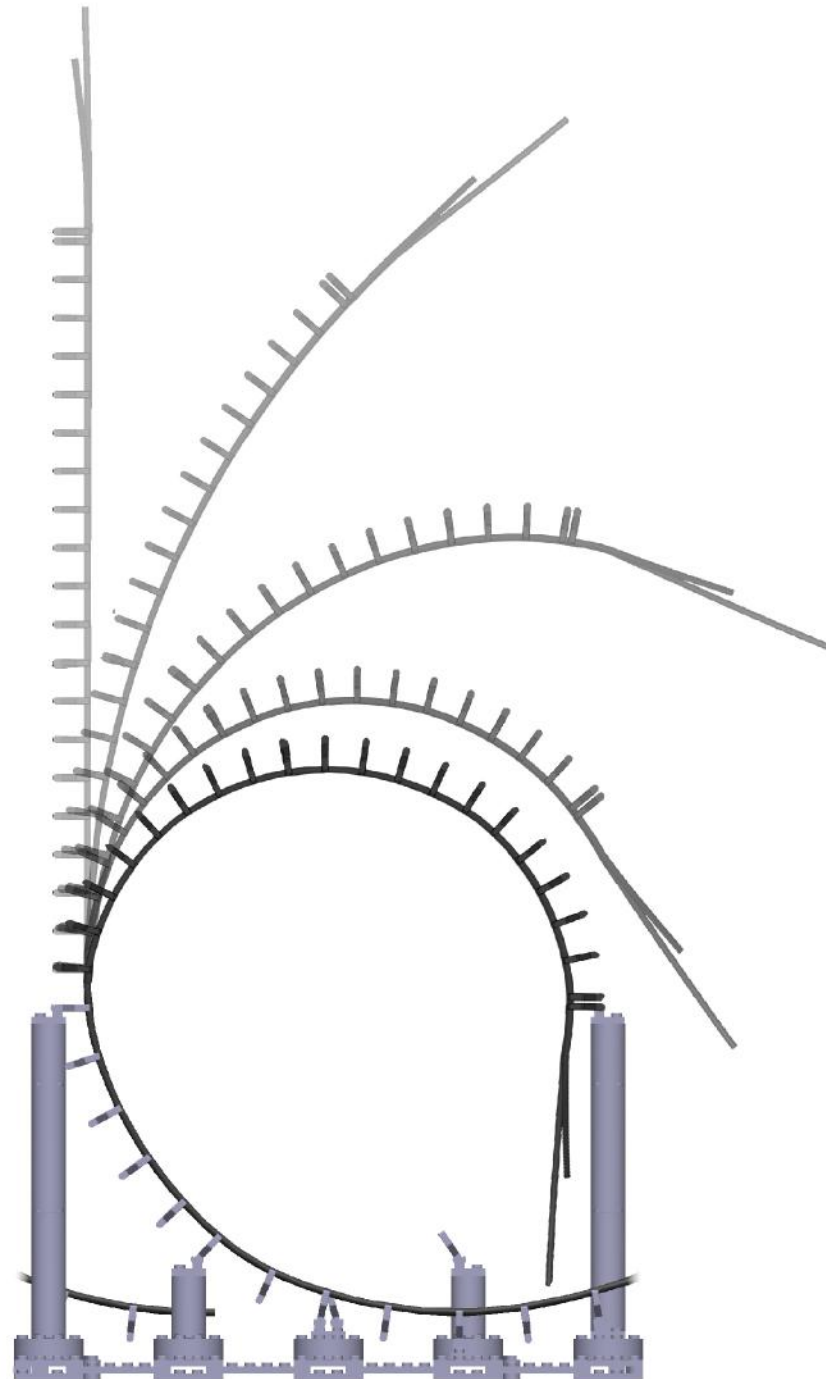





 x6

Cut extra rail and  
insert the ends into  
the rail pins



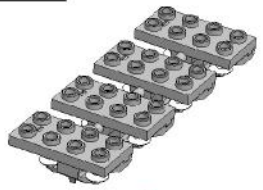

x1

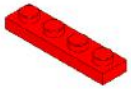

x1

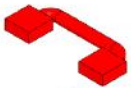

x3



x3



x2



x6

Push each train car onto the rail until the wheels "Snap" in

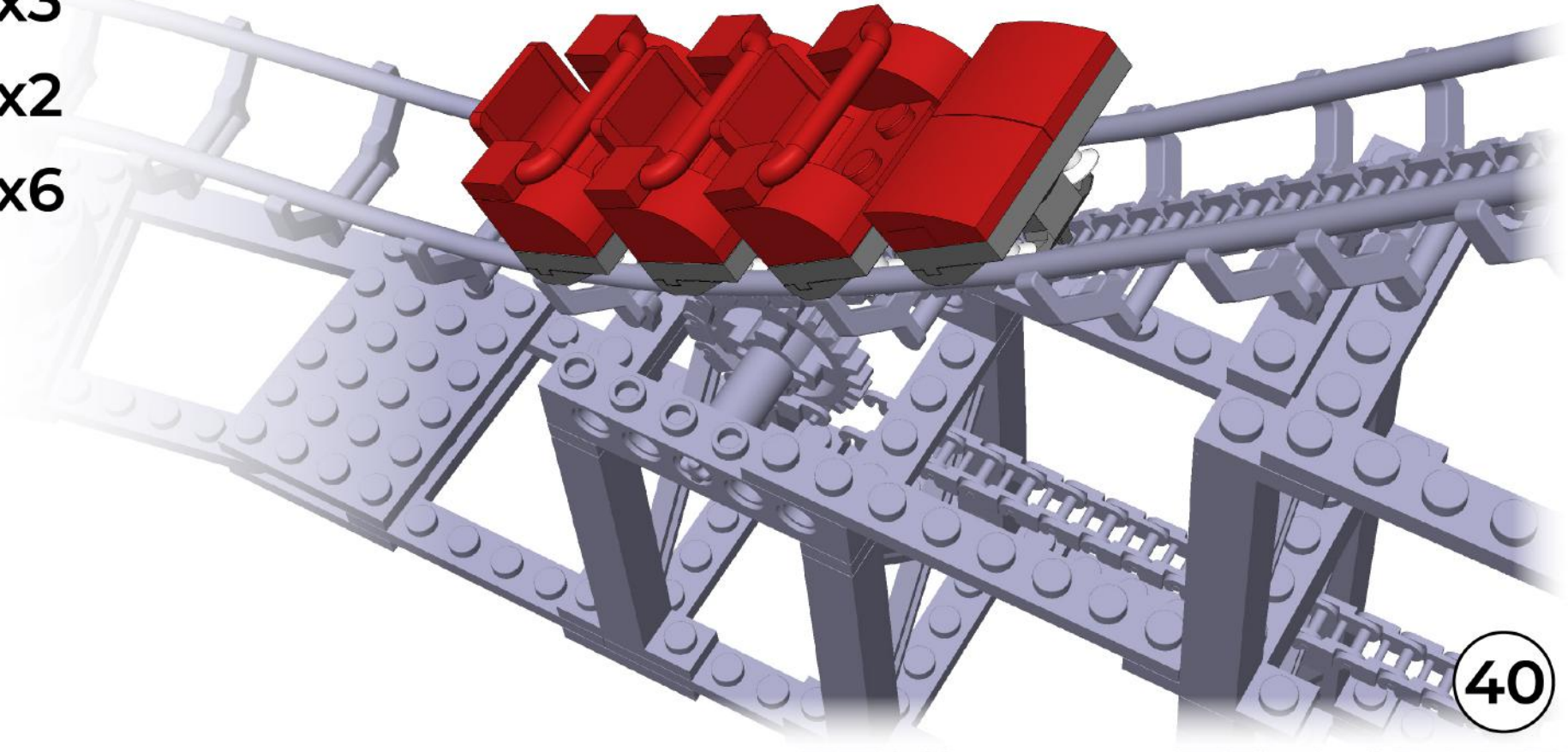



**Email questions or comments to:**

**[INFO@CDXBLOCKS.COM](mailto:INFO@CDXBLOCKS.COM)**

180 Shen-Elk Plaza  
Elkton, Virginia, 22827

**[WWW.CDXBLOCKS.COM](http://WWW.CDXBLOCKS.COM)**

©2018 CDXBLOCKS/COASTERDYNAMIX