

x70

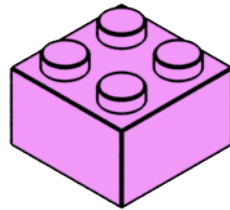

x22

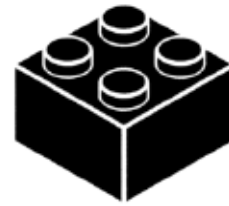

x3



1.

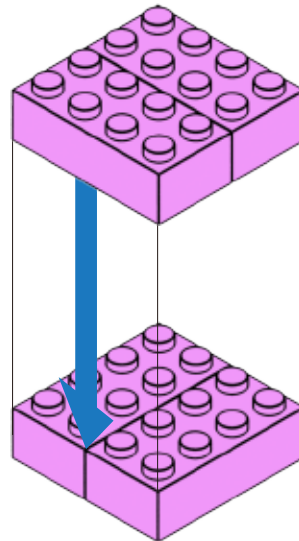
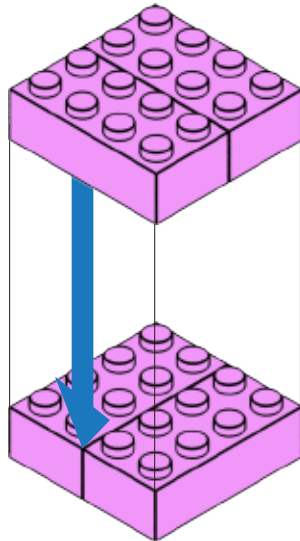
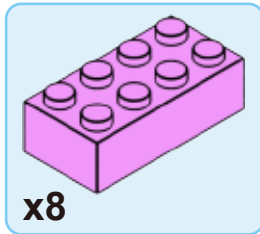

2.

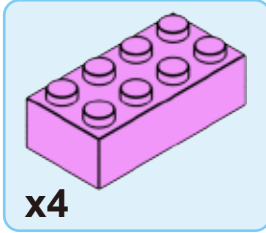

L

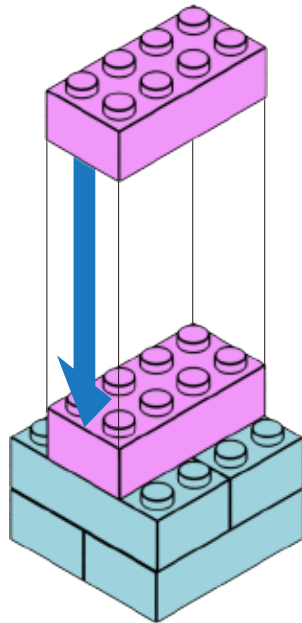

R

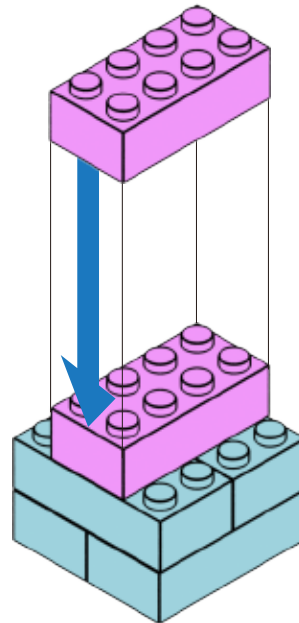

3.

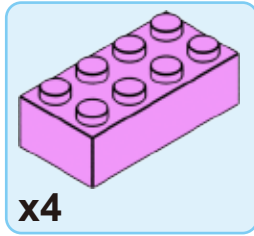

L

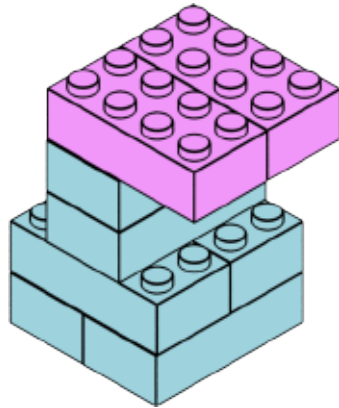

R

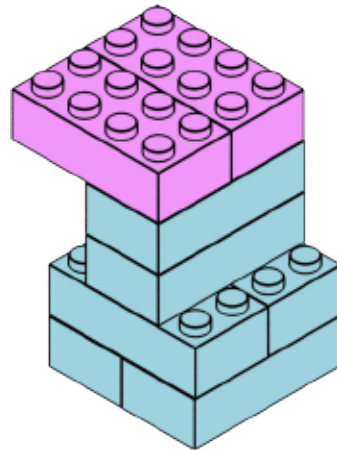

4.

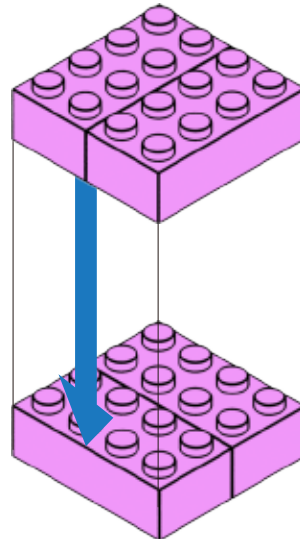
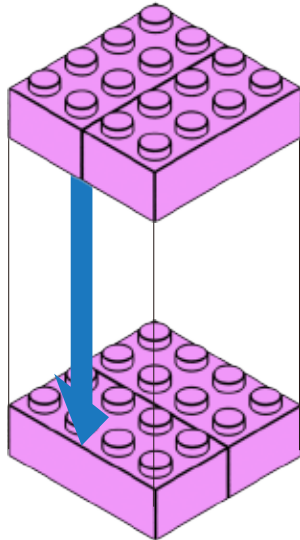
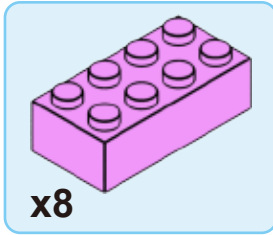

5.

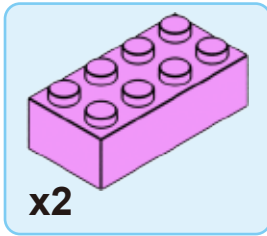
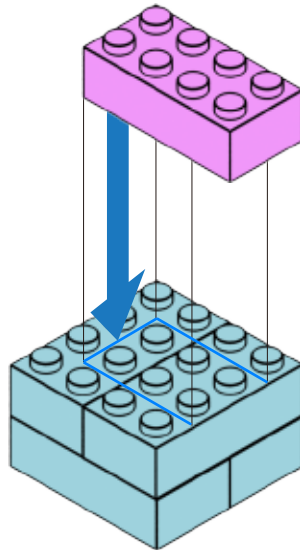
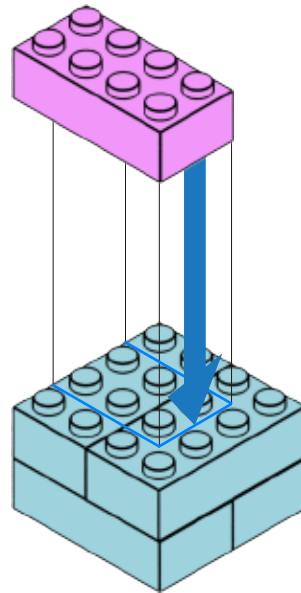
 L R

6.

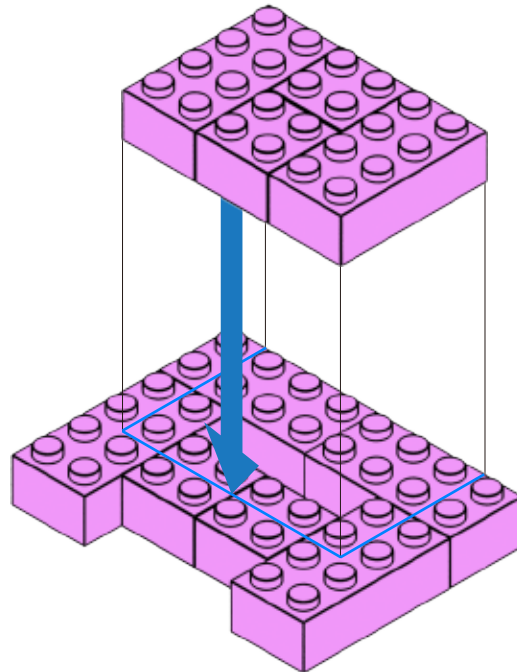
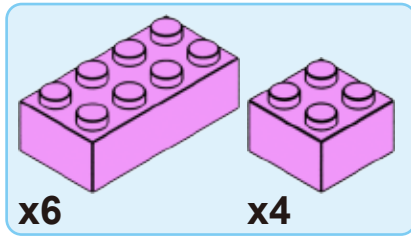

7.

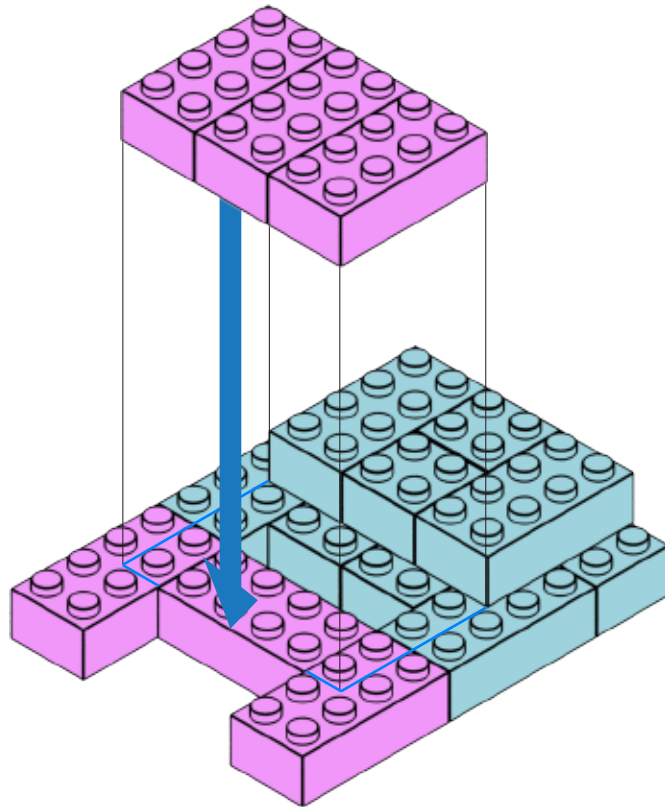
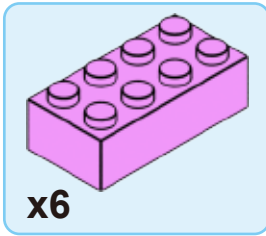

8.

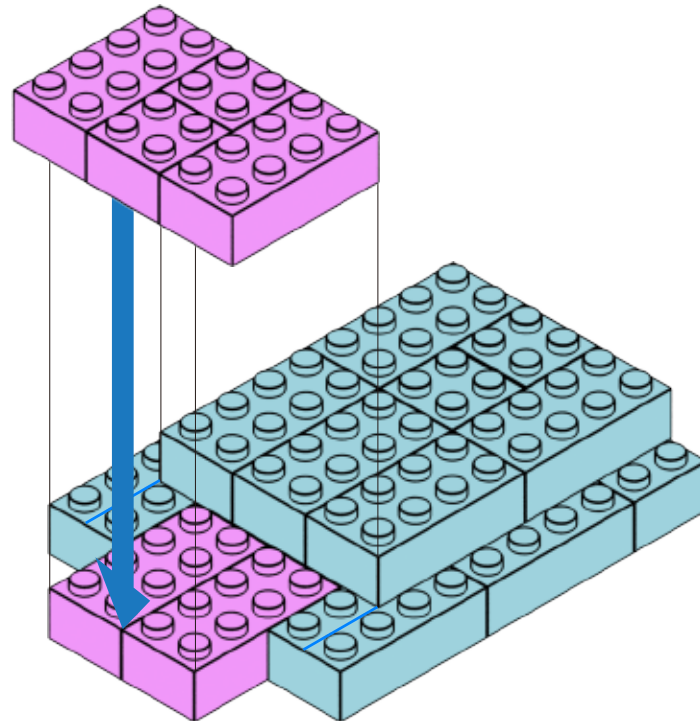
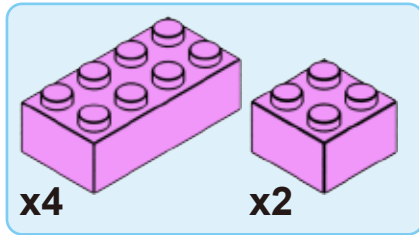

9.

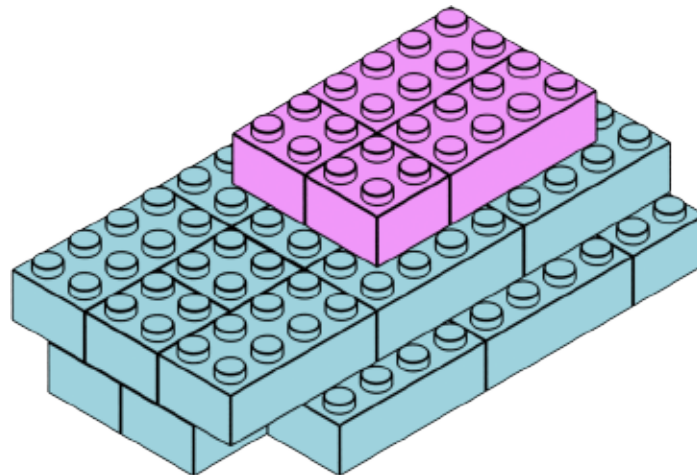
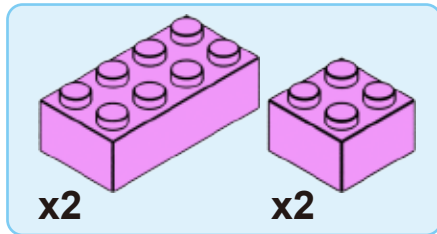

10.

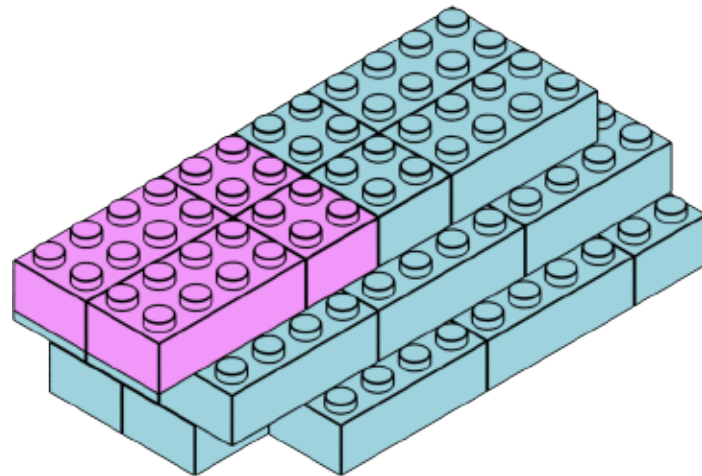
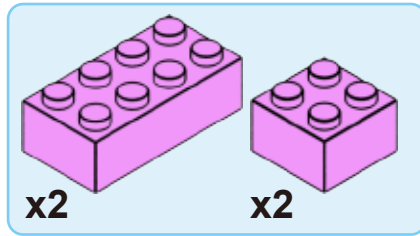

11.

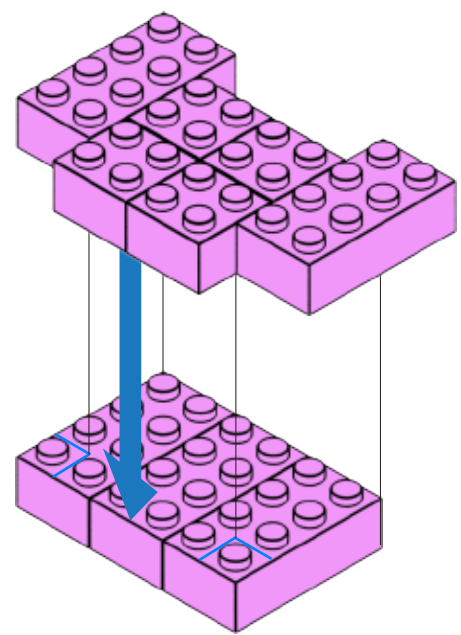
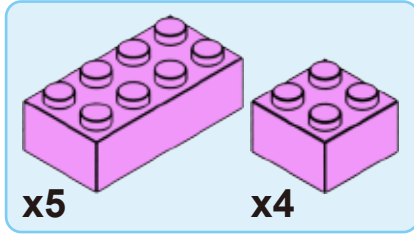

12.

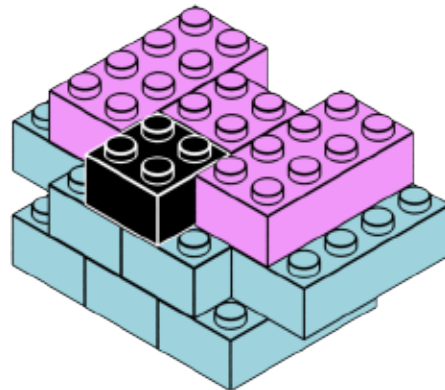
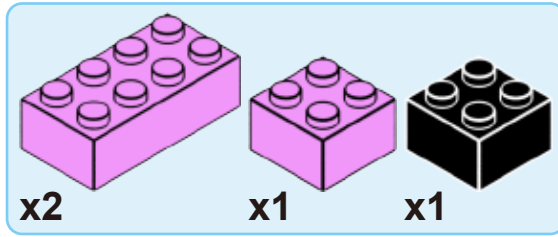

13.

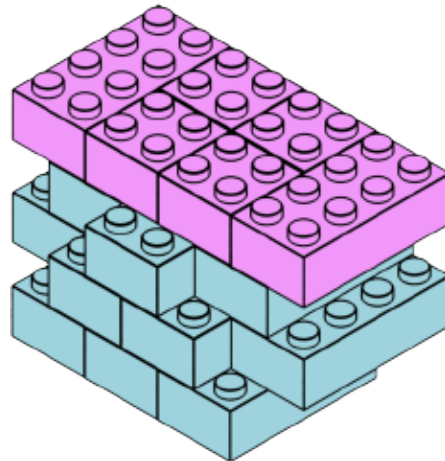
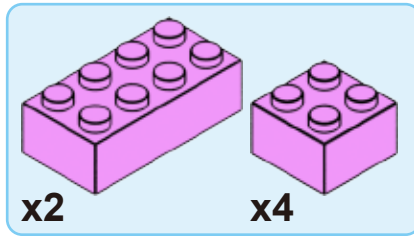

14.

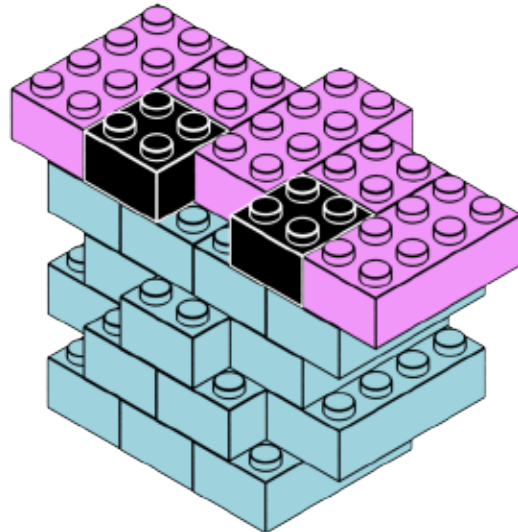
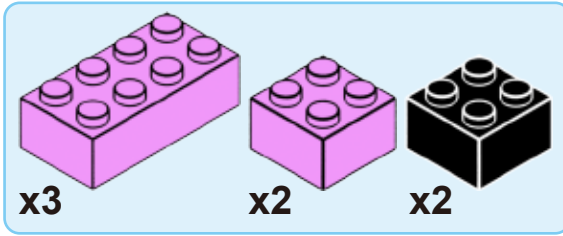

15.

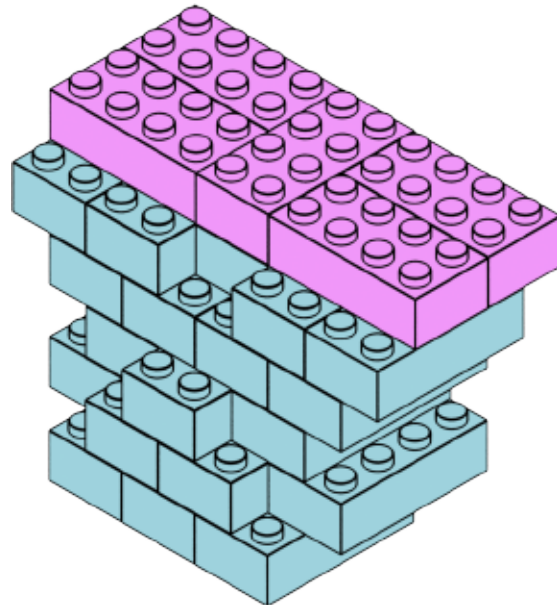
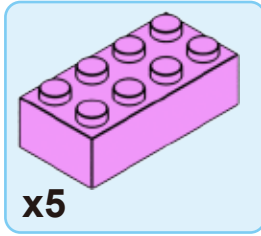

16.

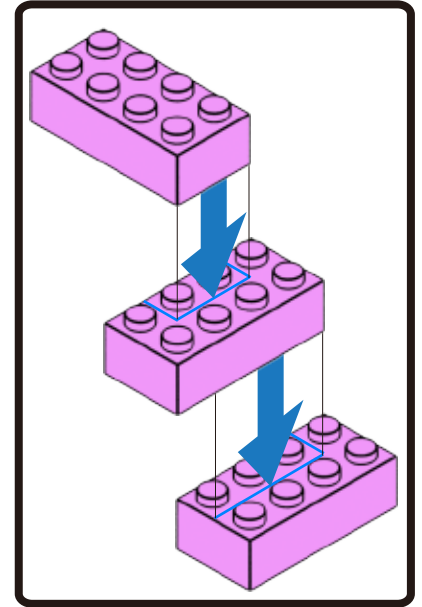
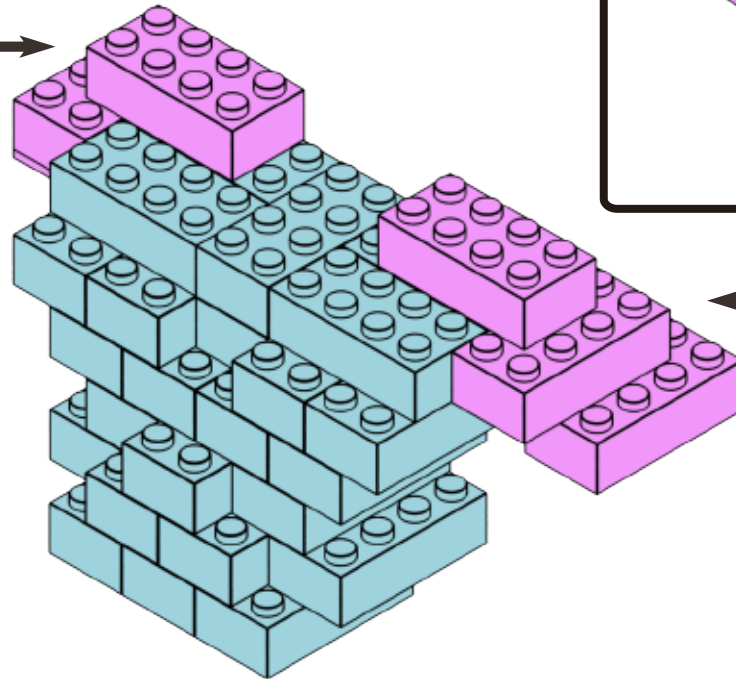
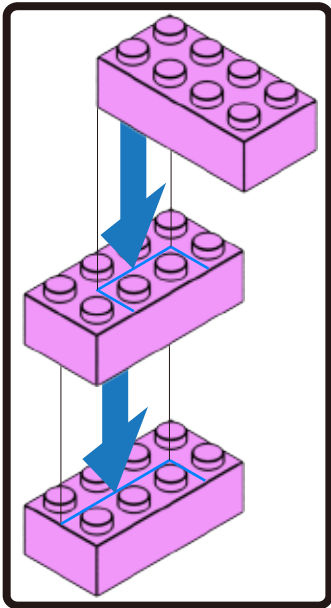
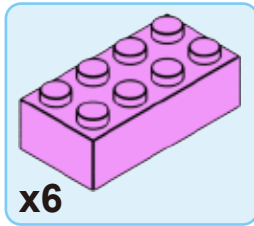

17.

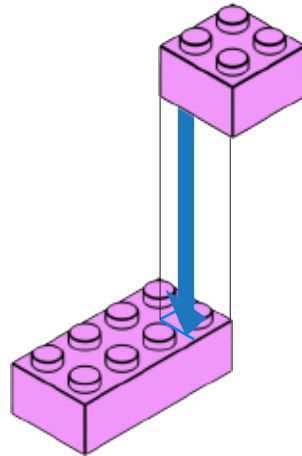
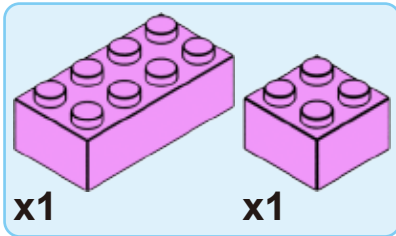

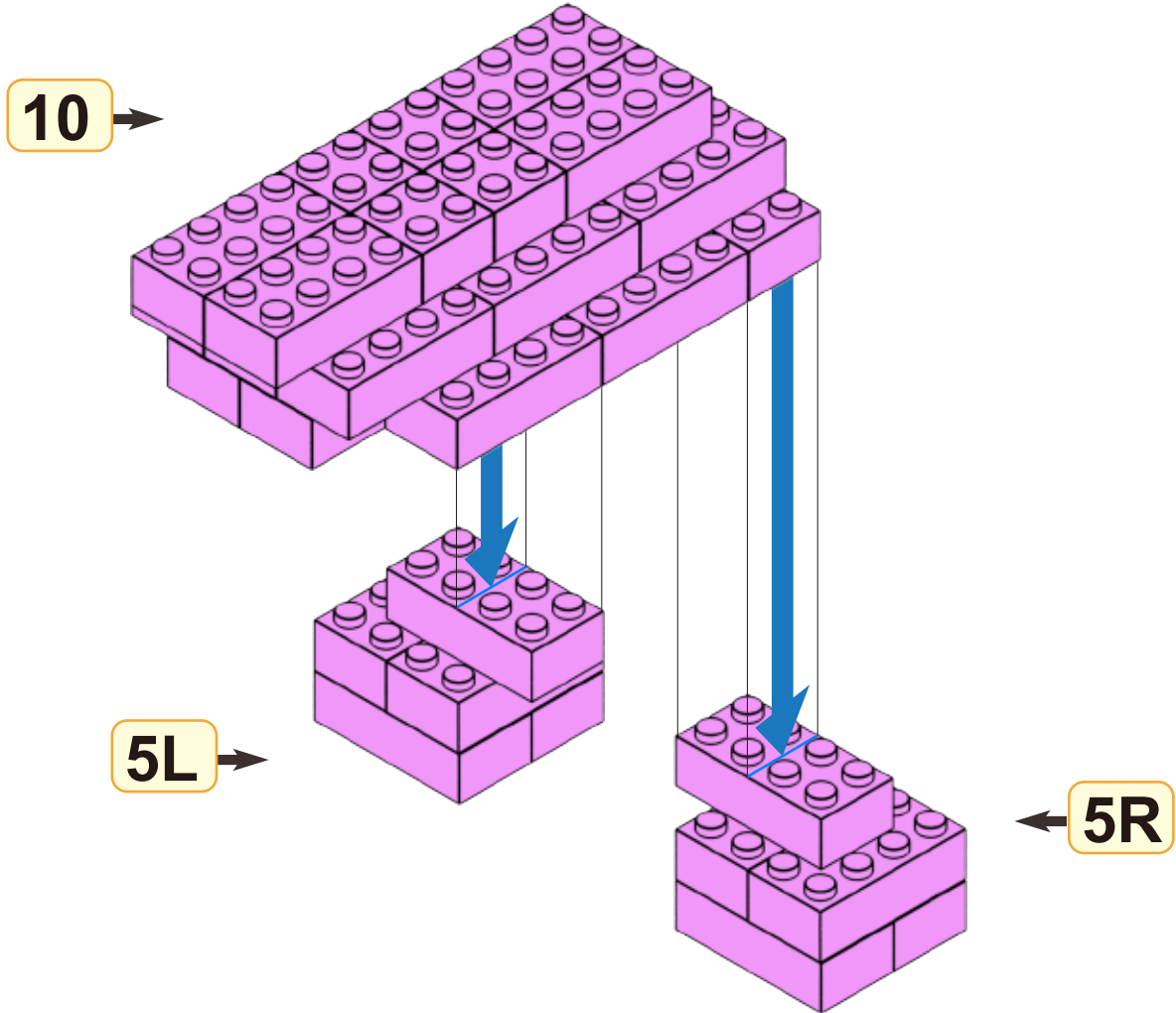

NEW

3L →

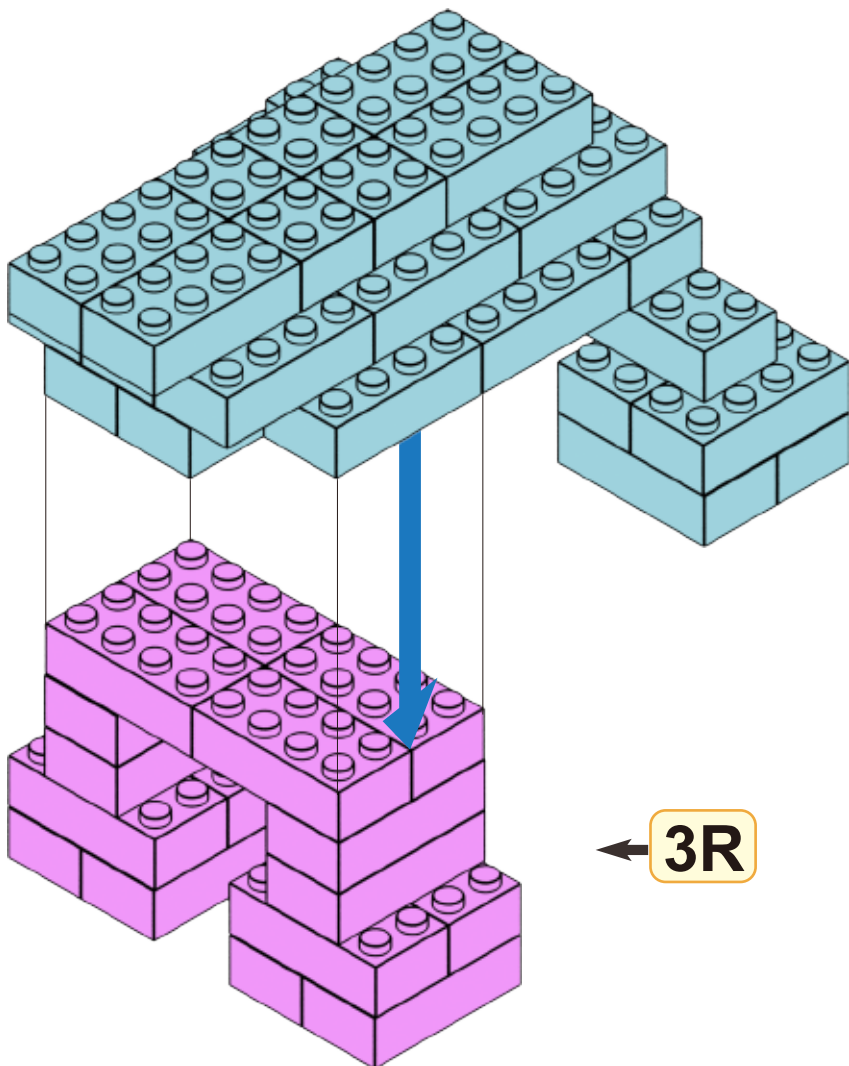

← **3R**

17 →

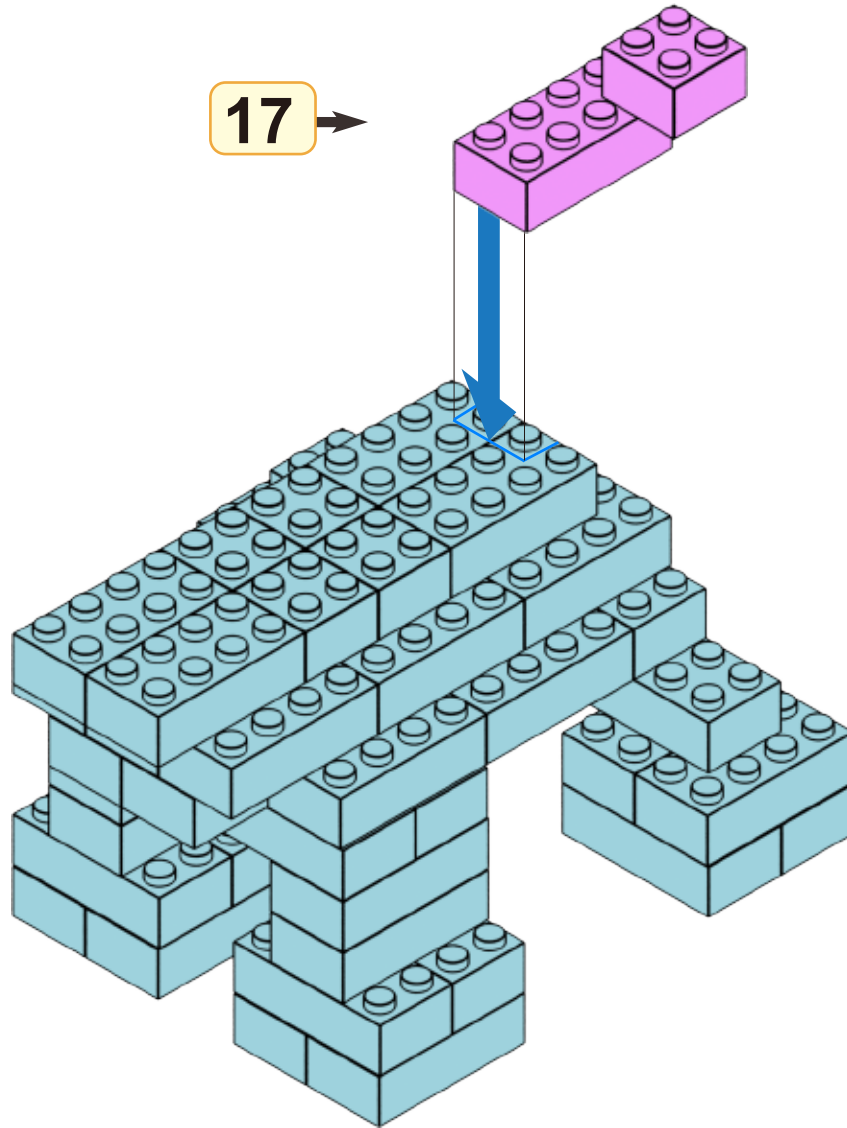

NEW

16 →

