

x54

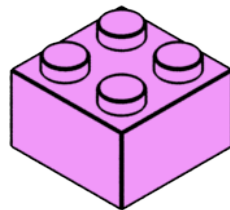

x28

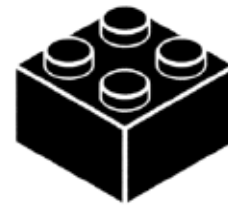

x3



1.

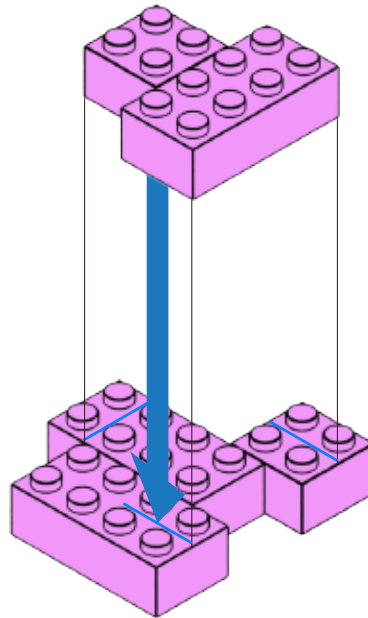
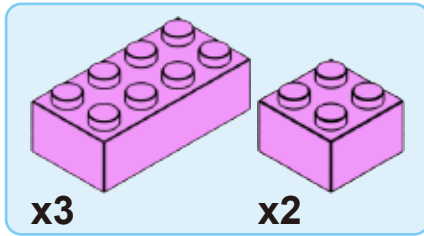

2.

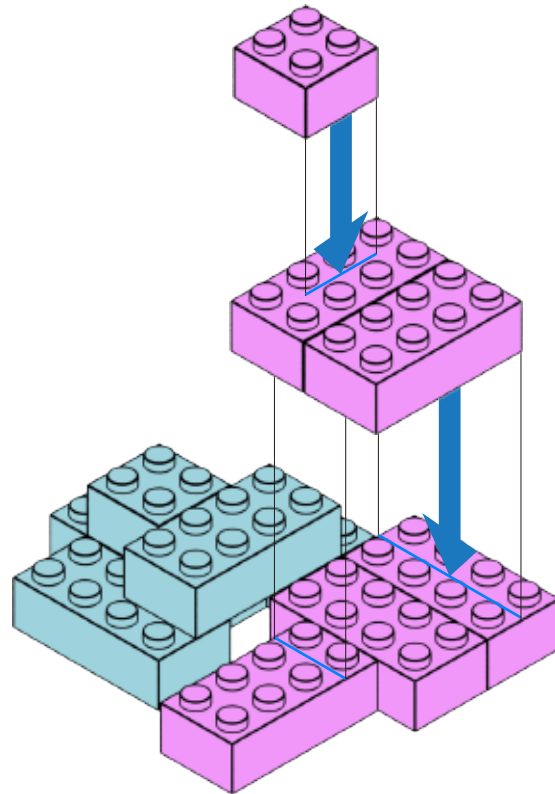
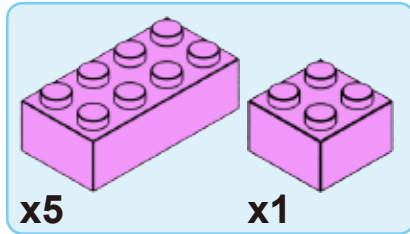

3.

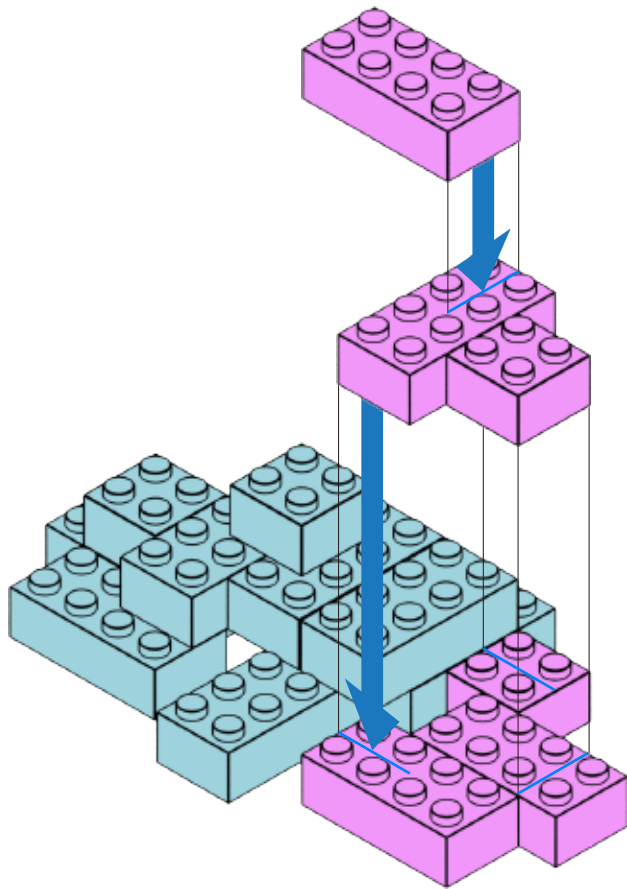
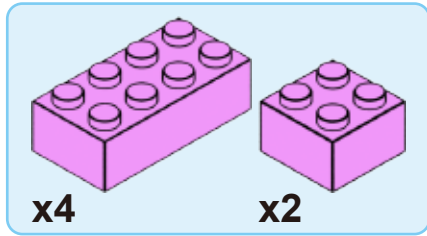

4.

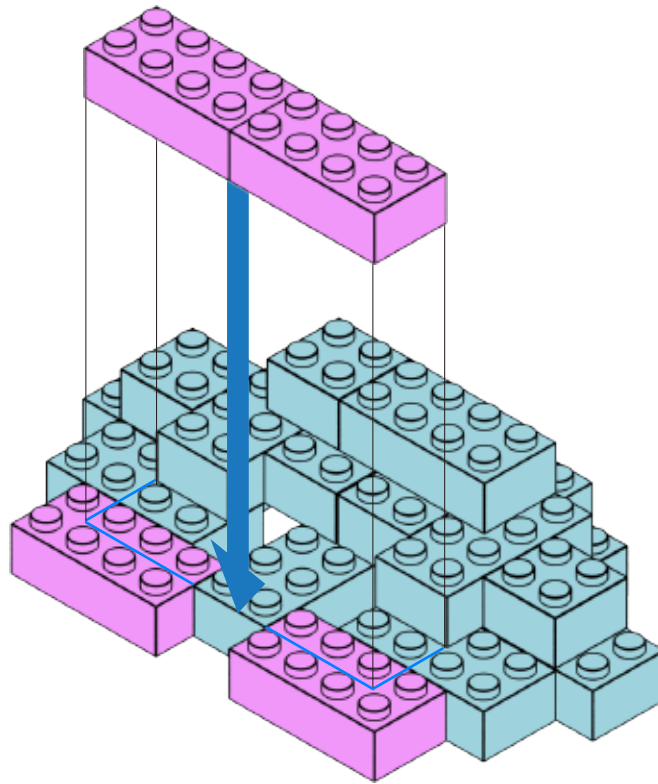
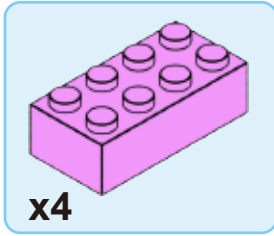

5.

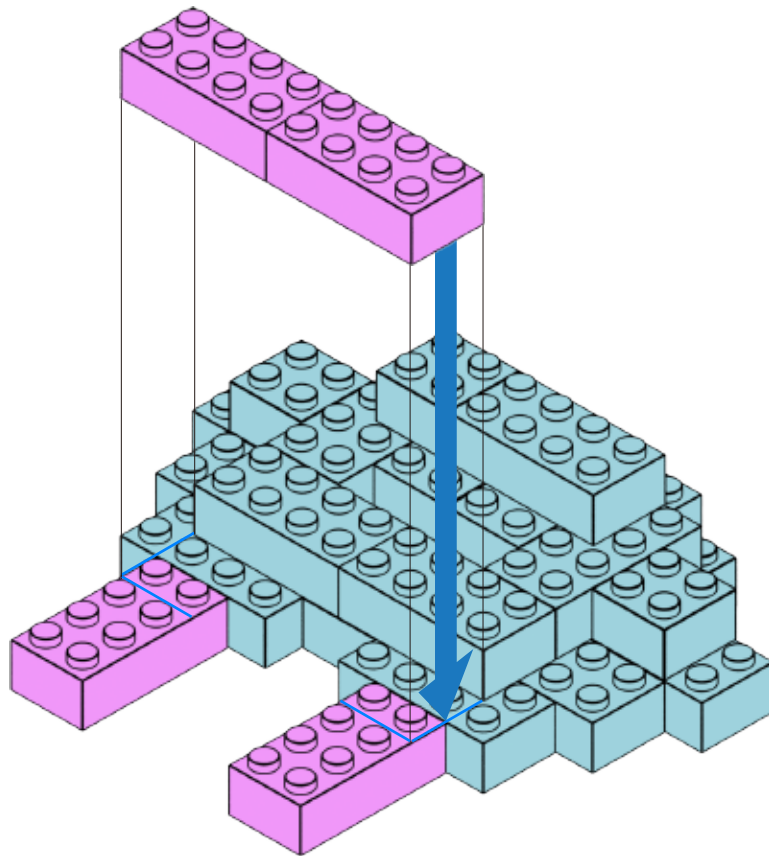
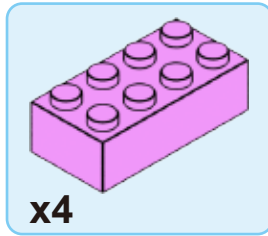

6.

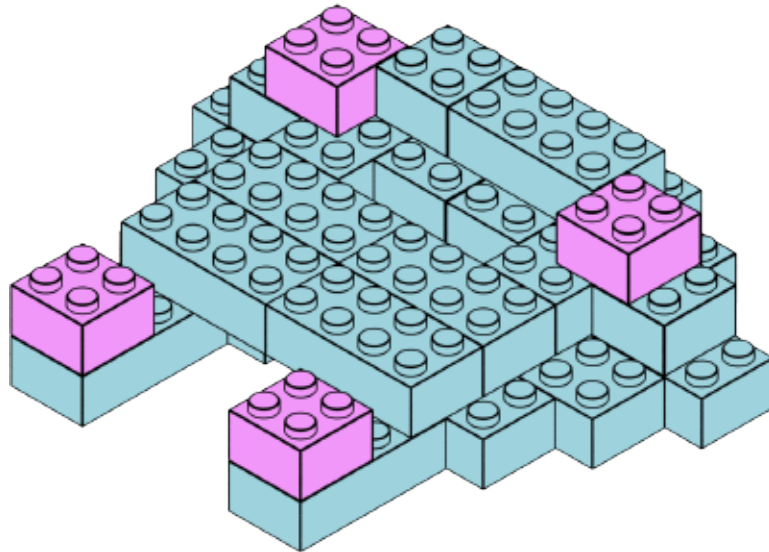
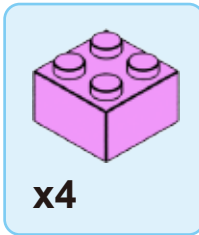

7.

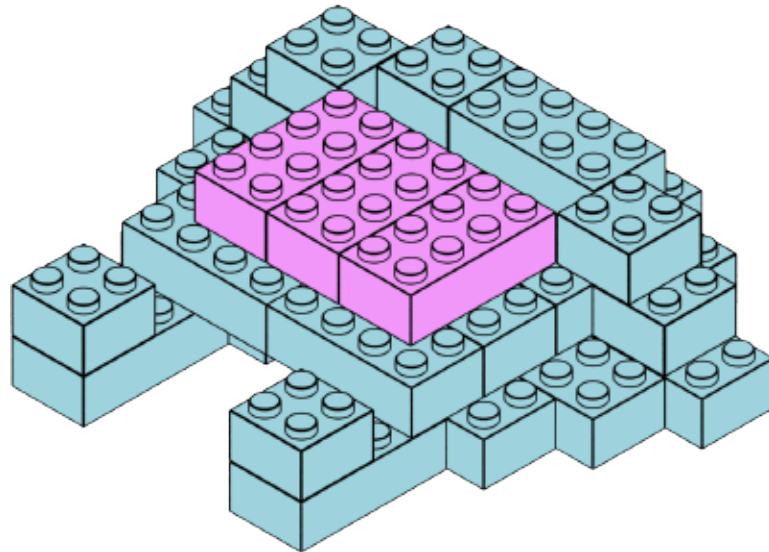
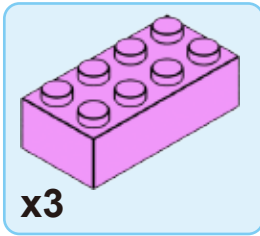

8.

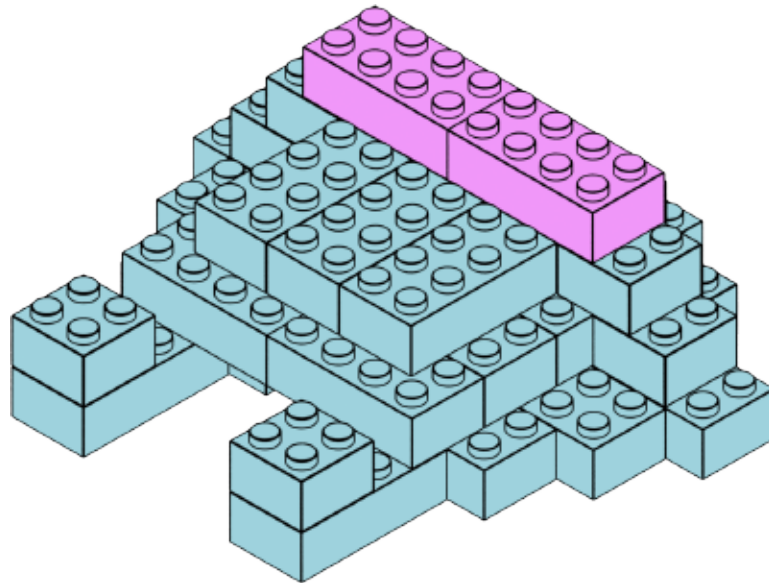
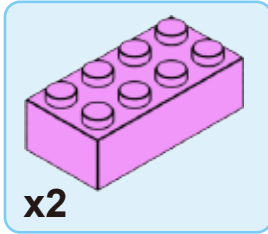

9.

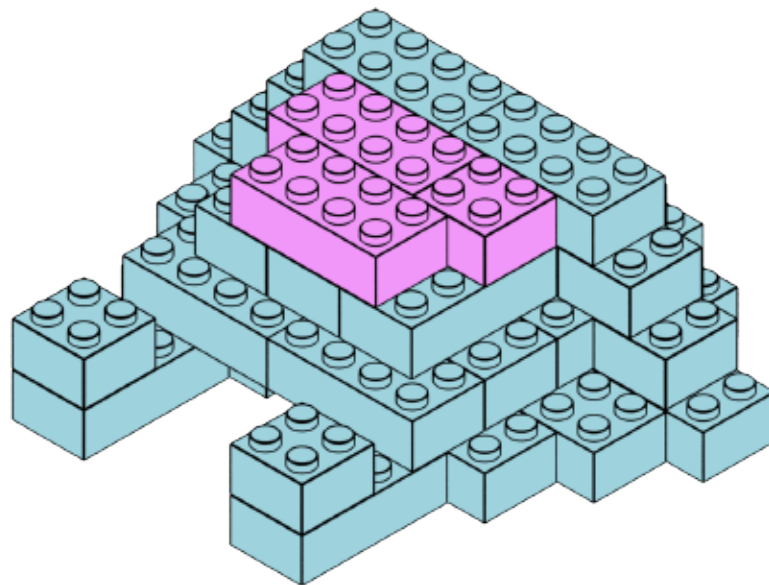
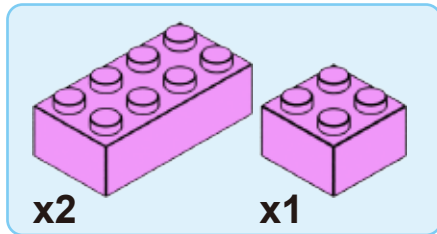

10.

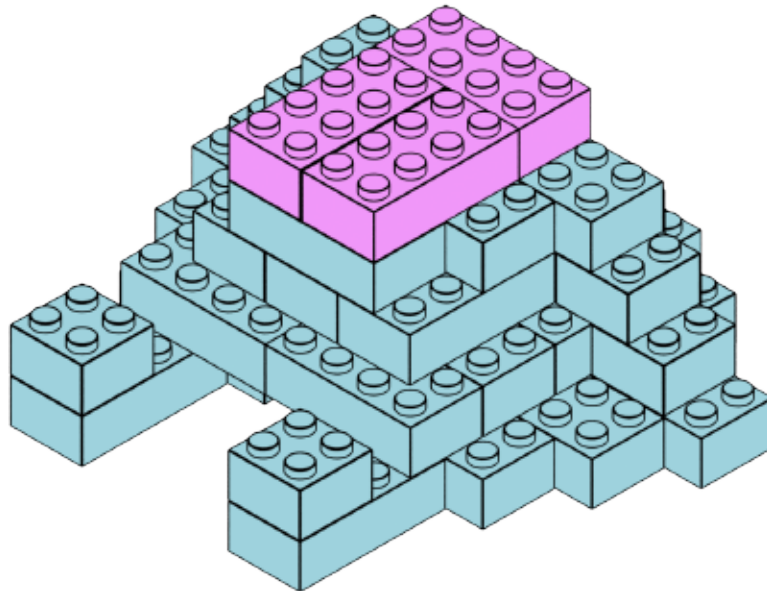
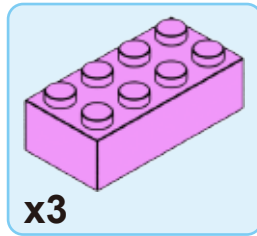

11.

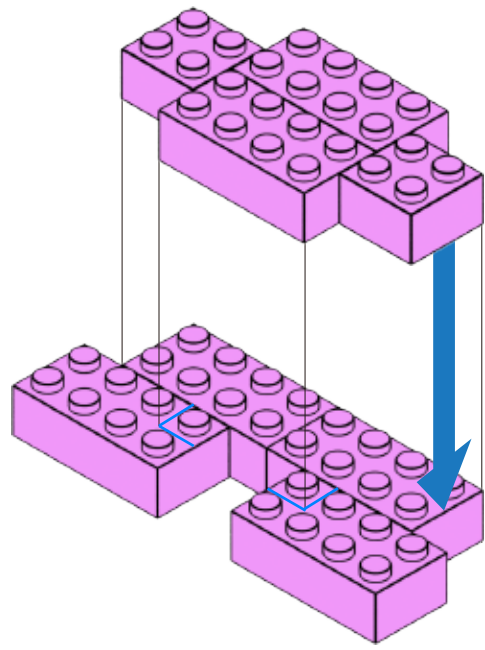
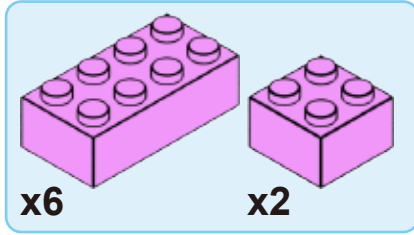

12.

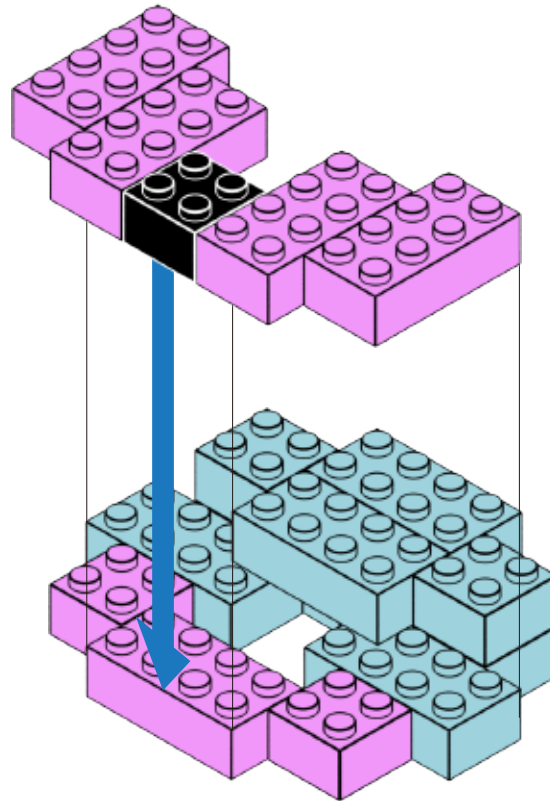
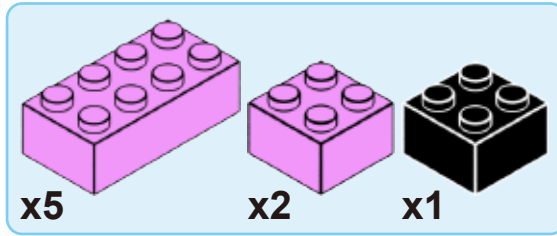

13.

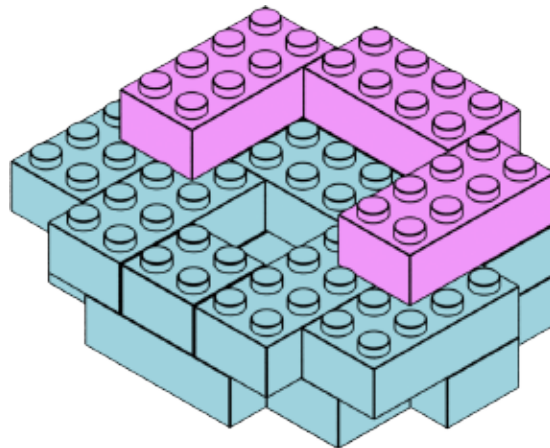
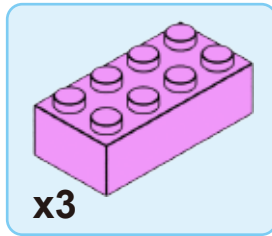

14.

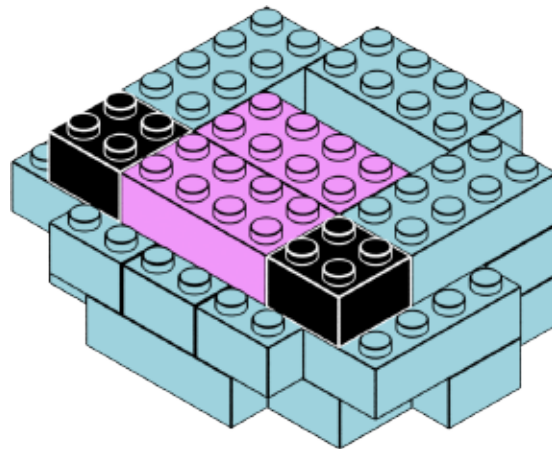
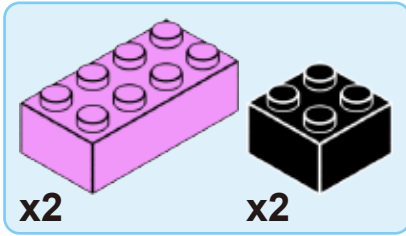

15.

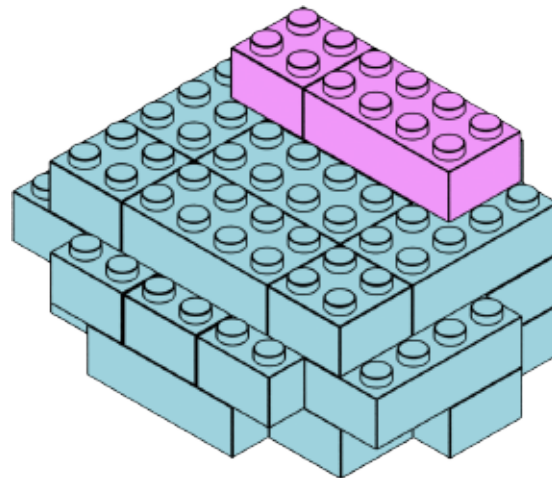
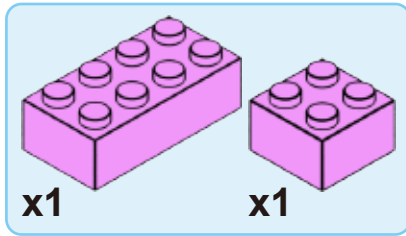

16.

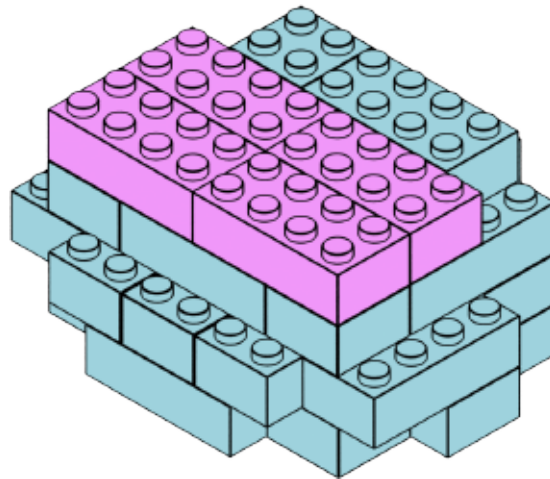
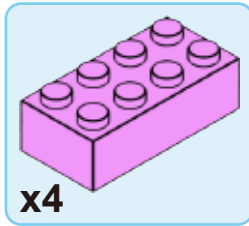

17.

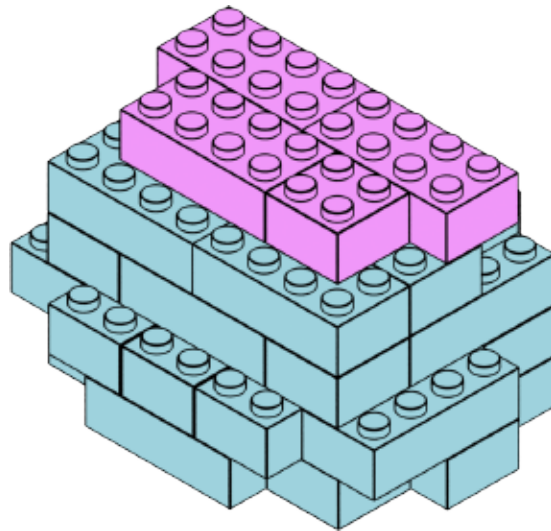
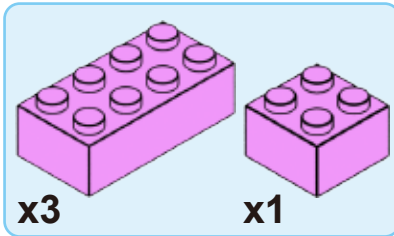

18.

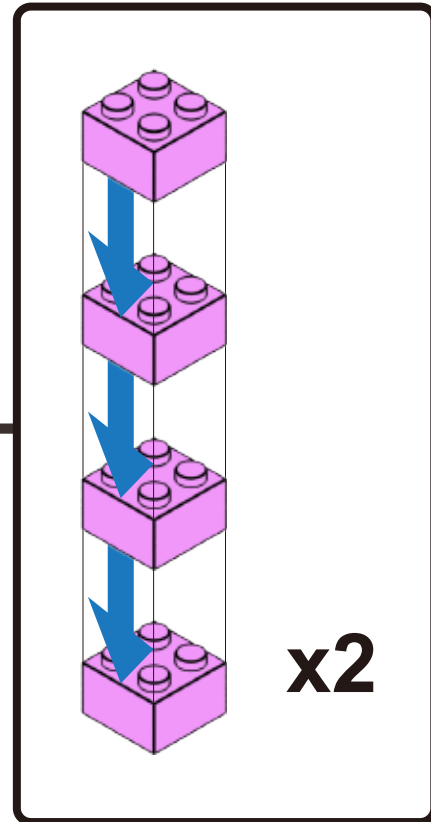
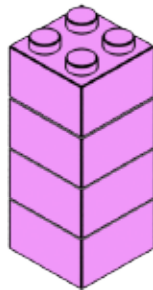
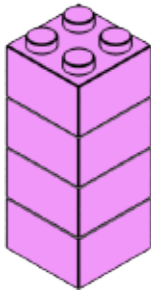
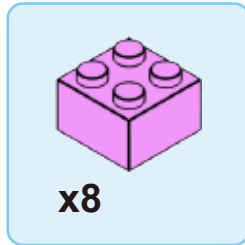

19.

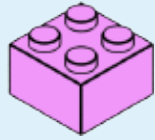

x4

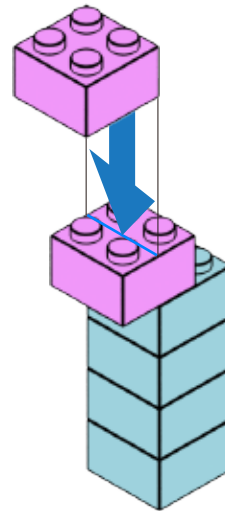
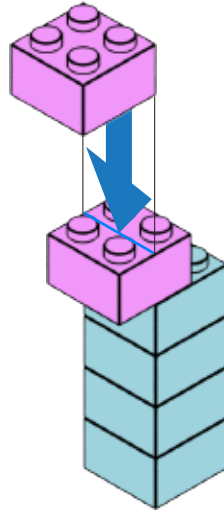

19 →

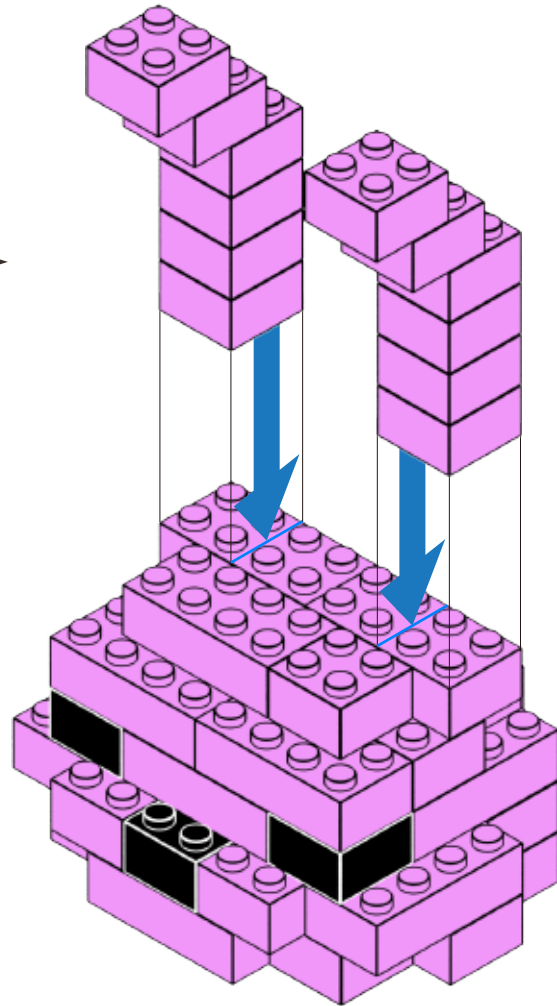

← 17



10 →

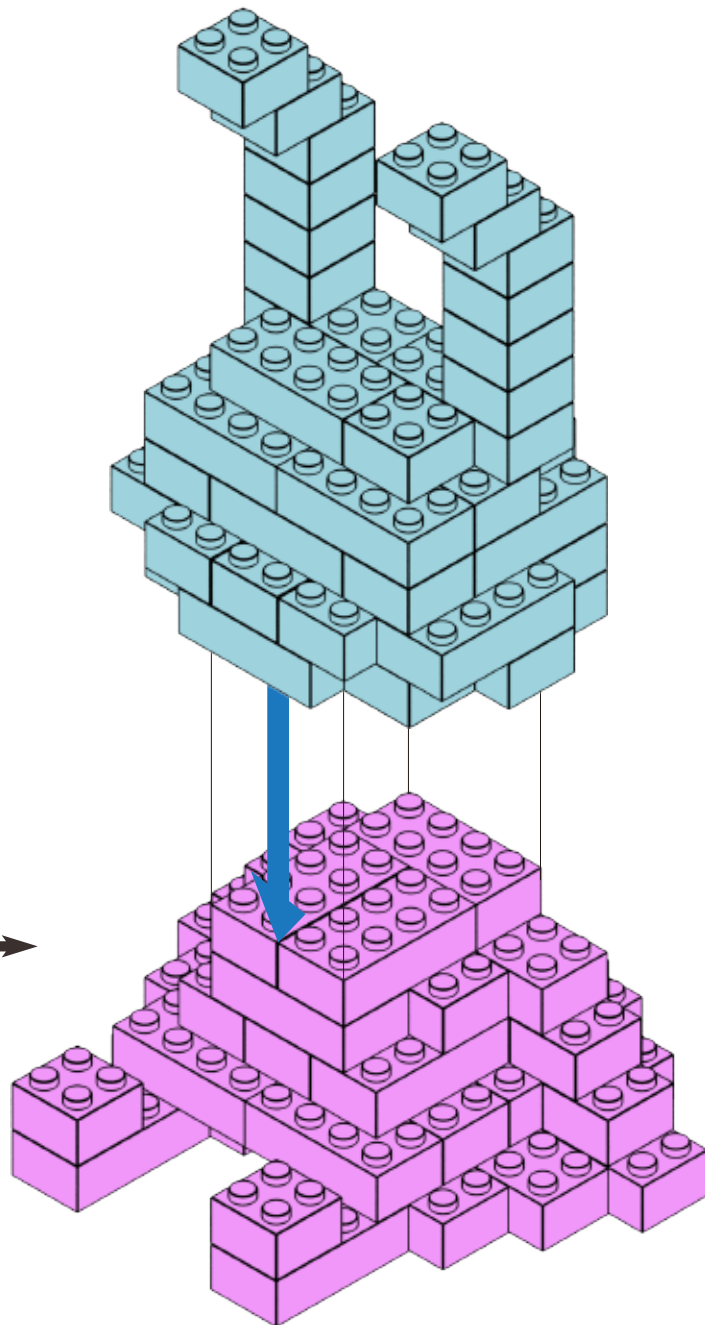

NEW

