

Apitor

SuperBot User Manual

Educational Building Block
Robot Kit (18+ in 1)

AGES 8+

400+ PCS
Model No.: ABR3



Table of Contents

About Apitor SuperBot	2
Main Control Unit	3
Battery Installation	4
Download the APP	5
Connection to Main Control Unit	6
APP Instructions	7
Building Block List	8-9
Rubber Band Tricycle Assembly Guide	10-18
Plough Car Assembly Guide	19-31
Jeep Assembly Guide	32-51
Assembly Guide for More Robots	52
FAQ	53



About Apitor SuperBot

The Apitor SuperBot is born for fun and STEM education. It contains building blocks, a main control unit, sensors and extended camera (not included, sold separately). It is compatible with various building blocks and can be built up to 18 different pre-designed robots. It supports APP/remote control (not included, sold separately) and graphical programming. Everyone can build your own robot and enjoy STEM learning in a fun way.



Engineering



Math



Science



Technology

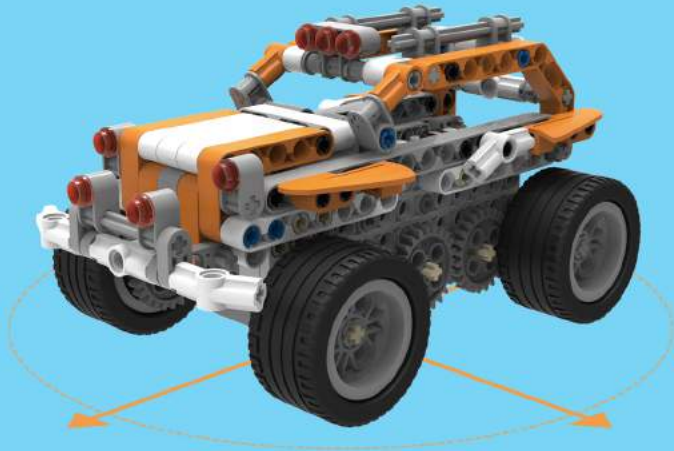

Main Control Unit

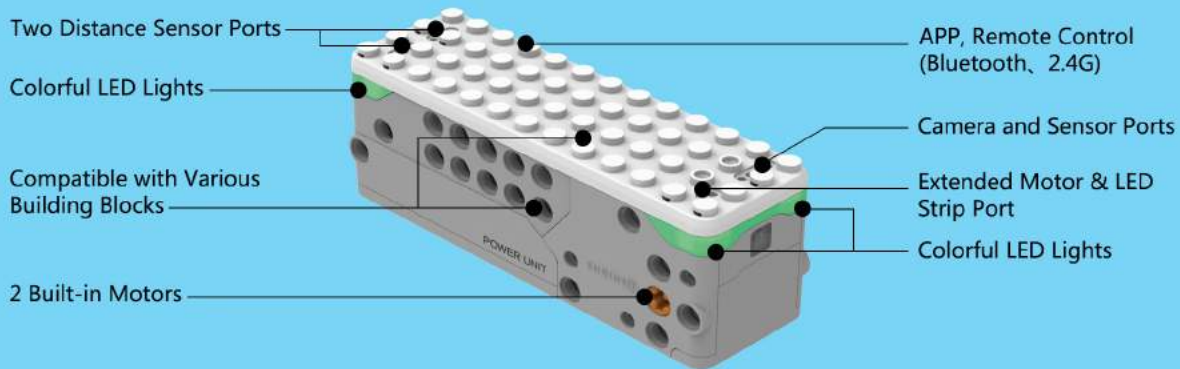

Battery Installation

Open the battery case

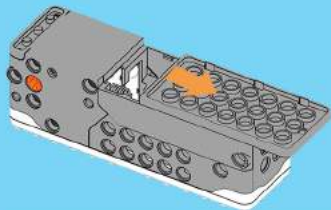

Put in 3 AA batteries

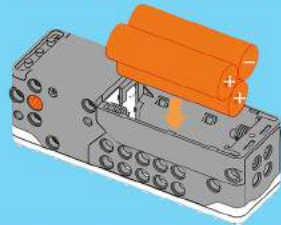

Close the battery case

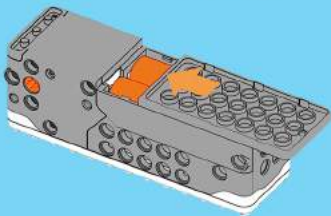

Instructions for Battery Installation

Non-rechargeable batteries cannot be charged.

Rechargeable batteries should be charged under the supervision of an adult.

Batteries with different models, old and new batteries should not be mixed.

Exhausted batteries should be removed from the product.

This product does not contain battery.

Download the APP



Download the APP by searching for "Apitor Robot" in the Apple App Store and Google Play Store.

Connection to Main Control Unit

Turn on the power of the main control unit.

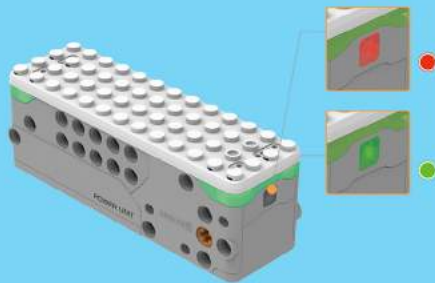

APP control mode pairing: shortly press the power button and turn on the power of the main control unit, it will flash green after 10 seconds, Turn on your device' s Bluetooth and go to the Bluetooth pairing page
Bringing your device closer to the main control unit, and the pairing completed automatically.



Remote control(not included, sold separately) mode pairing: shortly press the power button and turn on the power of the main control unit, it will flash red within 10 seconds. Bringing your Remote control(not included, sold separately) closer to the main control unit, and the pairing completed automatically.

APP Instructions



Build the selected robot by through step-by-step instructions. Control the robot to move forward/backward, turn left/right, and other actions.



Use an official program to control the robot, or create your own program to control the robot.



Learn how to code through step-by-step practice.



After you own program is completed, click the Upload button in the APP. Turn off the power of the main control unit, then press and hold for 5 seconds to turn it on. The robot starts off-line mode and runs automatically according to the uploaded program.

Building Block List

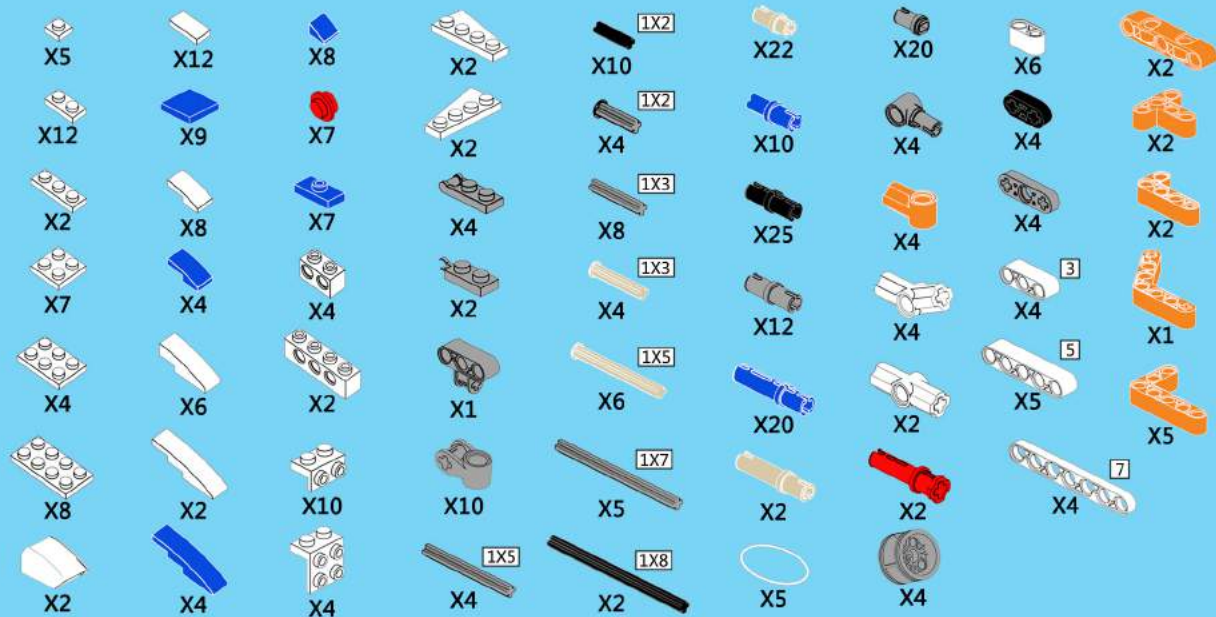

Building Block List

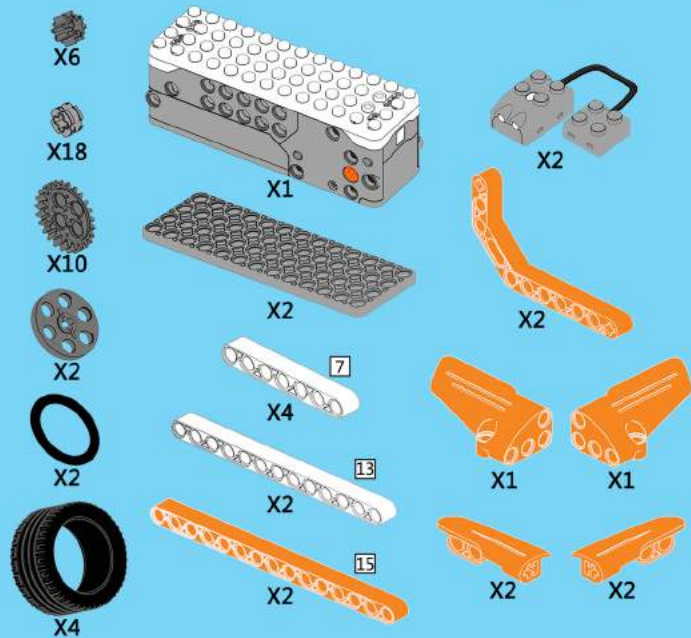

Rubber Band Tricycle

Assembly difficulty

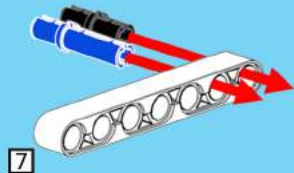
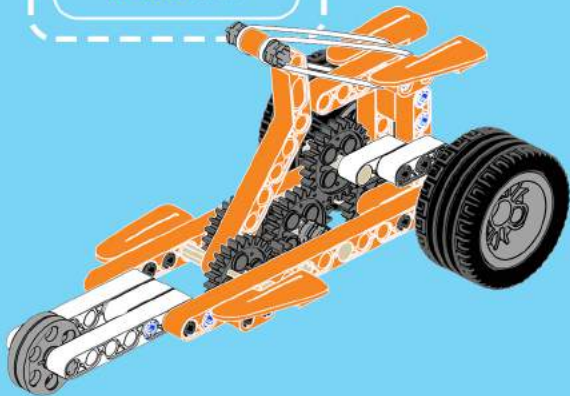

1

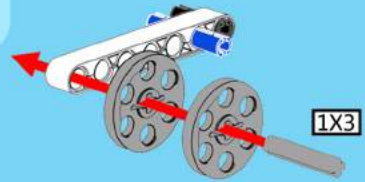
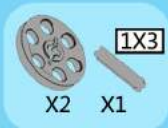

2

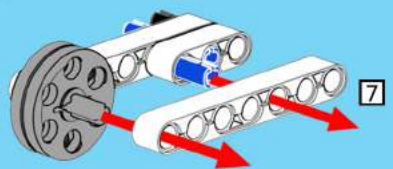
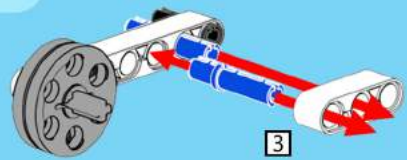

3 4
5 6

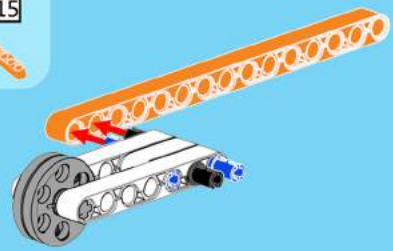
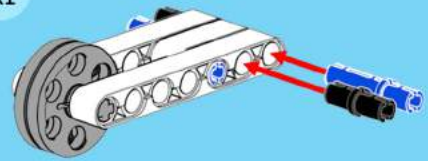

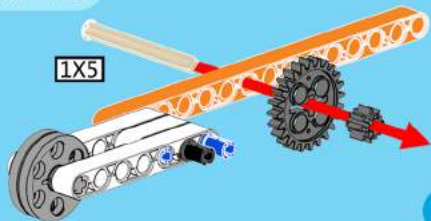

7

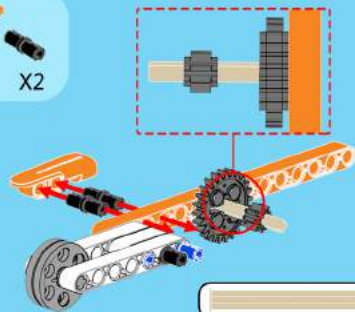

8

9

10

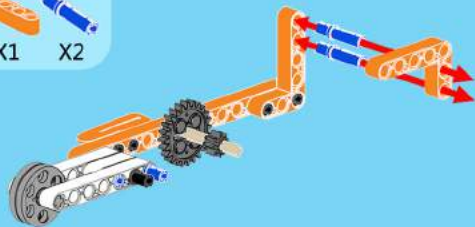
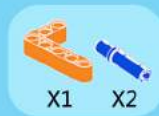
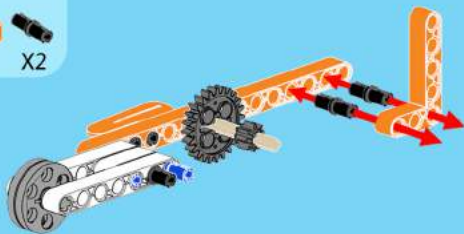

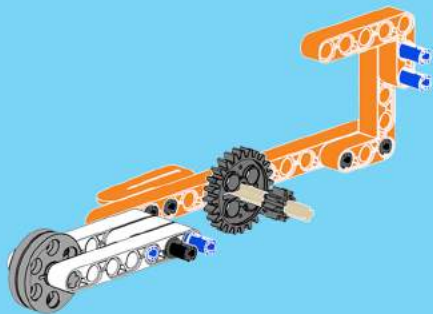

11

12

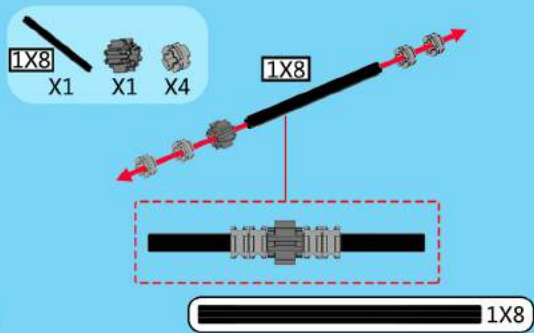

13

14

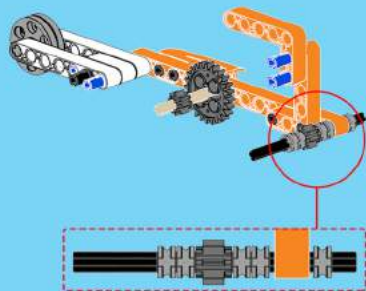
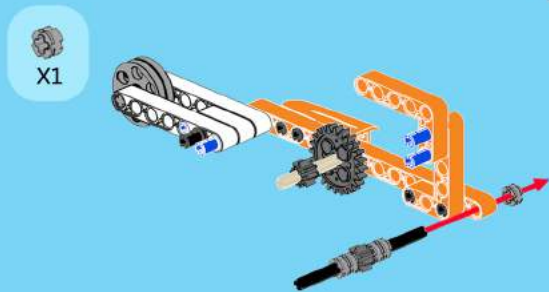

13

B



15

X1 X1 X2

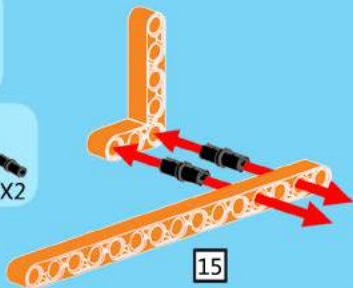

15

15

16



X1

1X5

X1

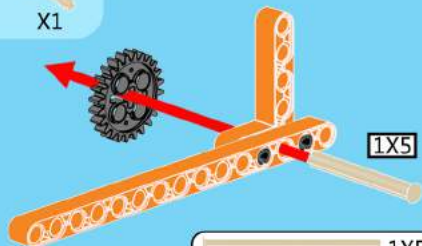

1X5



1X5

17



3

X1

X1

X2

1X3

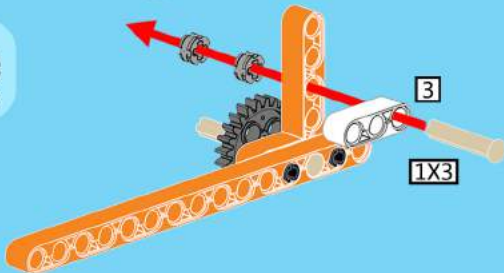

3

1X3

14

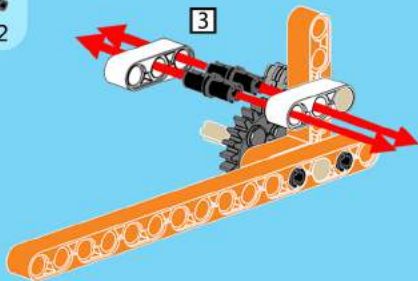

18

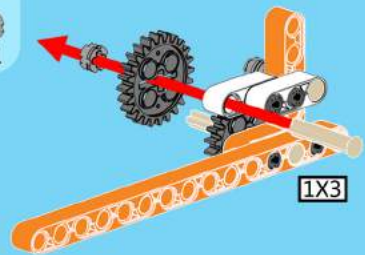

19

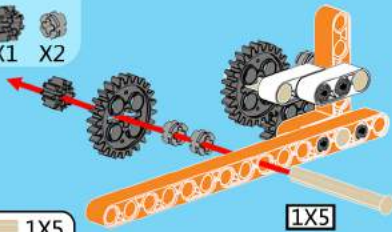

20

21

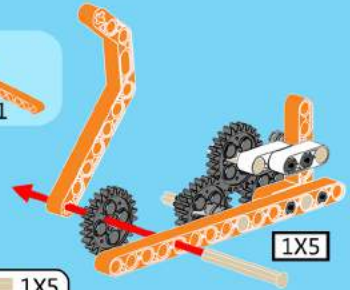

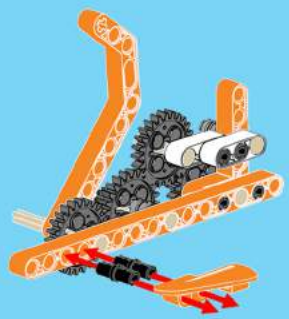

22

23

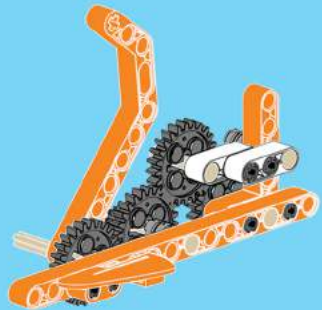

24

25

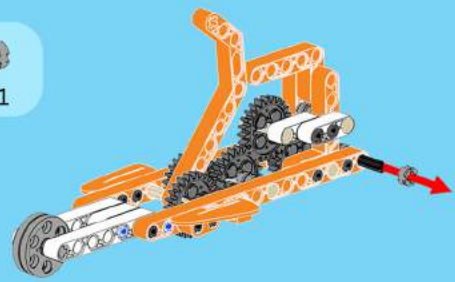
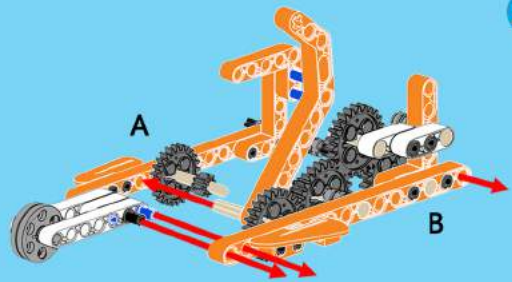

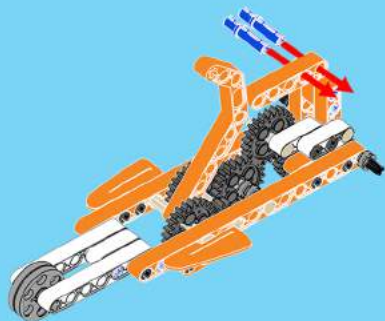

26

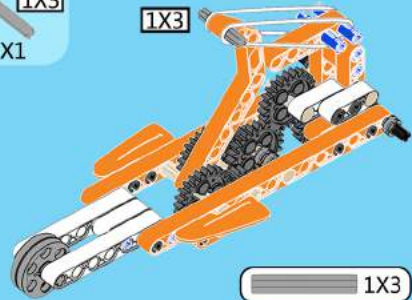
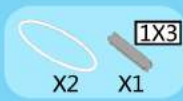

27

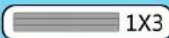

28

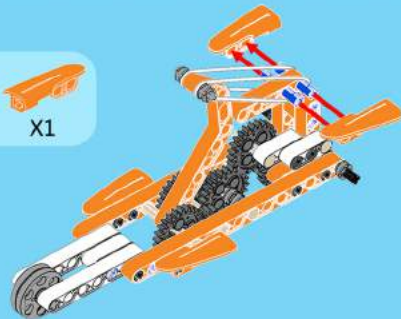
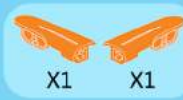

29

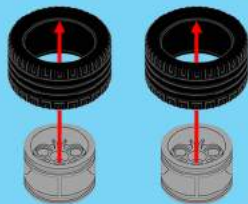

30

31

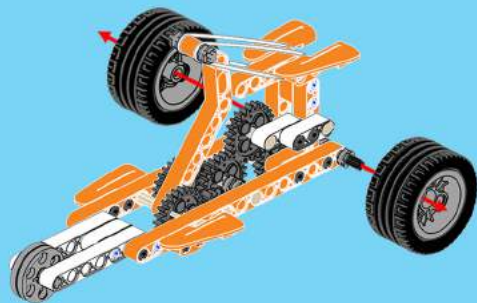

32

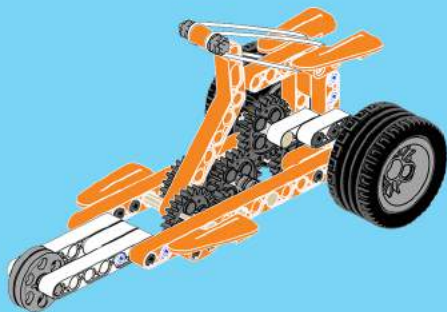

Plough Car

Assembly difficulty

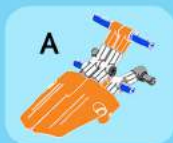
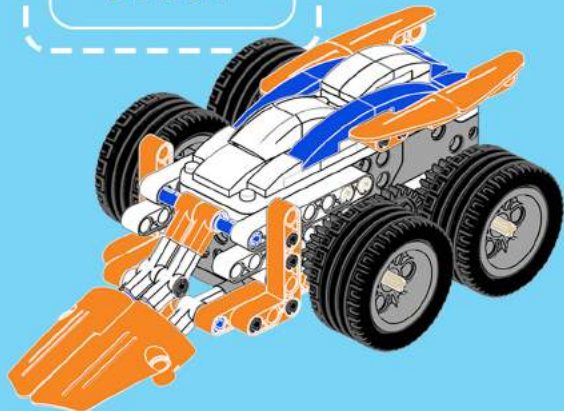

1



2

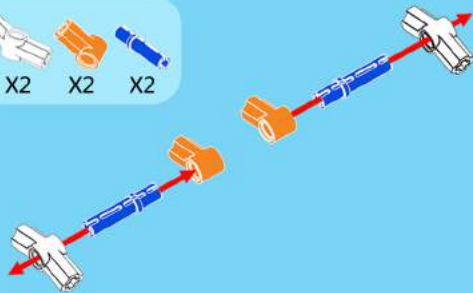

X4

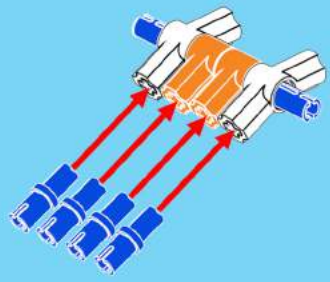

3

4

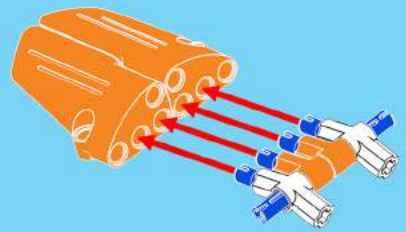

5

6

X2 X2

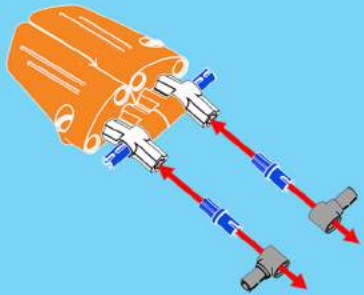

X2 X1 X2

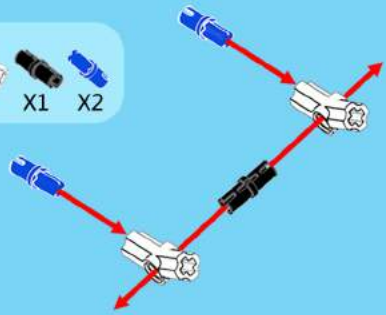

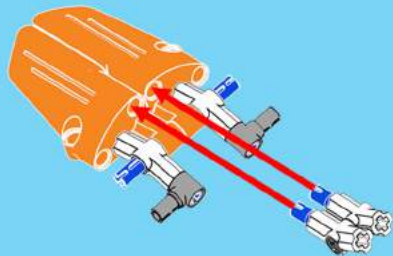

7

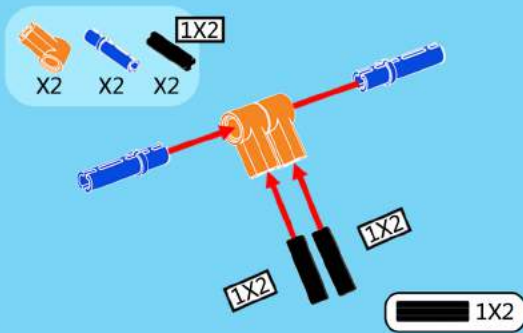

8

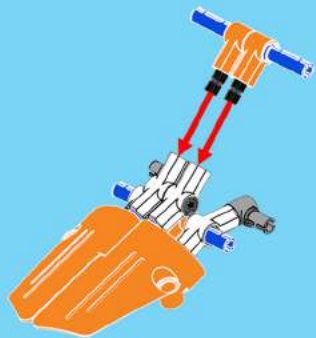

9

10

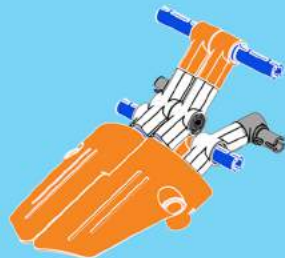

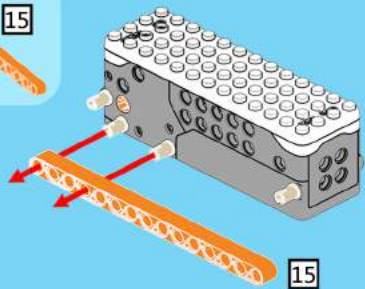
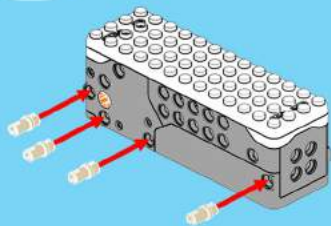

11 12

13

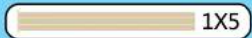
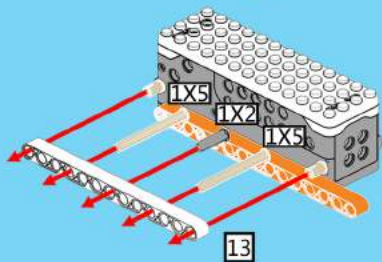
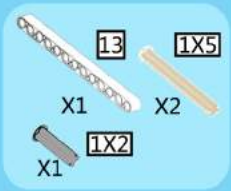

22

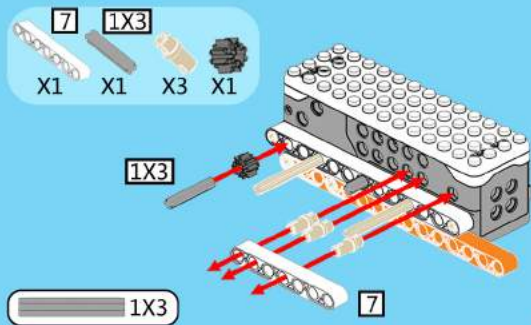

14

15

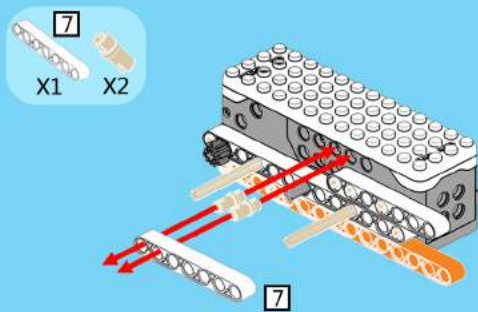

16

17

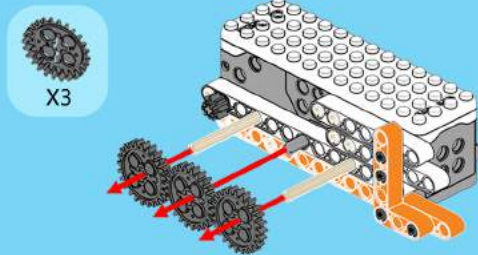
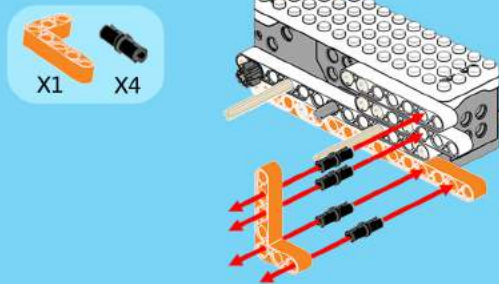



X4

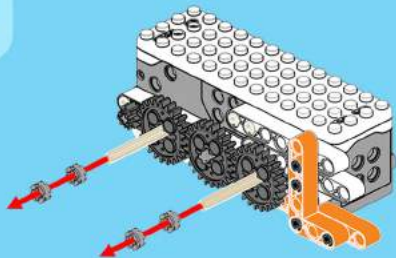

18



X2



X2

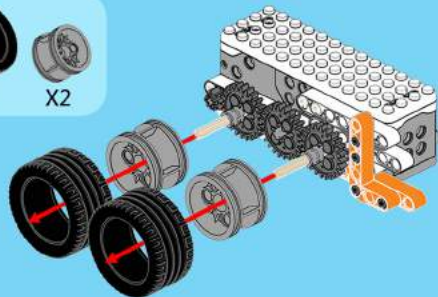

19

20

21

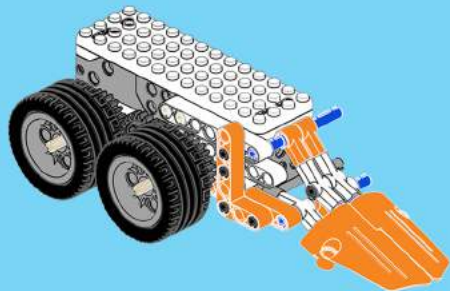
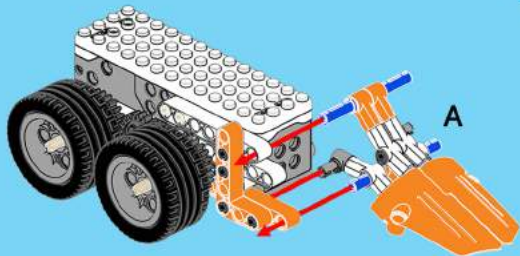

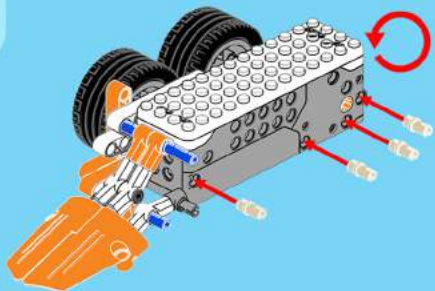

22

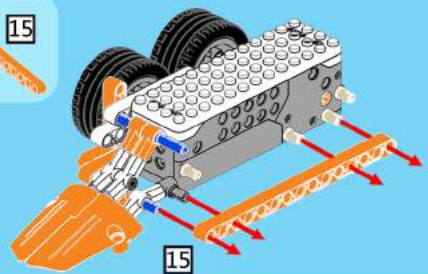

23

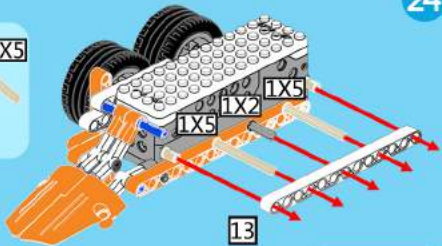
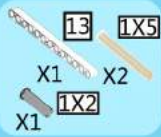

24



25

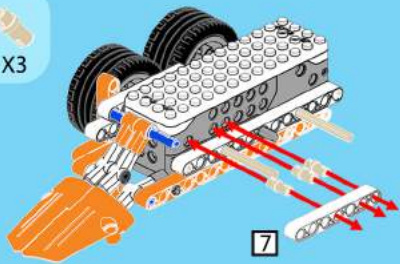
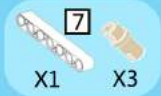

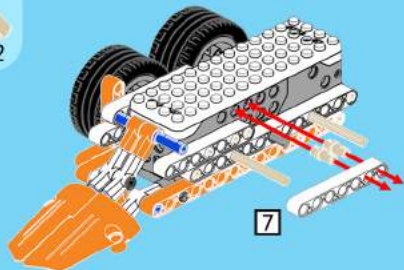

26

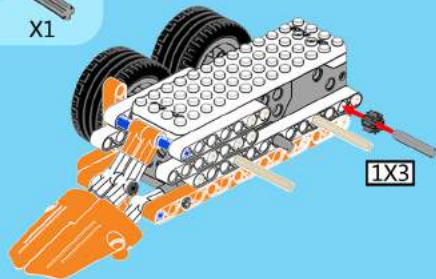

27

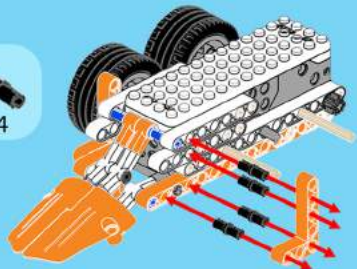

28

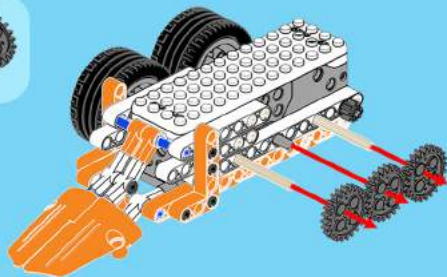

29

26



X4

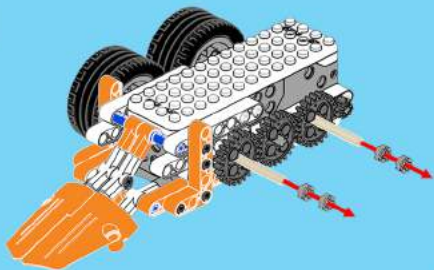

30



X2

X2

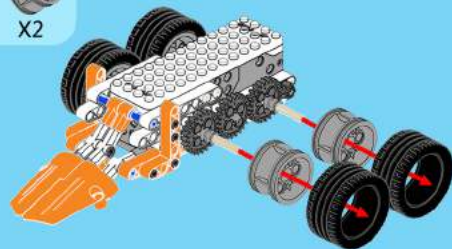

31



X4

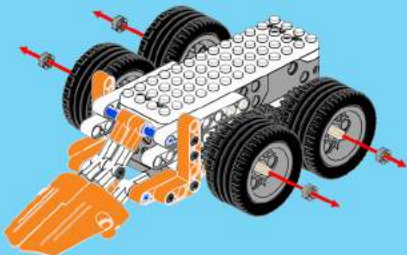

32



X1

X1

X2

33

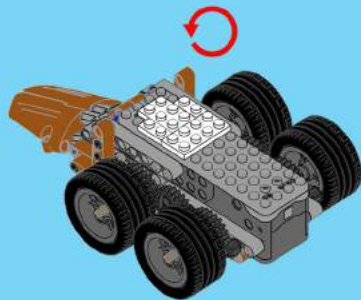

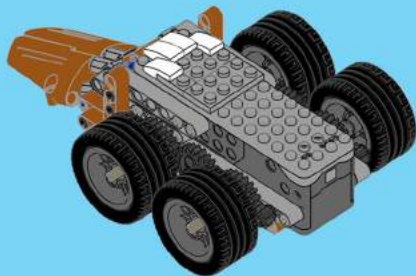

34

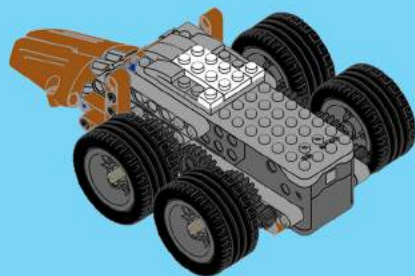

35

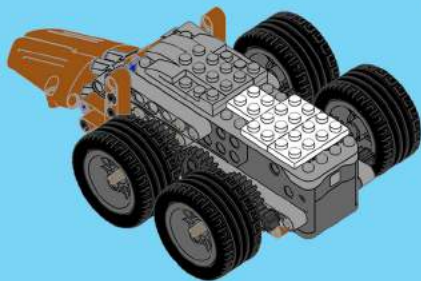
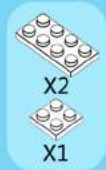

36

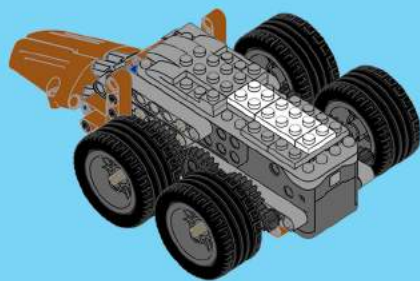

37

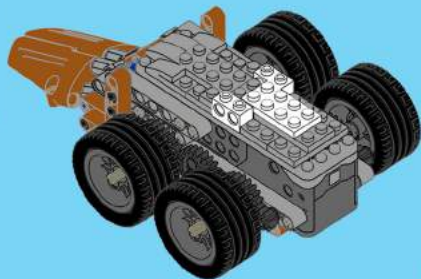

38

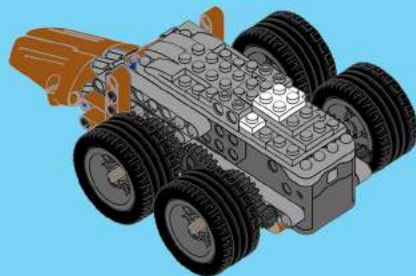

39

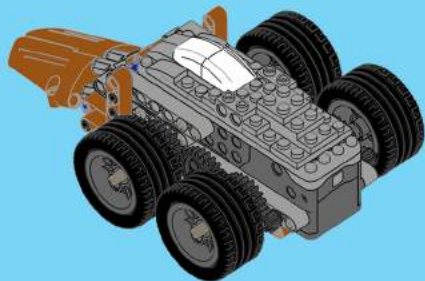

40

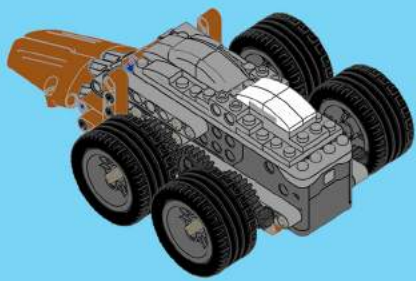

41

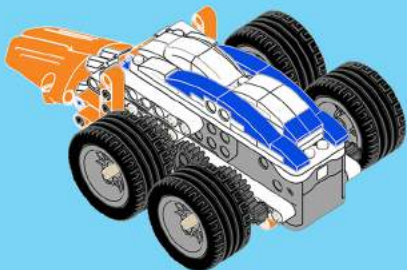
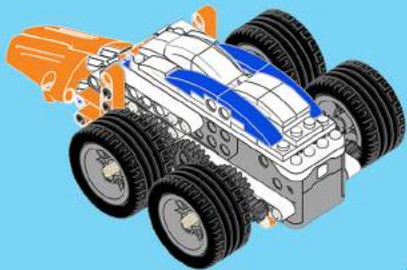

42

43

44

45

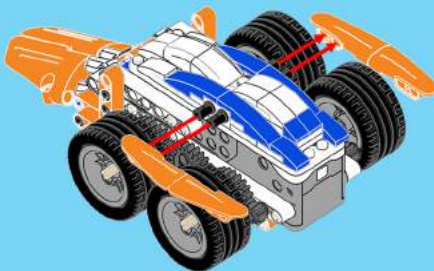
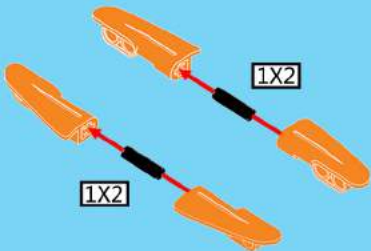
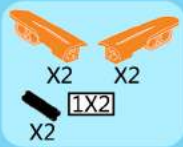

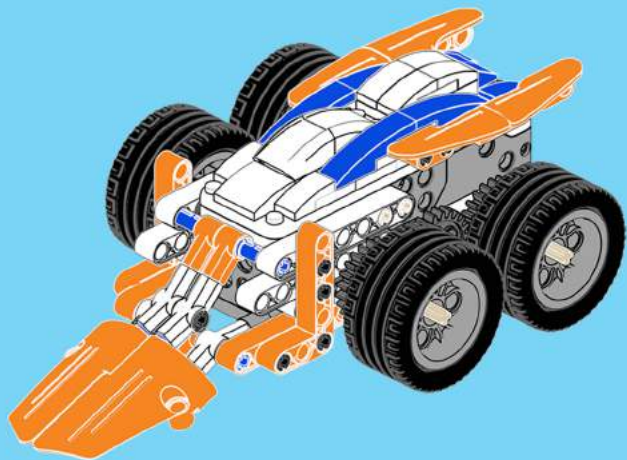

Jeep

Assembly difficulty

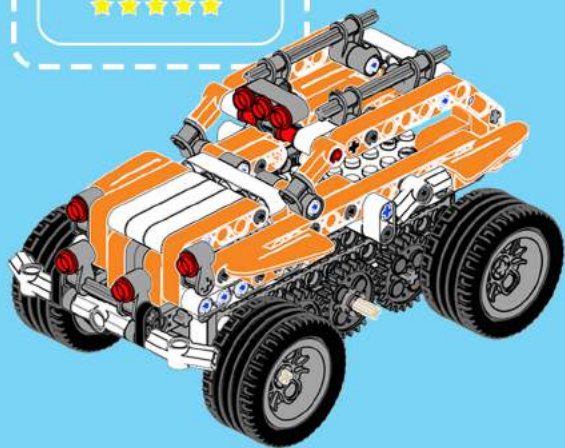

A

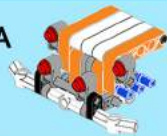

X1 X1 X2

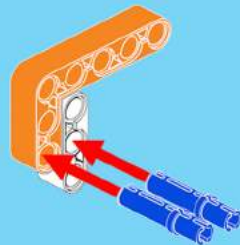

1

2



X1 X1

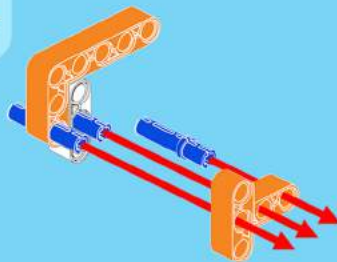

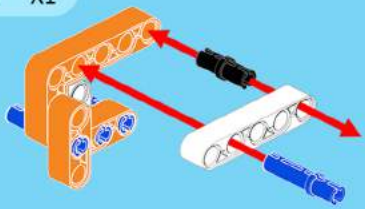

3

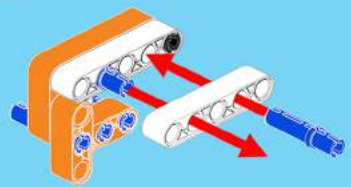

4

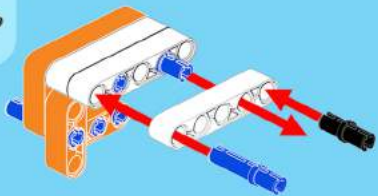

5

6

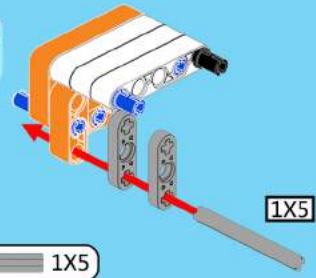

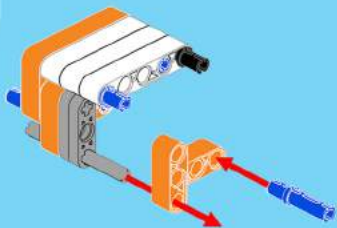

7

8

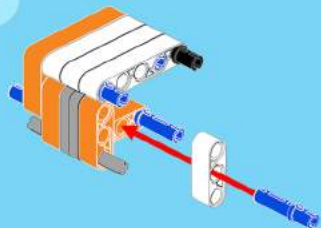

9

10

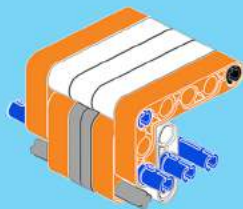
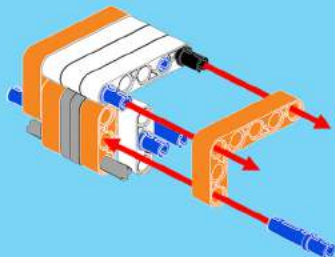
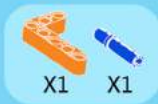

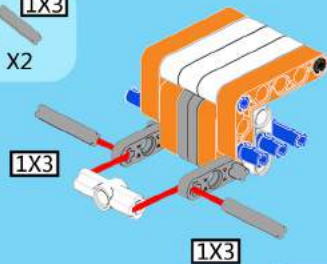
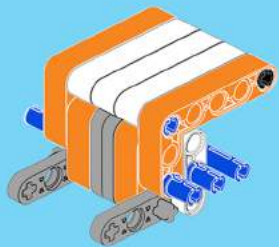

11

12

13

14

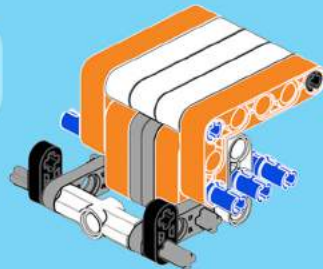
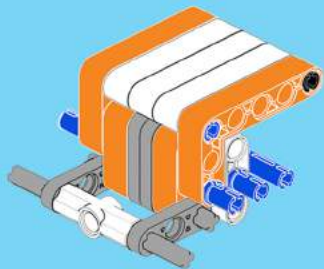

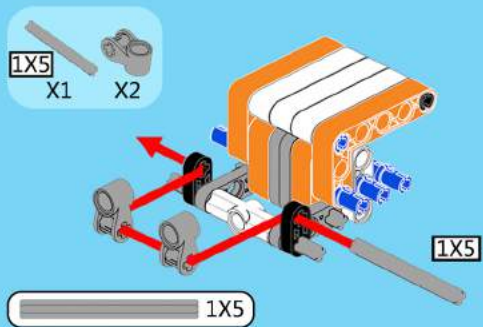

15

16

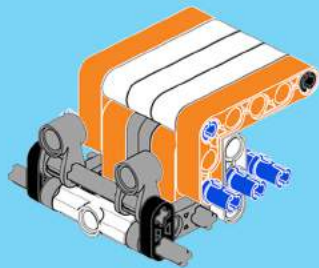

17

18

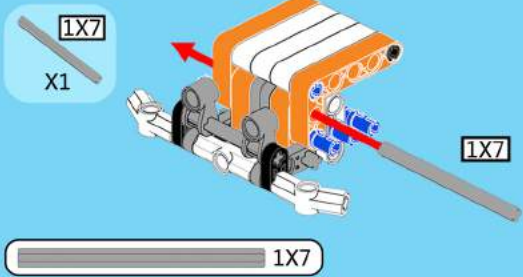
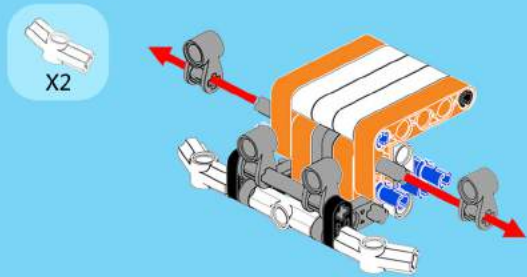

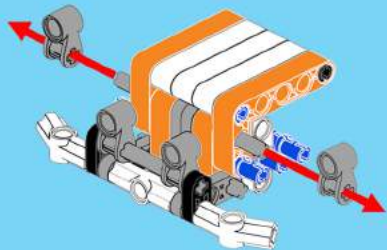

19

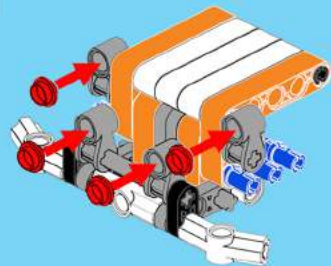

20

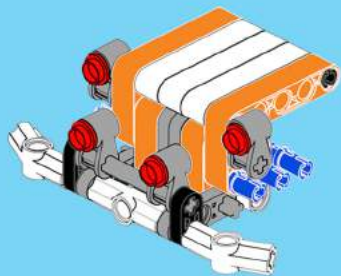

21

22

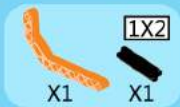
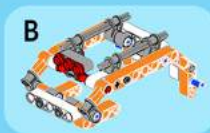

1X2

1X2

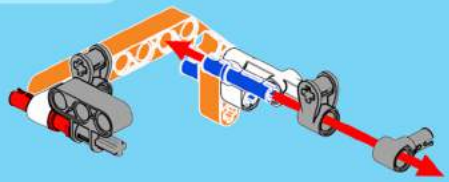

27

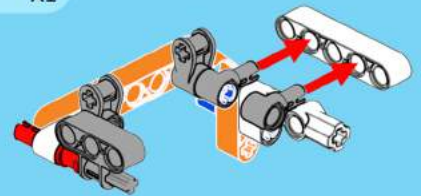

28

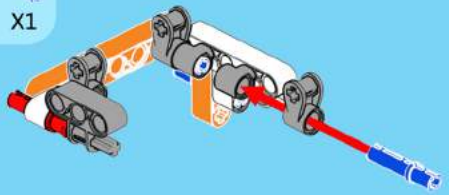

29

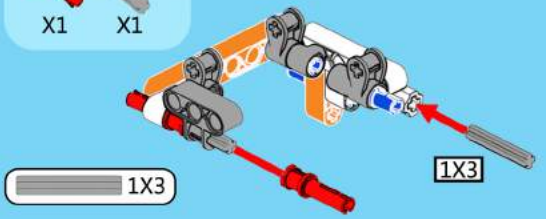

30

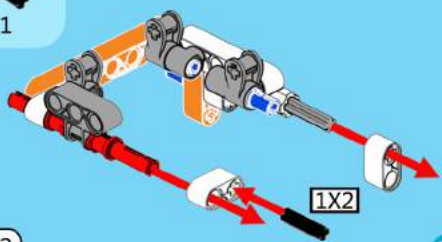

31

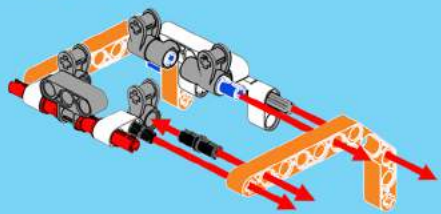

32

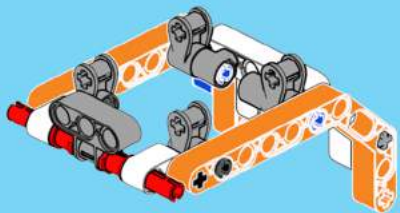

33

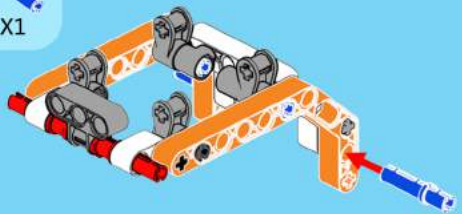

34

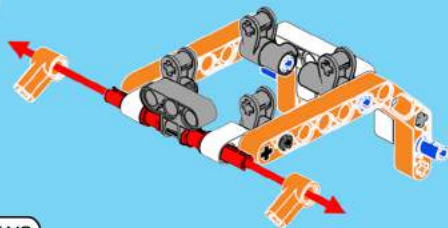

35

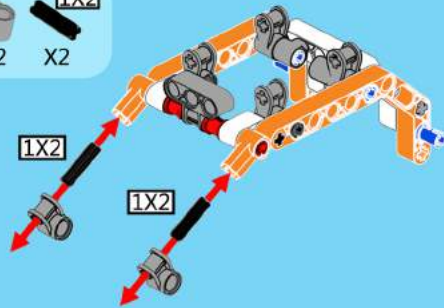
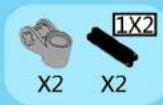

36

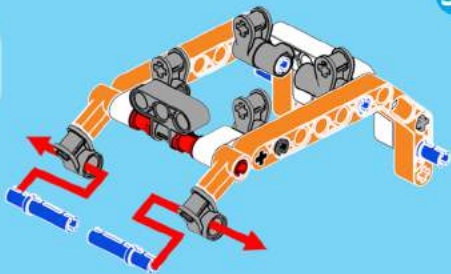

37

38

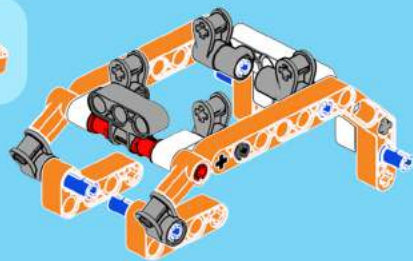



X2

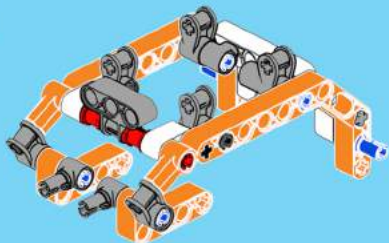

X1

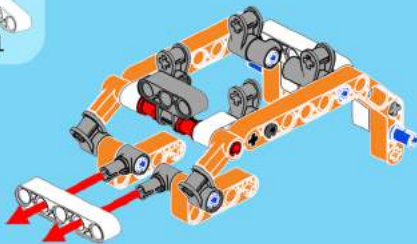

39

40

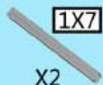

X2

1X7

1X7

1X7

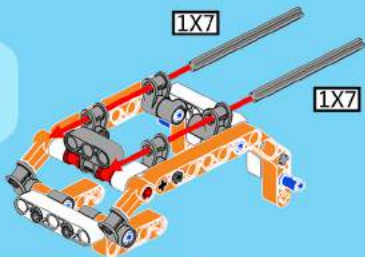

1X7

41

42



X3

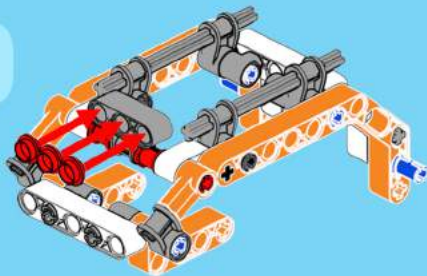

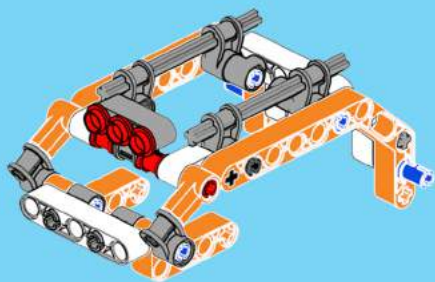

43

44



X1

X1

X5

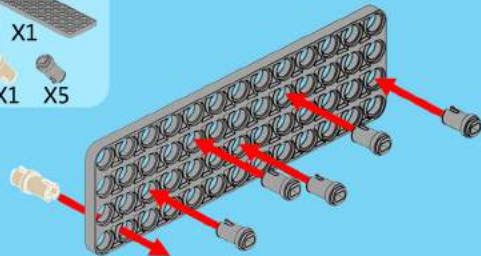

45

46



X1

X2

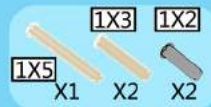
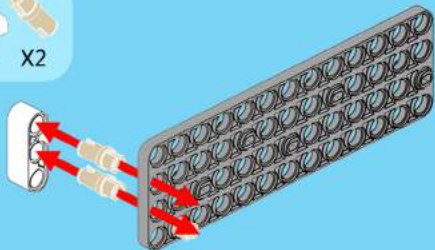

1X3

1X2

1X5

X1

X2

X2



1X5



1X3



1X2

1X2

1X3

1X2

1X5

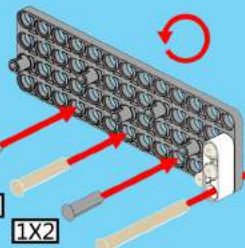

43

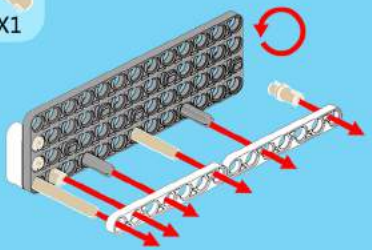

47

48

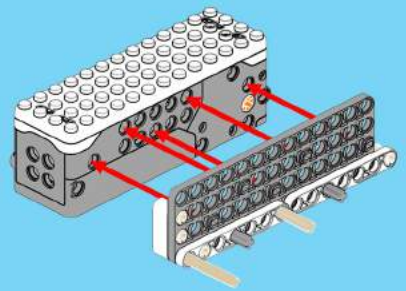

49

50

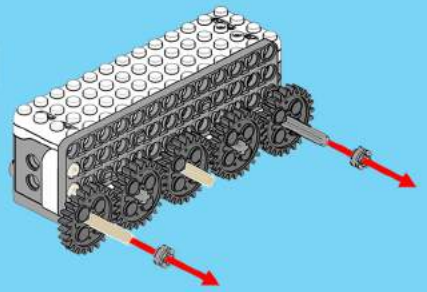
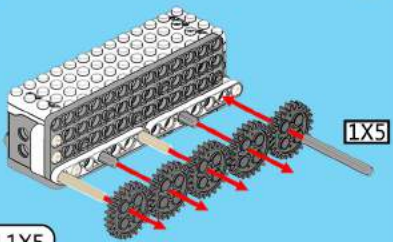
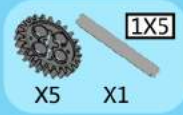

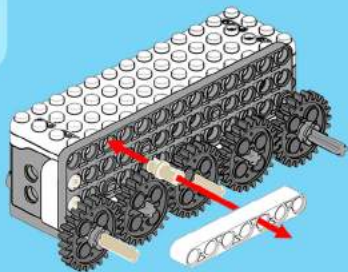

51

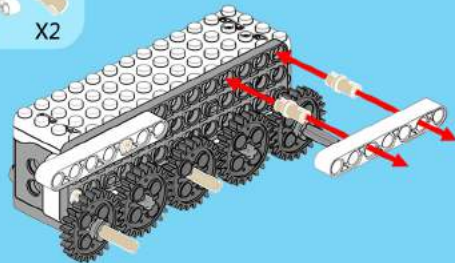

52

53

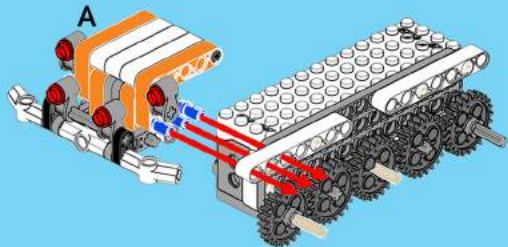

54

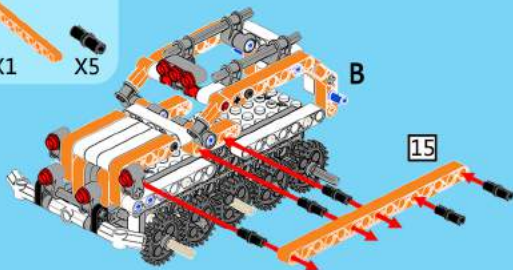

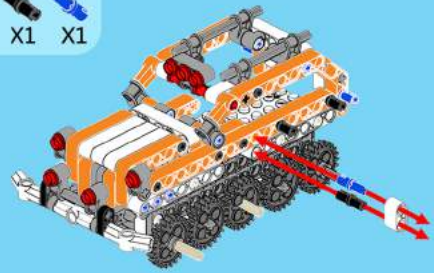

55

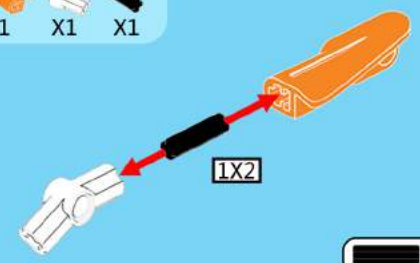

56

57

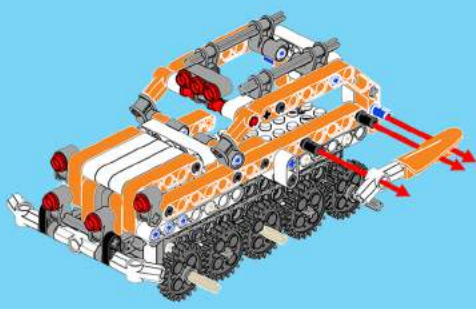

58

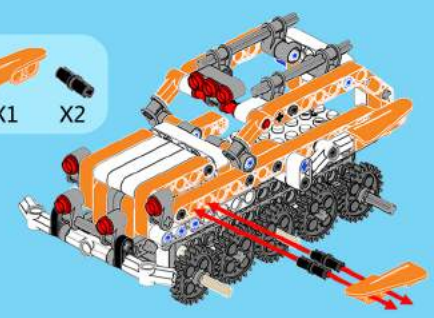

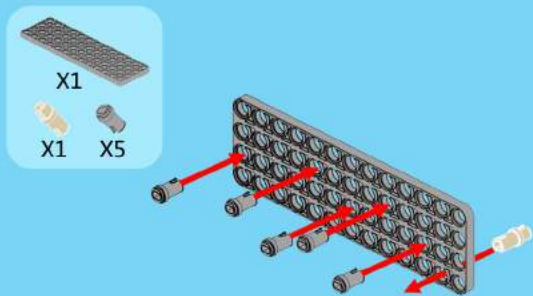

59

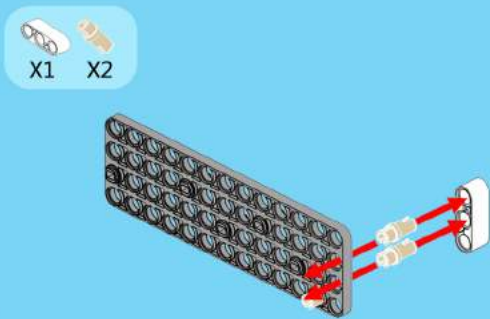

60

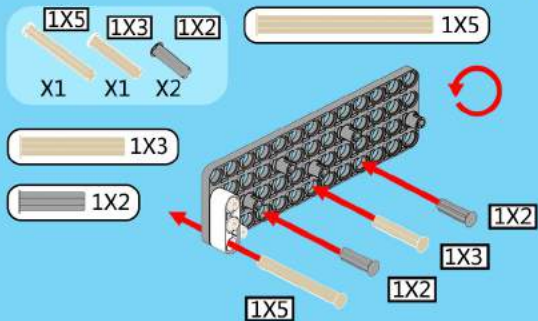

61

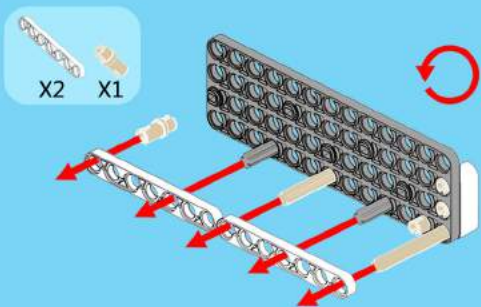

62

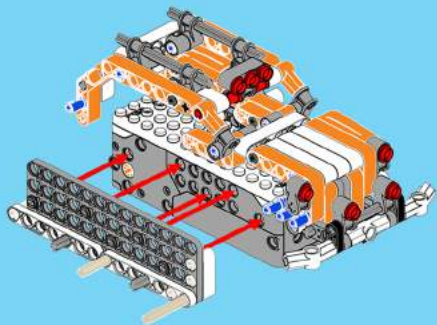

63



64

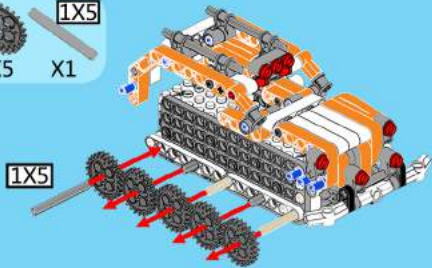

65

66

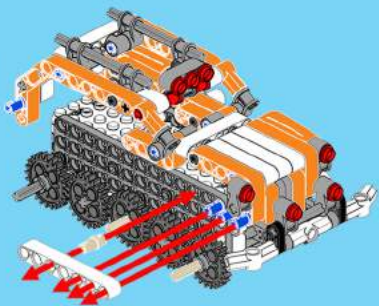
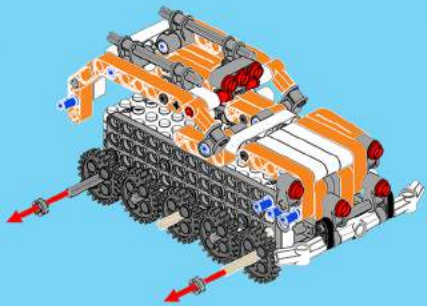

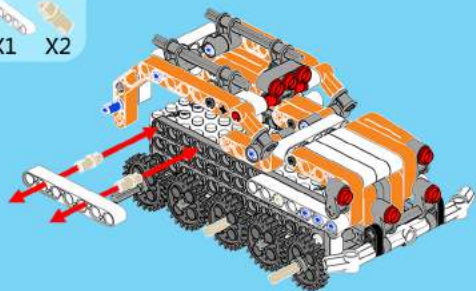

67

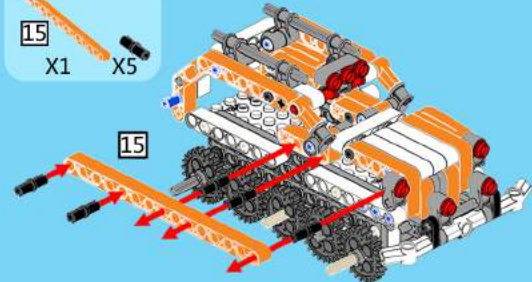

68

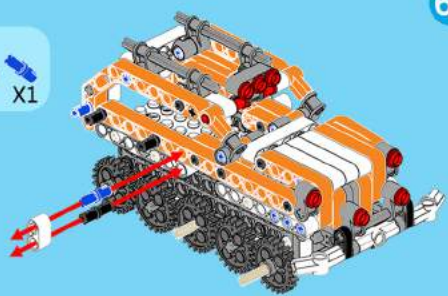

69

70

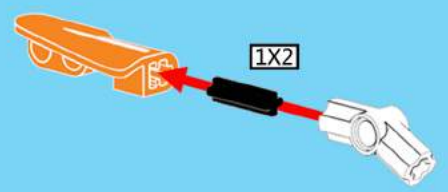
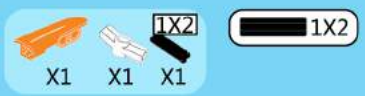

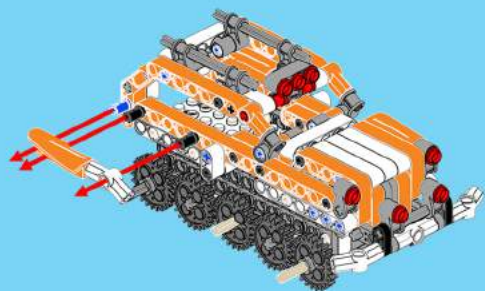

71



X1 X2

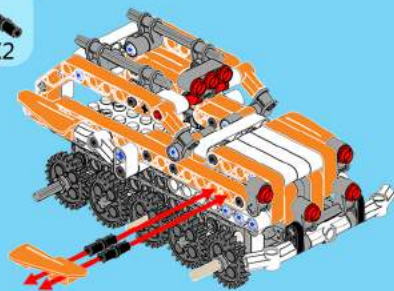

72



X4 X4

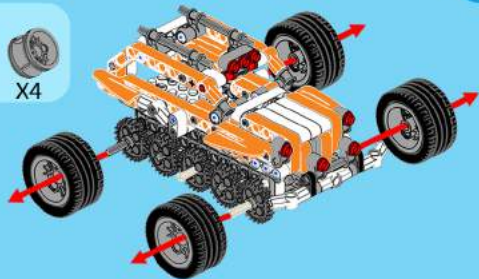

73

74



X6

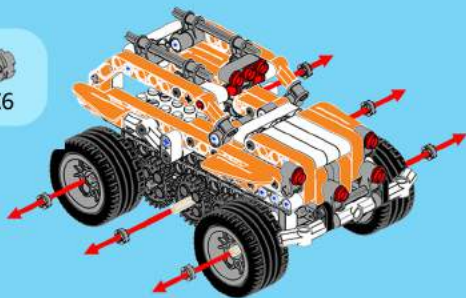

75

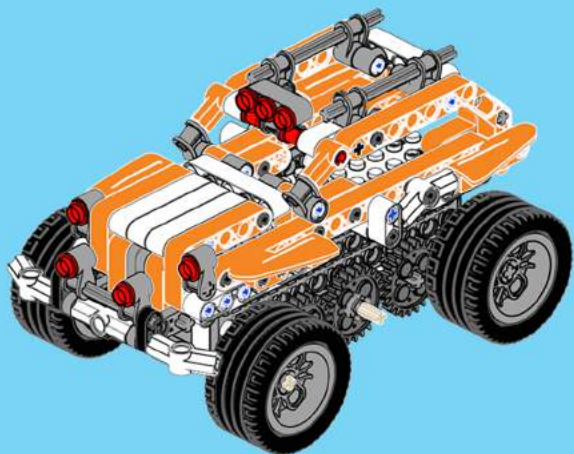

Assembly Guide for More Robots

Please find the assembly guide for 15+ more robots in the APP.



Balance



Motorcycle



Rubber Band Racing Tricycle



Delivery Man



Dragon Tiger Chariot



Tricycle



Chariot



Music Box



Telegraph Machine



Drawing Robot



Packing System



Paper Crane Robot



Tiger



Football Robot



Sumo Robot



FAQ

The main control unit cannot be paired with APP?

Please check if the Bluetooth of your device is turned on. If the Bluetooth is off, please turn it on. If the Bluetooth is turned on, please turn off the main control unit, then turn on, and restart the APP, then try to connect to Bluetooth again.

Please check if the power of main control units is enough. If not, please replace the battery.

 **WARNING:**
CHOKING HAZARD

Small parts. Not for children under 3 years.

RoHS   **CE** **FC** 

Apitor

Apitor Technology Co., Ltd.
support@apitor.com www.apitor.com