

# SAFETY AWARENESS

Whenever you see the symbols shown below, heed their instructions! Always follow safe operating and maintenance practices.

## WARNING

This warning symbol identifies special instructions or procedures which, if not correctly followed, could result in personal injury, or loss of life.

## CAUTION

This caution symbol identifies special instructions or procedures which, if not strictly observed, could result in damage to, or destruction of equipment.

## NOTE

- *This note symbol indicates points of particular interest for more efficient and convenient operation.*

# READ THIS FIRST

For your safety, read this Owner's Manual and understand it thoroughly before operating this ENGINE.

## WARNING

**DO NOT run the engine in a closed area. Exhaust gas contains carbon monoxide, an odorless and deadly poison.**

**Gasoline is extremely flammable and can be explosive under certain condition.**

Stop engine and allow the engine to cool before refueling.

**DO NOT** smoke. Make sure area is well ventilated and free from any source of flame or sparks including the pilot light of any appliance while refueling, servicing fuel system, draining gasoline and/or adjusting fuel system.

**DO NOT** fill the tank so the fuel level rises into the filler neck or level surface of level gauge. If the tank is overfilled, heat may cause the fuel to expand and overflow through the vents in the tank cap.

Wipe off any spilled gasoline immediately.

**To prevent fire hazard:**

Keep the engine at least 1 m (3.3 ft) away from buildings, obstructions and other burnable objects.

**DO NOT** place flammable objects close to the engine.

**DO NOT** expose combustible materials to the engine exhaust.

**DO NOT** use the engine on any forest covered, brush covered or grass covered unimproved land unless spark arrester is installed on the muffler.

**To avoid getting an electric shock, DO NOT touch spark plugs, plug caps or spark plug leads during engine running.**

**To avoid a serious burn, DO NOT touch a hot engine or muffler. The engine becomes hot during operation. Before you service or remove parts, stop engine and allow the engine to cool.**

**DO NOT** place hands or feet near moving or rotating parts. Place a protective cover over pulley, V belt or coupling.

**DO NOT** run engine at excessive speeds. This may result in injury.

**Always remove the spark plug caps from spark plugs when servicing the engine to prevent accidental starting.**

Read warning labels which are on the engine and understand them. If any label is missing, damaged, or worn get a replacement from your Kawasaki dealer and install it in the correct position.

# EMISSION CONTROL INFORMATION

## Fuel Information

THIS ENGINE IS CERTIFIED TO OPERATE ON UNLEADED REGULAR GRADE GASOLINE ONLY. A minimum of 87 octane of the antiknock index is recommended. The antiknock index is posted on service station pumps in the U.S.A.

## Emission Control Information

To protect the environment in which we all live, Kawasaki has incorporated an exhaust emission control system in compliance with applicable regulations of the United States Environmental Protection Agency and the California Air Resources Board. Also, depending on when your engine was produced, it may have an assigned emissions durability period. \* See below for the engine emissions durability period that may apply to your engine.

## Exhaust Emission Control System

The exhaust emission control system applied to this engine consists of a fuel system and an ignition system having optimum ignition timing characteristics. The fuel system has been calibrated to provide lean air/fuel mixture characteristics and optimum fuel economy with a suitable air cleaner and exhaust system.

A sealed-type crankcase emission control system is also used to eliminate blow-by gasses. The blow-by gasses are led to a breather chamber through the crankcase and from there to the air cleaner.

## Engine Emissions Compliance Period

### California

#### Engines Greater Than or Equal To 225 cc

Model Year – 2008 and later  
Durability Period – 1000 hours

### All Other States

#### Engines Greater Than or Equal To 225 cc

Model Year – 2007 and later  
Durability Period – 1,000 hours (Category A)

**If your engine has an assigned emissions durability period it will be located on the certification label attached to the engine (IMPORTANT ENGINE INFORMATION).**

## **High Altitude Performance Adjustment Information**

To improve the EMISSIONS CONTROL PERFORMANCE of engines operated above 1,000 meters (3,300 feet) , Kawasaki recommends the following Environmental Protection Agency (EPA) and the California Air Resources Board (CARB) approved modifications.

However, the models with DFI (Digital Fuel Injection system) does not require high altitude performance adjustment.

### **NOTE**

○ *When properly performed, these specified modifications only are not considered to be emissions system "tampering" and engine performance is generally unchanged as a result.*

## **Maintenance and Warranty**

Proper maintenance is necessary to ensure that your engine will continue to have low emission levels. This Owner's Manual contains those maintenance recommendations for your engine. Those items identified by the Periodic Maintenance Chart are necessary to ensure compliance with the applicable standards.

As the owner of the engine, you have the responsibility to make sure that the recommended maintenance is carried out according to the instructions in this Owner's Manual at your own expense.

The Kawasaki Limited Emission Control System Warranty requires that you return your engine to an authorized Kawasaki dealer for remedy under warranty. Please read the warranty carefully, and keep it valid by complying with the owner's obligations it contains.

## **Tampering with Emission Control System Prohibited**

Federal law and California State law prohibit the following acts or the causing thereof: (1) the removal or rendering inoperative by any person other than for purposes of maintenance, repair, or replacement, of any device or element of design incorporated into any new engine for the purposes of emission control prior to its sale or delivery to the ultimate purchaser or while it is in use, or (2) the use of the engine after such device or element of design has been removed or rendered inoperative by any person.

Among those acts presumed to constitute tampering are the acts listed below:  
Do not tamper with the original emission related parts:

- Carburetor or DFI system, and their internal parts
- Spark Plug
- Magneto or electronic ignition system
- Fuel filter element
- Air cleaner element
- Crankcase
- Cylinder heads
- Breather chamber and internal parts
- Intake pipe and tube
- Muffler or any internal portion of the muffler

# FOREWORD

We wish to thank you for purchasing this Kawasaki engine.

**Please read this Owner's Manual carefully before starting your new engine** so that you will be thoroughly familiar with the proper operation of your engine's control, its features, capabilities and limitations.

Also read the manual of the equipment to which this engine is attached.

To ensure a long, trouble-free life for your engine, give it the proper care and maintenance described in this manual. Always keep this manual at your fingertip so that you can refer to it whenever you need information. This manual should be considered a permanent part of the engine and should remain with the engine when it is sold.

All rights reserved. No part of this publication may be reproduced without our prior written permission.

This publication includes the latest information available at the time of printing. However, there may be minor differences between the actual product and illustrations and text in this manual.

All products are subject to change without prior notice or obligation.

**KAWASAKI HEAVY INDUSTRIES, LTD.**  
**Consumer Products & Machinery Company**

---

# TABLE OF CONTENTS





---

<b>GENERAL INFORMATION</b> .....	8	Choke Cable Installation, Adjustment .....	23
Safety Related Labels .....	8	Engine Speed Adjustment .....	25
Parts Location (Standard Air Cleaner Model) .....	9	<b>MAINTENANCE</b> .....	26
Parts Location (Heavy Duty Air Cleaner Model) .....	10	Periodic Maintenance Chart .....	26
Engine Serial Number .....	11	Oil Level Check .....	29
Tune-up Specifications .....	12	Oil Change .....	30
Coolant and Engine Oil Capacity .....	12	Oil Filter Change .....	31
<b>FUEL AND OIL RECOMMENDATIONS</b> .....	13	Cooling System Inspection .....	32
Fuel .....	13	Air Cleaner Service .....	33
Engine Oil .....	14	Standard Air Cleaner Type .....	33
<b>PREPARATION</b> .....	15	Foam Element .....	33
Fuel .....	15	Paper Element .....	33
Engine Oil .....	15	Heavy Duty Air Cleaner Type .....	34
Coolant .....	16	Primary Element .....	35
<b>STARTING</b> .....	18	Secondary Element .....	35
Start Engine .....	18	Cap (Dust Ejector Valve) .....	35
<b>OPERATING</b> .....	20	Fuel Filter and Fuel Pump Service .....	36
Warming Up .....	20	Spark Plug Service .....	37
Engine Inclination .....	21	<b>STORAGE</b> .....	39
<b>STOPPING</b> .....	22	Fuel System Draining .....	39
Ordinary Stop .....	22	<b>TROUBLESHOOTING GUIDE</b> .....	41
Emergency Stop .....	22	<b>ENVIRONMENTAL PROTECTION</b> .....	43
<b>ADJUSTMENT</b> .....	23	<b>SPECIFICATIONS</b> .....	44
Throttle Cable Installation, Adjustment .....	23	<b>WIRING DIAGRAM</b> .....	45
		Wiring Diagram .....	45

# GENERAL INFORMATION

## Safety Related Labels

**WARNING**

-  • FOR SAFE OPERATION READ OWNER'S MANUAL.
-  • GASOLINE IS FLAMMABLE. KEEP AWAY FROM FLAME OR SPARKS.
-  • EXHAUST GAS IS POISONOUS. DO NOT RUN ENGINE IN AN ENCLOSED AREA.
-  • TO AVOID BURN, DO NOT TOUCH HOT MUFFLER.

EB02034BM2 C

Warning Label

**ENGINE MAINTENANCE**



- 1. CHECK OIL LEVEL
- 2. CHECK & CLEAN AIR CLEANER
- 3. CLEAN SCREEN & FINS
- 4. CHANGE OIL & OIL FILTER

REFER TO OWNER'S MANUAL FOR FURTHER INFORMATION

EB02035BM2 C

Maintenance Label



**Parts Location (Standard Air Cleaner Model)**

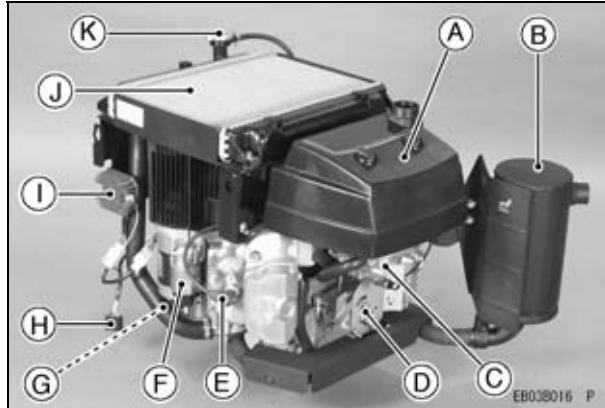

- A. Air Cleaner
- B. Muffler
- C. Carburetor
- D. Speed Control Panel
- E. Spark Plug Caps/Spark Plugs
- F. Electric Starter
- G. Oil Drain Plugs
- H. Packard Connector
- I. Voltage Regulator
- J. Radiator
- K. Radiator Cap

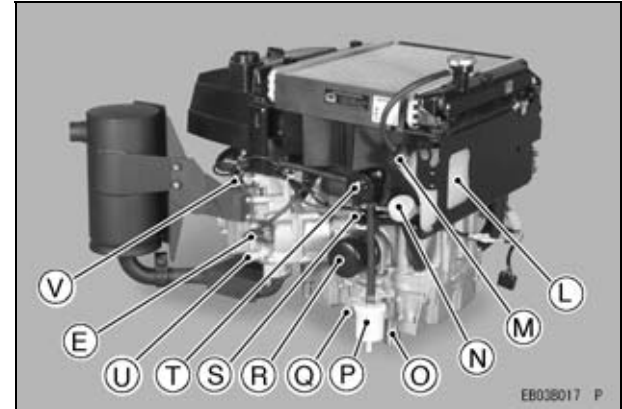

- L. Overflow Reservoir
- M. Overflow Reservoir Cap
- N. Oil Gauge/Oil Filler Cap
- O. P.T.O. Shaft
- P. Fuel Filter
- Q. Oil Drain Plugs
- R. Oil Filter
- S. Oil Pressure Switch
- T. Fuel Pump
- U. Coolant Drain Plug
- V. Coolant Temperature Switch

## 10 GENERAL INFORMATION

### Parts Location (Heavy Duty Air Cleaner Model)

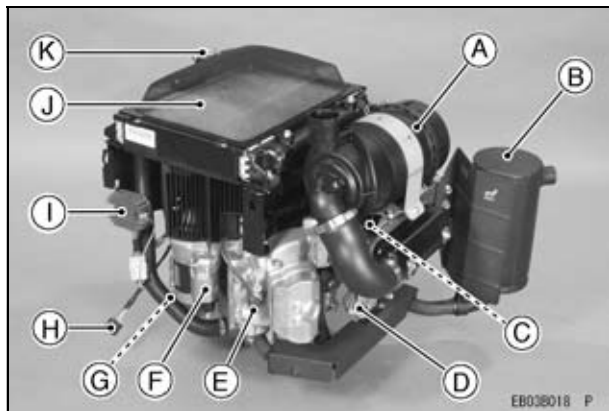

- A. Air Cleaner
- B. Muffler
- C. Carburetor
- D. Speed Control Panel
- E. Spark Plug Caps/Spark Plugs
- F. Electric Starter
- G. Oil Drain Plugs
- H. Packard Connector
- I. Voltage Regulator
- J. Radiator/Screen of Radiator
- K. Radiator Cap



- L. Overflow Reservoir
- M. Overflow Reservoir Cap
- N. Oil Gauge/Oil Filler Cap
- O. P.T.O. Shaft
- P. Fuel Filter
- Q. Oil Drain Plugs
- R. Oil Filter
- S. Oil Pressure Switch
- T. Fuel Pump
- U. Coolant Drain Plug
- V. Coolant Temperature Switch

---

## Engine Serial Number

---

The engine serial number (A) is the only means of identifying your particular engine from others of the same model type.

This engine serial number is needed by your dealer when ordering parts.

**(Standard Air Cleaner Model)**



**A. Engine Serial Number Label**

**(Heavy Duty Air Cleaner Model)**



**A. Engine Serial Number Label**

## 12 GENERAL INFORMATION

### Tune-up Specifications

ITEM	Specifications
Ignition Timing	Unadjustable
Spark Plugs: Gap	FD731V NGK BPR4ES
Low Idle Speed	1 550 r/min (rpm)
High Idle Speed	3 600 r/min (rpm)
Valve Clearance	In 0.15 mm (0.006 in) Ex 0.15 mm (0.006 in)
Other Specifications	No other adjustment needed

#### NOTE

○ *High and low idle speeds may vary depending on the equipment on which the engine is used. Refer to the equipment specification.*

### Coolant and Engine Oil Capacity

#### Coolant Capacity

FD731V	2.7 L (2.9 US.qt)
--------	-------------------

Type: Permanent Type of Antifreeze.  
Green Colored

Mixed Ratio: Water 50%: Antifreeze 50% (1 :  
1)

Freezing Point: -35°C (-31°F)

#### Engine Oil Capacity

FD731V	2.0 L (2.1 US·qt) [when oil filter is not removed]
	2.3 L (2.4 US·qt) [when oil filter is removed]

---

# FUEL AND OIL RECOMMENDATIONS

---



---

## Fuel

---

Use only clean, fresh, unleaded regular grade gasoline.

<b>CAUTION</b>
<b>Do not mix oil with gasoline.</b>

### Octane Rating

The octane rating of a gasoline is a measure of its resistance to “knocking”. Using a minimum of 87 octane by the antiknock index is recommended. The antiknock index is posted on service station pumps in the U.S.A.

**Antiknock Index: (RON + MON)/2**

**RON = Research Octane Number**

**MON = Motor Octane Number**

### NOTE

○ If “knocking or singing” occurs, use a different brand of gasoline or higher octane rating.

### Oxygenated Fuel

Oxygenates (either ethanol or MTBE) are added to the gasoline. If you use the oxygenated fuel be sure it is unleaded and meets the minimum octane rating requirement.

The following are the EPA approved percentages of fuel oxygenates.

**ETHANOL:** (Ethyl or Grain Alcohol)

You may use gasoline containing up to 10% ethanol by volume.

**MTBE:** (Methyl Tertiary Butyl Ether)

You may use gasoline containing up to 15% MTBE by volume.

**METHANOL:** (Methyl or Wood Alcohol)

You may use gasoline containing up to 5% methanol by volume, as long as it also contains cosolvents and corrosion inhibitors to protect the fuel system. Gasoline containing more than 5% methanol by volume may cause starting and/or performance problems. It may also damage metal, rubber, and plastic parts of your fuel system.

## 14 FUEL AND OIL RECOMMENDATIONS

---

### Engine Oil

---

The following engine oils are recommended.  
API Service Classification : SF, SG, SH or SJ.

#### Oil Viscosity

Choose the viscosity according to the temperature as follows:

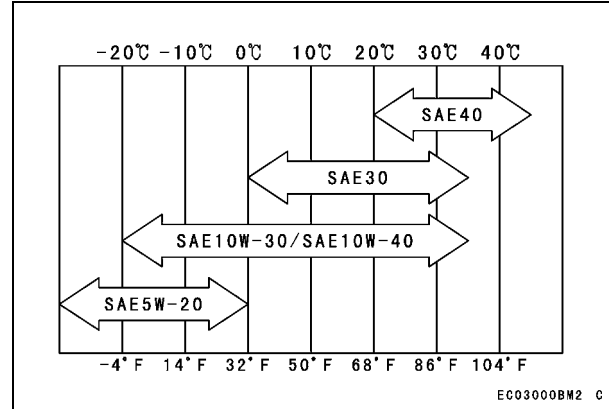

#### NOTE

- Using multi grade oils (5W-20, 10W-30, and 10W-40) will increase oil consumption. Check oil level more frequently when using them.

# PREPARATION

## Fuel

### WARNING

**Gasoline is extremely flammable and can be explosive under certain conditions**

**Before refueling, turn the engine switch to the OFF position. Do not smoke. Make sure the area is well ventilated and free from any source of flame or sparks, including any appliances with a pilot light.**

**Never fill tank so that fuel level rises into the filler neck. If tank is overfilled, heat may cause fuel to expand and overflow through vents in tank cap.**

**After refueling make sure tank cap is securely closed.**

**If gasoline is spilled, wipe it up immediately.**

- Level the engine before fueling.
- Remove the fuel tank cap.
- Slowly pour fuel into the tank through the fuel strainer.
- Close the tank cap securely.

## Engine Oil

Check the engine oil daily before starting the engine otherwise shortage of the engine oil may cause serious damage to the engine such as seizure.

- Place the engine on level surface. Clean area around the oil filler cap (A) before removing it.
- Remove the oil filler cap and wipe the oil gauge (B) with clean cloth.
- Pour the oil slowly to “FULL” mark on the oil gauge.
- Insert the oil gauge into tube (C) WITHOUT SCREWING OIL FILLER CAP IN.
- Remove the oil filler cap to check the oil level. Level should be between “ADD” and “FULL” marks. Do not overfull.
- Install and tighten the oil filler cap.

### Engine Oil Capacity

FD731V	2.0 L (2.1 US-qt) [when oil filter is not removed]
	2.3 L (2.4 US-qt) [when oil filter is removed]

## 16 PREPARATION

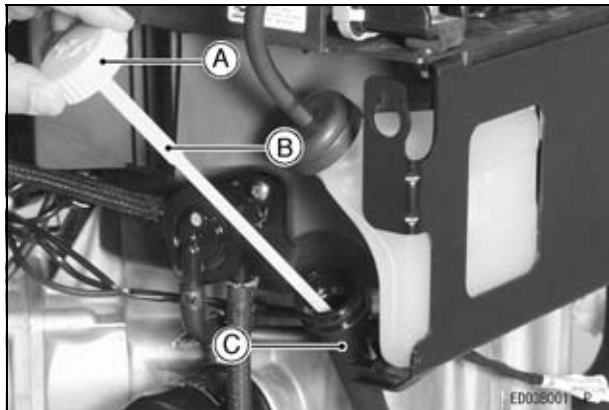

- A. Filler Cap
- B. Oil Gauge
- C. Tube

### CAUTION

Do not fill above the “FULL” mark. Excess oil will cause a smoking condition, and may cause the engine to overheat.

## Coolant

This engine is equipped with a highly efficient pressurized cooling system using a thermostat to maintain an optimum operating temperature. Coolant bypasses the closed thermostat when cold until operating temperature is attained, causing the engine to warm up more quickly. If the coolant temperature becomes too high, a thermo switch on the engine activates the coolant warning lamp to alert the operator of cooling problem.

### NOTE

- *Have the first original permanent type of antifreeze replenished by your authorized KAWASAKI Dealer.*

Check coolant level daily before starting the engine.

- Be sure the engine is level.
- Check the coolant level only at the overflow reservoir (A). The cooling system is a closed type. Never open the radiator cap. Doing so may induce air into the cooling system and may cause overheating.
- The coolant level should be between the “H” (H) and “L” (L) marks.

### NOTE

- *Check the level when the engine is cold (room or atmospheric temperature).*



- If the amount of coolant is insufficient, remove the cap (B) from the reservoir and add coolant to the “H” mark.
- Install the cap.

**Recommended Coolant Solution**

Coolant Mixture Ratio:

Water 50% : Antifreeze 50% (1 : 1)

Recommended Antifreeze:

Permanent type antifreeze (ethylene glycol plus corrosion and rust inhibitor chemicals for cast-iron engines and aluminum radiators)

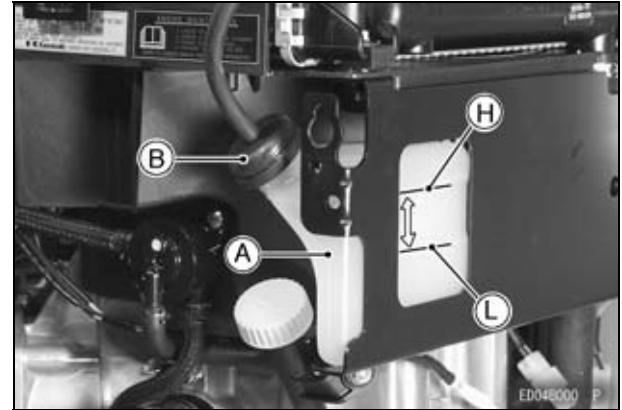

A. Over Flow Reservoir  
B. Reservoir Cap

# STARTING

## Start Engine

### ⚠ WARNING

Exhaust gases contain carbon monoxide, a colorless, odorless, poisonous gas. Do not operate the equipment in enclosed areas. Provide adequate ventilation at all times.

### ⚠ WARNING

Engine exhaust may ignite combustible materials and cause a fire. Keep the area around the exhaust outlet clear. Locate the equipment so that the exhaust outlet points toward an open area and is located at least one meter (3.3 feet) from any obstructions.



### NOTE

- Use proper oil for temperature expected (See FUEL AND OIL RECOMMENDATIONS chapter).
- Use fresh gasoline.
- Before starting the engine, insure all possible external loads are disconnected.

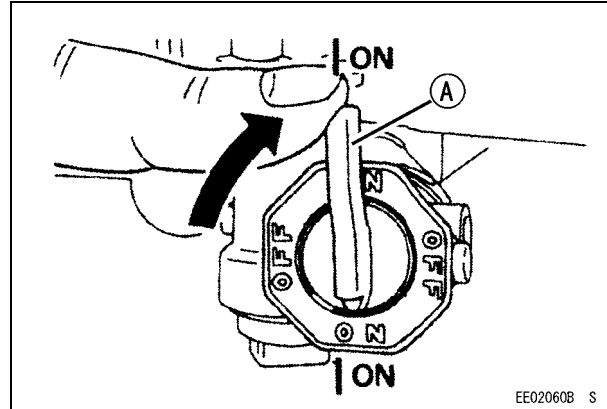
- Turn the fuel tap lever (A) on the equipment to “ON” (Open) position.



#### A. Fuel Tap Lever

- Move the throttle lever (A) on the equipment to its halfway position (between “ ” (FAST) and “ ” (SLOW) position).
- Turn the choke lever (B) on the equipment to “ ” (Close) position.

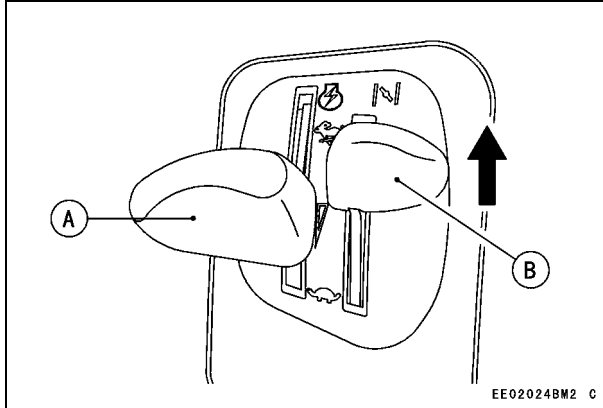

- A. Throttle Lever  
B. Choke Lever

### NOTE

- Use full choke when the engine is cold, but in hot weather or when the engine is already warm, use halfchoke or leave the choke fully open.
- Turn the switch key (A) to the START position on the equipment. Usually engine will start within 3 seconds.

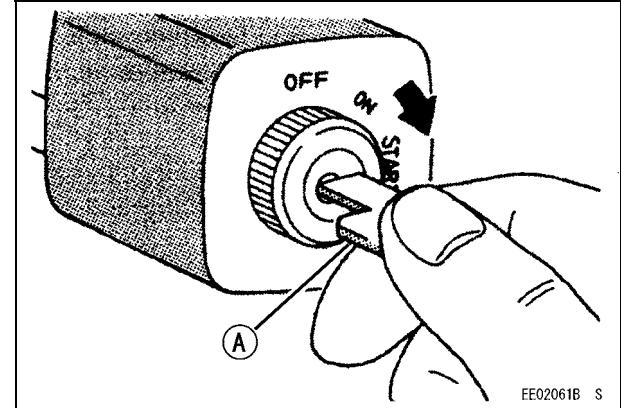

- A. Switch Key

### CAUTION

**Whenever you start engine, make sure warning light is not illuminated after engine starts. If warning light comes on, stop engine immediately and check oil level (if equipped).**

### NOTE

- When the engine is very warm, or when the engine does not start immediately, **DO NOT** keep trying to start it with the choke closed as this will cause flooding and make starting more difficult.
- Instead, fully open the choke and start the engine.

---

# OPERATING

---

---

## Warming Up

---

After the engine starts, gradually return the choke lever (A) to the “ ” (fully open) position.

To warm up the engine, run it for 3 to 5 minutes with the throttle lever (B) in the same position (halfway) before putting the equipment under load. Then, move the throttle lever to its “ ”: FAST position.

### CAUTION

**Allow engine to warm up sufficiently (3 to 5 minutes at idle) before applying a load. This will allow oil to reach all engine parts, and allow piston clearance to reach design specifications.**

### CAUTION

**While warming up the engine, make sure the warning lights (oil pressure, charging monitor, and coolant temperature and/or self-diagnosis light) on the dash are not on. These lights must not be illuminated during engine operation.**

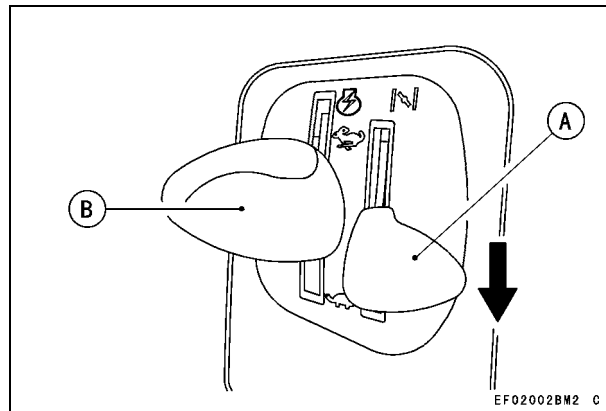

A. Choke Lever  
B. Throttle Lever

---

## Engine Inclination

---

This engine will operate continuously at angles up to 25° in any direction.

Refer to the operating instructions of the equipment this engine powers. Because of equipment design or application, there may be more stringent restrictions regarding the angle of operation.

### CAUTION

**Do not operate this engine continuously at angles exceeding 25° in any direction. Engine damage could result from insufficient lubrication.**

# STOPPING

## Ordinary Stop

- Move throttle lever (A) to “🐢”: (SLOW) position.
- Lower the engine speed to an idle. Keep running at idle for about one minute.

### CAUTION

**Engine damage can occur from run-on or after-burning if engine is stopped suddenly from high speed loaded operation. Reduce engine speed to idle for one minute before shutting engine off.**

- Turn the switch key to “OFF” position.
- Turn the fuel tap lever on the equipment to “OFF” (Close) position.

## Emergency Stop

- Immediately turn the switch key to “OFF” position.
- Turn the fuel tap lever on the equipment to “OFF” (Close) position.

### ⚠ WARNING

**Always remove switch key from switch when leaving equipment unattended or when equipment is not in use.**

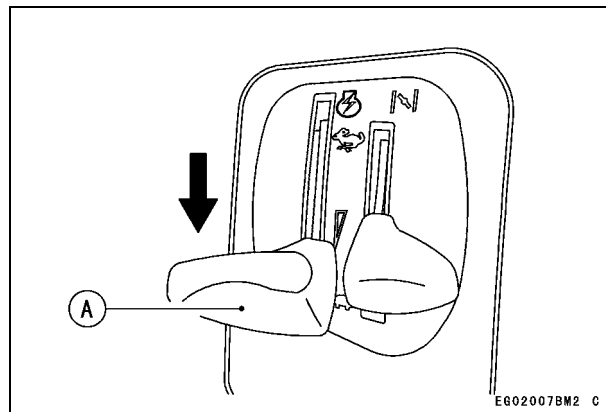

**A. Throttle Lever**

---



# ADJUSTMENT

---

---

## Throttle Cable Installation, Adjustment



---

- Link the throttle cable (G) to the speed control lever (C) and loosely clamp the throttle cable outer housing (F) with the cable clamp bolt (A).
- Move the throttle lever on the equipment to “  ” (FAST) ” position.
- Pull up the outer housing (F) of the throttle cable until the inner wire (G) has almost no slack, and tighten the cable clamp bolt (A).
- Move the throttle lever to “  ” (SLOW) position. Make sure that the carburetor throttle valve (H) is moved smoothly.

---

## Choke Cable Installation, Adjustment

---

- Link the choke cable (K) to the choke control lever (D), and loosely clamp the choke cable outer housing (L) with the cable clamp bolt (B).
- Move the equipment choke control to “  ” (OPEN) position. Make sure that the carburetor choke valve (M) is fully opened.
- Pull up the outer housing (L) of the choke cable until the inner wire (K) has almost no slack, and tighten the cable clamp bolt (B).
- Move the equipment choke control to “  ” (CHOKE) position. Make sure that the carburetor choke valve (M) is completely closed.
- Make sure that the choke valve turns from fully closed position to fully opened position when actuating the equipment choke control.

## 24 ADJUSTMENT

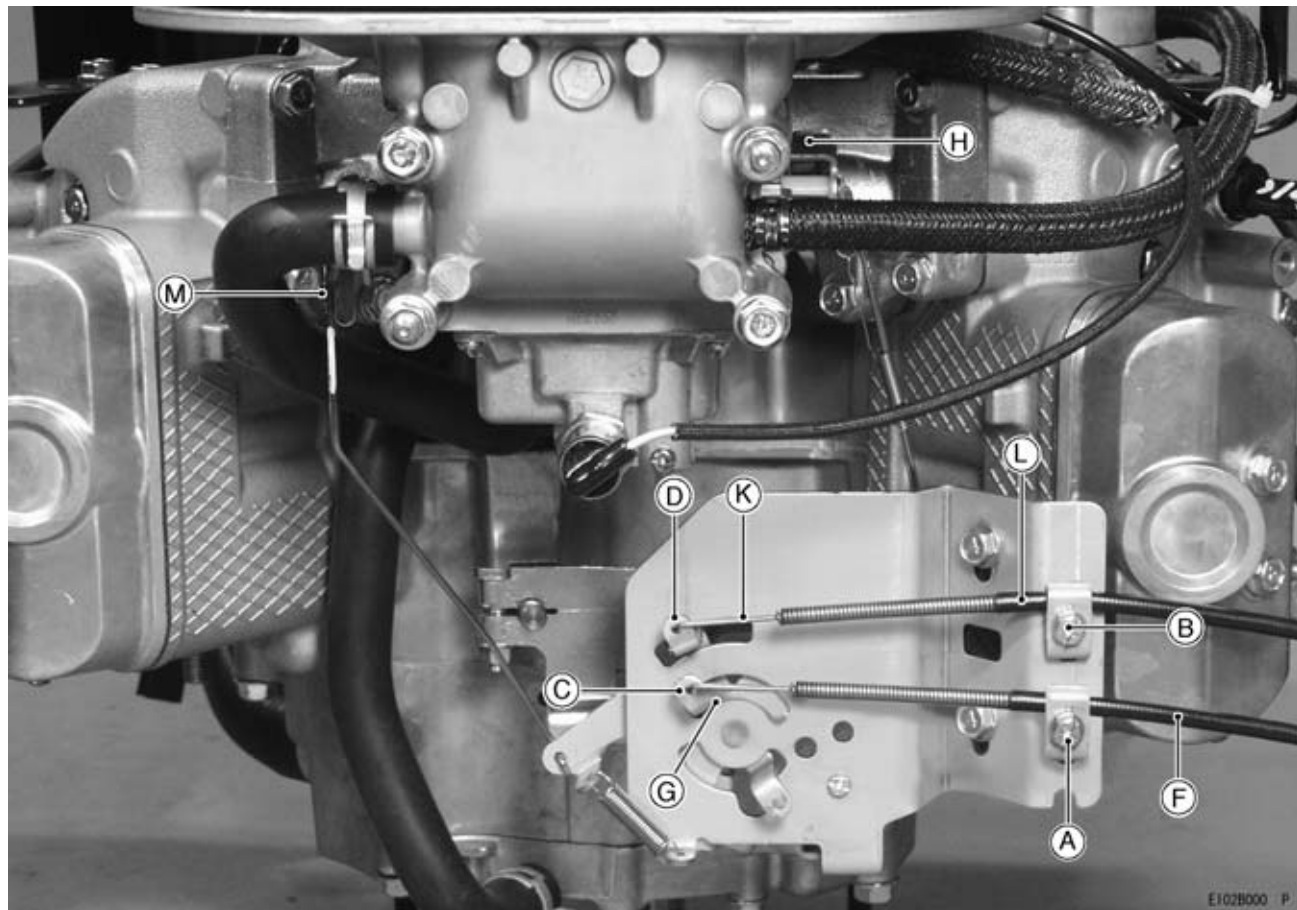



---

**Engine Speed Adjustment**

---

**NOTE**

- *Do not tamper with the governor setting, the carburetor setting to increase the engine speed. Every carburetor is adjusted at the factory and a cap or stop plate is installed on each mixture screw.*

- *If adjustment is needed, it must be performed by your authorized Kawasaki dealer.*



MAINTENANCE	INTERVAL								
	Daily	First 8 hr.	Every 25 hr.	Every 100 hr.	Every 200 hr.	Every 250 hr.	Every 300 hr.	Every 400 hr.	Every 500 hr.
Tighten bolts, nuts and screws			•						
★Clean air cleaner foam element, (Standard air cleaner model)			•						
★Replace air cleaner paper element, (Standard air cleaner model)				•					
Change engine oil		•		•					
Clean and regap spark plugs				•					
Inspect radiator and hoses leakage					•				
Change oil filter					•				
★Replace air cleaner primary element (Heavy duty air cleaner model)						•			
★Check air cleaner secondary element (Heavy duty air cleaner model)						•			
★Replace air clean secondary element (Heavy duty air cleaner model)									•
<b>K</b> Clean combustion chambers							•		
<b>K</b> Check and adjust valve clearance							•		

## 28 MAINTENANCE

MAINTENANCE	INTERVAL								
	Daily	First 8 hr.	Every 25 hr.	Every 100 hr.	Every 200 hr.	Every 250 hr.	Every 300 hr.	Every 400 hr.	Every 500 hr.
<b>K</b> Clean and lap valve seating surface							•		
<b>K</b> Inspect radiator and hoses					•				
<b>K</b> Change coolant								•	

★: Service more frequently under dusty conditions.

**K**: Have an authorized Kawasaki dealer perform these service.

---

## **Oil Level Check**

---

Check oil level daily and before each time of operation. Be sure oil level is maintained. (See “PREPARATION” chapter.)

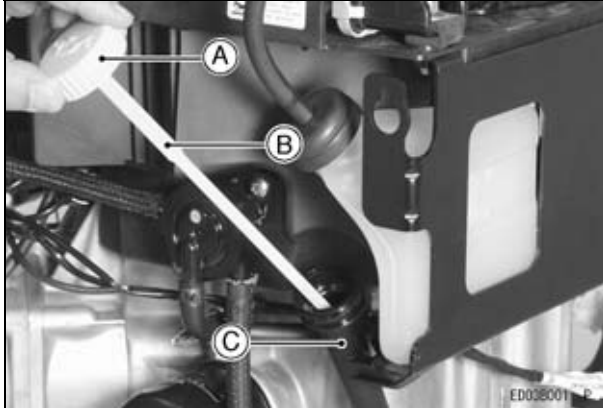

- A. Oil Filler Cap**
- B. Oil Gauge**
- C. Tube**

## **Engine Oil Capacity**

FD731V	2.0 L (2.1 US-qt) When oil filter is not removed.
	2.3 L (2.4 US-qt) When oil filter is not removed.

## 30 MAINTENANCE

### Oil Change

Change oil after first 8 hours of operation. Thereafter change oil every 100 hours.

- Run the engine to warm oil.
- Be sure the engine (equipment) is level.
- Stop the engine.
- Remove the oil drain plug (A) and drain the oil into suitable container while engine is warm.

#### **⚠ WARNING**

**Hot engine oil can cause severe burns. Allow engine temperature to drop from hot to warm level before draining and handling oil.**

- Install the oil drain plug.
- Remove oil gauge and refill with fresh oil (See “FUEL AND OIL RECOMMENDATIONS” chapter).
- Check the oil level (see “PREPARATION” chapter for oil level check).

#### **⚠ WARNING**

**Engine oil is a toxic substance. Dispose of used oil properly. Contact your local authorities for approved disposal methods or possible recycling.**

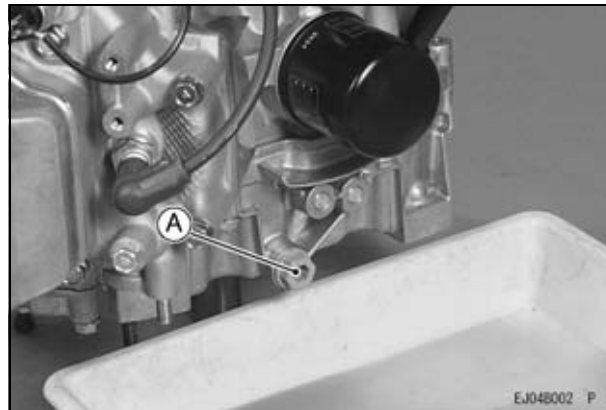

A. Oil Drain Plug

## Oil Filter Change

- Change the oil filter every 200 hours of operation.

### **⚠ WARNING**

**Hot engine oil can cause severe burns. Allow engine temperature to drop from hot to warm level before attempting to remove oil filter.**

- Drain engine oil into a suitable container.

### **CAUTION**

**Before removing the oil filter, place suitable pan under filter connection.**

- Rotate the oil filter (A) counterclockwise to remove it.
- Coat a film of clean engine oil on seal of new filter.
- Install new filter rotating it clockwise until seal contacts mounting surface (B). Then rotate filter 3/4 turn more by hand.
- Supply engine oil as specified.
- Run the engine for about 3 minutes, stop engine, and check oil leakage around the filter.
- Add oil to compensate for oil level drop due to oil filter capacity (See “PREPARATION” chapter for oil level check).



A. Oil Filter  
B. Mounting Surface

### **⚠ WARNING**

**Engine oil is a toxic substance. Dispose of used oil properly. Contact your local authorities for approved disposal methods or possible recycling.**

## 32 MAINTENANCE

### Cooling System Inspection

#### **⚠ WARNING**

**Never handle the radiator cap when the engine is still hot. Engine coolant is hot and under pressure and can cause severe burns. Wait until it cools down.**

Inspect the radiator and the hoses every 200 hours of operation.

- Inspect the coolant hoses (A), (B) and (C) for cracks or deterioration, and connections for looseness. Replace any damaged hose with a new one.
- Check for dirt and insects that may be lodged in the radiator (D) and the screen of the radiator. Clean them out by using compressed air or a low-pressure washer.

#### **CAUTION**

**Using high-pressure water, as from a car wash facility, could damage the radiator fins and impair the radiator's effectiveness. Do not run engine before all cooling system parts are reinstalled to keep cooling and carburetion as intended.**

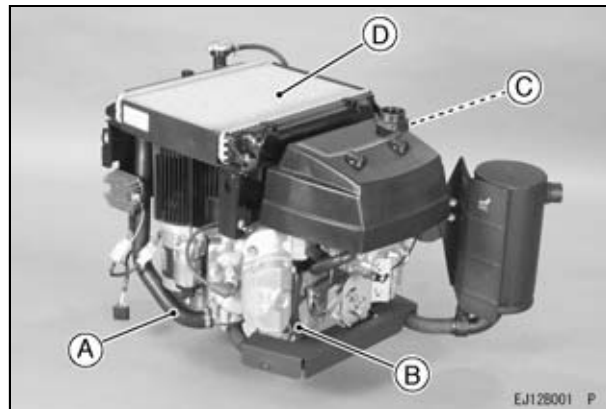

- A. Inlet Hose**
- B. Bypass Hose**
- C. Outlet Hose**
- D. Radiator**



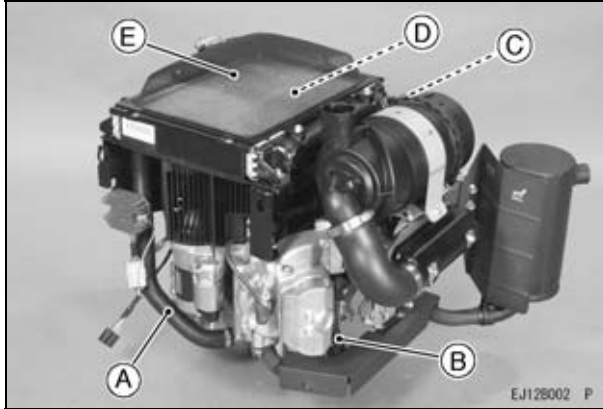

- A. Inlet Hose
- B. Bypass Hose
- C. Outlet Hose
- D. Radiator
- E. Screen of Radiator

**⚠ WARNING**

Coolant is a toxic substance. Dispose of used coolant properly. Contact your local authorities for approved disposal methods.

## Air Cleaner Service

### Standard Air Cleaner Type

**CAUTION**

Improper installing the air cleaner parts can result in engine damage.

**CAUTION**

To prevent excessive engine wear, do not run the engine with the air cleaner parts removed.

- Remove the air cleaner case (A) from the inlet pipe (B) by unscrewing the nuts (C) counterclockwise.
- Remove the air cleaner foam element (D) and the paper element (E) from the inlet pipe by unscrewing the wing nuts (F) counterclockwise.
- Reinstall the cleaned or new air cleaner parts in the reverse of removal.

### Foam Element

Clean the foam element (D) every 25 hours.

- Wash the element in detergent and water, and dry it thoroughly.

### Paper Element

- Clean the paper element by tapping it gently on a flat surface to remove dust. If the element is very dirty, replace the paper element with a new one.

## 34 MAINTENANCE

Replace with a new paper element yearly or 100 hours, whichever comes first.

### NOTE

○ *Operating in dusty condition may require more frequent maintenance than above.*

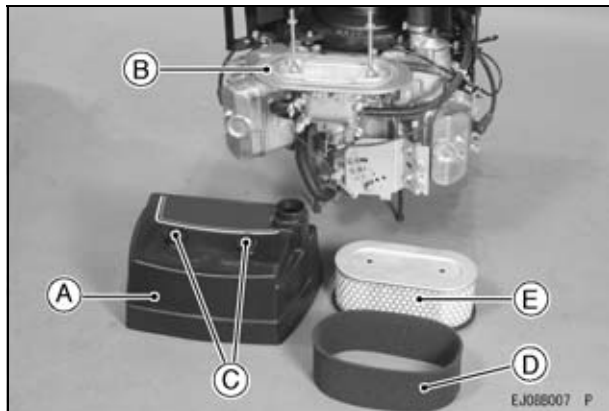

- A. Air Cleaner Case
- B. Inlet Pipe
- C. Nut
- D. Foam Element
- E. Paper Element

## CAUTION

**Do not use petroleum solvent to clean paper-element.**  
**Do not oil foam or paper element.**  
**Do not use pressurized air to clean or dry paper-element.**

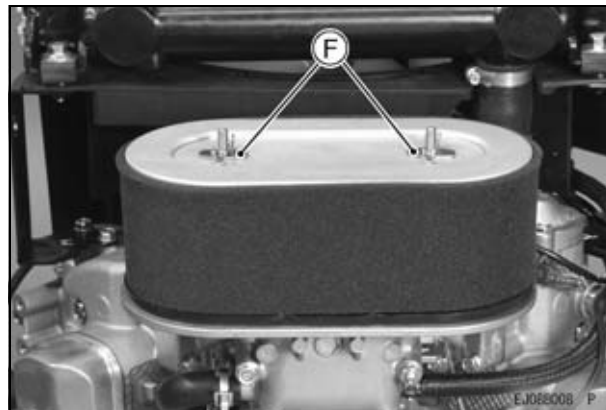

F. Wing Nuts

### Heavy Duty Air Cleaner Type

This air cleaner elements are not recommended to be cleaned, and each air cleaner element should be replaced with the new one at the maintenance time as shown in the maintenance chart.

**CAUTION**

**Improper installing the air cleaner parts can result in engine damage.**

**CAUTION**

**To prevent excessive engine wear, do not run the engine with the air cleaner parts removed.**

- Unfasten the two retaining clamps (A) and remove the case (B) from the air cleaner body (C).
- Remove the primary element (D) and the secondary element (E) from the air cleaner body by pulling out them.
- Install the new air cleaner elements into the air cleaner body.
- Reinstall the case with the cap (F) is down and securely fasten the two retaining clamps.

**Primary Element**

Replace the primary element every 250 hrs.

**Secondary Element**

Replace the primary element every 500 hrs.

Replace the secondary element with the new one if dirty when primary element is checked.

**Cap (Dust Ejector Valve)**

Push open the cap on the case of the air cleaner body to expel dust and/or water accumulated inside.

**NOTE**

- *Operating in dusty condition may require more frequent maintenance than above.*

**CAUTION**

**Do not wash air cleaner elements.  
Do not oil air cleaner elements.  
Do not use pressurized air to clean air cleaner elements.**

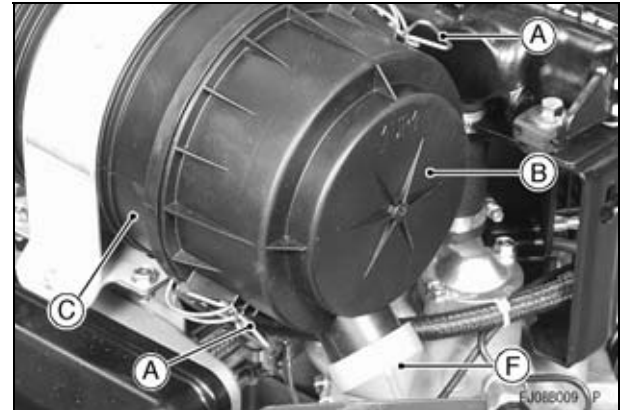

- A. Retaining Clamps**
- B. Case**
- C. Air Cleaner Body**
- F. Cap (Dust Ejector Valve)**

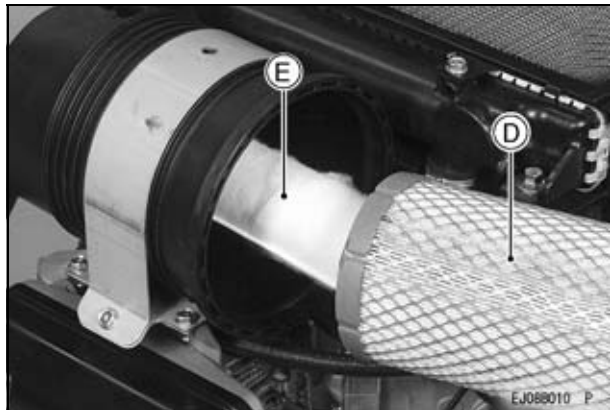

D. Primary Element  
E. Secondary Element

---

## Fuel Filter and Fuel Pump Service

---

### **WARNING**

Improper use of solvents can result in fire or an explosion.

Do not use gasoline or low flash-point solvents to clean the fuel filter and/or the fuel pump.

Clean only in a well ventilated area away from sources of sparks or flame, including any appliances with a pilot light.

- The fuel filter and the fuel pump can not be disassembled.  
If these parts failed contact Kawasaki dealer.

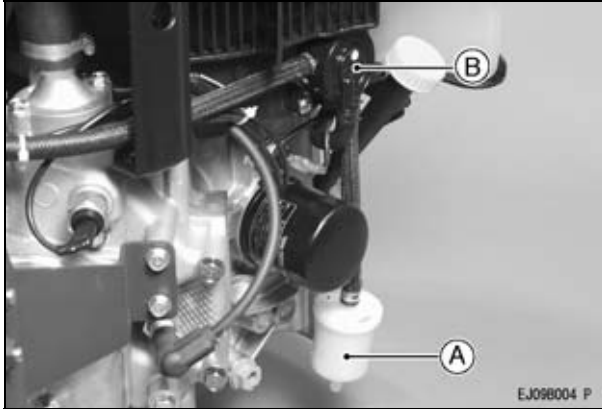

**A. Fuel Filter**  
**B. Fuel Pump**

## Spark Plug Service

### **⚠ WARNING**

**Hot engine components can cause severe burns.  
Stop engine and allow it to cool before checking spark plugs.**

Clean or replace the spark plugs and reset gap (A) every 100 hours of operation.

- Disconnect the spark plug caps and remove the spark plugs.
- Clean the electrodes (B) by scraping with a wire brush to remove carbon deposits.
- Inspect for cracked porcelain or other wear and damage. Replace the spark plugs with a new one if necessary.
- Check the spark plug gap and reset it if necessary. The gap must be 0.75 mm (0.030 in). To change the gap, bend only the side-electrode, using a spark plug tool.
- Install and tighten the spark plug to 25 N·m (2.5 kgf·m, 18 ft·lb).
- Fit the spark plug caps on the spark plug securely.
- Pull up the spark plug caps lightly to make sure of the installation of the spark plug caps.

## 38 MAINTENANCE

### RECOMMENDED SPARK PLUG

NGK BPR4ES

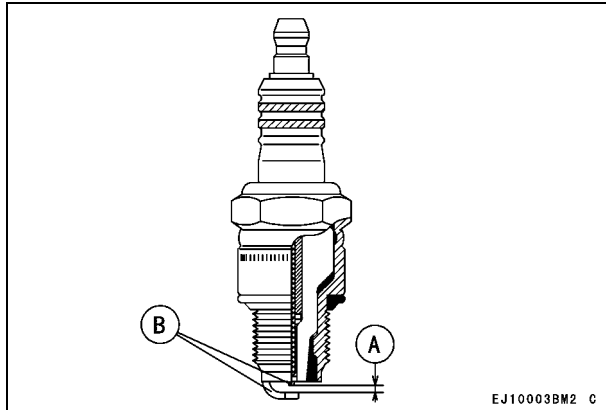

EJ10003BM2 C

- A. Spark Plug Gap
- B. Electrodes

# STORAGE

## Fuel System Draining

Engine to be stored over 30 days should be completely drained of fuel to prevent the deterioration of fuel and the gum deposits forming on essential fuel system parts, fuel filter and fuel tank.

### **⚠ WARNING**

**Gasoline is extremely flammable and can be explosive under certain conditions. Drain fuel before storing the unit for extended periods. Drain fuel in a well-ventilated area away from any source of flame or sparks, including any appliances with a pilot light. Store fuel in an approved container in safe location.**

- Clean every part of the engine.
- Be sure that the engine switch or switch key is positioned at "OFF".
- Close the fuel valve and remove the sediment bowl.
- Put a pan under the fuel valve to receive the drained fuel, and open the fuel valve to drain the fuel from fuel tank completely.
- Install the sediment bowl.
- Put a suitable pan under the carburetor (B) and loosen the drain screw (A) of the carburetor to drain the fuel completely.

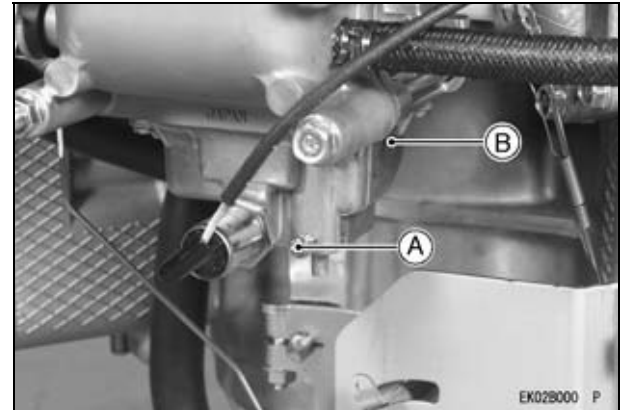

A. Fuel Drain Screw  
B. Carburetor

- Tighten the fuel drain screw.

### **⚠ WARNING**

**Gasoline is a toxic substance. Dispose of gasoline properly. Contact your local authorities for approved disposal methods.**

- Remove the spark plugs and pour approx 1 ~ 2 mL (0.06 ~ 0.1 cu. in.) of engine oil through the spark plug holes (A) and then screw the spark plugs. Turn the switch key to the "START" position for a few seconds. This traps the air inside the cylinders and prevents rust inside the engine.

## 40 STORAGE

- Fit the spark plug caps on the spark plugs securely.
- Pull up the spark plug caps lightly to make sure of the installation of the spark plug caps.
- Wipe the body with oily cloth.
- Change engine oil for next use after period of storage (Refer to “Oil change” section in “MAINTENANCE” chapter).

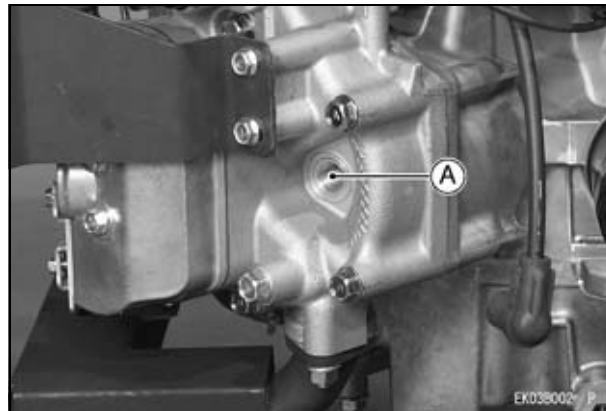

A. Spark Plug Hole



# TROUBLESHOOTING GUIDE

If the engine malfunctions, carefully examine the symptoms and the operating conditions, and use the table below as a guide to troubleshooting.

Symptom		Probable Cause	Remedy
Engine won't start or output is low	Insufficient compression	Faulty pistons, cylinders, piston rings, and head gaskets	<b>K</b>
		Faulty valves	
		Loose spark plugs	Tighten properly
		Loose cylinder head bolts	
	No fuel to combustion chambers	No fuel in fuel tank	Fill fuel tank
		Fuel tap lever not in "ON" position	Turn fuel tap lever to "ON" (Open) position.
		Blocked fuel filter or tube	Clean
		Blocked air vent in tank cap	
		Faulty carburetor	<b>K</b>
	Spark plugs fouled by fuel	Over-rich fuel/air mixture	Turn choke lever to the "  " (Open) position.
			Rotate engine with spark plugs removed to discharge excess fuel.
			Clean spark plugs.
		Clogged air cleaner element	Clean element (Standard air cleaner type) Replace element (Heavy duty air cleaner type)
		Faulty carburetor	<b>K</b>
Incorrect grade/type of fuel		Change fuel	
Water in fuel			

## 42 TROUBLESHOOTING GUIDE

Symptom		Probable Cause	Remedy
	No spark or weak spark	Faulty spark plugs	Replace spark plugs
		Faulty ignition coils	<b>K</b>
Low output	Engine overheats	Clogged air cleaner	Clean element (Standard air cleaner type) Replace element (Heavy duty air cleaner type)
		Lodged dirt and insects in radiator	Clean
		Lack of coolant	Add coolant to correct level
		Insufficient engine oil	Replenish or change oil
		Carbon build-up in combustion chamber	<b>K</b>
		Poor ventilation around engine	Select a better location
	Engine speed won't increase	Faulty governor	<b>K</b>

**K** : Have an authorized Kawasaki dealer perform these service.

---

## ENVIRONMENTAL PROTECTION

---

To protect our environment, properly discard used batteries, engine oil, gasoline, coolant, or other components that you might dispose of in the future.

Consult your authorized Kawasaki dealer or local environmental waste agency for their proper disposal procedure.

---

## SPECIFICATIONS

---

	FD731V
Type of engine	Liquid– cooled, 4–stroke OHV, V-twin cylinder, gasoline engine
Bore × Stroke	75.2 × 76 mm (2.96 × 2.99 in.)
Displacement	675 mL (41.2 cu.in)
Ignition System	Solid–state ignition
Direction of rotation	Counterclockwise facing the PTO Shaft
Starting system	Electric starter
Dry weight : kg (lbs)	45 kg (99.2 lbs)

### NOTE

- *Specifications subject to change without notice.*
- *Dry weight: with standard air cleaner, and with out muffler.*

# WIRING DIAGRAM

## Wiring Diagram

