



ZT
MODEL



©2012 12-11

ZERO-TURN MOWER OWNER'S, SERVICE & PARTS MANUAL

For additional information, please see us at
www.badboymowers.com

Bad Boy, Inc.
102 Industrial Drive
Batesville, Arkansas 72501
(870) 698-0090

TABLE OF CONTENTS

Basic Information.....	Section 1 (pages 4–5)
Bad Boy Safety Guidelines	Section 2 (pages 5–6)
Operation	Section 3 (pages 6–7)
Maintenance	Section 4 (page 7)
Storage and Transportation	Section 5 (page 8)
Troubleshooting and FAQ.....	Section 6 (pages 8–9)
Controls	Section 7 (page 9)
Moving Inoperable Mower	Section 8 (page 10)
Instrumentation	Section 9 (page 10)
Mower Blade Maintenance.....	Section 10 (page 11)
Greasing Bearings.....	Section 11 (pages 11)
How to choose the right blade	Page 12
Mowing Tips	Page 21

SERVICE SECTION BEGINS ON PAGE 13
PARTS SECTION BEGINS ON PAGE 22
LIMITED WARRANTY PAGE 42



This manual applies to the following equipment:

Bad Boy ZT Series

ZT 2600 50" 26/27 hp Briggs ELS

ZT 2700 50" 27 hp Kohler

ZT 2700 60" 27 hp Kohler

ZT 2700 50" 726cc Kawasaki

ZT 2700 60" 726cc Kawasaki

COMMONLY USED ITEMS AND PART NUMBERS

60" ZT Blade	Hi-Lift Fusion 038-6060-00	Gator Blade 038-6003-00	Wave Blade 038-6015-00
50" ZT Blade	Hi-Lift Fusion 038-5350-00	Gator Blade 038-5000-00	Wave Blade 038-4825-00
ZT Hydro Filters	063-1050-00		
60" ZT Deck Belt	041-1650-00		
50" ZT Deck Belt	041-1470-00		
ZT Pump Belt	041-6400-00		
Oil Filter	Briggs Engine 063-2004-00	Kohler Engine 063-5400-00	
Air Filter	Briggs Engine 063-4000-00	Kohler Engine 063-8080-00	
Motor Oil	10w30 (2 quarts)		
Hydro Oil	20w50 (4 quarts)		

SECTION 1: BASIC INFORMATION

Congratulations on the purchase of your new Bad Boy Mower! The purpose of this manual is to assist operators in maintaining and operating their machine. The information and instructions in this manual can help you attain years of performance from your new Bad Boy. Also, check out our website to learn more about the Bad Boy family.

- 1.1 All Bad Boy engines use 10W30 engine oil. Conventional or Synthetic may be used.
- 1.2 All Bad Boy hydraulic systems use 20W50 engine oil. Conventional or Synthetic may be used.
- 1.3 All Bad Boy Mowers use hi-temp multi-purpose grease. NLGI No. 2 for the grease fittings.
- 1.4 ZT models have 12 psi in both front and rear tires.
- 1.5 Most Briggs, Kohler, Kawasaki, and Vanguard engines hold two (2) quarts of motor oil.

Warranty Registration

The Warranty Registration form must be completed and signed to validate your warranty. As the new equipment owner, you are expected to see that the form is completed and forwarded to Bad Boy, Inc., at time of delivery. Warranty is non transferable.

Model/Serial Number

Your ZT model serial numbers are found on the SIN plate underneath seat. The serial numbers are necessary on the warranty registration form. Also, these numbers can assist you in the ordering of new parts when replacements become necessary.

Parts/Service

Only Bad Boy replacement parts are to be used on your mower.

Replacement parts are available through your local Bad Boy Mower Dealer. Remember to always provide the following information when ordering parts:

1. Correct part number
2. Correct serial number

All warranty repair and service must be handled through your authorized Bad Boy Mowers dealer. To locate the nearest dealer, go to our website and click on Locate a Dealer.



SECTION 2: MOWER SAFETY GUIDELINES

Never allow untrained people to operate this machine. It is the owner's responsibility to get training and see to it that anyone who has permission to use your machine receives the proper training.

Do not mow around people. The factory discharge chute is designed to deflect debris downward, but it could be possible for debris to be thrown in a way that can cause damage to people or property.

Seek additional training when possible to learn more about safety techniques and practices.

SAFETY PRECAUTIONS

- 2.2 Always remain seated while operating machine.
- 2.3 Always maintain a safe distance from people and pets while mowing.
- 2.4 Always disengage blades, place steering controls in neutral, engage parking brake, and remove ignition key when leaving operators seat.
- 2.5 Always operate machine in daylight or with adequate working lights.
- 2.6 Be alert of surroundings. Watch for rocks, stumps, and mounds or depressions while mowing.
- 2.7 Always wear eye protection while mowing and servicing.
- 2.8 Always wear ear protection, such as earplugs, while mowing.
- 2.9 If you strike something with the mower turn the blades and mower off, engage the parking brake, and inspect the machine for damage before resuming.
- 2.10 Be aware of low hanging limbs or objects that could potentially be hazardous while mowing.
- 2.11 Never operate a poorly maintained machine.
- 2.12 Never carry passengers.
- 2.13 Always buckle seat belt, if provided one.
- 2.14 Never attempt high speed maneuvering, especially around people or property.
- 2.15 Never put hands or feet under the machine while ignition is on.
- 2.16 Never refuel machine when engine is running.
- 2.17 Never leave key in ignition, especially around children.
- 2.18 Never run engine in enclosed area.
- 2.19 Do not touch hot parts of machine.
- 2.20 Do not remove deck wheels.
- 2.21 Conditions that can affect traction resulting in the loss of control of machine: Wet terrain, Hills or extreme angles, Depressions in the ground, Mounds of dirt, Extremely dry grass, Soil type (gravel, sand, clay), Tire pressure
- 2.22 Be aware of what is located at the bottom of slopes. For example, Rocks, Water, Cliffs, Roads and Highways

2.23 Safety warning decals are located on the mower and should always be observed and followed.

- 2.24 Never operate the mower with the discharge chute open.
- 2.25 Prevent Fires—Remove grass and debris from engine compartment and muffler area, before and after operating machine, especially after mowing or mulching in dry conditions.
- 2.26 Do not store machine near open flame or source of ignition, such as a water heater or furnace.
- 2.27 Do not attempt to mount a tire without the proper equipment and experience to perform the job.
- 2.28 Always maintain the correct tire pressure. Do not inflate the tires above the recommended pressure. Never weld or heat a wheel and tire assembly. The heat can cause an increase in air pressure resulting in a tire explosion. Welding can structurally weaken or deform the wheel.
- 2.29 Never operate machine in a closed area where dangerous carbon monoxide fumes can collect.
- 2.30 Let engine cool before storing!!!
- 2.31 Hydraulic hoses and lines can fail due to physical damage, kinks, age, and exposure. Check hoses and lines regularly. Replace damaged hoses and lines.
- 2.32 Park machine on level ground. Never allow untrained personnel to service machine. Understand service procedure before doing work.

SECTION 3: MOWER OPERATION

Never operate the machine with faulty equipment. Always be alert of sudden changes in landscape, as the mower will react differently on slopes or embankments than it will on flat surfaces. Never operate the mower with the discharge chute open. Do not cross terrain, other than grass, with blades turning. This could cause damage to property or bystanders.

- 3.1 Place parking brake in up position
- 3.2 Drive arms must be in the “open” position. While sitting on the machine, each arm is positioned away from the operator, to the right and left. Drive arms will lock into place and must be in this position to start machine.
- 3.3 Put PTO switch in the OFF position.
- 3.4 If your machine has been equipped with a ROPS (Roll Over Protection System) then you must fasten seatbelt.
- 3.5 If machine has not been started recently, engage the choke.
- 3.6 Make sure nothing is under or around machine.
- 3.7 Place key in ignition and turn.
- 3.8 Once machine is started, disengage the choke.



- 3.9 Increase RPM by sliding the throttle to fast position, toward the rabbit.
- 3.10 Owners must become familiar with the controls before operating a zero-turn radius vehicle.
- 3.11 Start slowly and build your skill level. Have ample practice before using the machine at full capabilities.
- 3.12 Be comfortable with machine before engaging blades. Know what each component controls before using machine.
- 3.13 Your mower will perform differently on an incline /decline. Be cautious, slow down, and do not make any sudden jerking movements with control arms. The machine could lose traction on a decline or tip backwards on an incline.
- 3.14 Once you become comfortable with your Bad Boy Mower you will notice your overall mowing time will decrease.

Avoid operating your mower on side hills of over 5 degrees, inclines of over 10 degrees, and declines of over 15 degrees.

SECTION 4: MOWER MAINTENANCE

*****Check each and provide maintenance when needed.***

DAILY

- 4.1 Check Engine Oil
- 4.2 Check Engine Air Filter
- 4.3 Tire Pressure
- 4.4 Inspect Blades

Within FIRST five hours of usage, change engine oil and filter

EVERY 30 HOURS OF USAGE

- 4.5 Grease Machine

EVERY 50 HOURS OF USAGE

- 4.6 Change Engine Oil and Filters

Check filters once a year if under 50 hours

Check air and fuel filters more often in dry, dusty conditions

Within FIRST 50 hours of usage, change hydraulic oil and filters

EVERY 250 HOURS OF USAGE

- 4.7 Change Hydraulic Fluid and Filters
- 4.8 Refer to manufacturer manual for specific information on maintenance schedules.

SECTION 5: MOWER STORAGE & TRANSPORTATION

- 5.1 Keep machine from collecting debris by storing in a covered area while not in use.
- 5.2 Fuel can harm your machine if left for more than 30 days without changing, especially if the fuel contains ethanol. Never use fuel with more than 10% ethanol by volume. E-15 is not permitted.
- 5.3 Disconnect the negative battery cable when machine will be stored for more than 30 days.
- 5.4 Always secure machine properly when transporting machine.
- 5.5 Do not load machine on trailer with blades engaged.
- 5.6 Do not use ramps to load the machine.
- 5.7 Make sure Parking Brake is in “up” position.
- 5.8 In wet conditions tires may spin while loading / unloading. If necessary, wait for dry conditions before loading / unloading.
- 5.9 Make sure mode of transportation is suitable to bear the weight of mower.
- 5.10 Deck height should be set at maximum before attempting to load.
- 5.11 Secure mower with at least two straps capable of securing weight of mower.

SECTION 6: TROUBLESHOOTING

- 6.1 **Q: *How do I prevent an uneven cutting pattern and increase the quality of cut?***
- 6.1 **A:** Check tire pressure, check blade sharpness (replace blades or sharpen at least once per year or when needed), make sure blades are tightened properly, check spring and belt tension, check the underside of the deck to ensure the mower deck is free of grass build-up and debris, make sure your machine is at full throttle, and vary your mowing pattern each time you cut your grass.
- 6.2 **Q: *What should I do if my mower won't start?***
- 6.2 **A:** Check battery charge and connection (grounds), check your fuel (make sure fuel is less than 30 days old and contains no water), make sure your spark plug is in good condition and spark plug wire is attached, and make sure air filter is clean (a dirty filter makes it more difficult for the engine to draw air). Check for broken wires or bad connections.
- 6.3 **Q: *What should I do if the blades won't engage?***
- 6.3 **A:** Make sure the safety switch is plugged in on the bottom of seat. Check the underside of the PTO engager to ensure the plug is secure at switch.
- 6.4 **Q: *What type of fuel is recommended for my mower?***
- 6.4 **A:** We recommend that you use a name brand fuel to ensure quality. Use fuel with an octane rating near 87. Higher octane fuels offer no benefit. Only fuels with an ethanol content of 10% or less may be used. E-15 is not permitted.



6.5 **Q: Do you offer touch-up paint for your mowers?**

6.5 **A:** Touch-up paint is available. Contact your local dealer for more information.

6.6 **Q: How durable is the electric deck lift?**

6.6 **A:** The actuator which controls the deck height is designed for moving loads of up to 1000 pounds and has a static holding capability which exceeds 3,000 pounds. Our 1/4" deck weighs approximately 250 pounds which is only 25% of working capability.

SECTION 7: CONTROLS

7.1 **Ignition Switch**—Bad Boy Mowers have a three position ignition switch: off, run, and start. With key inserted, rotate it clockwise to START position and release key when engine starts, and switch will automatically return to the RUN position.

7.2 **Throttle Control**—A cable is connected to the engine throttle for controlling engine speed. Move lever forward to increase engine rpm, move lever backward to decrease engine rpm.

7.3 **Choke Control**—A cable is linked to manually operate the engine choke. When the lever is in the down position, the choke is in the off (run) position. When the lever is pulled up, the choke is in the on (start) position. Do not operate the machine in the on (start) position. The choke lever is behind the throttle control.

7.4 **Control Levers**—These levers control the mower's speed, direction, and neutral lock. These levers are used to steer, accelerate, decelerate and change direction. (Drive Arms)

7.5 **Blade Engage Switch**—This switch engages the blades. Pull the switch up to engage the blades and push the switch down to disengage the blades.

7.6 **Deck Lift Control**—The deck lift switch is used to raise and lower the deck. Pull the switch backwards to raise the deck and push the switch forward to lower the deck.

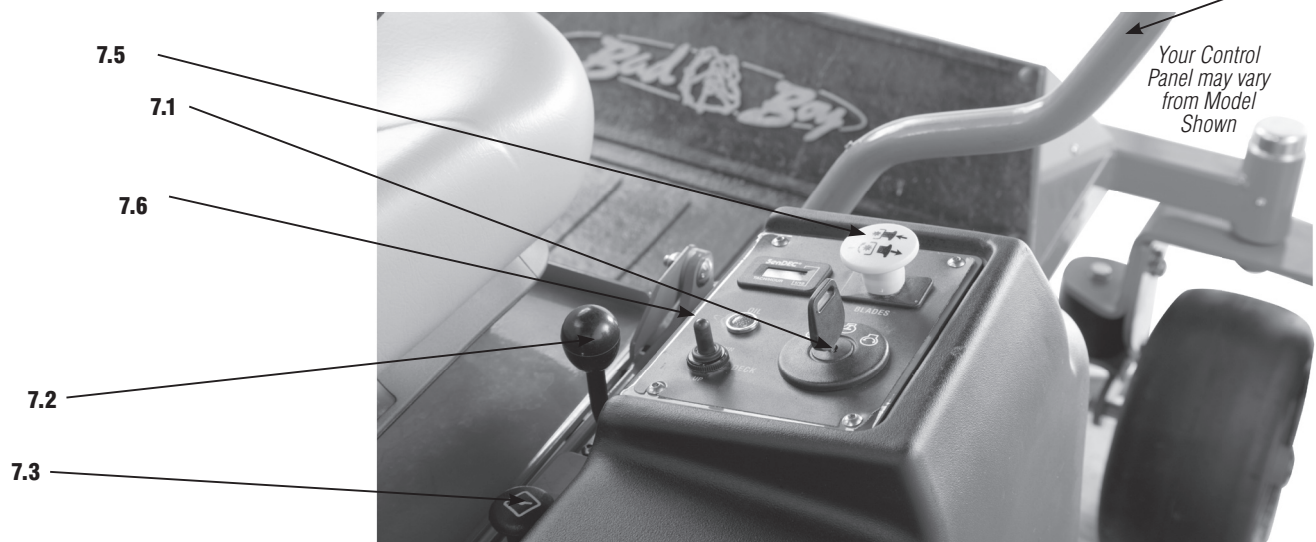

SECTION 8: MOVING INOPERABLE MOWER

- 8.1 Do not tow machine. Use a winch to load on a trailer for transporting.
- 8.2 **ATTENTION:** RETURN BYPASS VALVES TO OPERATING POSITION BEFORE RUNNING MOWER FOLLOWING REPAIRS.
- 8.3 ZT Models are equipped with two neutral engage/disengage arms, located at the rear of the mower protruding from the frame and under the muffler. By pulling the arms out the mower can be put in a neutral position. Return the arms to the “forward position for normal operation.
- 8.4 Your Bad Boy Mower Weighs: **ZT SERIES:** **800—850 lbs**
**** Weights fluctuate with the addition of accessories.*
- 8.5 As you can see by the weights of the machines, you shouldn’t ever try to push or pull a Bad Boy Mower by hand. This could cause serious bodily injury.
- 8.6 Hopefully, you’ll never need to use this section of the manual. However, if you do, use extreme caution when moving machine!

SECTION 9: INSTRUMENTATION

- 9.1 **Electronic Hour Meter**—Registers Hour increments up to 9,999.9 total hours. This meter records the cumulative time the engine is running.



SECTION 10: MOWER BLADE MAINTENANCE

- 10.1 Check mower blades after each use. This is essential for maintaining well-groomed turf. Keep the blades sharp. If a dull blade is used for cutting, the grass will tear rather than cut. This could damage the grass leaving a brown frayed top on the grass within a few hours. A dull blade will also require more power from the engine.
- 10.2 NEVER attempt to straighten a bent blade by heating. NEVER attempt to weld a cracked blade. The blades can break and cause serious injury or death.
- 10.3 NEVER work with blades while engine is running or deck clutch is engaged.
- 10.4 ALWAYS place deck clutch in DISENGAGE position while performing maintenance.
- 10.5 Use blocks when you MUST work under mower.
- 10.6 ALWAYS wear thick gloves when handling blades.
- 10.7 ALWAYS check for blade damage if mower strikes rock, branch, or other objects that could potentially damage the blade. **(REMEMBER: NEVER CHECK BLADE WHILE ENGINE IS ON! NEVER CHECK BLADES WHILE BLADES ARE ENGAGED!)**

SECTION 11: GREASING THE BEARINGS

- 11.1 Park the machine on a level surface and disengage the blade control switch.
- 11.2 Move the motion control levers outward to the neutral position, engage parking brake, stop the engine, remove the key, and wait for all moving parts to stop before leaving the operating position.
- 11.3 Grease Type: NLGI grade #2 multi-purpose gun grease. Grease the front cater pivots.
- 11.4 Clean the grease fittings with a cloth. Scrape any paint off the front of the fitting(s).
- 11.5 Connect a grease gun to each fitting. Pump grease in fittings until greases begins to seep out of the bearings. Wipe up excess grease.
- 11.6 Refer to service manual section for grease fitting locations.

HOW TO CHOOSE THE RIGHT BLADE

Essentially there are only TWO basic styles of mowing blades used or approved for use on our current products:

- 1) The standard style of mowing blade is essentially designed for cutting grass and effectively discharging the clippings out from the deck to fall onto the lawn or to be captured in a grass collection system. Standard blades are also referred to as “2-in-1” (discharging & bagging) or “high-lift” blades (because they are designed to create a higher-lifting airflow).
- 2) Mulching blades generally have a more curved style surface and frequently include extra cutting surfaces along the blade edges. These blades may also come in a “+” design (which is actually two individual blades arranged in a perpendicular fashion to enhance mulching). The “+” blades are usually found on older style mowers; newer ones utilize blades with more advanced mulching technology. Mulching blades may also be referred to as “3-in-1” (mulching, discharging & bagging) or “all-purpose” blades.

Bear in mind that the re-circulating airflow design of 3/1 blades makes them less efficient at discharging grass clippings than a standard 2/1 blade. As with most all-purpose tools, there is some give and take as opposed to using a tool designed for a more specific purpose.

If you’re experiencing less-than-desired cutting or discharging performance with a 3/1 blade, you may want to check into using a 2/1 blade. Conversely, if you’re using a 2/1 blade and want to mulch clippings, you should see about the availability of mulching blades or a mulching kit.*

The type of blade installed on a new mower is a decision the retailer makes for each model of mower, based on the expected needs of most customers. If you’re unsure of which blade is on a particular model, inspect the blade. Blades have part numbers stamped into them. Then compare these part numbers with the unit’s Operator’s Manual or Parts List.

It is true there are many other styles of blades available. But since we don’t manufacture or recommend using these other aftermarket styles, we will leave them out of this discussion. Should you want more information on special application or aftermarket blades, you should contact the companies that make these products. NOTE: Customers using non-OEM blades do so at their own risk. The use of unapproved (non-OEM) blades may void any or all of the mower and engine factory warranties.

* **MULCHING KITS** – These generally consist of mulching blades and a mulching plug (which closes off the discharge opening to keep the clippings contained under the deck for re-cutting) plus any necessary hardware for installation. Please check with your parts distributor regarding the contents of a particular mulching kit.



SERVICE SECTION

SECTION 1: HYDROSTATIC SYSTEM

The hydro overflow tank on a ZT is located behind the seat. Notice the “full cold” line at the bottom of the tank. Use only 20w50 motor oil in this tank. Conventional or synthetic oil may be used.

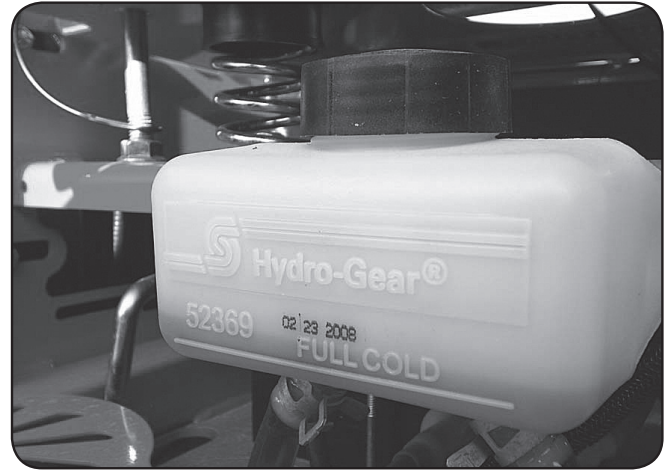

When servicing a mower with a sealed transaxle unit, start by removing the filter skid plate on the bottom of each unit. The skid is held on by three 10mm bolts. Next, remove the filter. The filter also serves as the oil drain. Each transaxle holds about 2 quarts of hydro oil. Re-install new filters and skid plates. Use only hydro-gear filters. Use of any other type of filter will result in damage to the hydro system and void the warranty. Transaxle service recommended within the first 50 hours of usage and every 250 hours thereafter or once a year.

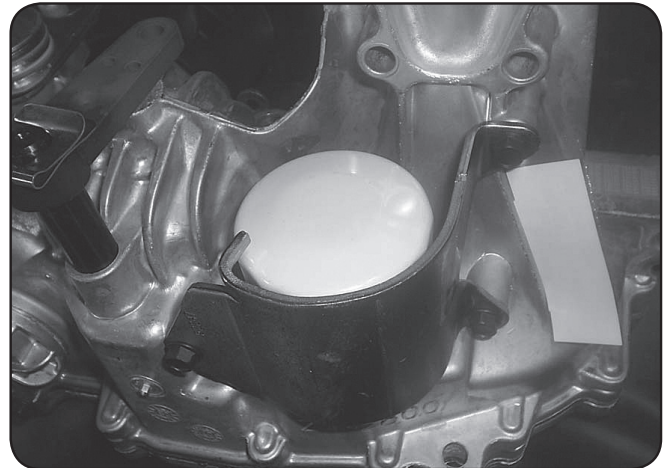

The check plug is located at the top center of the inside case of each transaxle. The transaxle can be filled with oil by removing these check plugs from both transaxles and pouring the oil in the hydro overflow tank, located behind the seat. Oil will begin to run out of the check plug holes when the transaxles are full. Use only 20w50 motor oil in the hydro system.

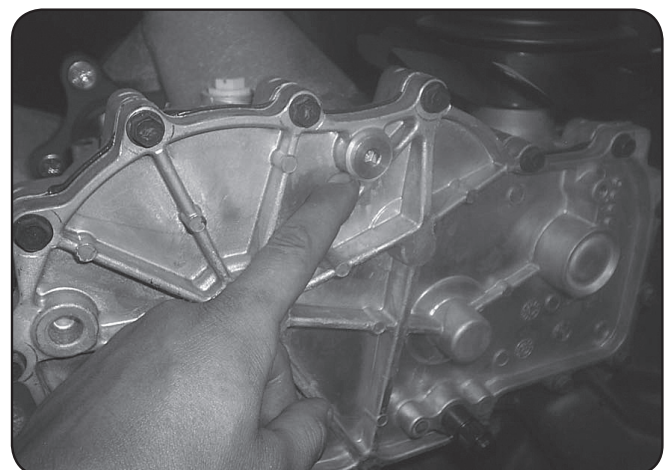

Once the system is filled with oil, lift rear of mower until rear tires are off the ground. Start engine, release parking brake, stay clear of moving rear tires. Next, pull the neutral bypass levers (located at the rear of the frame, on either side of the muffler), move the drive arms forward and backward 4 to 6 times slowly. This relieves any air that may be trapped in the system. It may be necessary to add more oil to the hydro overflow tank after 10-15 minutes of running. These bypass levers also serve as a neutral for moving the mower without the engine running.

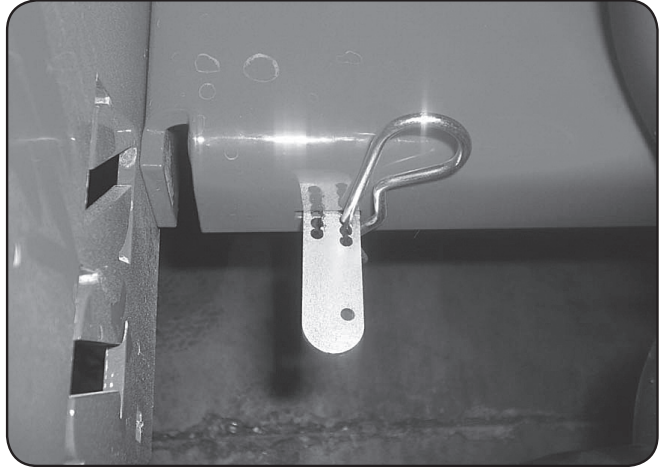

SECTION 2: DRIVE BELT

Shown on the right is a typical pump belt tensioner for your ZT model mower.

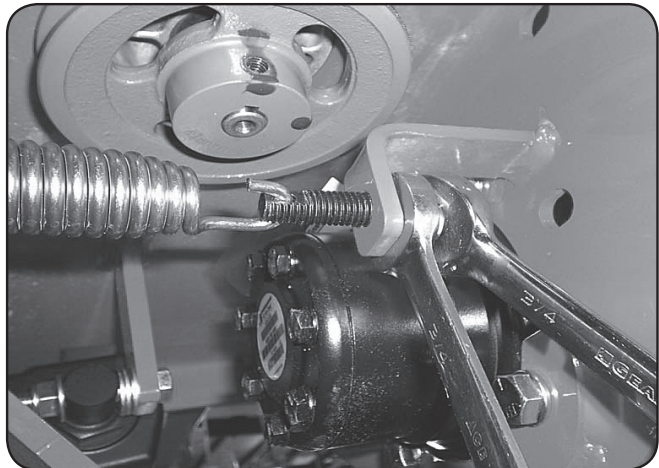

Tightening the two $\frac{3}{4}$ " jam nuts on the right side will increase the belt tension on all models. Factory setting is about .030" (about the thickness of a credit card) between coils as shown.

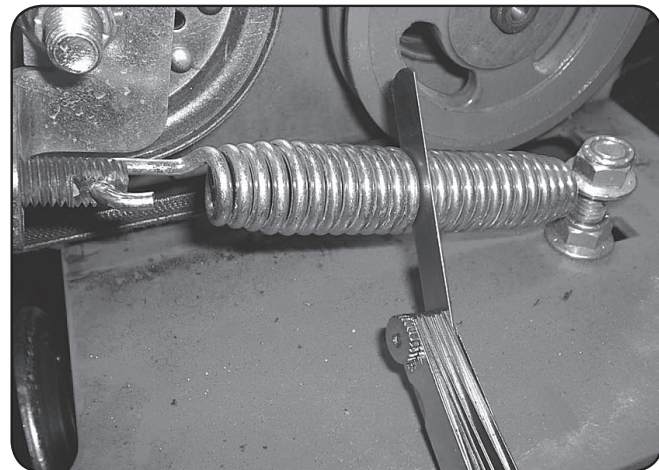

SECTION 3: ENGINE

Most models have a drain hose installed on the engine, for easier oil changes. All gas engines used by Bad Boy use 10w30 and have an oil capacity of 2 quarts. Bad Boy recommends that the oil and filter be changed every 50 hours of usage.

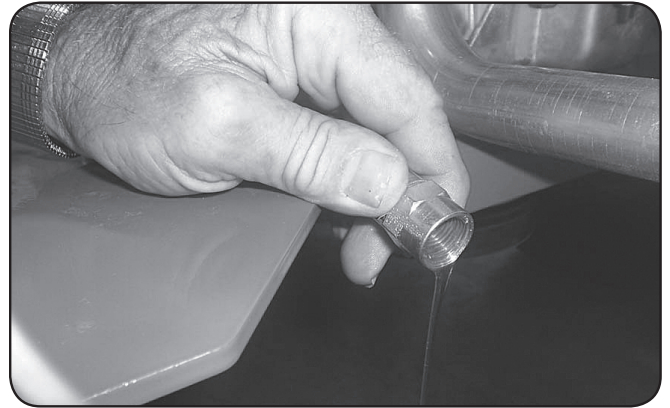

The fuel filter is located in the fuel line about 12" from the carburetor on the side of the engine. Note the direction of flow on the side of the filter. Replace once a year.

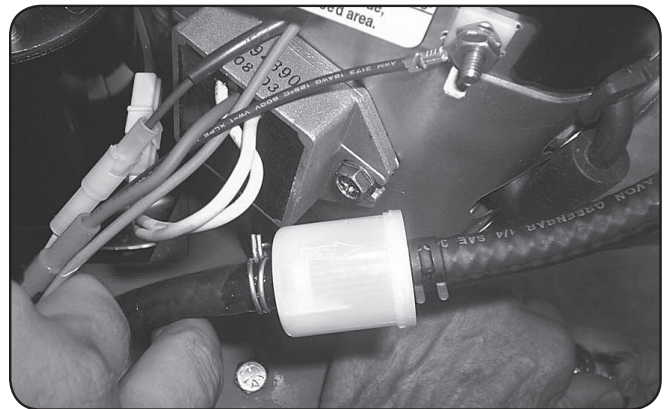

Remove and inspect air cleaner weekly. (More often in dusty conditions). Do not blow filter out with air pressure, this will cause the filter to be filled with tiny holes that will allow dirt to enter. Instead, tap filter on side to remove any debris. Replace at least once a year, more often in dusty conditions



Torque the clutch bolt to 50 ft. Lbs. on all models.
Re-torque at every oil change.
(All Models)

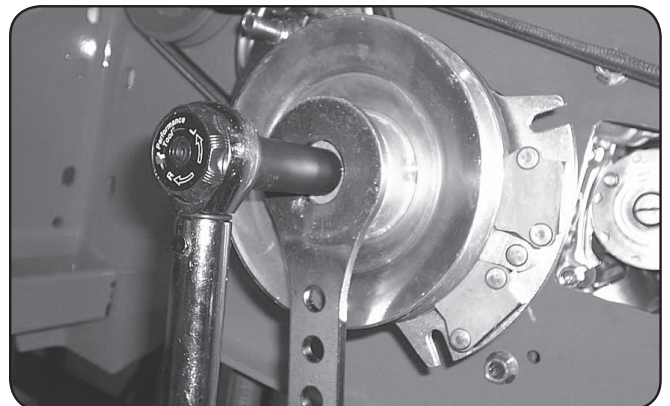

SECTION 4: ELECTRICAL SYSTEM

On most larger commercial engines (27 hp and up), the 25 amp main fuse is located about 3" from the starter on the engine. (shown in first image on right). On smaller commercial and light duty commercial mowers, the 25 amp main fuse is located just behind the battery connected to the starter solenoid. (Shown in second image on right).

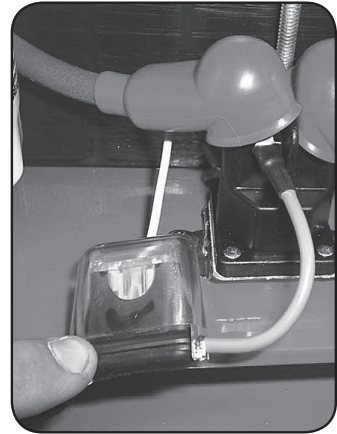
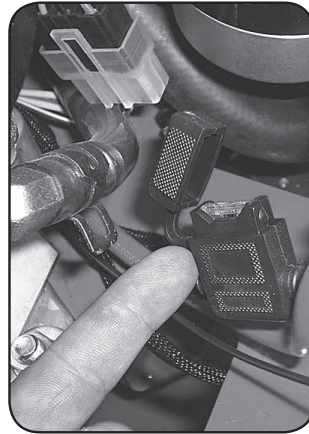

Always check the condition of the wiring harness ground cable. The ground is located just inside of the right side fuel tank on most models. Ensure that the ground is connected, clean, and tight. On some models, this wire may be connected to the negative side of the battery.

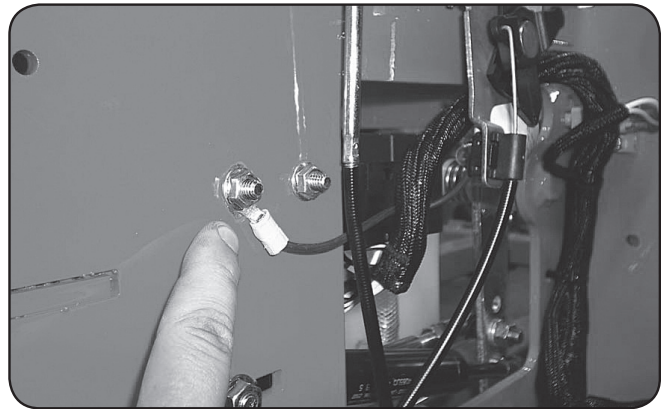

Check the condition and connection of the relays located under the seat. Ensure that they are clean and connected. Make sure that wire terminal ends have not been pushed out of the relay block.

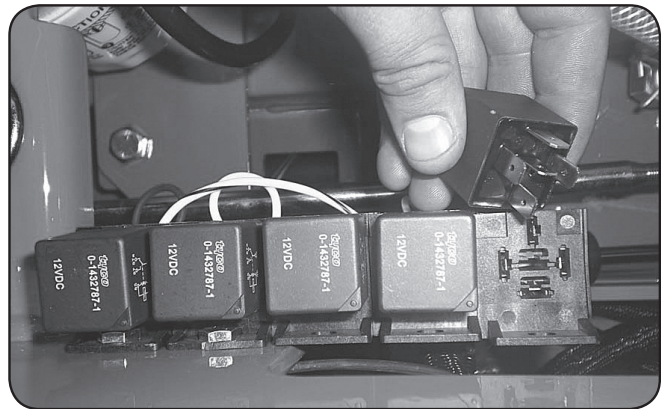

On most models, the red wire coming out of the engine is the charging wire from the alternator. Check for 13.6—14.2 volts DC at this wire with engine at full throttle.

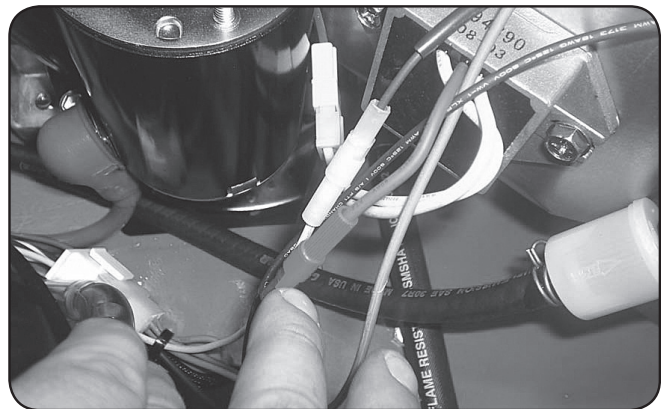

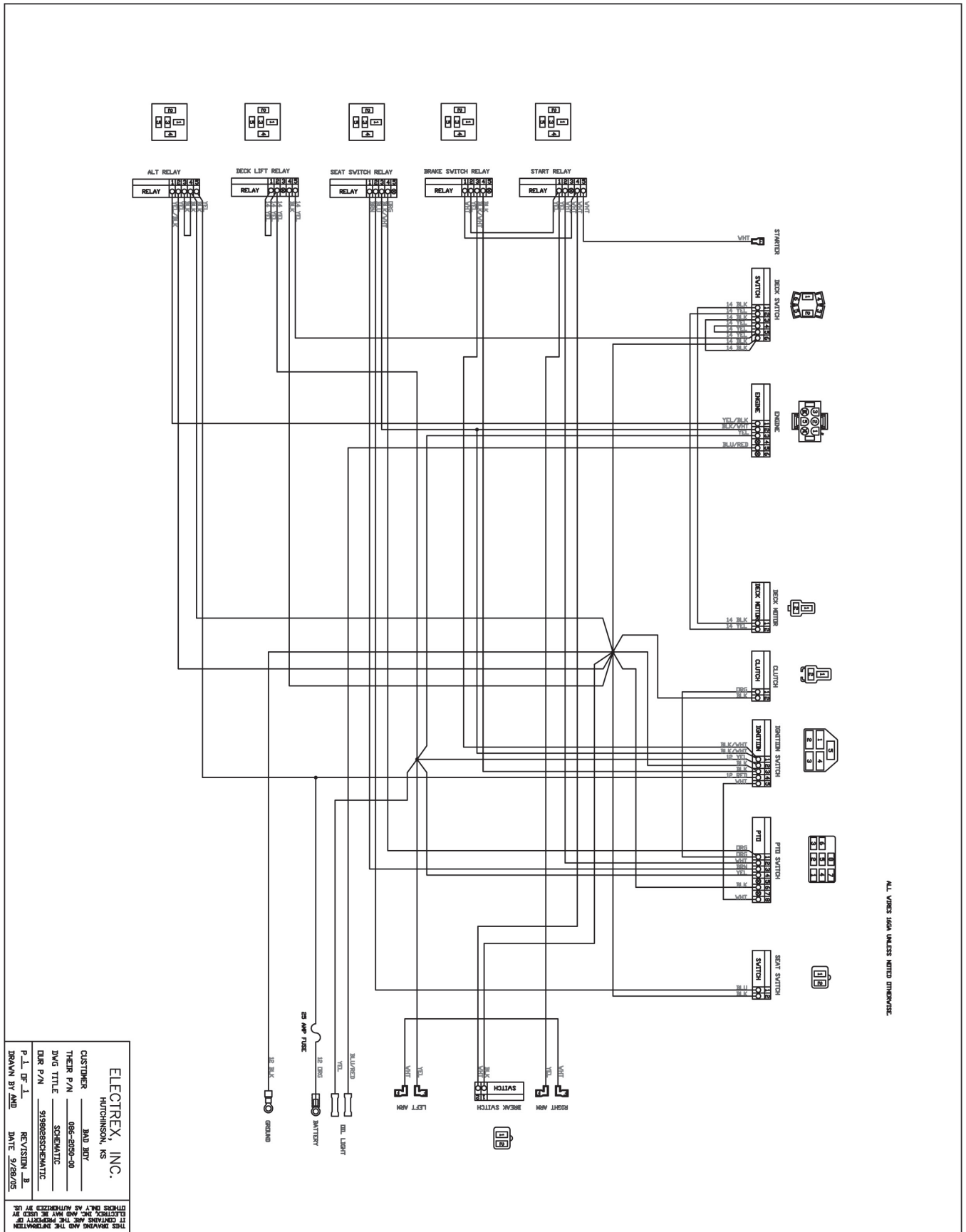

ALL VIEWS FROM UNLESS NOTED OTHERWISE.

ELECTREX, INC.
 HUTCHINSON, KS
 CUSTOMER: BAD BOY
 THEIR P/N: 086-6501-60
 DWG TITLE: SCHEMATIC
 OUR P/N: 919868SCHEMATIC
 P. 1 OF 1 REVISION: B
 DRAWN BY: AMJ DATE: 5/28/05

THIS DRAWING AND THE INFORMATION IT CONTAINS ARE THE PROPERTY OF ELECTREX, INC. AND MAY BE USED BY OTHERS ONLY AS AUTHORIZED BY US.

SECTION 5: FRAME

For non-suspension models, torque front fork castle nut to 40 ft.lbs. Be sure to spin the fork while torquing the nut to ensure that no bearing damage is done.

Be sure to reinstall the cotter pin into the castle nut. Always try to go tighter on the nut to find a castellation for the pin to fit in. Never back the bearing tension off after torquing the nut, this will “spring” the bearing cage.

Torque rear wheel lugs to 65-75 ft.lbs.
Re-torque at every oil change.

There is one grease fitting in each front wheel and one in each front caster bearing housing. Grease at every engine oil change.

There is one grease fitting on each of the actuator bar pillow blocks located under the fuel tanks. Grease twice a season.

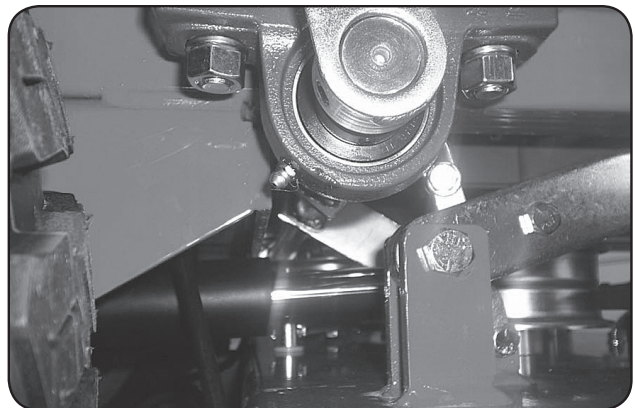
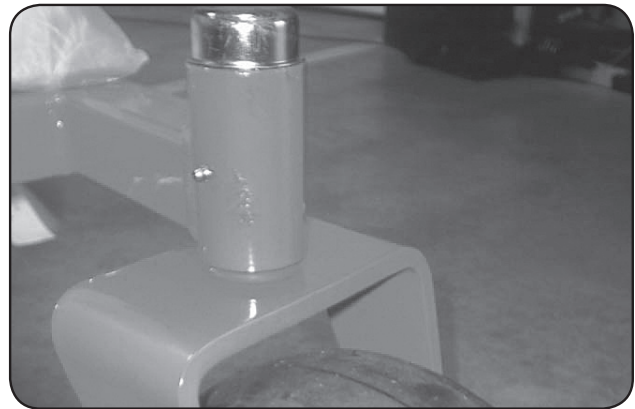
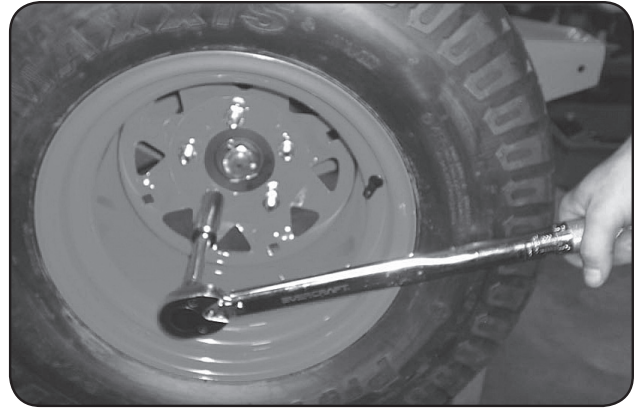



The pump belt tensioner is located under the engine and has a grease fitting at its pivot point. Grease at every engine oil change.

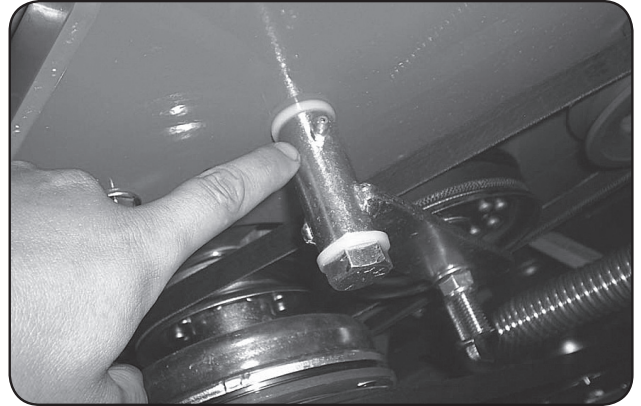

The deck belt tensioner is located at the rear of the deck and has a grease fitting on its pivot point. Grease at every engine oil change.

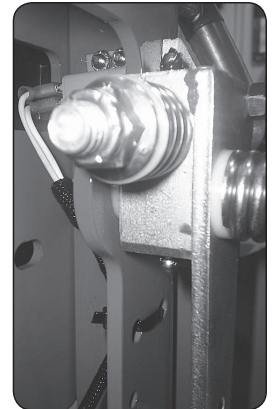
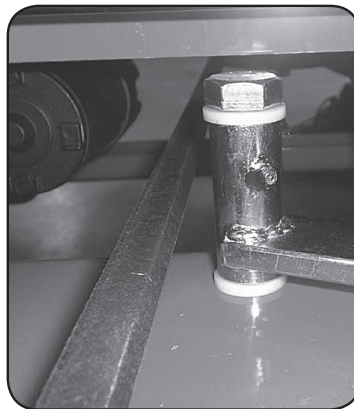

The control arm blocks have grease fittings located on the top and bottom of each block. Grease one time a year.

SECTION 6: CUTTING DECK

To remove the deck belt, lift up on the belt while rotating the pulley to roll the belt up and off of the pulley. (be sure not to get your fingers between belt and pulley).

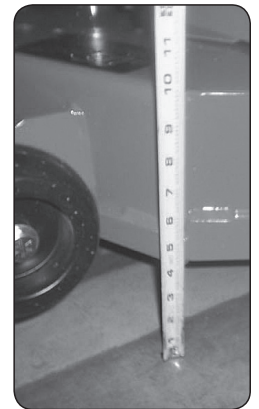

To check the level of the deck, start on a flat surface and set the air pressure in all four tires. Raise the deck up, and measure all four corners of the deck to see if it is level from left to right and front to back. All decks should be level from left to right and have a 1/8" pitch down in the front.

If deck adjustments are necessary, start with the chain length adjusters. These adjusters affect the overall height of the deck and the level from left to right.

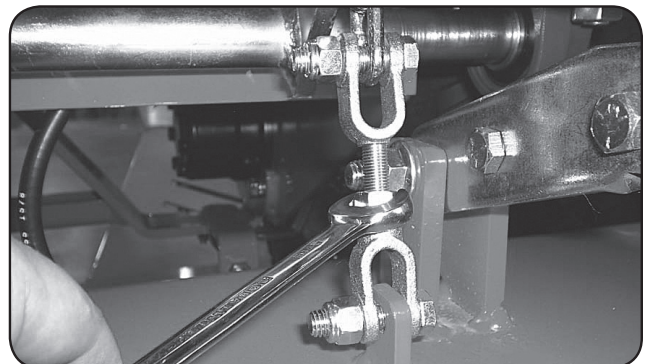

The large turn buckles on the front of the deck only affect the pitch of the deck or the level from front to back.

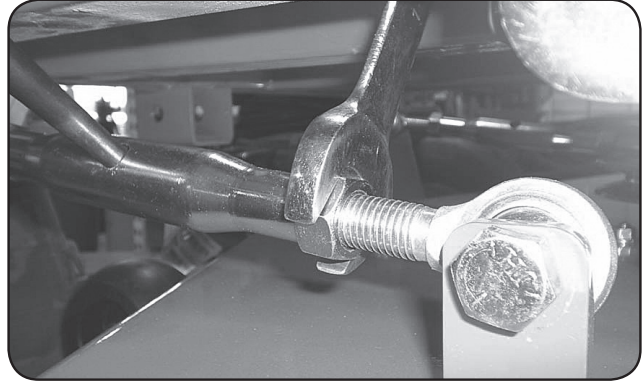

The deck spring tension is critical. If the tension is too much, it will cause the spring to break. If too loose, the belt can jump off or slip on the pulleys and cause a cut quality issue. With the deck up, the spring coil gap should be about .025" - .030" (about the thickness of a credit card). Spring tension adjustments can be made by sliding the bolt shown above forward or backward in the slot of the deck.

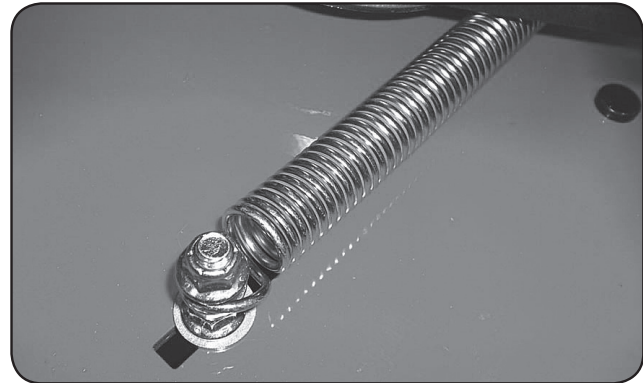

The condition of the blades can drastically affect the cut quality of the mower deck. Replace as necessary. These blades were used considerably too long. Resharpenering is recommended by professionals only to determine when the blade needs to be replaced and because of the need for rebalancing.

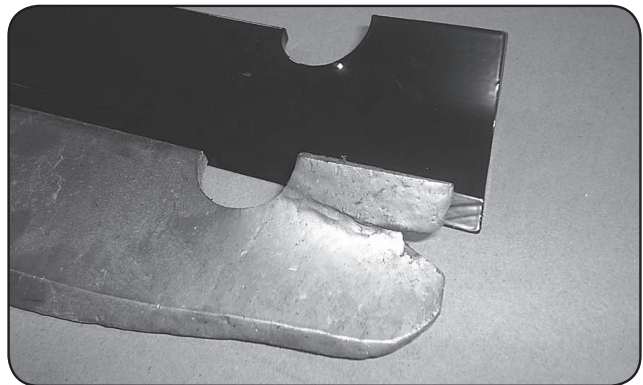

To change blades, it may be easier to use a piece of wood to keep the blade from turning so that the bolt can be loosened. Re-torque the blade bolts to 90-110 .lbs.

The blade spindles contain a sealed ball bearing in the top and bottom of the spindle. The bearings are replaceable for a more cost effective repair.

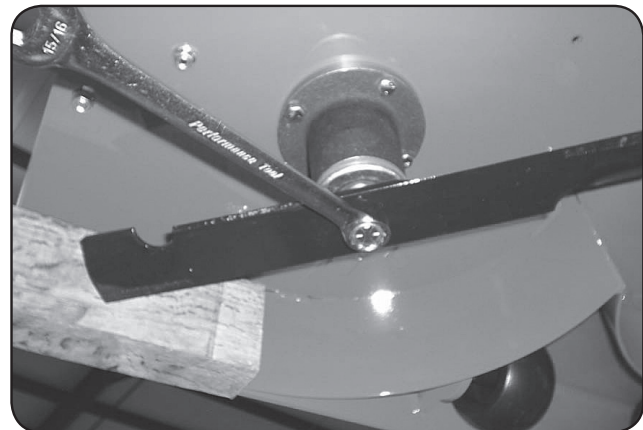
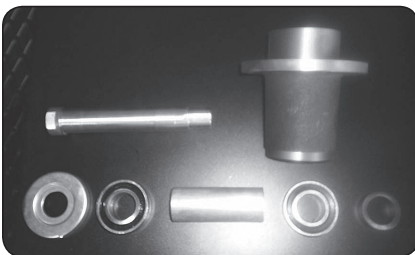



MOWING TIPS:

- Mow header strips at the ends of the lawn and around flower beds first. Make them wide enough that you can turn the mower around in the already mown section. Then mow back and forth between these header strips overlapping each lap by about 1/8 the width of the mower's deck.
- Don't cut your grass too short, particular for cool season grasses. Higher heights usually provide for a deeper root system, looks better, and is less likely to have weeds invading, particularly crabgrass.
- Don't remove any more than one third of the grass leaf at any one cutting. If circumstances arise that a lawn gets too tall and you just have to lop off a bunch to get caught up, bite the bullet and break it down into several mowings to get caught up with 3 or so days between cuttings.
- **NEVER SCALP YOUR LAWN.** Scalping severely damages the root system to such a degree that it may die.
- Avoid mowing when the grass is wet or when it's dark
- Avoid throwing grass clippings into the street and driveway where they can be washed into the sewer system. After mowing, clean up driveway and walkways.
- When mowing remove only a third with each cutting (except for the first mowing of the season when it's ok to remove more). You can safely leave clippings that will quickly decompose and add nutrients back into the soil. Contrary to popular opinion, grass clippings do not add to thatch buildup. Grass blades are made up of about 75% water.
- Mow your lawn in a different direction with each mowing, especially with lawns of shorter grass types. Altering the direction ensures a more even cut since grass blades will grow more erect and less likely to develop into a set pattern.
- Keep your mower's blade sharp, which means having it sharpened several times during the mowing season. Keep several blades around so you'll always have a sharp one on hand. Sharp blades cut the grass cleanly and help mulch clippings into small pieces which break down quickly.
- Don't forget to change your mower's oil at least once during the mowing season. For brand new mowers, change the oil after about 5 hours of operation during the initial break-in period.
- At the end of the mowing season use a fuel stabilizer in the remaining gasoline
- In the spring, don't use that old gas unless you properly used a fuel stabilizer, it can cause a number of problems. Better to use fresh gasoline to begin the new mowing season.
- **Leaf blade A** demonstrates what a leaf blade should look like after mowing with a sharp blade.
- **Leaf blade B** demonstrates a leaf blade that was injured by a dull mower blade.
- **Leaf blade C** was cut by the mower but indicates that the mower blade is not sharp enough. The shredded white tissue protruding from the leaf blades C and D is the vascular tissue of the plant.
- **Leaf blade D** has been mown for quite some time with a dull mower blade.

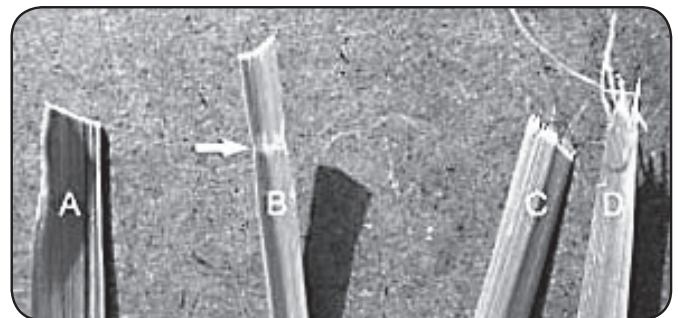

To bag or mulch?

Grass clippings do not contribute to thatch buildup or increase the chances of disease. If you mow your lawn at the right height, without removing any more than 1/3 of it's total height, clippings will quickly breakdown without a trace. These clippings contribute additional nitrogen and other nutrients to the soil and supply it with additional organic materials. Clippings from a 1000 sq. ft. lawn can add as much as 1 - 2 pounds of nitrogen back into the soil.

If you have a compost pile, then you may want to bag your clippings occasionally to add much needed green-matter to the compost pile. Make sure it is mixed thoroughly with brown matter to avoid a strong ammonia odor. **DO NOT COMPOST CLIPPINGS** after applying any weed control or weed-feed type product. Before adding clippings to the compost pile wait at least 3 mowings after these products have been applied.

PARTS SECTION

Front Fork Assembly

Front Fork Assembly			
ITEM	QTY	PART NUMBER	DESCRIPTION
1	1	023-7913-00	Front Fork
2	1	013-7004-00	1" Fine Threaded Castle Nut
3	1	012-7003-00	Seal
4	1	013-8050-00	1/2-13 Nylon Flange Nut-Orange
5	1	018-7010-00	1/2" x 9" Bolt
6	1	014-7005-00	Dust Cover
7	1	020-7022-00	1/8x2-1/4 cotter pin Zinc
8	2	010-7001-00	Bearing
9	1	022-2006-00	Tire and wheel assembly
10	1	025-5202-00	Front Wheel Spacer
11	2	022-7009-00	Wheel Bearing

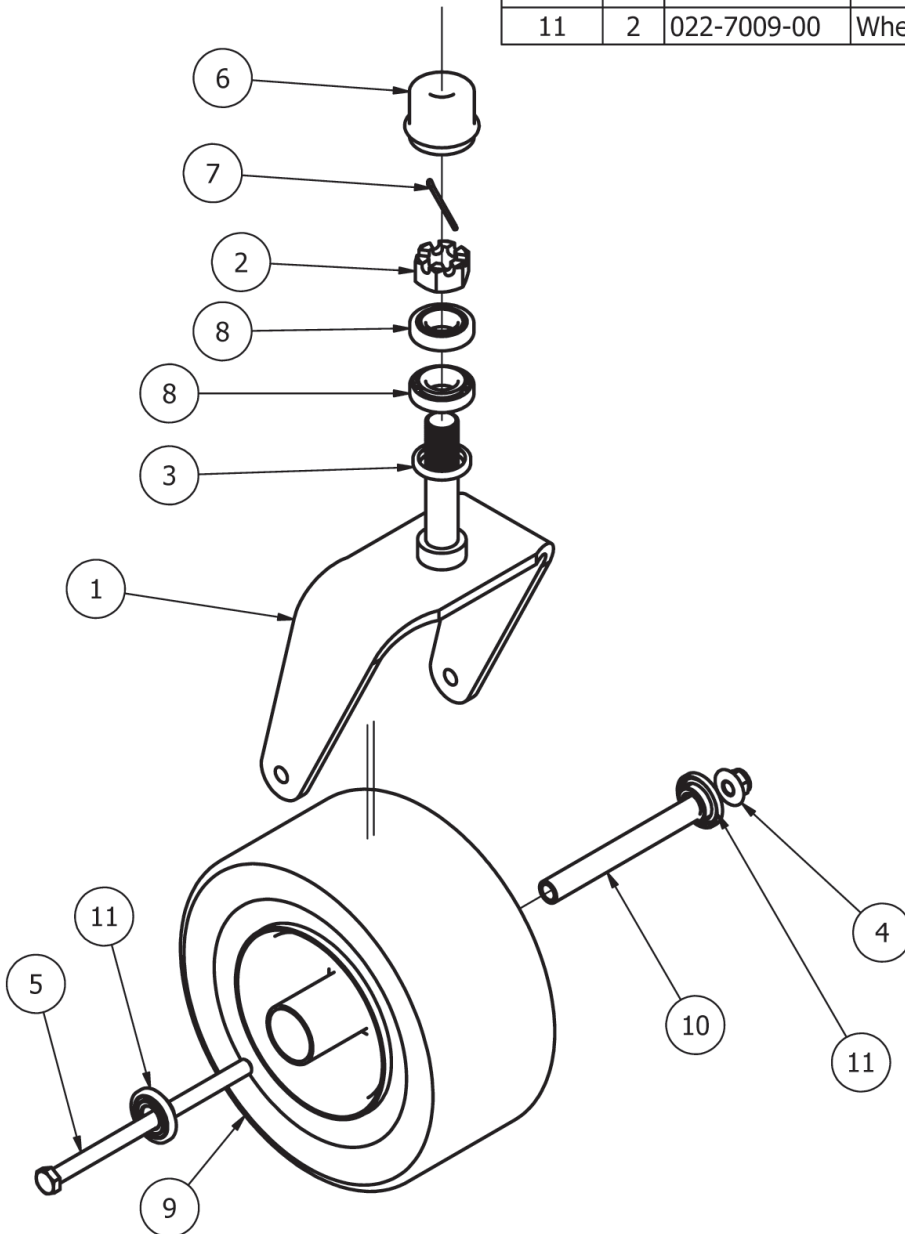



ZT Transaxle Assembly

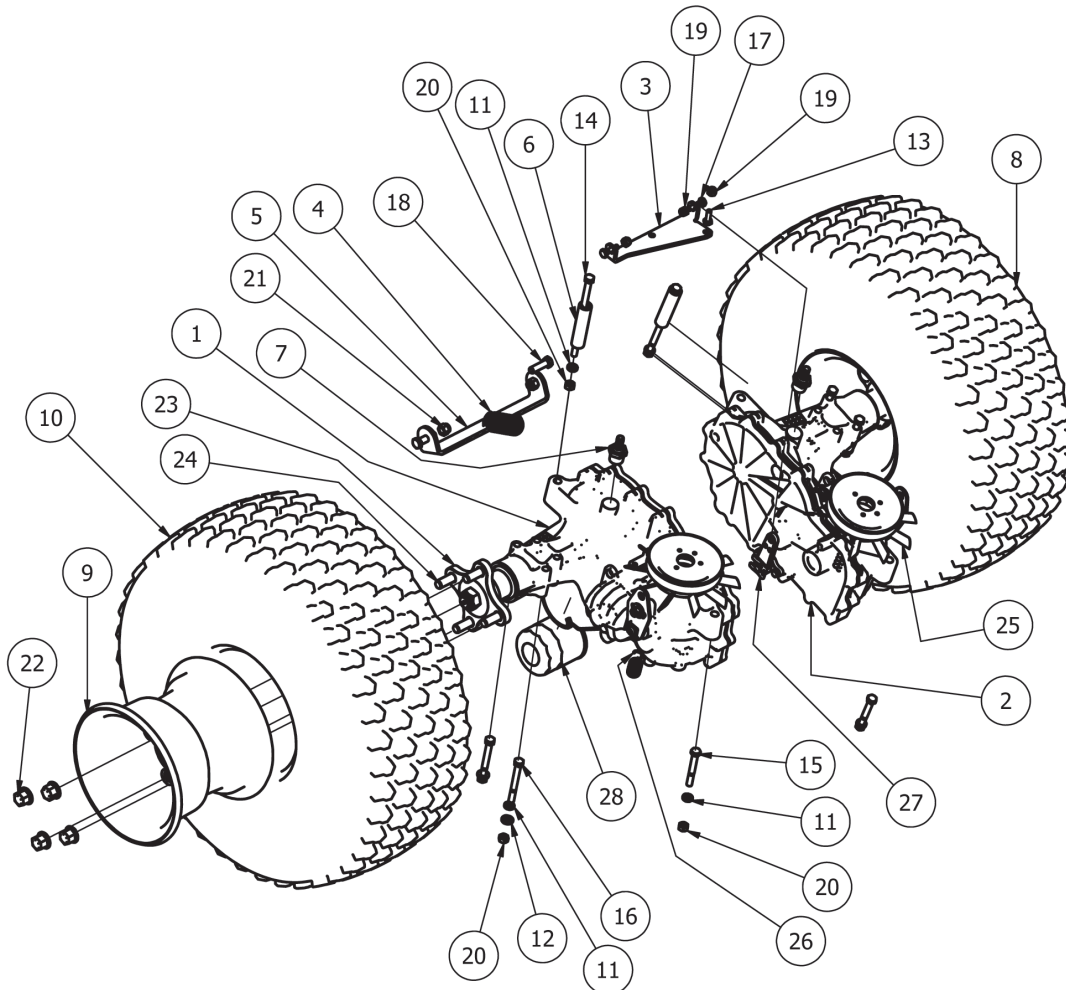

ZT Axel Assembly			
ITEM	QTY	PART NUMBER	DESCRIPTION
1	1	050-2080-00	Right ZT Transaxle
2	1	050-2081-00	Left ZT Transaxle
3	1	039-0053-00	ZT Crossover Brake Bracket
4	1	034-9000-00	ZT spring
5	1	028-4801-00	Crossover Bar for ZT
6	2	025-5340-00	Transaxle Spacer
7	2	024-1200-00	45 degree fitting
8	2	022-6000-00	20 x 10-8 Tire and wheel Assembly
9	1	022-6002-00	8 Inch Wheel
10	1	022-6001-00	20X10-8 Turf Tire
11	8	019-8051-00	5/16" Lock Washer
12	4	019-8044-00	5/16" Flat Washer
13	1	018-8052-00	1/4" x 3/4" Hex Bolt
14	2	018-5355-00	5/16" x 6" Bolt
15	2	018-5344-00	5/16" x 2 1/2" Bolt
16	4	018-4701-00	5/16" x 3" Hex Bolt
17	2	018-4007-00	Hex Bolt - UNC (Regular Thread - Inch)
18	2	018-3000-00	3/8" x2" Hex Bolt
19	3	013-8073-00	1/4" Nylock Nut
20	8	013-8043-00	5/16" Nut
21	2	013-5041-00	3/8 Nylock Nut
22	8	013-3000-00	Acorn Lug Nut
23	1	050-2076-00	ZT Transaxle Hub
24	1	050-2012-00	Transaxle Wheel Studs
25	1	050-2075-00	Fan/Pulley Kit
26	1	034-9080-00	Transaxle Spring
27	1	092-8000-00	Transaxle Brake lever
28	2	063-1050-00	ZT Hydraulic Filter

Air line complete assembly
051-8072-98

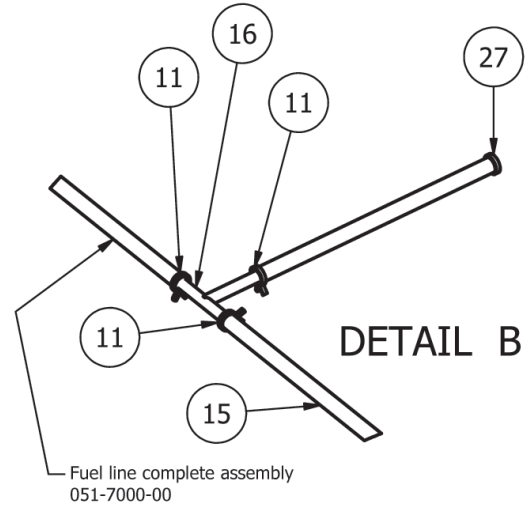
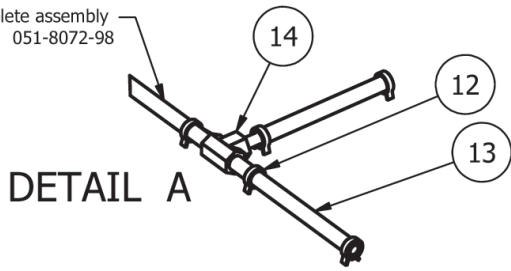

Fuel Tanks

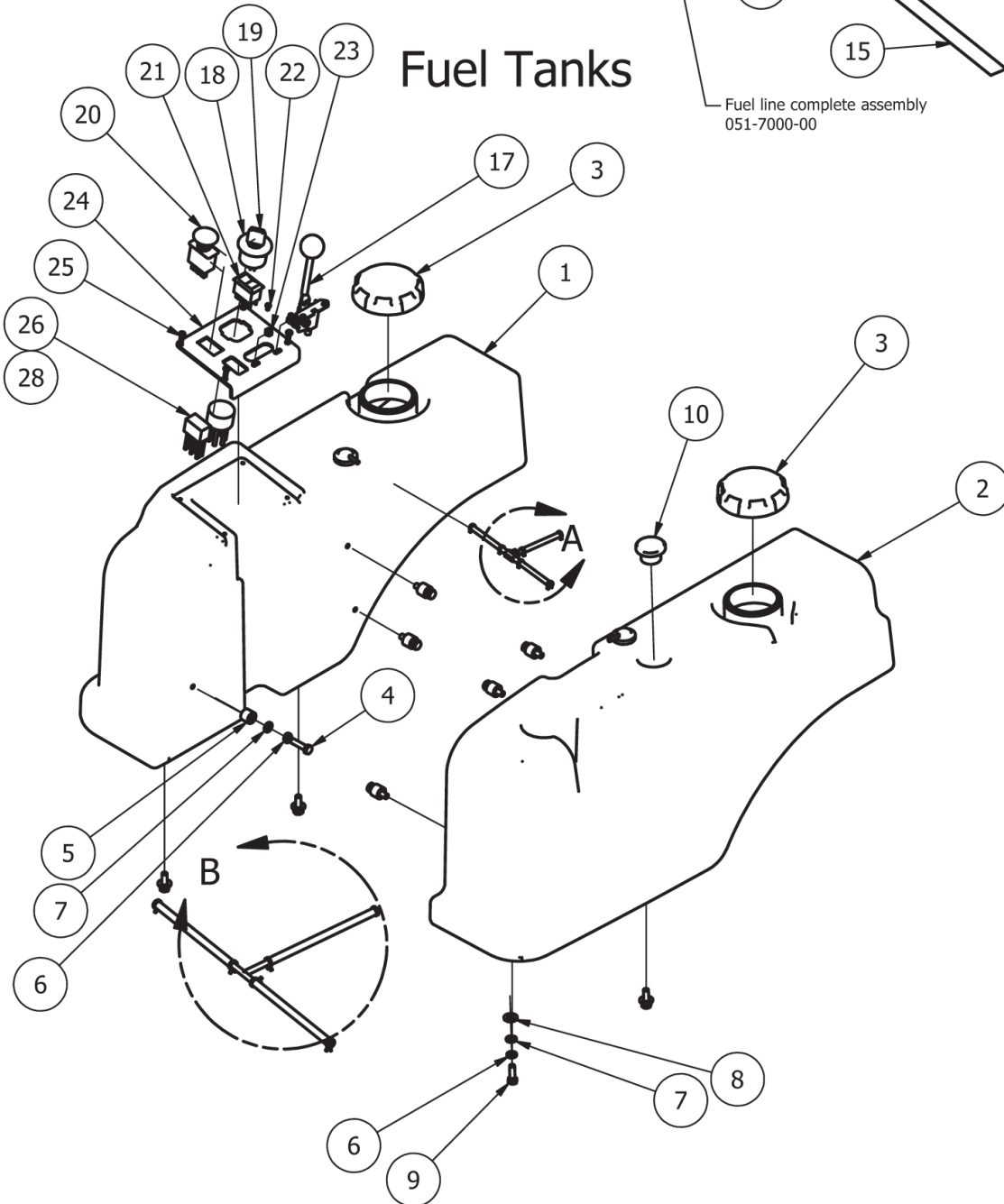



Gas Tanks and Control Panel Assembly			
ITEM	QTY	PART NUMBER	DESCRIPTION
1	1	067-7000-11	ZT Fuel Tank- Right
2	1	067-7001-11	ZT Fuel Tank- Left
3	2	066-8083-00	Fuel Cap
4	6	018-2006-00	5/16 x 1 1/4 Hex Bolt
5	6	025-2000-00	.380x.735x.470 Nylon Spacer
6	10	019-8051-00	5/16" Lock Washer
7	10	019-7040-00	1/4" Flat Washer
8	4	019-6042-00	.360 ID Plastic Washer
9	4	018-2007-00	5/16" x 1" Bolt
10	1	067-4025-00	Fuel Gauge and Grommet
11	6	072-8069-00	1/4 fuel clamp
12	6	072-8072-00	1/4" vinyl hose clamp
13	3	051-8073-00	3/16 vinyl tubing
14	1	073-2000-00	Brass fuel line T
15	3	051-8067-00	1/4" fuel line hose
16	1	073-8068-00	fuel line T
17	1	055-8020-00	Throttle
18	1	077-8076-00	Ignition Switch
19	1	042-9000-00	Ignition Key
20	1	056-8058-00	PTO Engager
21	1	078-3000-00	Rocker Deck Lift Switch - 2011 & up
22	2	018-5200-00	10-24 X 5/8 BS C/S 18-8 SS
23	2	013-5019-00	10-24 Nylon Insert Locknut
24	1	079-3400-00	Control Panel ZT
25	4	018-2010-00	10-32 x 3/8" Button Socket Head Bolt
26	1	086-3050-00	Wiring Harness ZT only-2008 and up
27	1	072-8073-00	3/16" Vinyl Hose Clamp
28	1	086-1201-00	Relay Terminal

ZT Drive Arm Assembly

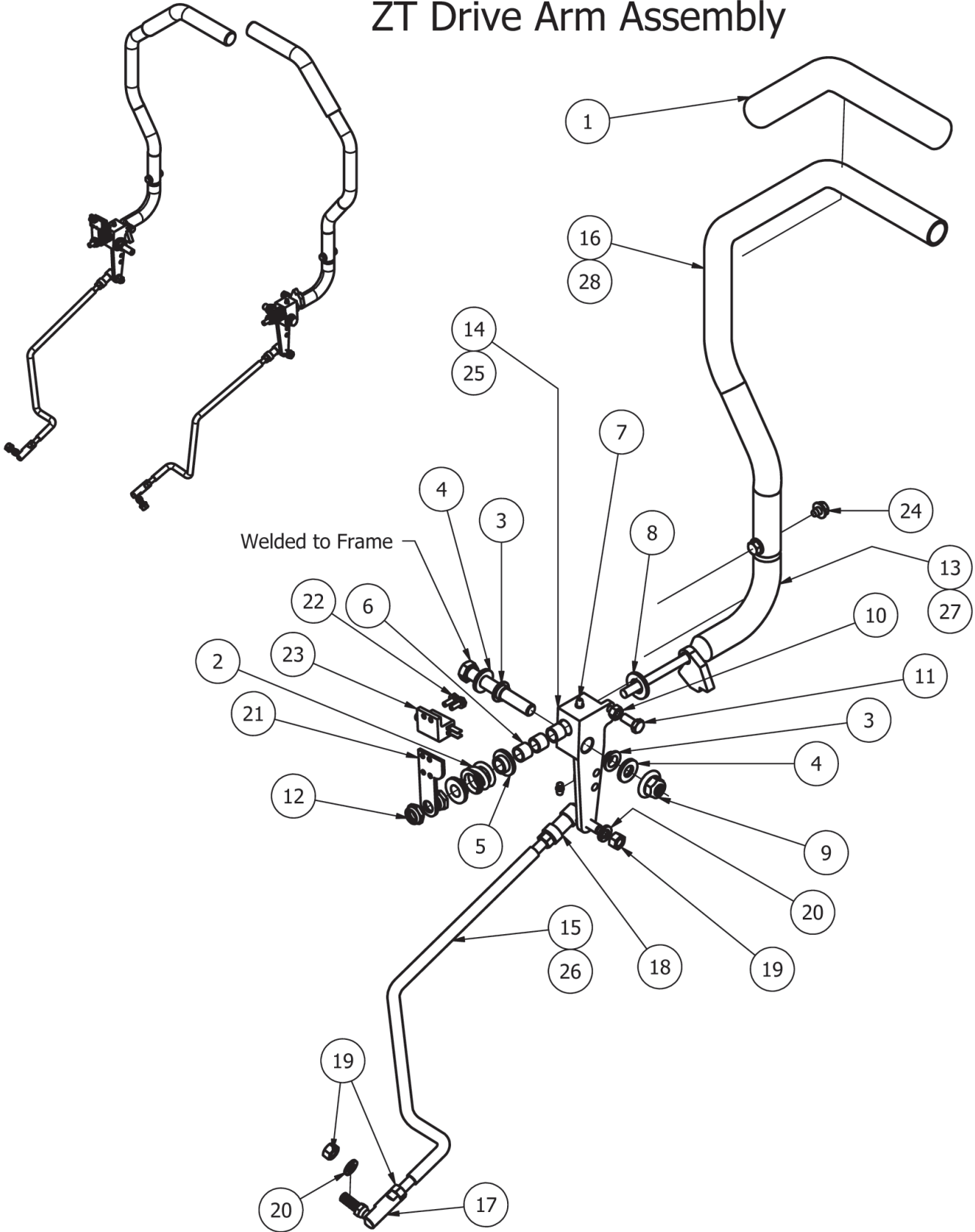



ZT Drive Arm Assembly			
ITEM	QTY	PART NUMBER	DESCRIPTION
1	1	069-4007-00	Rubber Grip
2	1	034-8025-00	Drive Lever Spring
3	2	032-5055-00	Bushing for 2012 Drive Arms
4	2	019-7000-00	.505x1x .125 Oil Impregnated washer
5	2	019-8027-00	.515 ID Nylon Shoulder Washer
6	3	032-8024-00	.507 ID Nylon Bushing
7	2	024-6034-00	1/4" Drive in Grease Fitting
8	1	019-6017-00	.635 ID Plastic Washer
9	1	013-8050-00	1/2-13 Nylon Flange Nut-Orange
10	1	013-8043-00	5/16" Nut
11	1	018-8063-00	5/16" x 3/4" Hex Bolt
12	2	018-4010-00	1/2" Nylcock Nut (1/2 Jam)
13	1	031-9020-00	Steering Arm Elbow Left
14	1	027-9000-00	Drive Arm Lever Housing (Left)
15	1	035-5400-00	Transaxle Drive Rod (Right)
16	1	031-8850-00	ZT Direction Steering Arm (Left)
17	1	099-6046-00	3/8-24 Ball Joint
18	1	099-2009-00	3/8-24 Quick Release Ball Joint
19	4	013-6051-00	3/8" Fine Threaded Jam Nut
20	2	019-5037-00	3/8" Lock Washer
21	1	039-0021-00	Switch Bracket- ZT
22	2	018-1080-00	12-24x 1/2 HWH Bolt
23	1	077-8073-00	Safety Switch
24	2	018-2020-00	5/16-18 1/2 HWH Bolt-Steering
25	1	027-9001-00	ZT Drive Arm Lever Housing (Right)
26	1	035-5401-00	Transaxle Drive Rod (Left)
27	1	031-9025-00	Stering Arm Elbow (Right)
28	1	031-8851-00	ZT Direction Steering arm (Right)

Actuator Bar Assembly

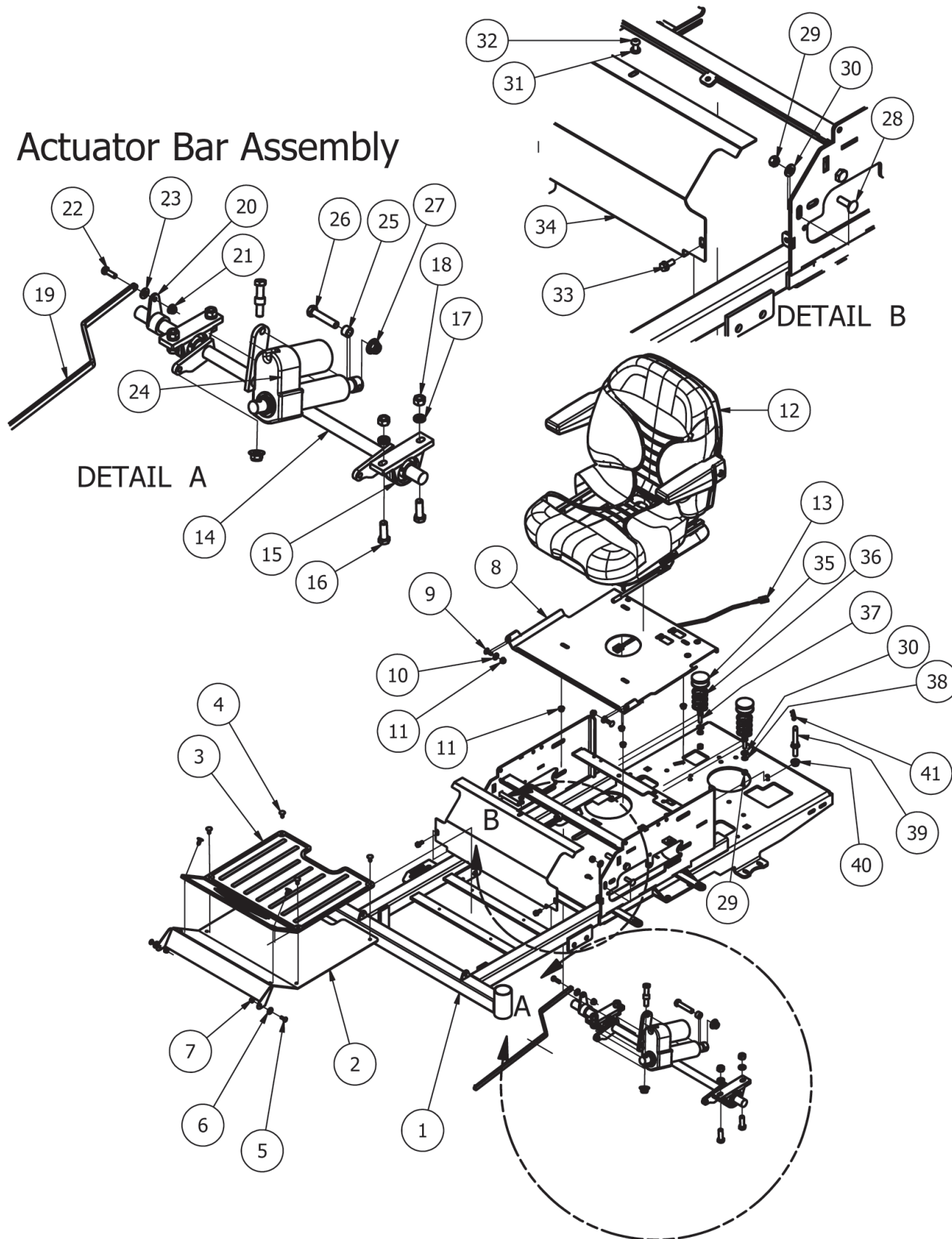



ZT Seat, Floor Panel, Actuator, and Cooler Cover Assemblies			
ITEM	QTY	PART NUMBER	DESCRIPTION
1	1	070-5400-00	ZT Frame
2	1	079-3410-00	ZT Floor Panel
3	1	081-2010-00	Zt Floorboard Mat
4	6	040-6080-00	Ratchet Fastener
5	2	019-8040-00	1/4" x 3/4" Carriage Bolt
6	2	019-6042-00	.360 ID Plastic Washer
7	2	013-8073-00	1/4" Nylock Nut
8	1	026-1010-00	ZT Seat Plate
9	2	018-8066-00	5/16" x 7/8" Carriage Bolt
10	2	019-6042-00	.360 ID Plastic Washer
11	6	013-9002-00	5/16" Flange Nut Zinc W/Serrations
12	1	071-2010-00	ZT/Pup Seat - WM1976
13	1	036-5300-00	Seat Switch Adapter
14	1	028-4020-00	Actuator Bar
15	2	017-7008-00	Pillow Block Bearing
16	4	018-5600-00	1/2" x 1 1/2" Hex Bolt
17	4	019-5007-00	1/2" Lock Washer
18	4	013-7018-00	1/2" Hex Nut
19	1	028-2502-00	Height Indicator Bar
20	1	031-7000-00	Height Indicator Lever
21	1	013-9002-00	5/16" Flange Nut Zinc W/Serrations
22	1	018-2007-00	5/16" x 1" Bolt
23	1	019-6042-00	.360 ID Plastic Washer
24	1	035-7033-00	Actuator
25	2	025-7036-00	1/2 x 1/2 Spacer
26	2	018-6036-00	1/2" x 2 1/2" Hex Bolt
27	2	013-8050-00	1/2-13 Nylon Flange Nut-Orange
28	2	018-5043-00	3/8" x 1 1/4" Carriage Bolt
29	4	013-6014-00	3/8" Hex Nut
30	4	019-5029-00	3/8" Flat Washer
31	1	019-8051-00	5/16" Lock Washer
32	1	018-5007-00	5/16" x 3/4" Button Head Bolt
33	2	030-7042-00	5/16 x 3/4 washer head type F screw
34	1	014-3410-00	ZT Cooler Cover 2010 & Up
35	2	014-8047-00	Spring Cap Cover
36	2	034-8045-00	Seat Spring
37	2	018-5040-00	3/8" x 1 1/4" Hex Bolt
38	2	019-5037-00	3/8" Lock Washer
39	1	044-4000-00	Seat Braket Pin
40	2	013-5300-00	1/2" Flange Nut
41	1	040-6060-00	Seat latch pin

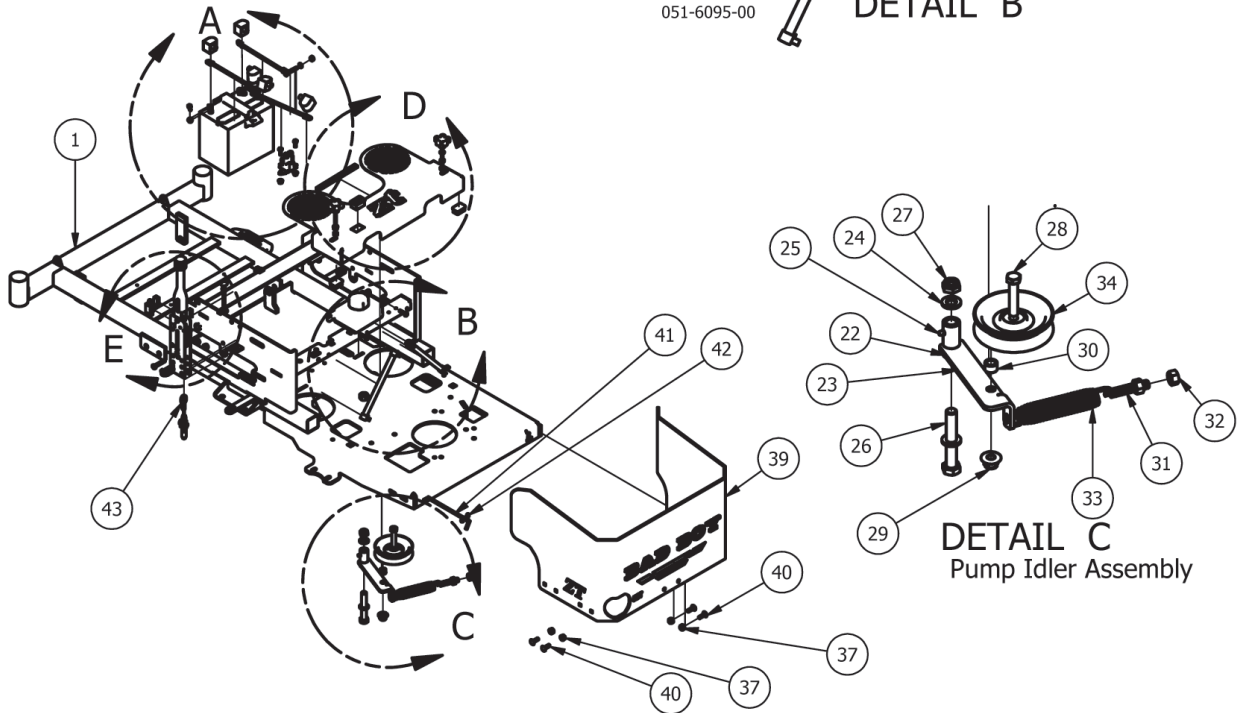
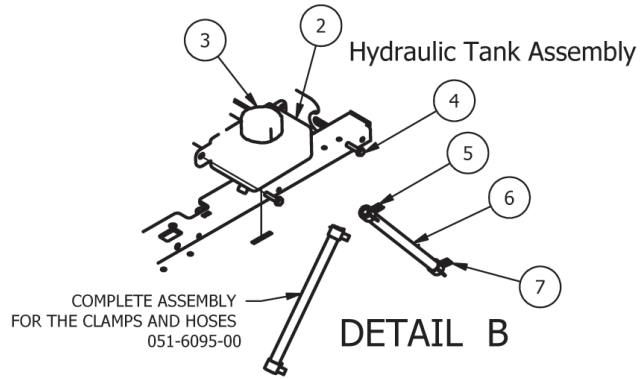
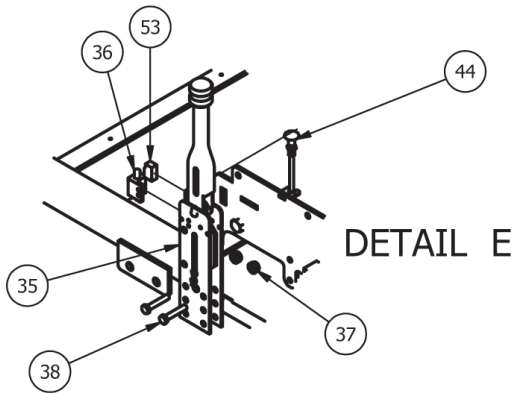
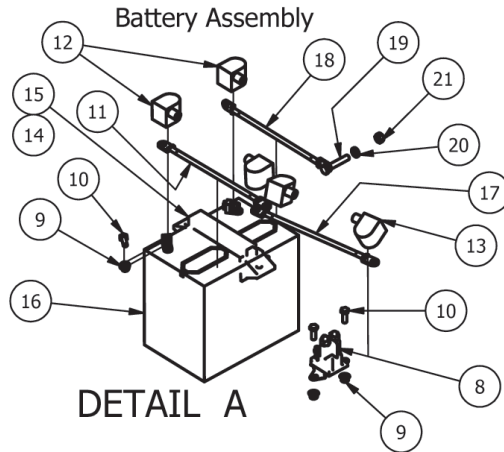
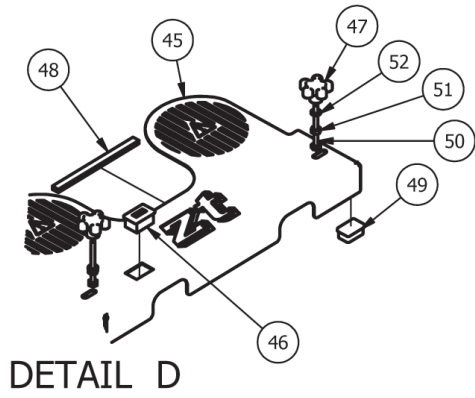



ZT Battery, Hydraulic Tank, Fan Cove, and Pump Idler Assemblies			
ITEM	QTY	PART NUMBER	DESCRIPTION
1	1	070-5400-00	ZT Frame
2	1	067-8080-00	ZT Hydraulic Tank
3	1	066-5050-00	Hydraulic Tank Cap
4	2	030-7040-00	1/4 x 1 Hex Head tek screw
5	2	072-8065-00	3/8 hose clamp
6	2	051-8063-00	3/8 clear hose price per foot
7	2	072-8066-00	1/2 Hose Clamp
8	1	108-5349-00	Solenoid
9	4	013-9001-00	1/4-20 Hex Flange Nuts Zinc w/Serrations
10	4	018-8052-00	1/4-20 x 3/4 GR 5 Hex Bolts Zinc
11	1	064-5301-00	12 in red battery cable
12	2	103-5400-00	Black Boot For ground cable
13	3	103-5300-00	Red Boot
14	1	043-8929-98	Hold Down Assembly
15	1	043-8929-00	Battery Hold Down
16	1	068-8049-00	ZT Battery
17	1	064-5300-00	24 in red battery cable
18	1	064-8061-00	Ground Cable
19	1	018-8059-00	5/16" x 1 3/4" Hex Bolt
20	1	019-8051-00	5/16" Lock Washer
21	1	013-8043-00	5/16" Nut
22	1	039-5944-98	Pump Idler Assembly Components 23,25,28,29,30,34
23	1	039-5944-00	Pump Idler Bracket
24	2	019-6017-00	.635 ID Plastic Washer
25	1	024-6034-00	1/4" Drive in Grease Fitting
26	1	018-5311-00	5/8" x 4" Hex Bolt
27	1	013-5301-00	5/8" Nylock (1/2 Jam)
28	1	018-6036-00	1/2-13 x 2 3/4 GR 5 Bolt
29	1	013-8050-00	1/2-13 Nylon Flange Nut-Orange
30	1	025-7036-00	1/2 x 1/2 Spacer
31	1	018-2004-00	All Thread-pump Idler Tensioner
32	2	013-7018-00	1/2" Hex Nut
33	1	034-2009-00	Deck Idler Spring
34	1	033-6001-00	4 3/4" Idler Pulley
35	1	069-8054-00	Brake Handle Kit
36	1	077-8073-00	Safety Switch
37	6	013-8049-00	5/16-18 Nylon Flange Nut
38	2	018-8059-00	5/16" x 1 3/4" Hex Bolt
39	1	026-0053-00	ZT Rear plate 26hp
40	4	018-8065-00	5/16" x 1" Carriage Bolt
41	2	031-0060-00	ZT Neutral level rod 2011
42	4	044-2004-00	Bow Pin
43	1	064-8055-00	Brake Cable
44	1	054-8017-00	Choke
45	1	026-0052-00	ZT Fan Cover
46	1	083-4013-00	Tachometer
47	2	045-6043-00	5/16" Knob
48	1	084-4015-00	Rubber Trim
49	2	014-3000-00	Square 3/4 Plug- SQR07-1620
50	2	018-4705-00	18x3 GR5 Hex bolt zink
51	2	013-8043-00	5/16" Nut
52	2	019-8051-00	5/16" Lock Washer
53	1	069-8055-00	Brake Plunger Stop

Kohler 27HP Courage

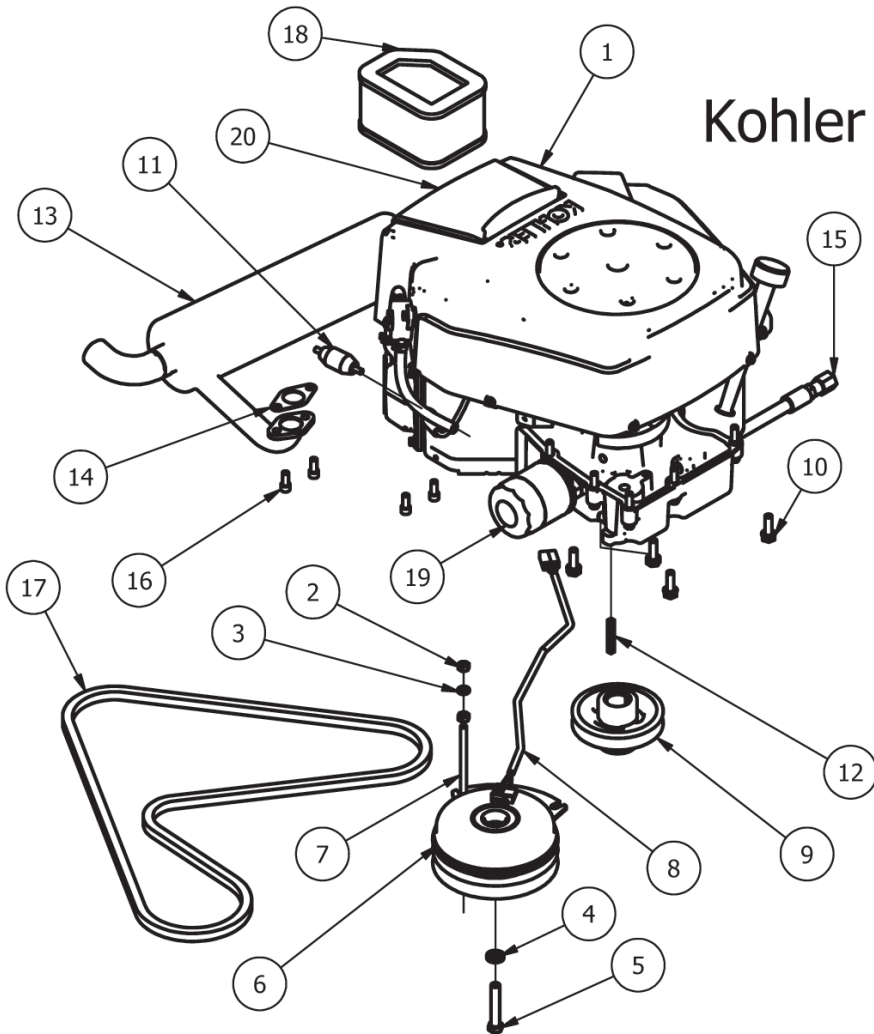

Kohler 27HP			
ITEM	QTY	PART NUMBER	DESCRIPTION
1	1	015-2700-00	Kohler27 HP Courage
2	2	013-8043-00	5/16" Nut
3	1	019-8051-00	5/16" Lock Washer
4	1	019-8053-00	7/16" Lock Washer
5	1	018-5300-00	7/16" x 2 1/2" Hex Bolt
6	1	070-1000-00	Clutch Assembly
7	1	018-5350-00	5/16-18 x 5-1/2 GR 5 Hex Bolt
8	1	070-2000-00	Clutch Pigtail
9	1	033-5035-00	4 3/4 Motor Pulley-ZT
10	4	018-1075-00	3/8 x 1 1/8 bolt
11	1	063-6000-00	Universal inline Fuel Filter
12	1	042-5020-00	1/4 x 2 Square key Stock
13	1	015-2750-00	27HP Kohler Exhaust
14	2	015-2751-00	Exhaust Gasket for 27, 30 HP
15	1	015-5401-00	Oil drain Valve
16	4	018-8067-00	5/16-18 x 3/4 Socket C/S
17	1	041-6400-00	Pump Belt
18	1	063-8080-00	Air Filter/Precleaner - Kohler
19	1	063-5400-00	Oil Filter -27& 30 Kohler
20	1	015-2701-00	27 KO Courage Air Cleaner Cover



27 HP Briggs

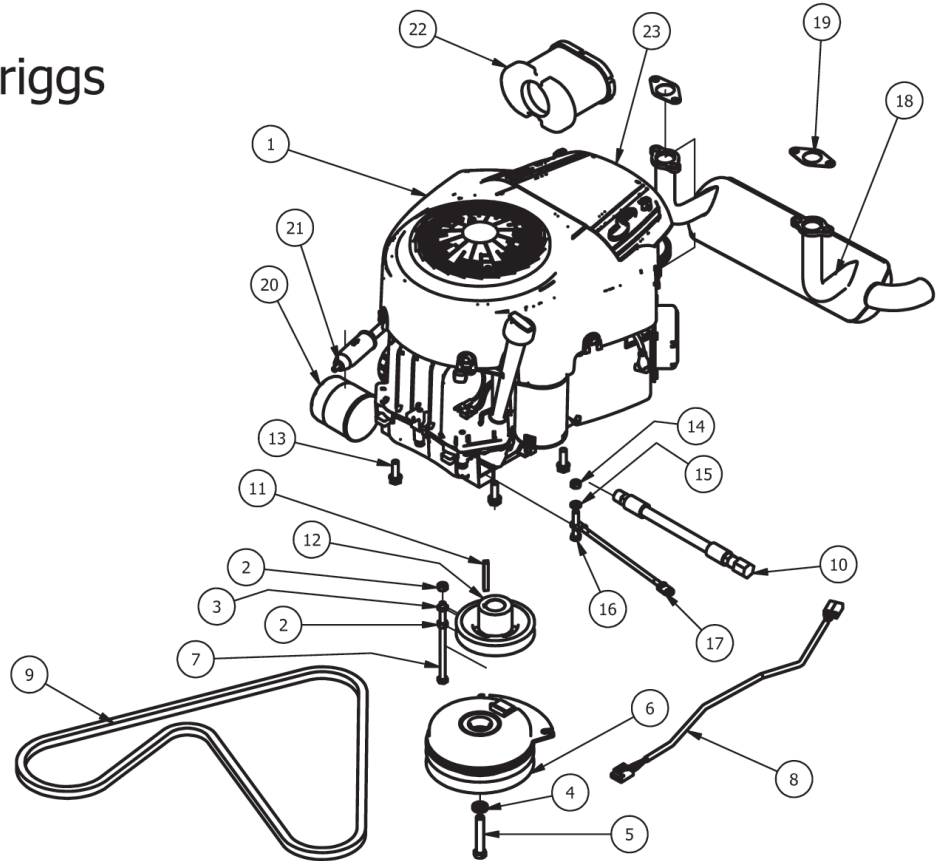

Briggs 27 Hp			
ITEM	QTY	PART NUMBER	DESCRIPTION
1	1	015-3051-00	27Hp Briggs Engine Pro Series
2	2	013-8043-00	5/16" Nut
3	1	019-8051-00	5/16" Lock Washer
4	1	019-8053-00	7/16" Lock Washer
5	1	018-5300-00	7/16" x 2 1/2" Hex Bolt
6	1	070-1000-00	Clutch Assembly
7	1	018-5350-00	5/16-18 x 5-1/2 GR 5 Hex Bolt
8	1	070-2000-00	Clutch Pigtail
9	1	041-6400-00	Pump Belt
10	1	051-5401-00	Oil drain Hose
11	1	042-5020-00	1/4 x 2 Square key Stock
12	1	033-5035-00	4 3/4 Motor Pulley-ZT
13	3	018-1075-00	3/8 x 1 1/8 bolt
14	1	013-8043-00	5/16" Nut
15	1	019-8051-00	5/16" Lock Washer
16	1	018-8059-00	5/16" x 1 3/4" Hex Bolt
17	1	064-8061-00	Ground Cable
18	1	015-0027-00	27 Hp Briggs Exhaust
19	2	015-2751-00	Exhaust Gasket for 27, 30 HP
20	1	063-8018-00	Oil Filter
21	1	063-6000-00	Universal inline Fuel Filter
22	1	063-4000-00	Air Filter W/Cleaner 26 Int
23	1	015-2702-00	26 & 27 Briggs Air Filter Cover

Kawasaki FR-730V

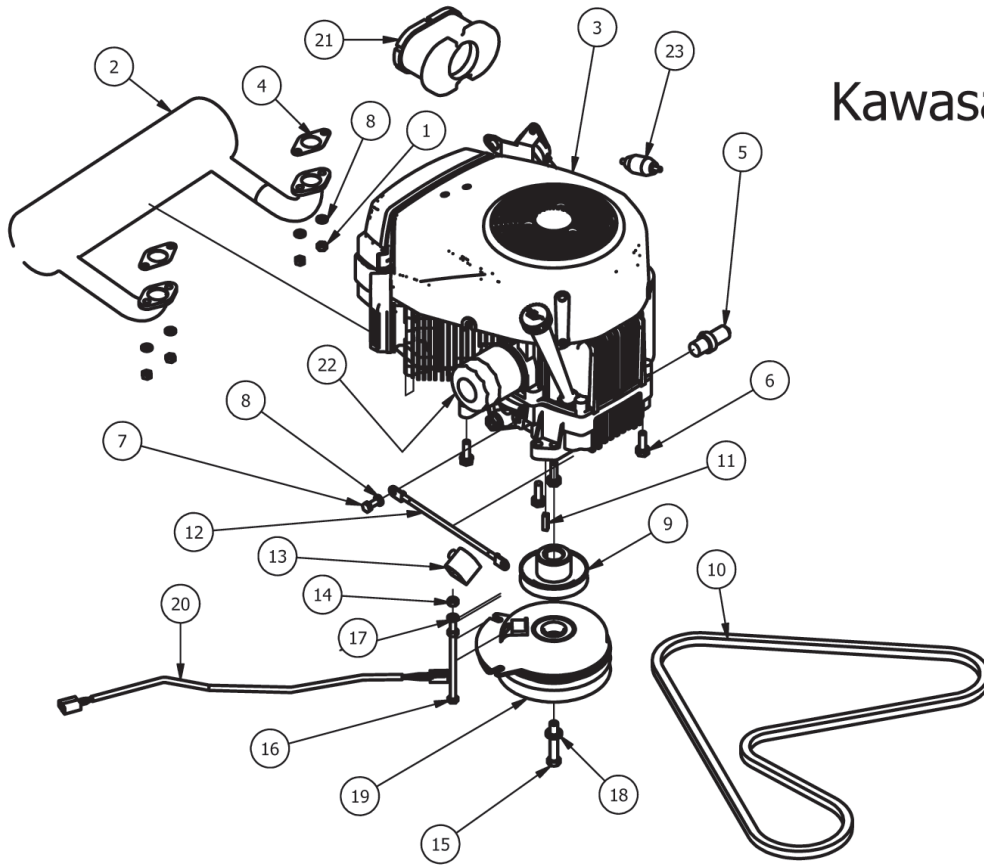

Kawasaki FR-730V			
ITEM	QTY	PART NUMBER	DESCRIPTION
1	4	013-0075-00	M8-1.25 Zinc Nut
2	1	015-0012-00	Kawasaki Exhaust
3	1	015-0090-00	FR730V Kawasaki Engine-1.125" Shaft
4	2	015-2709-00	Exhaust gasket
5	1	015-5404-00	oil drain
6	4	018-1075-00	3/8 x 1 1/8 bolt
7	1	018-5321-00	M8x1.20x20MM Hex head bolt
8	5	019-8051-00	5/16" Lock Washer
9	1	033-2010-00	3-3/4" Motor Pulley
10	1	041-6400-00	Pump Belt
11	1	042-6030-00	1/4" x 1" Key
12	1	064-8061-00	Ground Cable
13	1	103-5400-00	Black Boot For ground cable
14	2	013-8043-00	5/16" Nut
15	1	018-5300-00	7/16" x 2 1/2" Hex Bolt
16	1	018-5350-00	5/16-18 x 5-1/2 GR 5 Hex Bolt
17	1	019-8051-00	5/16" Lock Washer
18	1	019-8053-00	7/16" Lock Washer
19	1	070-1000-00	Clutch Assembly
20	1	070-2000-00	Clutch Pigtail
21	1	063-2097-00	FR-651V & FR730V Kaw air Filter
22	1	063-8017-00	Oil Filter
23	1	063-6000-00	Universal inline Fuel Filter

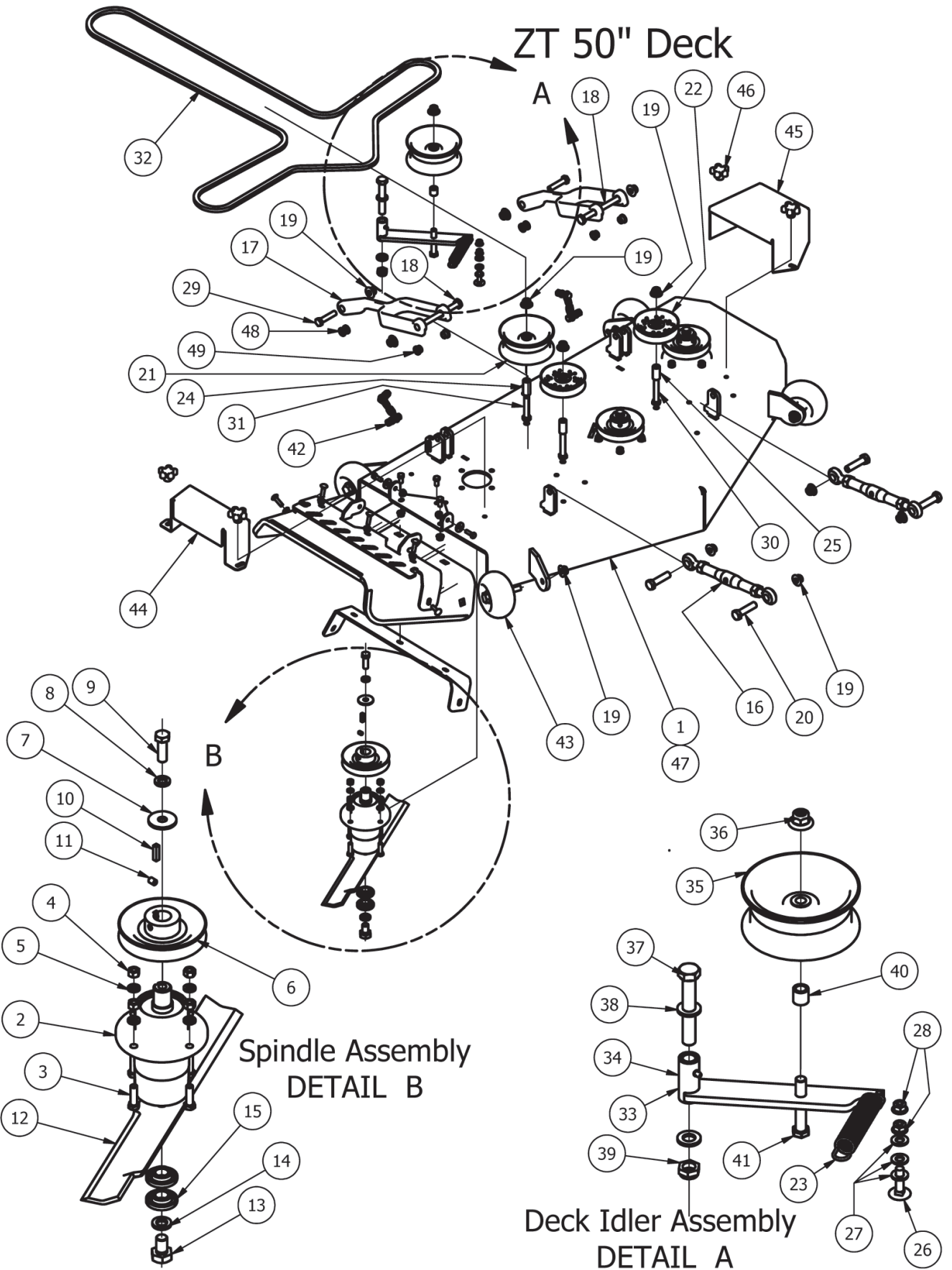

ZT 50" Deck			
ITEM	QTY	PART NUMBER	DESCRIPTION
1	1	060-4800-00	50" Deck Only
2	3	037-6015-50	Spindle - Aluminum - 2012 ZT
3	12	018-5040-00	3/8" x 1 1/4" Hex Bolt
4	12	013-6014-00	3/8" Hex Nut
5	12	019-5037-00	3/8" Lock Washer
6	3	033-6003-00	5" Deck Pulley
7	3	019-6020-00	1/2 Belleville Washer
8	3	019-5007-00	1/2" Lock Washer
9	3	018-6019-00	1/2"-20 x 1 1/2 - Grade 5 Fine Thread Bolt
10	3	042-6030-00	1/4" x 1" Key
11	3	030-6029-00	3/8" Set Screw
12	3	038-5350-00	50 Inch Fusion Blade
13	3	018-6020-00	5/8" x 1 1/2" Grade 8 Bolt
14	3	019-4807-00	5/8" Lock Washer
15	6	037-6023-00	Spindle Bearing
16	2	048-6056-00	Turnbuckle (Top Link)
17	2	031-6010-00	Deck Arm Assembly
18	2	018-1090-00	1/2" x 5 1/2" Bolt
19	14	013-8050-00	1/2-13 Nylon Flange Nut-Orange
20	4	018-6059-00	5/8" x 2 1/2" Hex Bolt
21	1	033-5001-00	5 3/4" Deck Idler Pulley
22	2	033-6001-00	4-3/4 Idler Pulley
23	1	034-9035-00	Deck Idler Spring
24	1	025-5339-00	1 3/4" Pulley Spacer
25	2	025-5338-00	Pup Pulley Spacer
26	1	018-4706-00	3/8 x 1-1/2 Carriage Bolt
27	3	019-5029-00	3/8" Flat Washer
28	2	013-5202-00	3/8" Nylock Flange Nut
29	2	018-6037-00	1/2-13X 2-1/4 GR Hex Bolts
30	2	018-2018-00	1/2 x 3 1/2 Flange Bolt Grade 8
31	1	018-5019-00	1/2" x 4" Bolt (Grade 8)
32	1	041-1470-00	50" Deck Belt
33	1	039-6936-98	Deck Idler Assembly Components 34,35,36,40,41
34	1	039-6936-00	Deck Idler Bracket
35	2	033-5001-00	5 3/4" Deck Idler Pulley
36	1	013-8050-00	1/2-13 Nylon Flange Nut-Orange
37	1	018-5311-00	5/8" x 4" Hex Bolt
38	2	019-6017-00	.635 ID Plastic Washer
39	1	013-5301-00	5/8" Nylock (1/2 Jam)
40	1	025-5203-00	3/4 OD x 1/2 ID x 3\4 Length
41	1	018-7016-00	1/2-13 x GR 5 Hex Bolt Zinc
42	2	047-6050-00	Chain assembly
43	4	022-1000-00	Deck Wheel
44	1	014-4801-00	1/2 Metal Spindle Cover
45	1	014-6004-00	Pulley Cover
46	4	045-6043-00	5/16" Knob
47	1	060-4800-98	50" ZT Deck - Completed Assembly
48	4	032-5057-00	Flange for Lower Deck Arm
49	4	032-5056-00	Flange Bushing For Deck Arm upper



ZT 50" Chute Assembly

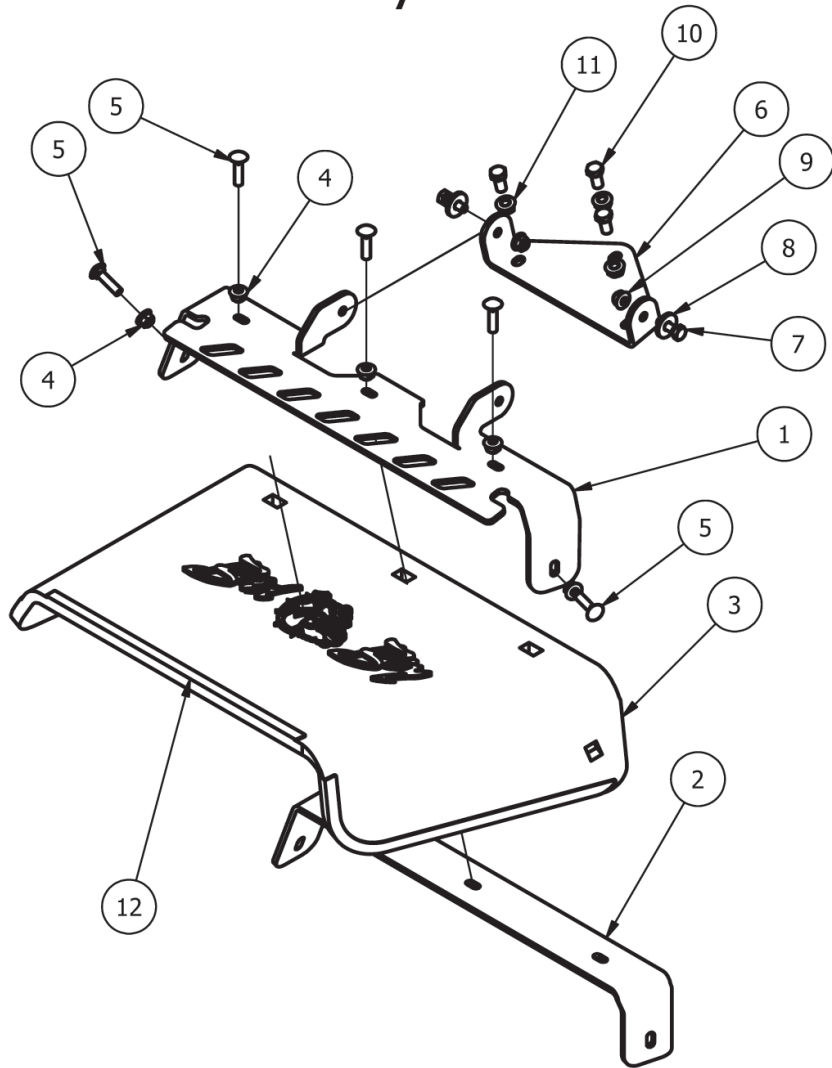

ZT 50" Chute Assembly			
ITEM	QTY	PART NUMBER	DESCRIPTION
1	1	039-4870-00	Upper Hanger
2	1	039-4871-00	Discharge Lower Chute Bracket
3	1	210-6005-00	Rubber Discharge Chute Rubber Only
4	5	013-8049-00	5/16" Nylon Flange Nut
5	5	018-4703-00	5/16" x 1 1/4" Carriage Bolt
6	1	206-6017-00	Discharge Chute Hanger (deck mounted)
7	2	018-2007-00	5/16" x 1" Bolt
8	2	019-6042-00	.360 ID Plastic Washer
9	2	013-8049-00	5/16" Nylon Flange Nut
10	3	018-5250-00	3/8" x 3/4" Hex Bolt
11	3	013-5201-00	3/8" Flange Nut
12	1	210-5218-00	50" Rubber Discharge Chute Assembly Components 1,2,3,4,5

ZT 60" Deck Assembly

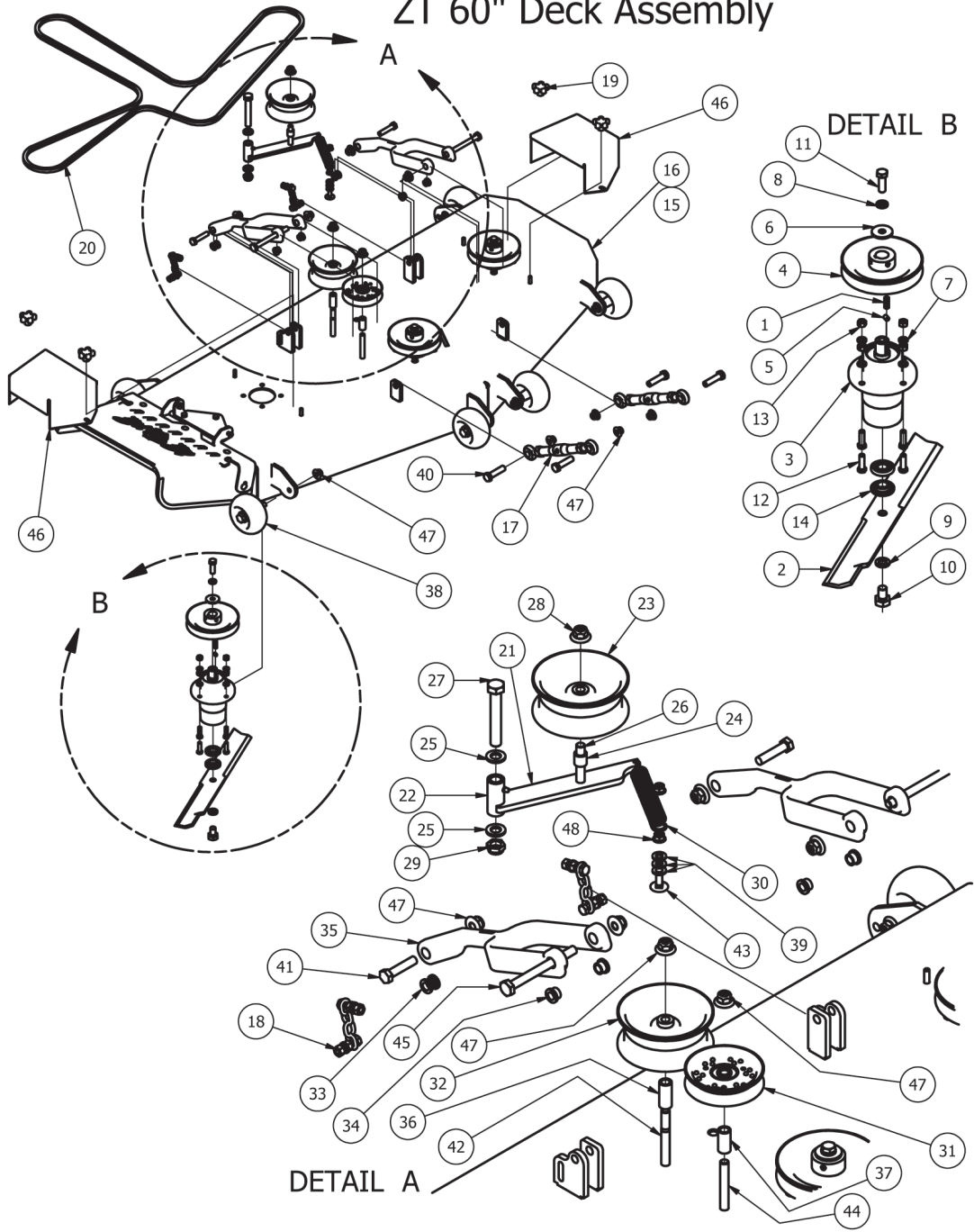



ZT 60" Deck			
ITEM	QTY	PART NUMBER	DESCRIPTION
1	3	042-6030-00	1/4" x 1" Key
2	3	038-6060-00	60 Inch Fusion Blade
3	3	037-6015-50	Spindle - Aluminum - 2012 ZT
4	3	033-6004-00	6 1/4" Drive Pulley
5	3	030-0050-00	5/16 Set Screw
6	3	019-6020-00	1/2 Belleville Washer
7	12	019-5037-00	3/8" Lock Washer
8	3	019-5007-00	1/2" Lock Washer
9	3	019-4807-00	5/8" Lock Washer
10	3	018-6020-00	5/8" x 1 1/2" Grade 8 Bolt
11	3	018-6019-00	1/2"-20 x 1 1/2 - Grade 5 Fine Thread Bolt
12	12	018-5040-00	3/8" x 1 1/4" Hex Bolt
13	12	013-6014-00	3/8" Hex Nut
14	6	037-6023-00	Spindle Bearing
15	1	060-6005-98	60" ZT Deck Complete Assembly
16	1	060-6005-00	60" ZT Deck Only
17	2	048-6056-00	Turnbuckle (Top Link)
18	2	047-6050-00	Chain assembly
19	4	045-6043-00	5/16" Knob
20	1	041-1650-00	60" ZT Deck Belt
21	1	039-6936-98	Deck Idler Assembly components 22,23,24,26,28
22	1	039-6936-00	Deck Idler Bracket
23	1	033-5001-00	5 3/4" Deck Idler Pulley
24	1	025-5203-00	3/4 OD x 1/2 ID x 3\4 Length
25	2	019-6017-00	.635 ID Plastic Washer
26	1	018-7016-00	1/2-13 x GR 5 Hex Bolt Zinc
27	1	018-5311-00	5/8" x 4" Hex Bolt
28	1	013-8050-00	1/2-13 Nylon Flange Nut-Orange
29	1	013-5301-00	5/8" Nylock (1/2 Jam)
30	1	034-2008-00	60" Deck only Deck Idler Spring
31	1	033-6001-00	4-3/4 Idler Pulley
32	2	033-5001-00	5 3/4" Deck Idler Pulley
33	4	032-5057-00	Flange for Lower Deck Arm
34	4	032-5056-00	Flange Bushing For Deck Arm upper
35	2	031-6010-00	Deck Arm Assembly
36	1	025-5339-00	1 3/4" Pulley Spacer
37	1	025-5338-00	Pup Pulley Spacer
38	6	022-1000-00	Deck Wheel
39	3	019-5029-00	3/8" Flat Washer
40	4	018-6059-00	5/8" x 2 1/2" Hex Bolt
41	2	018-6037-00	1/2-13X 2-1/4 GR Hex Bolts
42	1	018-5019-00	1/2" x 4" Bolt (Grade 8)
43	1	018-4706-00	3/8 x 1-1/2 Carriage Bolt
44	1	018-2018-00	1/2 x 3 1/2 Flange Bolt Grade 8
45	2	018-1090-00	1/2" x 5 1/2" Bolt
46	2	014-6010-00	Pulley Cover
47	16	013-8050-00	1/2-13 Nylon Flange Nut-Orange
48	2	013-5202-00	3/8" Nylock Flange Nut

ZT 60" Chute Assembly

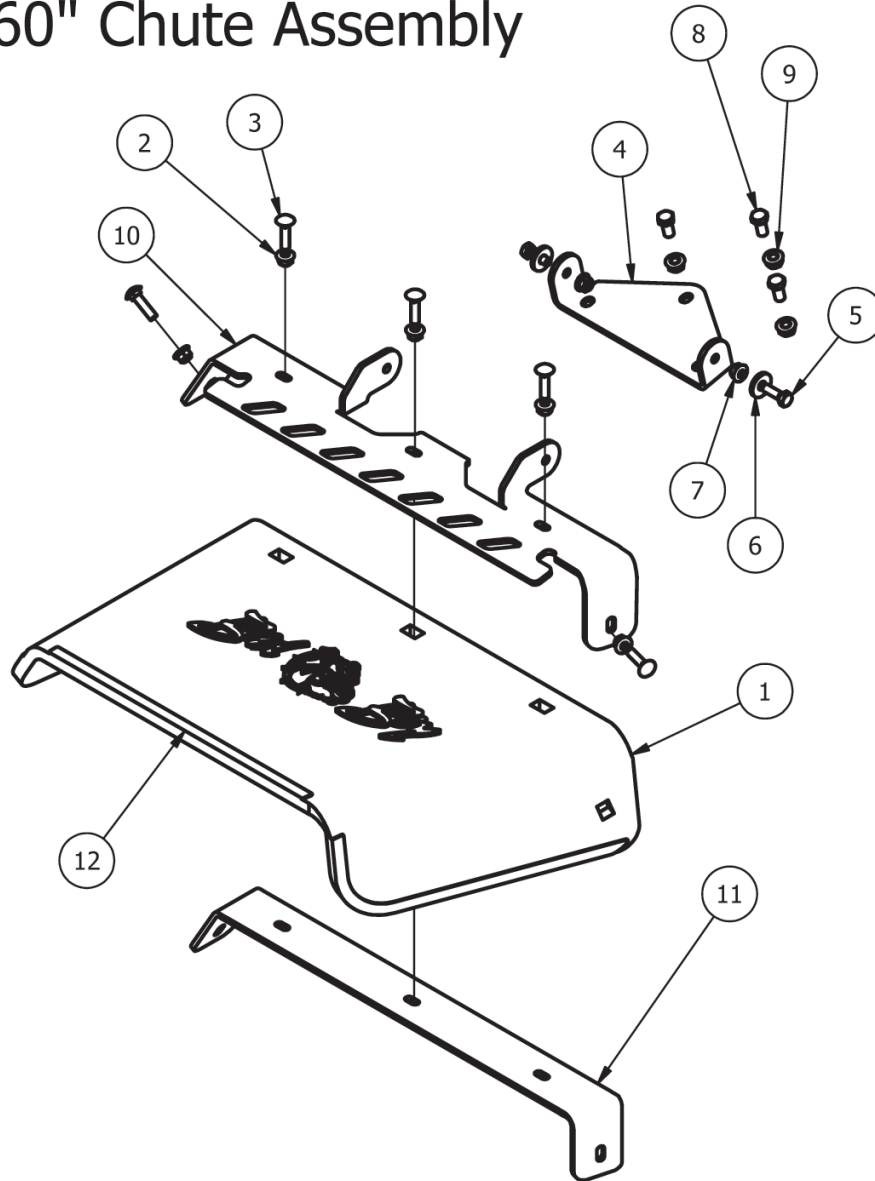

ZT 60" Chute Assembly			
ITEM	QTY	PART NUMBER	DESCRIPTION
1	1	210-6005-00	Rubber Discharge Chute (Rubber Only)
2	5	013-8049-00	5/16" Nylon Flange Nut
3	5	018-4703-00	5/16" x 1 1/4" Carriage Bolt
4	1	206-6017-00	Discharge Chute Hanger (deck mounted)
5	2	018-2007-00	5/16" x 1" Bolt
6	2	019-6042-00	.360 ID Plastic Washer
7	2	013-8049-00	5/16" Nylon Flange Nut
8	3	018-5250-00	3/8" x 3/4" Hex Bolt
9	3	013-5201-00	3/8" Flange Nut
10	1	039-4864-00	60" Upper Hanger Plate
11	1	039-4863-00	60" Lower Hanger
12	1	210-6004-00	60" Rubber Discharge Assembly Components 1,2,3,10,11



091-0726-00
Z 726cc Pro Series Decal



091-3020-00
Z7hp Z-Pro Series Decal



091-3305-00
Lexan Bad Boy Logo Decal-ZT



091-3308-00
50" Deck Decal - ADS

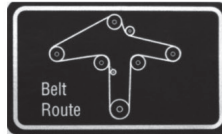

091-3046-00
60" Deck Belt Route Decal

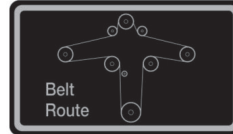

091-3309-00
50" Deck Belt Route Decal

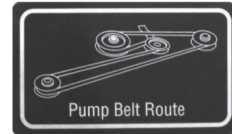

091-3017-00
Pump Belt Route Decal



091-3018-00
60" Deck Decal- ADS



091-3054-00
ZT Steering Speed Control-Left

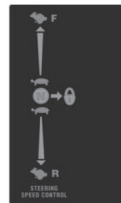

091-3055-00
ZT Steering Speed Control-Right

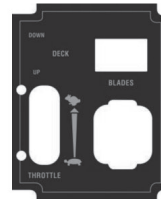

091-3400-00
Instrument Panel Decal-ZT



091-3012-00
Danger Decal- Spindle/Discharge

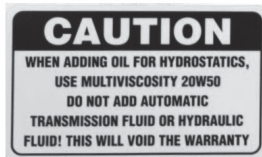

091-3015-00
Caution Decal - hydraulic tank



091-3300-00
Caution Decal-Front Grill

2012 LIMITED WARRANTY FOR BAD BOY ZT MOWERS

1. WHAT THIS WARRANTY COVERS, AND FOR HOW LONG:

Bad Boy, Inc. will, at its option, repair or replace, without charge, any part covered by the warranty which is found to be defective in material and/or workmanship within the lesser of one (1) year* or 200 hours after date of sale to the original retail purchaser unless the product is used for rental purposes, in which case this warranty is limited to thirty (30) days.

The hydrostatic drive components (*transaxle only*), deck spindle assemblies, and the PTO clutch will be warranted for two full years from the date of sale to the original retail purchaser against defects in materials and workmanship. Labor required to repair or replace components of the hydrostatic drive system, deck spindle assemblies, or the PTO clutch will be covered by Bad Boy, Inc. for the first year, and at the unit owner's expense during the second year from the original purchase date.

The leading edge of the deck shell will be warranted for the entire lifetime of the machine to the original purchaser against defects in materials and workmanship. Labor required to repair or replace the leading edge of the deck shell will be covered by Bad Boy, Inc. for the first year and at the unit owner's expense during the balance of the lifetime of the machine.

The Bad Boy ZT Series being used commercially will carry the lesser of a one year or 200 hour warranty, **parts only**. Labor on a Bad Boy ZT Series machine used commercially will not be covered by Bad Boy Inc, and will be the unit owner's responsibility.

Belts are warranted for a period of ninety (90) days against materials or workmanship defects.

At Bad Boy, Inc.'s request, customer will make the defective part available for inspection by Bad Boy, Inc. and/or return the defective part to Bad Boy, Inc., transportation charges prepaid.

Labor required to repair or replace warranted components will be covered for 1 year from the original purchase date, regardless of how much longer the part may be warranted.

2. WHAT THIS WARRANTY DOES NOT COVER:

A. This warranty does not cover defects caused by depreciation or damage caused by normal wear, accidents, improper maintenance, improper use or abuse of the product, alterations, or failure to follow the instruction contained in the Owner's Manual for operation and maintenance.

B. The customer shall pay any charges for making service calls and/or for transporting the mower to and from the place where the inspection and/or warranty work is performed.

Bad Boy Inc will not be responsible for the pickup and delivery of a machine for warranty purposes.

C. **Engines** are warranted separately by their respective manufacturer. The available warranties covering this item are furnished with each mower. Bad Boy, Inc does not assume any warranty obligation, liability or modification for this item, which is covered exclusively by the stated warranty of the respective manufacturers.

D. **Tires, blades, deck anti-scalping wheels, and hoses** are considered to be consumable wear items and are therefore **not warranted**.

E. **Batteries** are warranted for six months (**free replacement**) from the retail purchase date against materials or workmanship defects. **The battery warranty must be obtained through the battery manufacturer.**

3. HOW TO OBTAIN SERVICE UNDER THIS WARRANTY:

A. Warranty service can be arranged by contacting the dealer where you purchased the mower or by contacting Bad Boy, Inc. Proof of the date of purchase may be required to verify warranty coverage.

B. **Warranty claims will not be reviewed or paid unless the warranty registration card is received by Bad Boy, Inc. within 30 days of the retail purchase date.**

4. WARRANTY LIMITATION:

A. **THERE IS NO OTHER EXPRESS WARRANTY. ANY WARRANTY THAT MAY BE IMPLIED FROM THIS PURCHASE INCLUDING MERCHANTABILITY AND FITNESS FOR A PARTICULAR PURPOSE IS HEREBY LIMITED TO THE DURATION OF THIS WARRANTY AND TO THE EXTENT PERMITTED BY LAW ANY AND ALL IMPLIED WARRANTIES ARE EXCLUDED.** Some states do not allow limitations on how long an implied warranty lasts, so the above limitations may not apply to you.

B. **BAD BOY, INC. WILL NOT BE LIABLE FOR ANY INCIDENTAL, CONSEQUENTIAL, OR SPECIAL DAMAGES AND/OR EXPENSES IN CONNECTION WITH THE PURCHASE OR USE OF THE MOWER.** Some states do not allow the exclusion or limitation of incidental or consequential damages, so the above limitation(s) or exclusion(s) may not apply to you.

C. Only the warranty expressed in this limited warranty shall apply and no dealer, distributor, or individual is authorized to amend, modify, or extend this warranty in any way. Accordingly, additional statements such as dealer advertising or presentations, whether oral or written, do not constitute warranties by Bad boy, Inc., and should not be relied on.

D. This warranty extends only to turf equipment operated under normal conditions and properly serviced and maintained. The warranty expressly does not cover (i) any defects, damage or deterioration due to normal use, wear and tear, or exposure; (ii) normal maintenance services such as oil change, cleaning, lubrication, adjustment; (iii) replacement of services, items, such as oil, lubricants, spark plugs, belts, rubber hoses or other items subject to normal service replacement; (iv) damage or defects arising out of or relating to misuse, neglect, alteration, negligence or accident; (v) repair or replacement arising from operation of or use of the turf equipment which is not in accordance with operating instructions as specified in the operator's manual or other operational instructions provided by Bad Boy Inc.; (vi) repair or replacement arising as a result of any operation from turf equipment that has been altered or modified so as to, indetermination of Bad Boy, Inc., adversely affect the operation, performance or durability of the equipment or that has altered, modified or affected the turf equipment so as to change the intended use of the product; (vii) repair or replacement necessitated by use of parts, accessories or supplies, including gasoline, oil or lubricants, incompatible with the turf equipment or other than as recommended in the operator's manual or other operational instructions provided by Bad Boy, Inc.; (viii) repairs or replacements resulting from parts or accessories which have adversely affected the operation, performance or durability of the turf equipment; or (ix) damage or defects due to or arising out of repair of turf equipment by person or persons other than an authorized Bad Boy, Inc., service dealer or the installation of parts other than genuine Bad Boy, Inc., recommended parts.

As a condition to this warranty, customer shall have read the operator's manual and shall have returned to Bad Boy, Inc., within the prescribed time, the enclosed warranty registration card.

E. This warranty gives you specific legal rights, and you may also have other rights, which vary from state to state.



Bad Boy, Inc.
102 Industrial Drive
Batesville, AR 72501
1.866.622.3269
www.badboymowers.com

Technical Support:

Brad Covington brad.covington@badboymowers.com
 Taylor Prince taylor.prince@badboymowers.com
 James Russell james.russell@badboymowers.com

Warranty:

Dustin Tissiere dustin@badboymowers.com

Parts:

Brad Foree brad@badboymowers.com
 Robert Patterson robert.patterson@badboymowers.com

Cut and Mail or Fill Out Online under 'Owners' at www.badboymowers.com

WARRANTY REGISTRATION

Full Name _____

Address _____

City _____

State _____ Zip _____

SERIAL #

Purchase Date _____ Telephone _____

Purchased From _____

"I certify that I have been properly instructed on operating this machine."



For additional information, please see us at
www.badboymowers.com

Bad Boy, Inc.
102 Industrial Drive
Batesville, Arkansas 72501
(870) 698-0090

Cut and Mail or Fill Out Online under 'Owners' at www.badboymowers.com

*Place Stamp
Here*

*POST OFFICE
WILL NOT DELIVER
WITHOUT POSTAGE*



BAD BOY MOWERS

102 Industrial Drive
Batesville, AR 72501