

Quick Start Guide

OontZ

Angle 3 ULTRA

Portable Bluetooth Speaker

Designed and Engineered By
CAMBRIDGE SOUNDWORKS

TheOontZ.com

In the Package

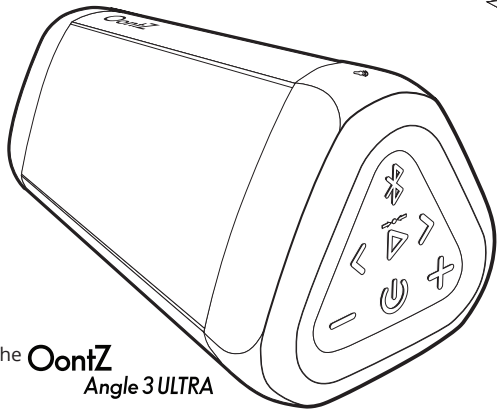

The **OontZ**
Angle 3 ULTRA

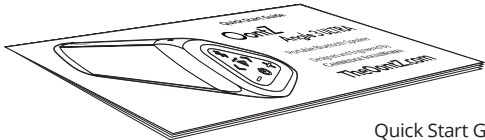

Quick Start Guide

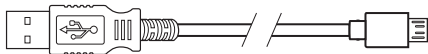

Extra Long 6 foot Micro USB Charging Cable



3 foot 3.5mm Audio Cable

Note: The cables are packed below the cardboard insert in the box. Slide out the insert to locate the cables.

Table of Contents

	Pages
Buttons, Lights and Connectors	1 - 3
Play Horizontally or Vertically	4
Battery Features and Charging the Battery	5 - 7
Turning On and Off	8
Pair & Connect with Your Device	9 - 12
To Play with Non-Bluetooth Devices Use the 3.5mm Audio Cable	13
OontZ Wireless Dual Stereo - Connect two OontZ Angle 3 ULTRA Speakers Together	14 - 18
IPX6 Water Resistant	19
Talk to Siri	20
Wireless Hands Free Personal Speakerphone	20
Contacting Customer Support	21
Safety and Precautions	22 - 23

Buttons

 **Bluetooth (Dual Function)**

 **Track Back**
Press and Release to go to the beginning of the track.
Press and Release twice to go to previous track

 **Volume Down**
Press to decrease volume

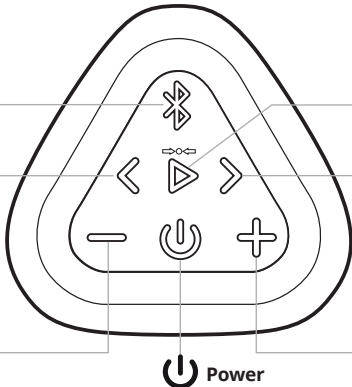

 **Play/Pause**
Press and Release to Pause/Play

 **Track Forward**
Press and Release to go to next track

 **Volume Up**
Press to increase volume

Important - The volume control on your device and the speaker work independently of each other.

To play the speaker at the loudest volume, set the volume on your device to maximum and raise the volume on the speaker to maximum.

Important - Some apps may not support track back, track forward, or play/pause

Lights

Blue Light lit when speaker is on:

- **Flashing Blue**
speaker is in pairing mode
- **Solid Blue**
speaker is connected
- **Blue Light will turn to Solid Green**
when the 3.5mm audio cable is plugged into the AUX IN Jack

Red Light lit when charging:

- **Slowly flashing Red**
battery is charging
- **Solid Red**
battery is fully charged

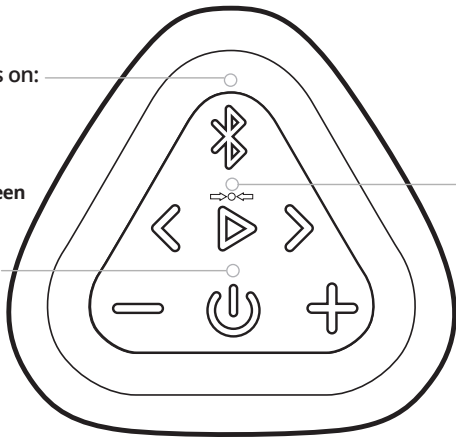

White/Orange Light lit when speaker is in OontZ Wireless Dual Stereo

- With a second OontZ Angle 3 ULTRA speaker (**sold separately**) you can wirelessly connect both speakers together to play with OontZ Wireless Dual Stereo.
- For OontZ Wireless Dual Stereo instructions please see page 14.

Connectors

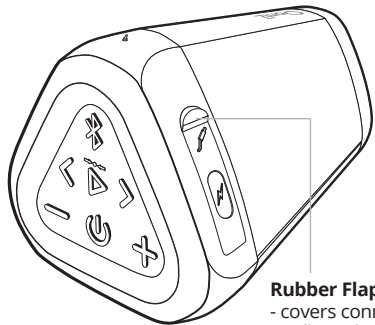

Rubber Flap

- covers connectors
- pull gently from the top to access connectors, it is a snug fit to provide water resistance

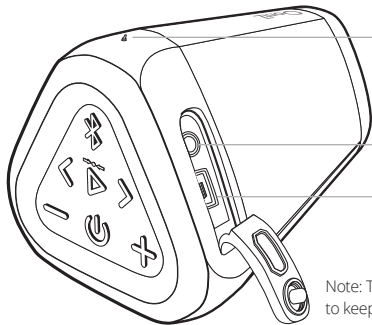

Built-in Mic for Speakerphone

AUX IN Jack

Micro USB Charging Connector

Note: The rubber flap needs to be closed to keep the speaker water resistant

Play Horizontally or Vertically

Play Horizontally
Controls on side

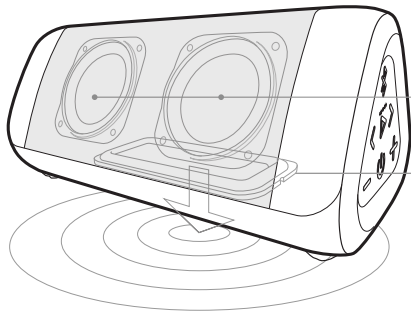

Play Vertically
Controls on top

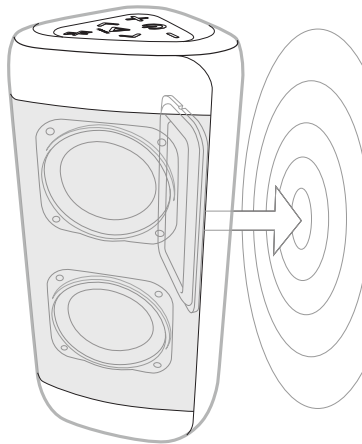

Dual Precision Stereo Drivers

Passive Bass Radiator

Battery Features

- The rechargeable battery comes with a partial charge and the speaker is ready to play.
- For maximum playtime, fully charge the battery.
- You can play while charging.

Low Charge Remaining

- When the battery charge has less than 15% remaining the Red Light will begin flashing rapidly.
- The volume will decrease to preserve the remaining battery charge.

Music Play Time

Up to 20 hours on a full charge, at 2/3 volume.
Louder volumes will reduce the battery play time.

Power Saving Feature

- When playing from battery power the OontZ Angle 3 ULTRA will turn off after 30 minutes of not playing audio to conserve the battery charge. *
- When plugged into a charging source the OontZ Angle 3 ULTRA will remain on until you turn the power off.
- You can continue to keep the speaker plugged into a charging source even when it is fully charged, keeping the speaker turned on and available

*Exception: when connected to certain devices, including the Amazon Echo Dot or Amazon Echo, the **Power Saving Feature** is disabled and the speaker will remain on until you turn the power off.

Charging the Battery

Red Light lit
when charging:

- **Slowly flashing Red**
battery is charging
- **Solid Red**
battery is fully charged

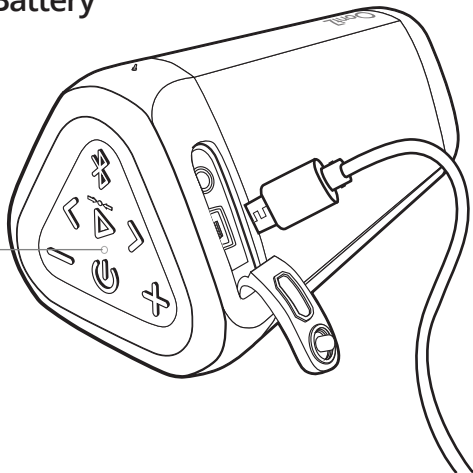

- Insert the small end of the Micro USB Charging Cable into the Micro USB Charging Connector as shown.
- Insert the large end of the Micro USB Charging cable into either a USB wall charger for a Smartphone or iPhone, or a USB port on your laptop/computer to charge the battery (see illustrations on page 7).

Charging Time:

- Up to 7 hours to fully charge a low battery.

Charging the Battery (continued)

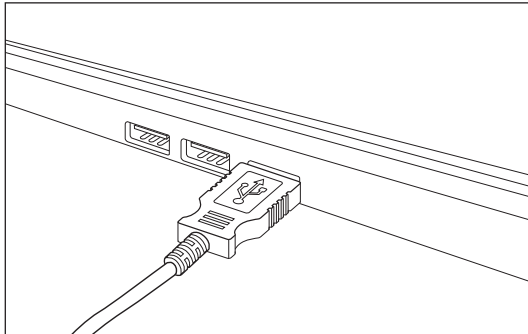
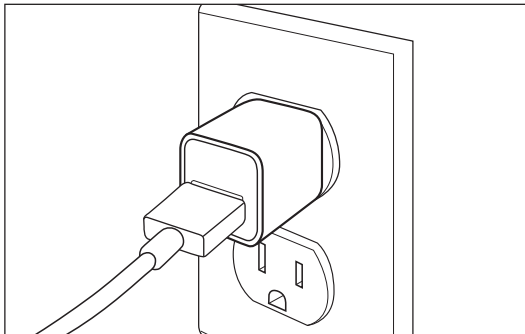

Insert the large end of the Micro USB charging cable into either a USB wall charger for a Smartphone or iPhone (a USB wall charger that is 5V $\overline{\text{---}}$ 1.0A up to 5V $\overline{\text{---}}$ 2.4A maximum) or a USB port on your laptop/computer to charge the OontZ Angle 3 ULTRA rechargeable battery.

Turning On and Off

Turn ON

Press and Release
the Power Button 

Red Light will turn
on for 3 seconds

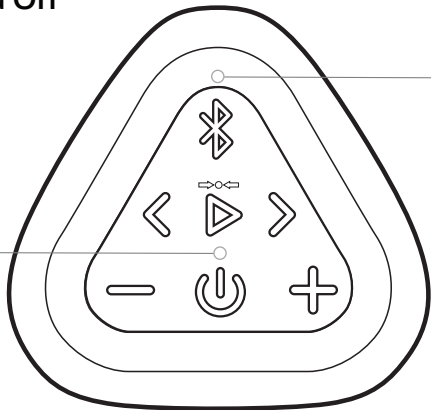

Blue Light will turn on
after Red Light turns off

- Flashing Blue

The speaker is in pairing mode

- Solid Blue

Your device has connected with the
OontZ Angle 3 ULTRA and is ready to play

Turn OFF

Press and Hold Down the Power Button 
for 2 Seconds

Blue Light will turn off

Pair & Connect -- Step 1

Turn ON your OontZ Angle 3 ULTRA

Flashing Blue Light

- The OontZ Angle 3 ULTRA is ready to pair and connect.

Solid Blue Light

- Your device has connected to the OontZ Angle 3 ULTRA and is ready to play.
- The OontZ Angle 3 ULTRA allows the last device it was connected with to automatically reconnect with the speaker, each time you turn the speaker on and that device is within range.*

The OontZ Angle 3 ULTRA can be connected to one device at a time.

- To pair and connect to a different device, you need to first disconnect the currently paired device.
- To disconnect the current device, press and hold down the **Bluetooth button**  for 5 seconds.
- The **Blue Light** will begin **flashing** and the OontZ Angle 3 ULTRA is ready for the next device to pair and connect.

*Exception: certain devices may not automatically reconnect.

Amazon Echo devices will not automatically reconnect. You will need to say "Alexa, connect my speaker"

- Your device needs to be within 100 unobstructed feet of the OontZ Angle 3 ULTRA to pair and connect.
If there is an issue when connecting please move your device closer to the speaker, then pair and connect.
- When the charge is too low indicated by a flashing red light on the speaker, your device will not be able to connect with the speaker.

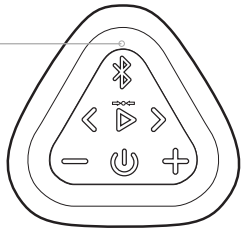

Pair & Connect with Your Device -- Step 2 --

-- With Your iPhone, iPad, or iPod

- Go to Settings > Bluetooth, check Bluetooth is on
- Select 'OontZ_Angle 3 Uxxx' when it appears under DEVICES (xxx: 3 characters which are unique to your speaker)
- Your device will connect in a few seconds
- The **Blue Light** will turn solid blue and there will be a quiet chime
- You can now play your audio wirelessly to your OontZ Angle 3 ULTRA

-- With Your Smartphone, Tablet & Mobile Devices

- Go to Settings > Bluetooth, check Bluetooth is on
 - Scan or Search and select 'OontZ_Angle 3 Uxxx' when it appears under AVAILABLE DEVICES (xxx: 3 characters which are unique to your speaker)
 - Your device will connect in a few seconds
 - The **Blue Light** will turn solid blue and there will be a quiet chime
 - You can now play your audio wirelessly to your OontZ Angle 3 ULTRA
- Note: Your Smartphone or Tablet instructions may vary

Important - The volume control on your device and the speaker work independently of each other. To play the speaker at the loudest volume, set the volume on your device to maximum and raise the volume on the speaker to maximum.

-- With Your Apple Mac or Windows Laptop/Computer

For the pairing and connecting guide for your Apple Mac or Windows laptop/computer, please visit: TheOontZ.com/pairing

Pair & Connect with Your Device -- Step 2 --

-- From Your Amazon Echo or Amazon Echo Dot

To pair and connect with the Amazon Echo or Amazon Echo Dot the first time use the Alexa app. For other Amazon Alexa devices please refer to their pairing and connecting instructions.

- Open the Alexa app
- Go to the 'Home' menu by pressing the 3 horizontal lines in the upper left corner next to 'Home'
- Press 'Settings'
- Select your Amazon Echo device under 'Devices' by pressing it
- Press 'Bluetooth'
- Select the 'OontZ_Angle 3 Uxxx' (xxx: 3 characters unique to your speaker) when it appears in the list of 'Available Speakers'
- Alexa will announce: "Connected to OontZ_Angle 3 Uxxx"

To connect the next time, turn on the OontZ Angle 3 ULTRA and say "Alexa, connect my speaker" or "Alexa, pair"

Pair & Connect with Your Device -- Step 2 --

-- With Your Amazon Echo or Amazon Echo Dot (continued)

Important Note: When the OontZ Angle 3 ULTRA is playing from battery power and connected to the Amazon Echo device, the speaker will remain on and it will not automatically turn off after 30 minutes of not playing audio. This will use up the battery charge.

We recommend to:

- 1) Keep the OontZ Angle 3 ULTRA plugged into a USB wall charger and it will remain on and available to play from the Amazon Echo device until you manually turn the speaker power off.
 - Or -
- 2) Turn off the OontZ Angle 3 ULTRA when you are done listening.
 - Either turn off the speaker by pressing and holding down the power button  for 2 seconds,
 - or say "Alexa, disconnect my speaker" and the OontZ Angle 3 ULTRA will automatically turn off after 30 minutes.
 - When you want to connect and play to the speaker again turn on the OontZ Angle 3 ULTRA and say "Alexa, connect my speaker" or "Alexa, pair".

For assistance with the Alexa app, contact Amazon's Customer Service.
Open the Alexa app and select Help & Feedback > Email Customer Service

To Play with Non-Bluetooth Devices Use the 3.5mm Audio Cable

Turn ON your OontZ Angle 3 ULTRA 

- Plug one end of the 3.5mm audio cable into the **AUX IN Jack** on the speaker.
- The Blue Light will turn solid Green.
- Plug the other end of the 3.5mm audio cable into the headphone jack on your device.
- Make sure both ends of the cable are fully inserted
- You are now ready to play.

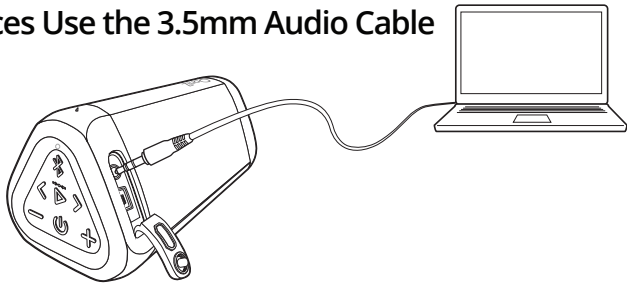

Important: The Bluetooth on the OontZ Angle 3 ULTRA is disabled when the 3.5mm audio cable is connected to the speaker. You need to remove the 3.5mm audio cable from the speaker in order to connect to a Bluetooth device.

- Note: When the rubber flap is open to allow the 3.5mm audio cable to be connected, the speaker is not water resistant. The rubber flap needs to be closed to keep the speaker water resistant.
- Note: The volume control on your device and the speaker work independently of each other. To play the speaker at the loudest volume, set the volume on your device to maximum and raise the volume on the speaker to maximum.

OontZ Wireless Dual Stereo - Connect two OontZ Angle 3 ULTRA speakers together

Play your music wirelessly through both speakers up to 100 feet apart*

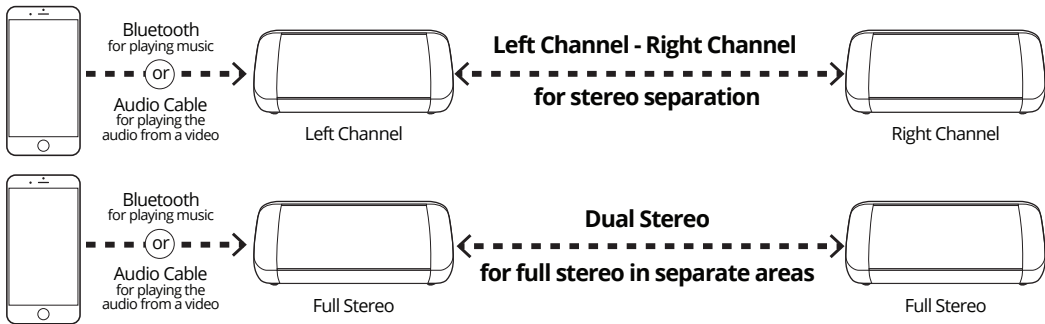

*Placing the speakers on the ground or having walls or obstructions between the speakers will significantly reduce the distance apart the two speakers can play together

Connecting two OontZ Angle 3 ULTRA Speakers together for Left Channel - Right Channel

- Turn on both OontZ Angle 3 ULTRA speakers. 
- Pair and Connect one of the speakers with your device. When connected the Blue Light will be lit solid. This speaker will serve as the **Play Control Speaker**.
- The second speaker must not be connected to any device, its Blue Light needs to be flashing. If the second speaker has a solid Blue Light it is connected to a device and you need to disconnect it, by pressing and holding down the **Bluetooth button**  for 5 seconds until the Blue Light begins flashing.
- On the **Play Control Speaker** (speaker with solid Blue Light) press and hold down the **Play/Pause button**  for 5 seconds until the flashing White Light appears and the speaker says "Dual Pairing".
- The **Play Control Speaker** will then connect to the second speaker. This can take a few seconds. The **Play Control Speaker** will say "Left Channel" and the second speaker will say "Right Channel" and the speakers will be connected together for Left Channel - Right Channel and you are ready to play.

Two OontZ Angle 3 ULTRA Speakers connected for Left Channel - Right Channel

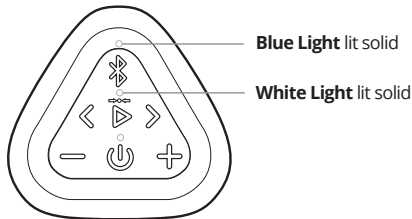

Play Control Speaker

- Use the buttons on the **Play Control Speaker** for play/pause, track back, track forward, answer and end phone calls. These controls are disabled on the second speaker when paired together.
- Use the **Play Control Speaker** for connecting to different audio devices via Bluetooth or AUX IN. The Bluetooth and AUX IN are disabled on the second speaker when paired together.
- Speakerphone call audio will only play through the **Play Control Speaker**

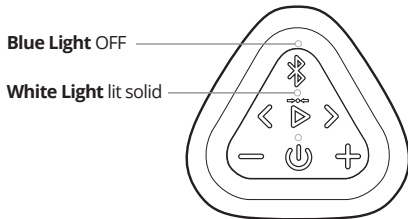

Second Speaker

Changing to Dual Stereo from Left Channel - Right Channel

Use Dual Stereo when placing the two speakers in different areas, and both speakers will play in full stereo.

- To set both speakers for Dual Stereo they must first be connected together for Left Channel - Right Channel (see page 15).
- With the speakers connected together for **Left Channel - Right Channel**, you can change the speakers to **Dual Stereo**.
- To change to Dual Stereo, press and hold down the **Track Forward button** > on the **Play Control Speaker** for 5 seconds until the White Lights turn solid Orange on both speakers.
- Both speakers will say "Dual Stereo" and you are ready to play.

Changing back to Left Channel - Right Channel from Dual Stereo

- To change back to Left Channel - Right Channel, press and hold down the **Track Forward button** > on the **Play Control Speaker** for 5 seconds until the Orange Lights turn solid White on both speakers.
- The **Play Control Speaker** will say "Left Channel" and the second speaker will say "Right Channel" and you are ready to play.

OontZ Wireless Dual Stereo - Important Notes

Turning the speakers off

- Turning the **Play Control Speaker** off will turn both speakers off.
- Turning the second speaker off first will only turn that speaker off and the **Play Control Speaker** will play as a single speaker.

Turning the speakers back on

- Turn both speakers on and they will automatically try to connect to each other again.
- Turn one of the speakers on and a device can connect with it, and play as a single speaker.

Disconnecting the two speakers from each other

- Both speakers need to be turned on.
- On the **Play Control Speaker** press and hold down the **Play/Pause button**  for 5 seconds. The White Lights will turn off and the speakers will be disconnected from each other.

Playing the audio from a video in OontZ Wireless Dual Stereo

- To play the audio from a video or TV in OontZ Wireless Dual Stereo you will need to connect the **Play Control Speaker** to your device or TV using the 3.5mm audio cable, allowing the audio and video to play in sync with each other. If the **Play Control Speaker** is connected over Bluetooth to your device or TV there will be a delay in the audio playback from a video.

IPX6 Water Resistant

No more worries about the rain or getting splashed

Perfect for taking to the beach or by the pool

The rubber flap needs to be closed to keep the speaker water resistant and dustproof

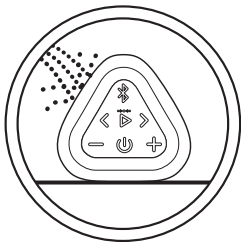

Gentle Water Spray or Splash is okay



DO NOT allow speaker to sit in water



DO NOT allow speaker to submerge fully or partially in water

Safety Precaution: When the OontZ Angle 3 ULTRA speaker is plugged in to a charging source with the Micro USB charging cable, never use the speaker in the shower, bath, or near water, to prevent risk of electric shock.

IPX6 rating - The OontZ Angle 3 ULTRA can resist water spray & splash but cannot be partially or fully submerged or left in a wet environment for an extended period of time, any of which could cause unreparable damage to the speaker.

When charging or using the 3.5mm audio cable, please keep the speaker away from water as it can be damaged by water entering the connectors.

Talk to Siri on your iPhone or iPad through the OontZ Angle 3 ULTRA

This feature works when connected to an iPhone or an iPad over Bluetooth.

To talk to Siri through the OontZ Angle 3 ULTRA

- Press and Release the Bluetooth Button  on the OontZ Angle 3 ULTRA
- The blue light will turn to green and flash 3 times
- Wait for about two seconds until you hear a "chime"
- After the "chime" say what you need into the mic on the OontZ Angle 3 ULTRA
- The response from Siri will then play through the OontZ Angle 3 ULTRA, and may display information on your iPhone or iPad

Your iPhone or iPad needs to be on the latest version of iOS

Wireless Hands Free Personal Speakerphone

The Wireless Hands Free Personal Speakerphone feature works over Bluetooth with Smartphones and iPhones only; this feature is not supported when connected to other types of devices.

To answer an Incoming Call / To End a Call

- Press and Release the Bluetooth Button 

To Reject an Incoming Call

- Press and Hold Down the Bluetooth Button  for 2 Seconds
- Please keep the speaker close in front of you so you may be heard clearly by the listener.
- You can use your Smartphone or iPhone to switch between using Hands Free Speakerphone and your phone.
- When two speakers are paired together in **OontZ Wireless Dual Stereo**, calls will come through the **Play Control Speaker** only. Use the Bluetooth button  on the **Play Control Speaker** for the speakerphone functions. For more information on **OontZ Wireless Dual Stereo** please see page 14.

Customer Support

If you have a question about your OontZ Angle 3 ULTRA or experience an issue with the speaker, our Customer Support Team wants to assist you.

For online troubleshooting tips please visit:

TheOontZ.com/troubleshooting

and select the OontZ Angle 3 ULTRA

Contact us at:

TheOontZ.com/support

and fill in our customer support form

Reset Function

Step 1: Remove the Micro USB charging cable and 3.5mm Audio cable, if connected.

Step 2: Press and hold down the **Power button**  for approximately 15 seconds until the white and green lights come on together and then turn off together, then release the Power button.

Step 3: The speaker has now been reset and you can turn it on.

Safety and Precautions

- 1. When the OontZ Angle 3 ULTRA speaker is plugged in to a charging source with the Micro USB charging cable, never use the speaker in the shower, bath, or near water, to prevent risk of electric shock.**
2. Read and follow all instructions – All operating and use instructions should be followed.
3. Protect the Micro USB charging cable from being pinched, particularly at the connectors.
4. Unplug the Micro USB charging cable during lightning storms or when unused for long periods of time.
5. Do not place speaker near any heat sources such as radiators, heat registers, stoves, or other apparatus (including amplifiers) that produce heat.
6. Refer all servicing to qualified personnel. Servicing is required when the speaker has been damaged in any way.
7. Do NOT make unauthorized alterations to this speaker.
8. Use this speaker only with an agency approved power supply which meets local regulatory requirements (e.g., UL, CSA, VDE, CCC) in accordance with the manufacturer's specifications.
9. Do NOT place naked flame sources, such as lighted candles, on or near the speaker.
10. Do not expose products containing batteries to excessive heat (e.g. from storage in direct sunlight, fire or the like)
11. If the battery leaks, do not allow the liquid to come in contact with the skin or eyes. If contact is made, seek medical advice.

Apple, iPhone, iPad, iPod, Mac and Siri are registered trademarks of Apple Inc.
Amazon, Alexa, Amazon Echo and Amazon Echo Dot are registered trademarks of Amazon.com, Inc.
Windows is a registered trademark of Microsoft Corporation
Bluetooth is a registered trademark of Bluetooth SIG, Inc.

Safety and Precautions (continued)

This device complies with Part 15 of the FCC Rules. Operation is subject to the following two conditions:

(1) This device may not cause harmful interference, and (2) this device must accept any interference received, including interference that may cause undesired operation.

NOTE 1: This equipment has been tested and found to comply with the limits for a Class B digital device, pursuant to part 15 of the FCC Rules. These limits are designed to provide reasonable protection against harmful interference in a residential installation. This equipment generates, uses and can radiate radio frequency energy and, if not installed and used in accordance with the instructions, may cause harmful interference to radio communications. However, there is no guarantee that interference will not occur in a particular installation. If this equipment does cause harmful interference to radio or television reception, which can be determined by turning the equipment off and on, the user is encouraged to try to correct the interference by one or more of the following measures:

- Reorient or relocate the receiving antenna.
- Increase the separation between the equipment and receiver.
- Connect the equipment into an outlet on a circuit different from that to which the receiver is connected.
- Consult the dealer or an experienced radio/TV technician for help.

NOTE 2: Any changes or modifications to this unit not expressly approved by the party responsible for compliance could void the user's authority to operate the equipment.

OontZ Angle 3 ULTRA Carry Case

Sold separately

- Lightweight neoprene rubber with reinforced zipper
- Includes a durable aluminum carabiner for easily attaching to backpacks, luggage, laptop bags, coolers, camera bags, purses, belts, and other clippable items

Available at TheOontZ.com



OontZ Wireless Dual Stereo

With a second OontZ Angle 3 ULTRA speaker you can wirelessly connect both speakers together



Left Channel

Incredible Stereo Separation



Up to 100 feet apart



Right Channel

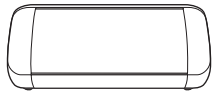

Full Stereo

Full Stereo in Separate Areas



Connect with a friend's OontZ Angle 3 ULTRA
or purchase a second OontZ Angle 3 ULTRA, sold separately at TheOontZ.com

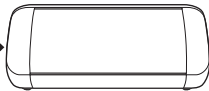

Full Stereo

Available at TheOontZ.com