

Garden Bundle

Assembly Instructions



Difficulty
HARD

Before starting this kit, make sure you read through all the instructions carefully. Always remember to dry fit parts and sand as needed.

We use two kinds of glue when assembling our kits. Super glue (cyanoacrylate) or PVA glue.

You can repaint or weather our kits easily! The paint we use is a great base primer and will take paint nicely.

If you have any issues during assembly, please contact us and we'll always do our best to help. We pride ourselves on taking care of our customers, so if you need anything at all, we're here!

As part of the laser cutting process, some colors or sheets may have more laser dust/residue than others. This is due to a wide variety of reasons and its 100% normal.

If the smell bothers you, set the kits outside for a day or so. If the residue is getting onto your hands, use some gloves!

Some folks like to wipe the kits down with a very lightly damp rag.

IMPORTANT SYMBOLS YOU MAY FIND WHILE ASSEMBLING THESE KITS



ATTENTION: This is a specifically important step.

NO GLUE: When you need to place a part without glue. Working doors are a good example



USE GLUE: This one isn't used much, as we assume almost all steps will have glue. But sometimes we use this for additional clarity



TRIM/SAND: Sometimes parts need to be slightly sanded, or trimmed in order to get the perfect fit.



DRY FIT: Sometimes we'll tell you to test fit items first. While we suggest doing this for ALL steps. Some are more important.

Modern Miniatures

Horror Miniatures

Avalon

World Leader Miniatures

Adepticon Miniatures

Spectre Miniatures

Modern Vehicles



TOOLS WE SUGGEST YOU HAVE BEFORE GETTING STARTED



SAND PAPER



CUTTERS



SMALL FILES



SUPER GLUE



WHITE GLUE



CLAMPS OR PEGS

THIS KIT IS NOT A TOY - NOT FOR CHILDREN UNDER 15 - CONTAINS SMALL PARTS - PERMISSION TO PRINT THESE FOR PERSONAL USE ONLY THIS KIT IS NOT A TOY - NOT FOR CHILDREN UNDER 15 - CONTAINS SMALL PARTS - PERMISSION TO PRINT THESE FOR PERSONAL USE ONLY

Garden Bundle

Sheet Breakdown



IF YOU ARE MISSING ANY SHEETS, OR HAVE DEFECTIVE PARTS. FOLLOW THE QR CODE ON THE RIGHT AND SUBMIT A TICKET WITH OUR TEAM. WE'LL GET YOU SORTED!



SCAN ME

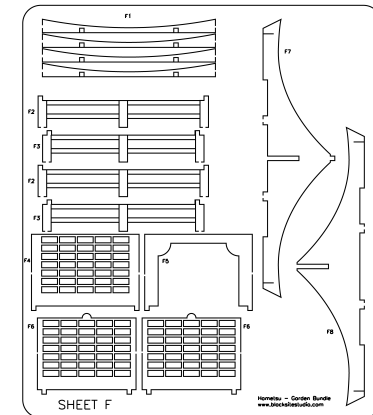
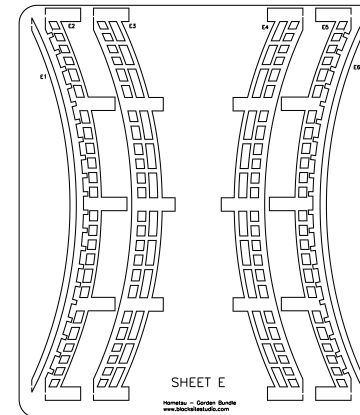
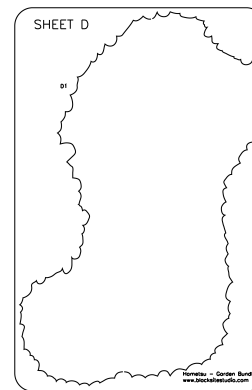
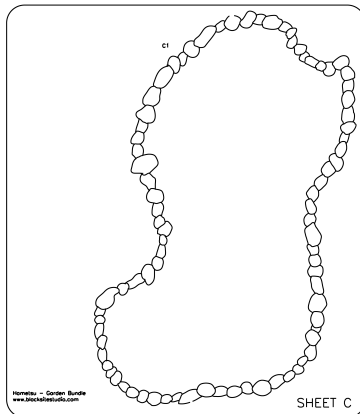
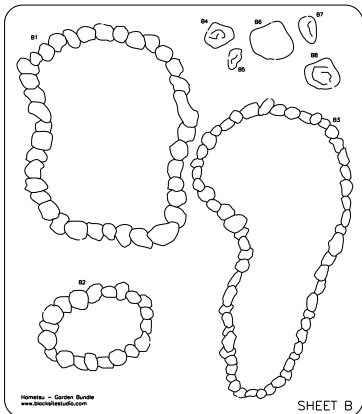
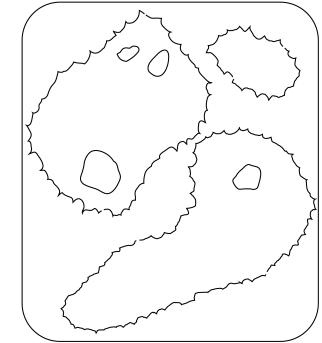
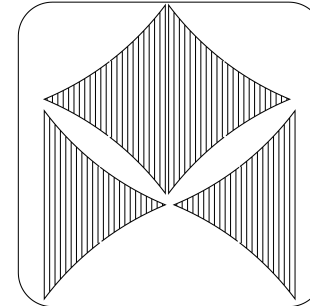
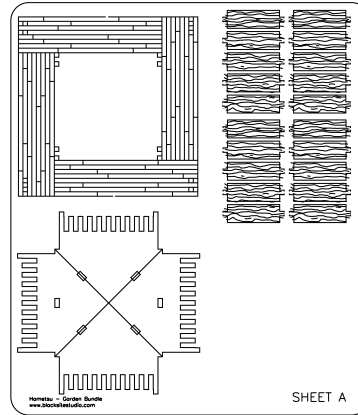
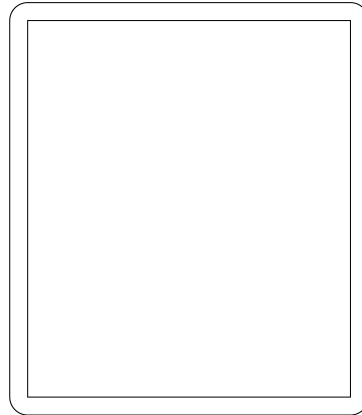
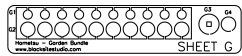

EXTRA PARTS:

SOMETIMES OUR KITS MAY COME WITH ADDITIONAL PARTS, GREEBLIES OR FREE DETAILS. WE DON'T ALWAYS SHOW THESE PARTS AS PART OF THE INSTRUCTIONS BECAUSE THEY MAY SOMETIMES CHANGE BETWEEN EDITIONS OR MANUFACTURING RUNS.

IF YOU GET TO THE END OF THIS KIT AND THERE ARE PARTS LEFT OVER, SIMPLY DISCARD THEM, OR USE THEM TO KITBASH SOME COOL ADDITIONAL FLAVOR TO YOUR KIT!

ADDENDUM SHEETS:

SOMETIMES BEFORE A KIT GOES OUT IN THE MAIL, OUR TEAM WILL CATCH A FEW MINOR ERRORS. THIS KIT COMES WITH SOME EXTRA ADDENDUM SHEETS.

IF YOUR KIT COMES WITH THESE SHEETS THEN MAKE SURE TO USE THE PARTS ON THEM INSTEAD OF THE ONES ON THE MAIN LARGER SHEETS.

IF YOUR KIT DOES NOT COME WITH ANY ADDENDUM SHEETS THEN YOU'RE GOOD TO GO!



Step 1:

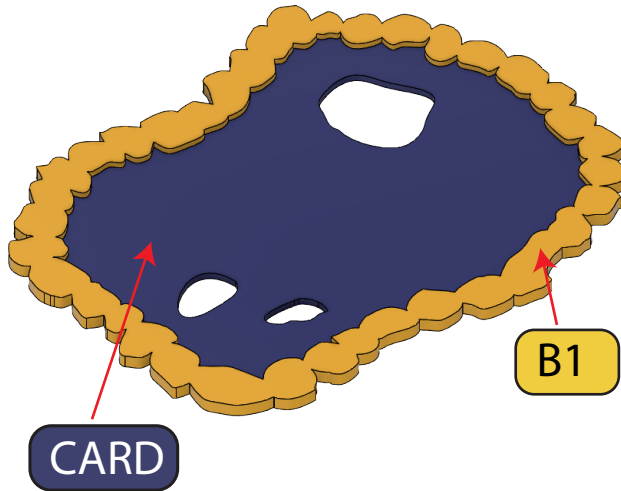

Step 2:

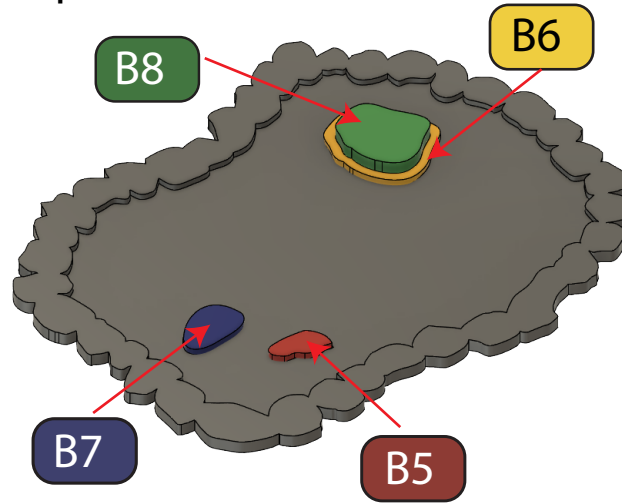

Step 4:

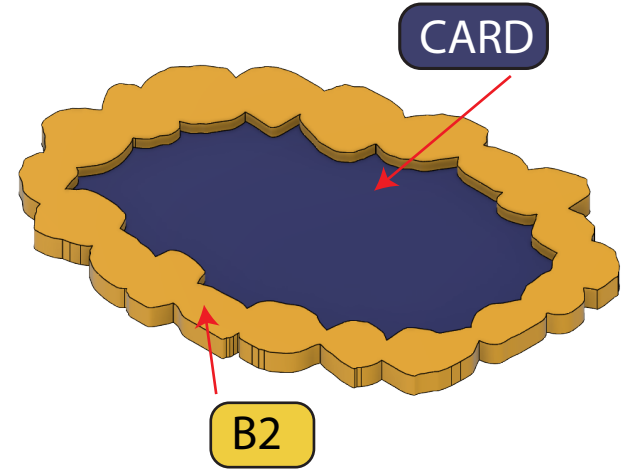

Step 3:

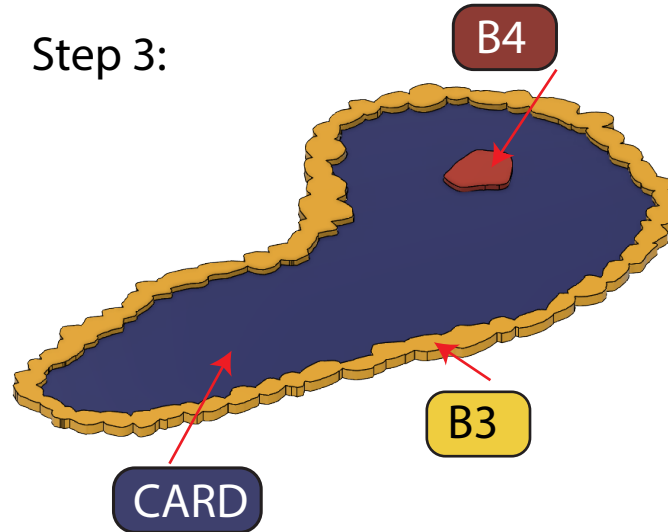

Step 5:

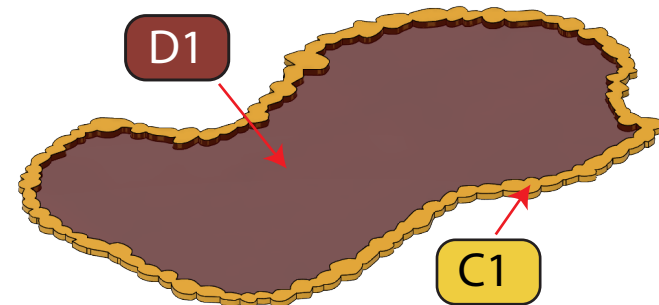



Step 6:

2x

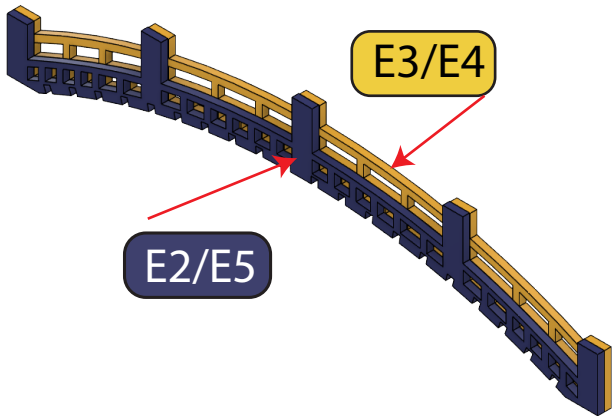

Step 7:

2x

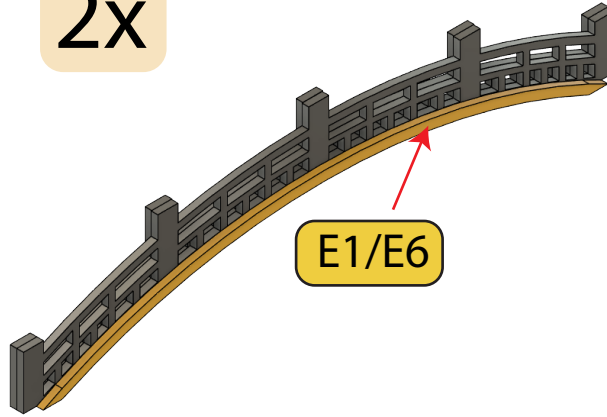

Step 8:

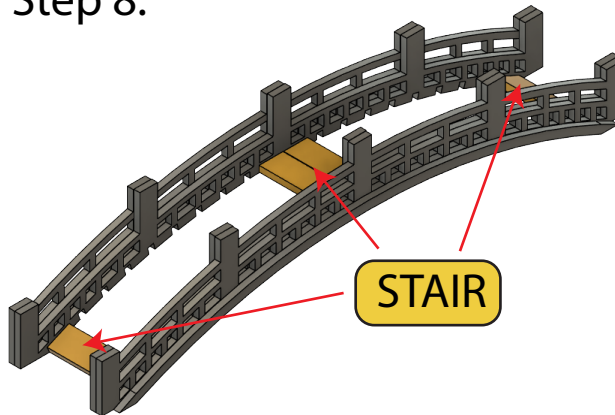

Step 9:

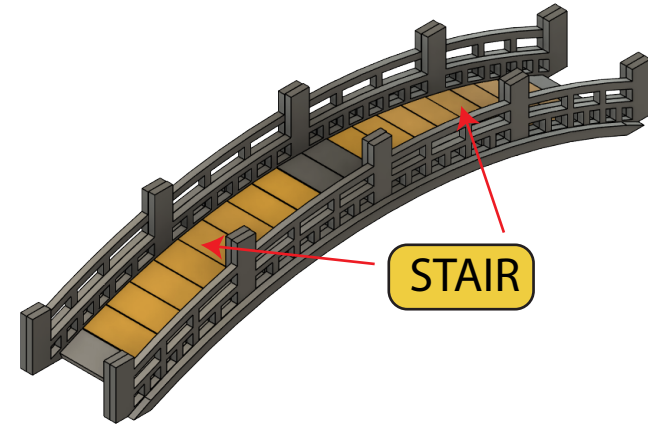

Step 10:

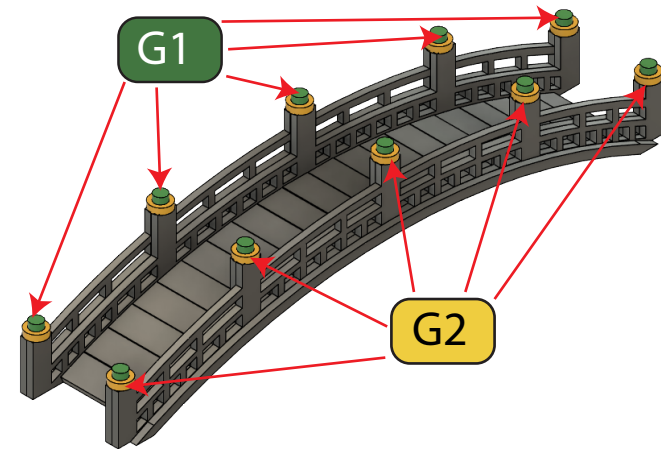



Step 11:

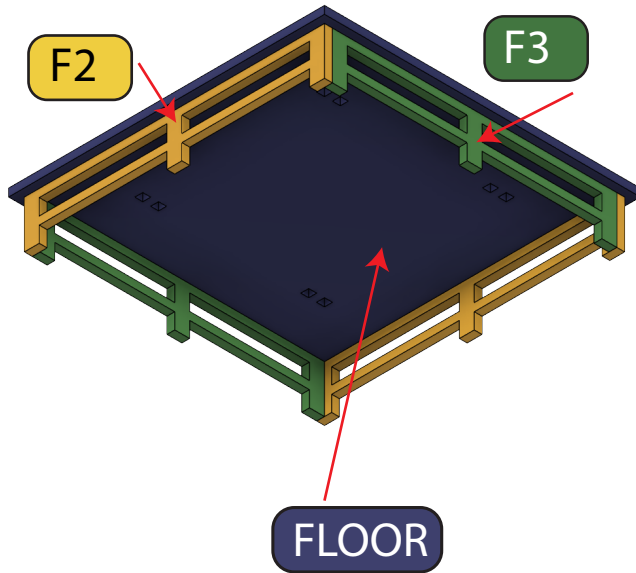

Step 12:

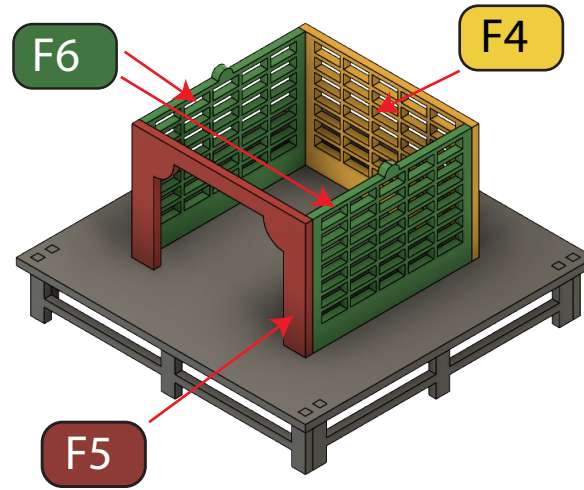

Step 13:

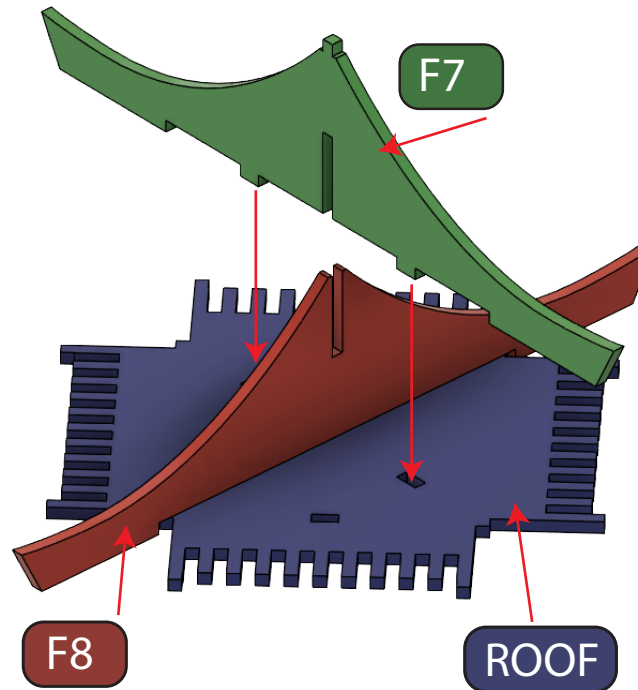

Step 14:

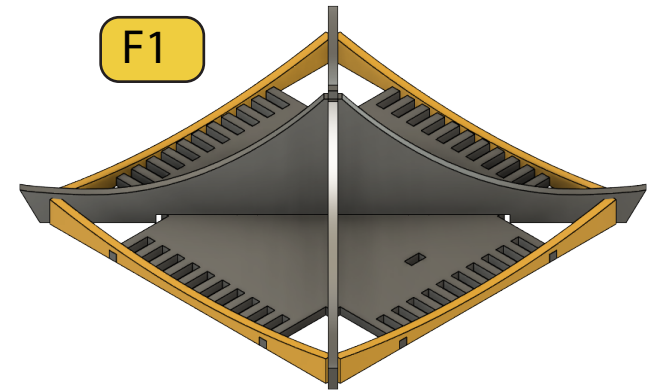

Step 15:

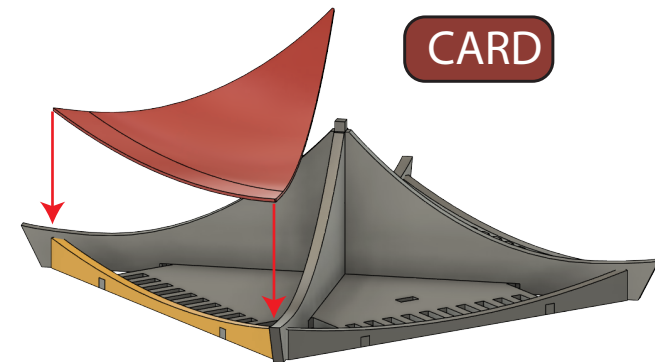



Step 16:

