

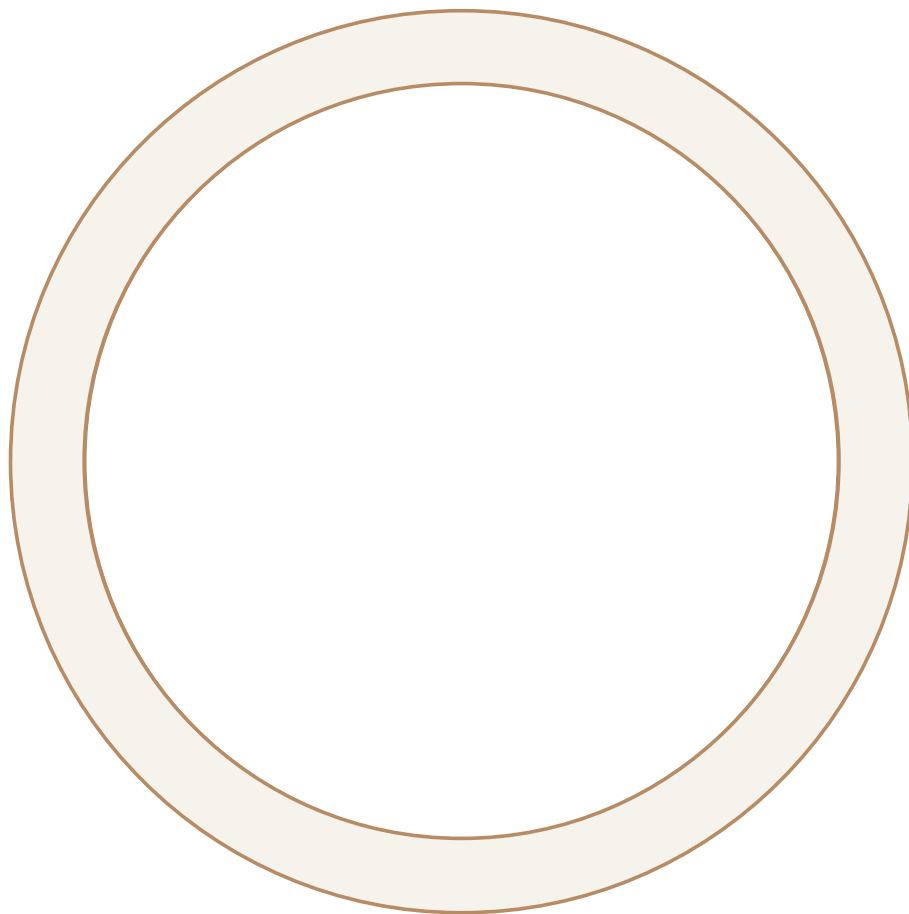

SO SCONCE (IP20)

Installation guide



LOW VOLTAGE - Do not wire light fitting directly to mains power.

SO SCONCE

Installation guide



DANGER electric shock risk. Installation must be conducted by a licensed electrician.

STAGE 1: INSTALL DRIVER

TCI Mini Jolly 125400

550mA Constant Current

Minimum cut-out hole diameter: 55 mm

Size: 111 x 22 x 52 mm

Plastic case: IP20 rated

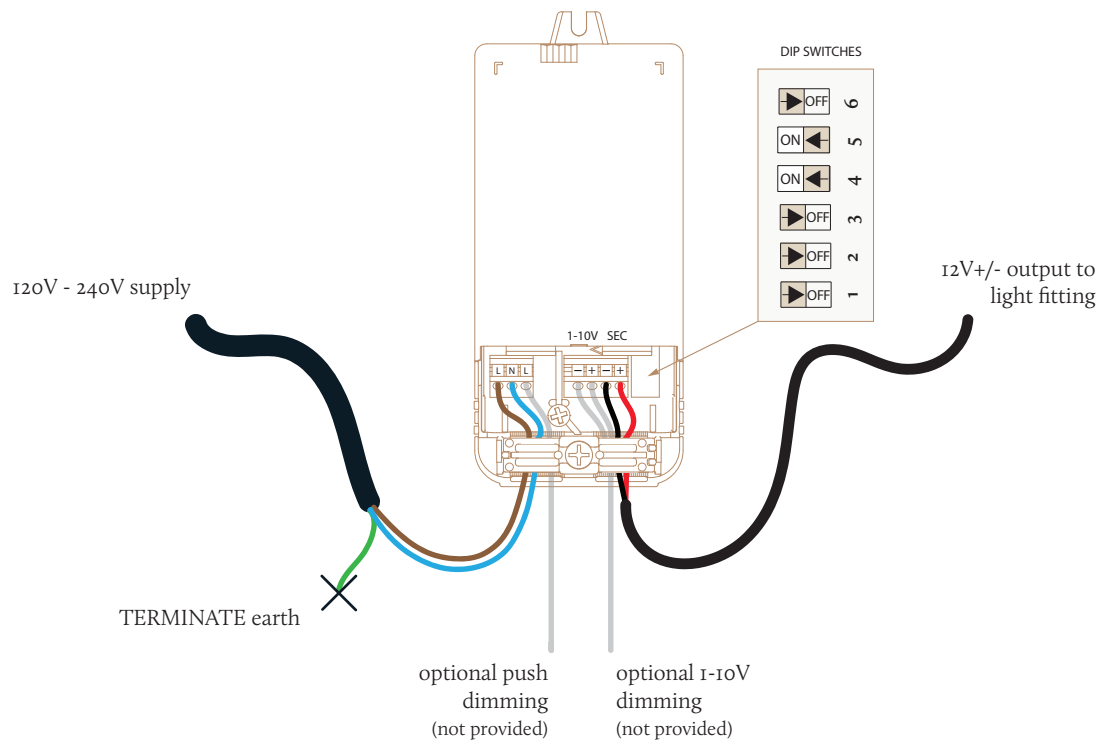

- 1: Select driver location, ideally a remote location that is accessible such as an attic or cupboard. Affix driver to solid surface.
- 2: Unscrew terminal cover and unclick from sides.
- 3: Check DIP switches are set to required position - if not, set to pattern as shown above using a small screwdriver.
- 4: Ensure mains supply is switched off. Connect 120V-240V Load and Neutral supply to the left side of the driver as shown.
- 5: Terminate earth if present.
- 6: *Option A:* While at the framing stage, run a 2x core cable from the SEC output on the driver, to the desired position of the luminaire.
Option B: If the driver must be located behind the luminaire. Connect +/- from LED luminaire to right side of driver in the SEC output.
- 7: (*Optional, not supplied*) If dimming is required, connect leads for 1-10V or Push Dimmer as illustrated.
- 8: Reattach terminal cover and screw closed.

STAGE 2: INSTALL FITTING



Ensure gloves are worn when handling natural brass products.



LOW VOLTAGE - Do not wire light fitting directly to mains power.

STEP 1:

- Remove all items from box.
- Install driver as shown on opposite page.
- Unscrew glass from brass dome LED module and carefully place aside.
- Using HEX key provided, loosen M6 grub screw on LED module, detaching the bracket and the canopy.
- Drill Ø40mm - Ø75mm hole in the wall central to where you would like the fitting.

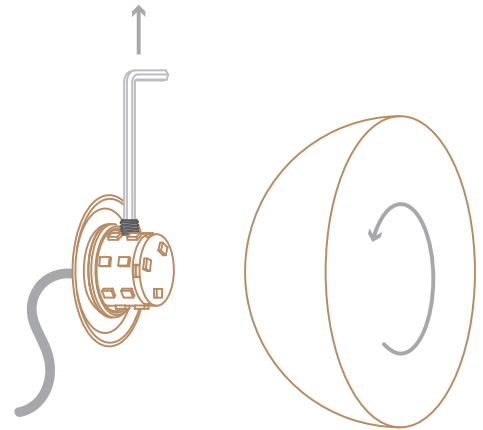

STEP 2:

- Keep the cable power supply threaded through the canopy and through the white wall bracket.
- Have someone else hold the LED module and the brass canopy.
- (Alternately place these items on a stool or something of a similar height.)
- Pass the cables of the luminaire and the driver through the window in the wall bracket and hang to the side.
- Install bracket to wall using timber screws provided.

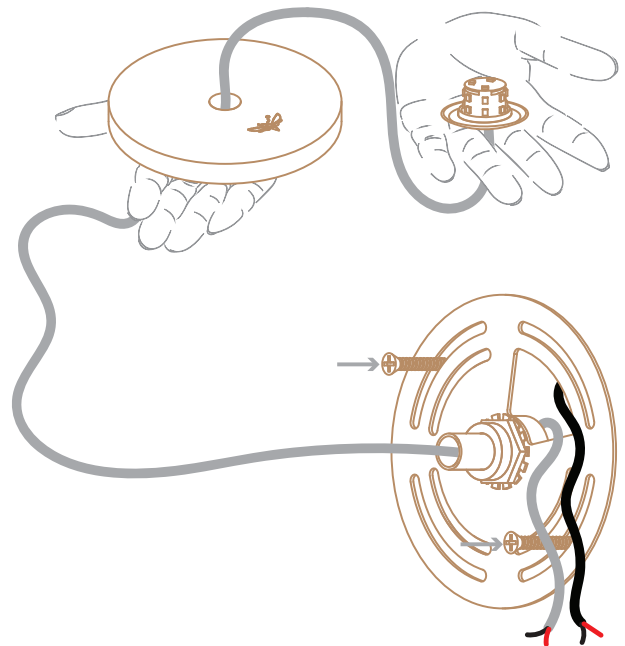

STEP 3:

- Trim cable as necessary.
- Connect +/- power supply from LED luminaire to TCI Mini Jolly driver using wago connectors.
- Pass the surplus cable and wago connectors into the wall cavity.

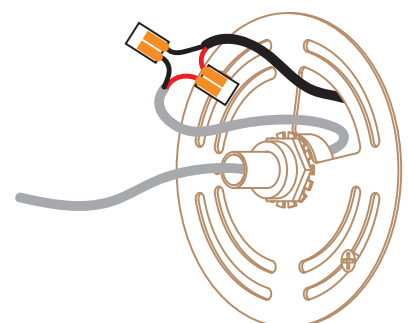

STAGE 2: INSTALL FITTING CONTINUED

STEP 4:

- Carefully place the brass canopy and LED module onto the brass stem on the wall bracket.
- **Ensure pressure is applied to canopy and it is correctly centered.**
- Moth logo is to be aligned at the bottom of the fixing.
- Tighten M6 grub screw to fix the LED module in place.
- Check fitting is secure before proceeding.

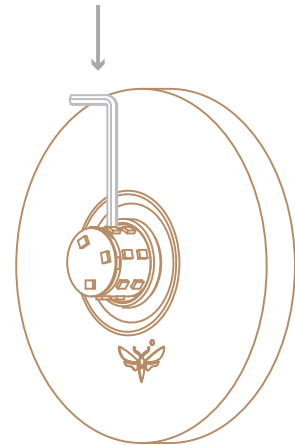

STEP 5:

- Carefully screw glass diffuser onto module.

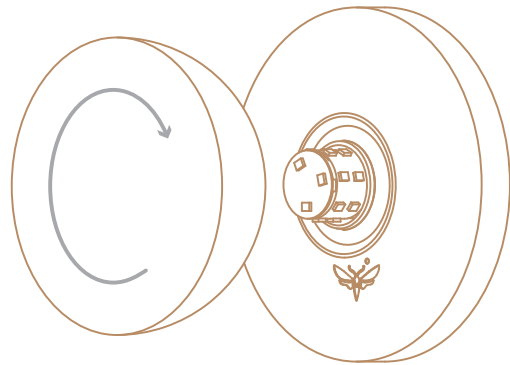

STEP 6:

- Wipe down fitting with supplied dry cloth.
- Test fitting.

