

# LETTERCUT

## CAPITAL LETTER TEMPLATE 8 inch Classic Modern

### INSTRUCTIONS:

1. Print template pages at full size for accuracy.
2. Assemble template.
3. Tape the template in place.  
Use a level to ensure your template is straight.
4. Predrill the screw holes - using house numbers as a guide.
5. Fasten with screws through the number and spacer.

#### **Lining your letters up:**

Solid lines on the top and sides of page mark the centers of the letters so you can easily align your letters vertically or horizontally. When you assemble your template - tape pages together so solid lines line up.

*Heights vary slightly - Numbers and letters are all designed for visual appeal. A slight variation in number height and width is intentional.*

#### **Spacing your letters :**

These dotted lines create even spacing of letters  
Fold template on the dotted line and tape papers together so dotted lines match.  
\*Easily add or subtract space by adding or decreasing space between dotted lines.

Suggested spacing between 8" tall letters:  
For horizontal placement is 1.5 - 2" between letters.  
For vertical placement - allow 1.5 - 2.5" between letters.

# LETTERCUT

For letter - print page:

- A - page 3 + 4
- B - page 5
- C - page 6
- D - page 7
- E - page 8
- F - page 9
- G - page 10 + 11
- H - page 12
- I - page 13
- J - page 14
- K - page 15
- L - page 16
- M - page 17 + 18
- N - page 19
- O - pages 20 + 21
- P - page 22
- Q - page 23 + 24
- R - page 25
- S - page 26
- T - page 27
- U - page 28
- V - page 29 + 30
- W - page 31 + 32
- X - page 33
- Y - page 34
- Z - page 35

Send Jane an email: [Jane@MyLettercut.com](mailto:Jane@MyLettercut.com)  
if this template does not work for you

Letter A  
page 1 of 2  
center of letter is where the pages meet.  
Tape the pages together with no overlap

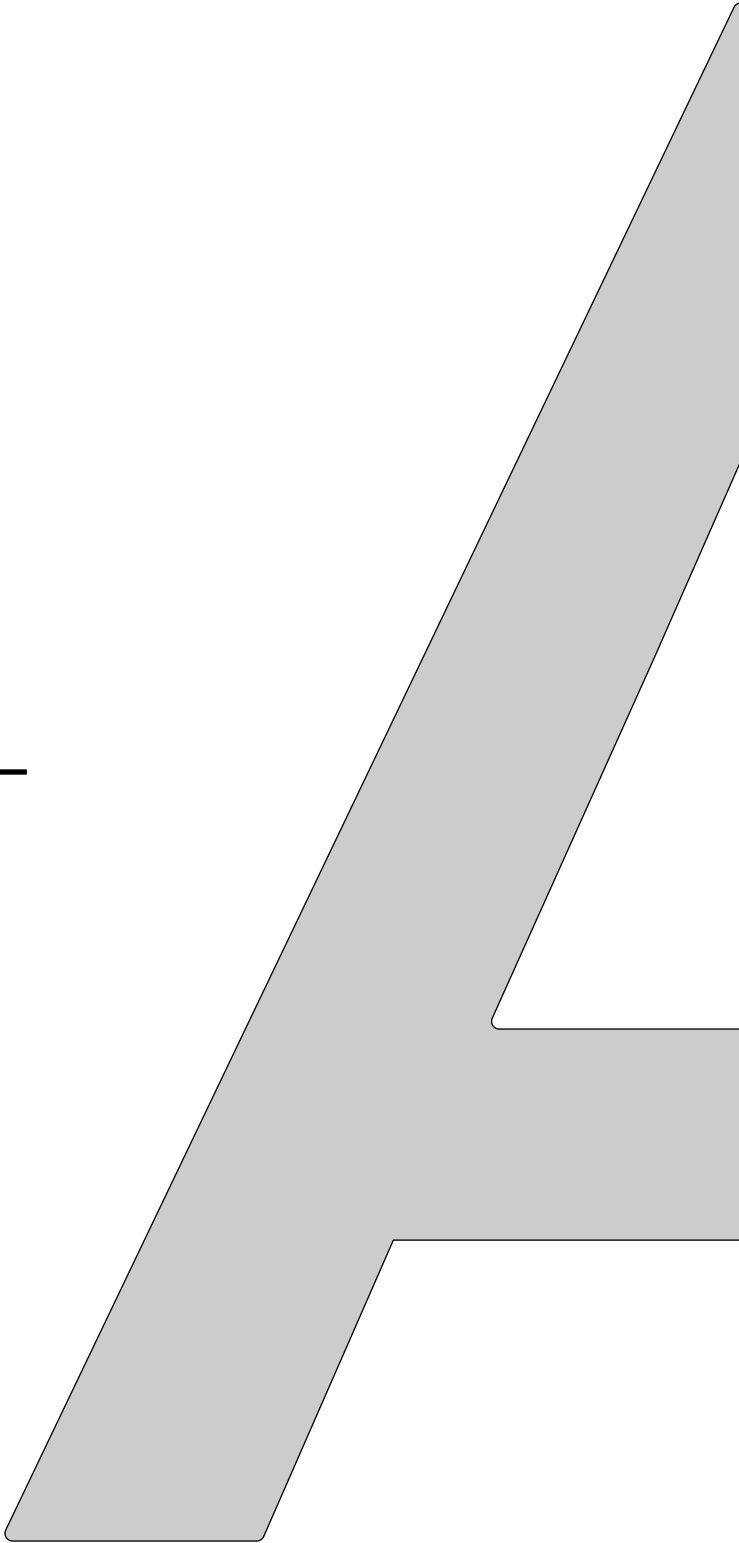

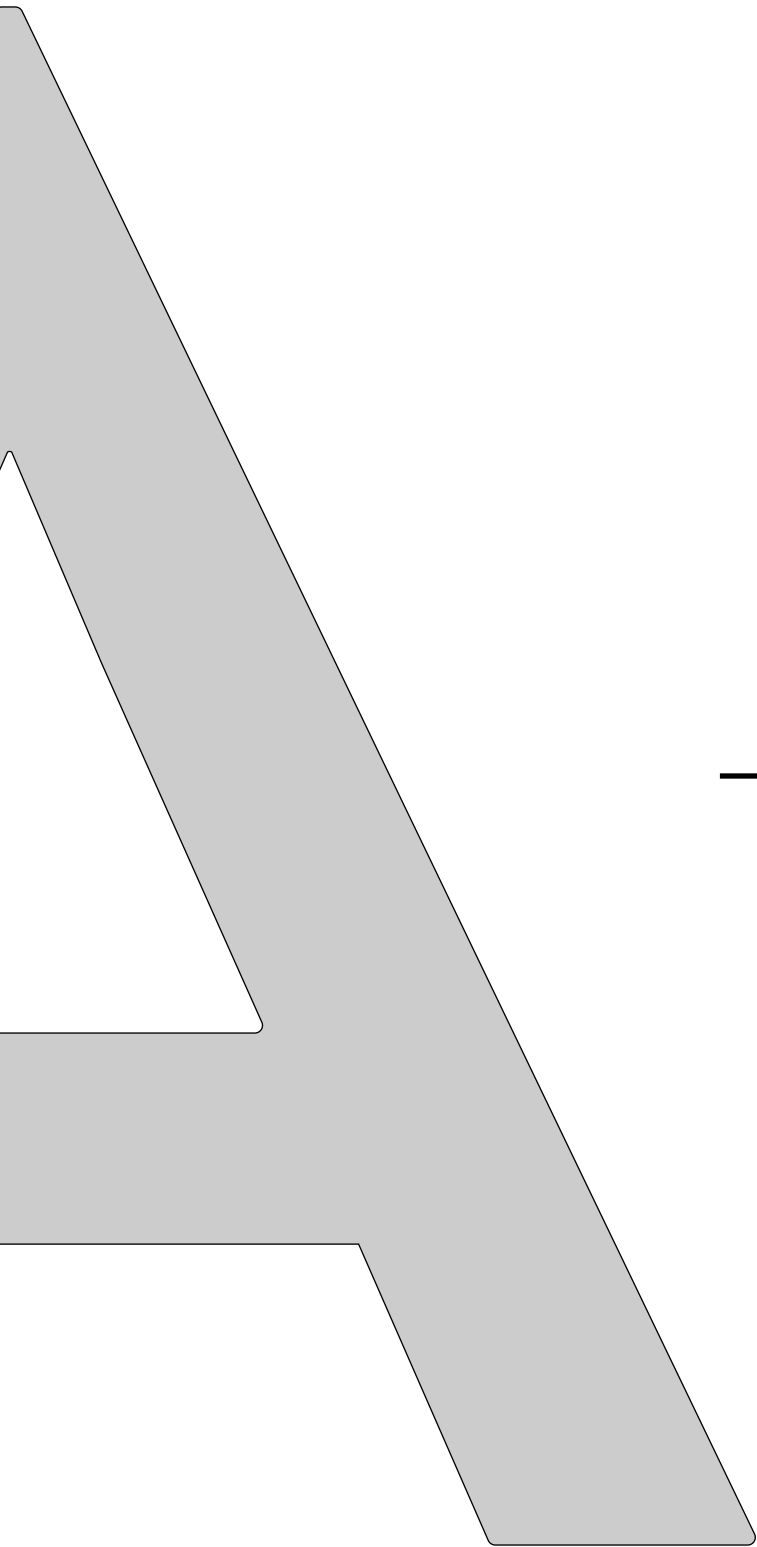

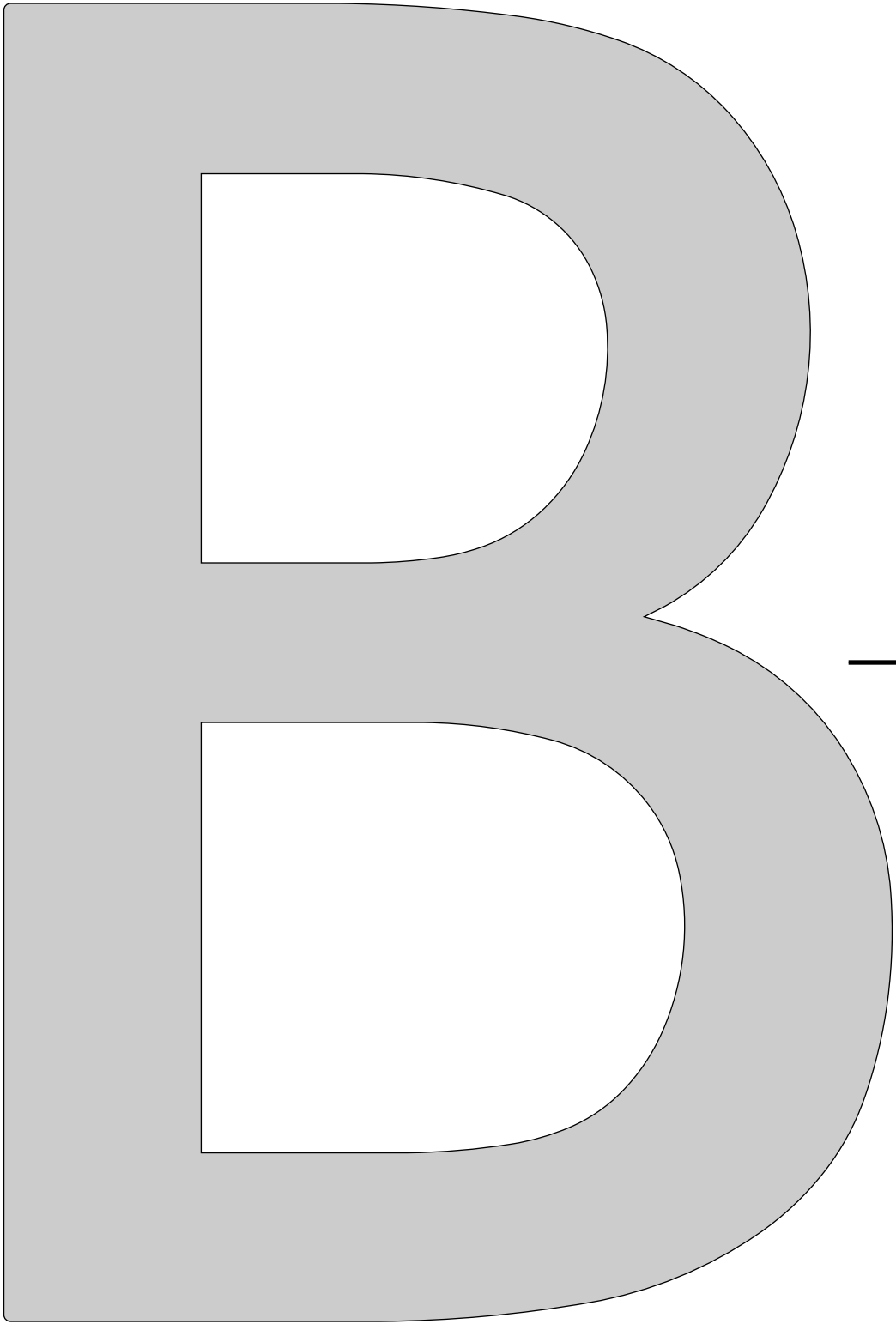

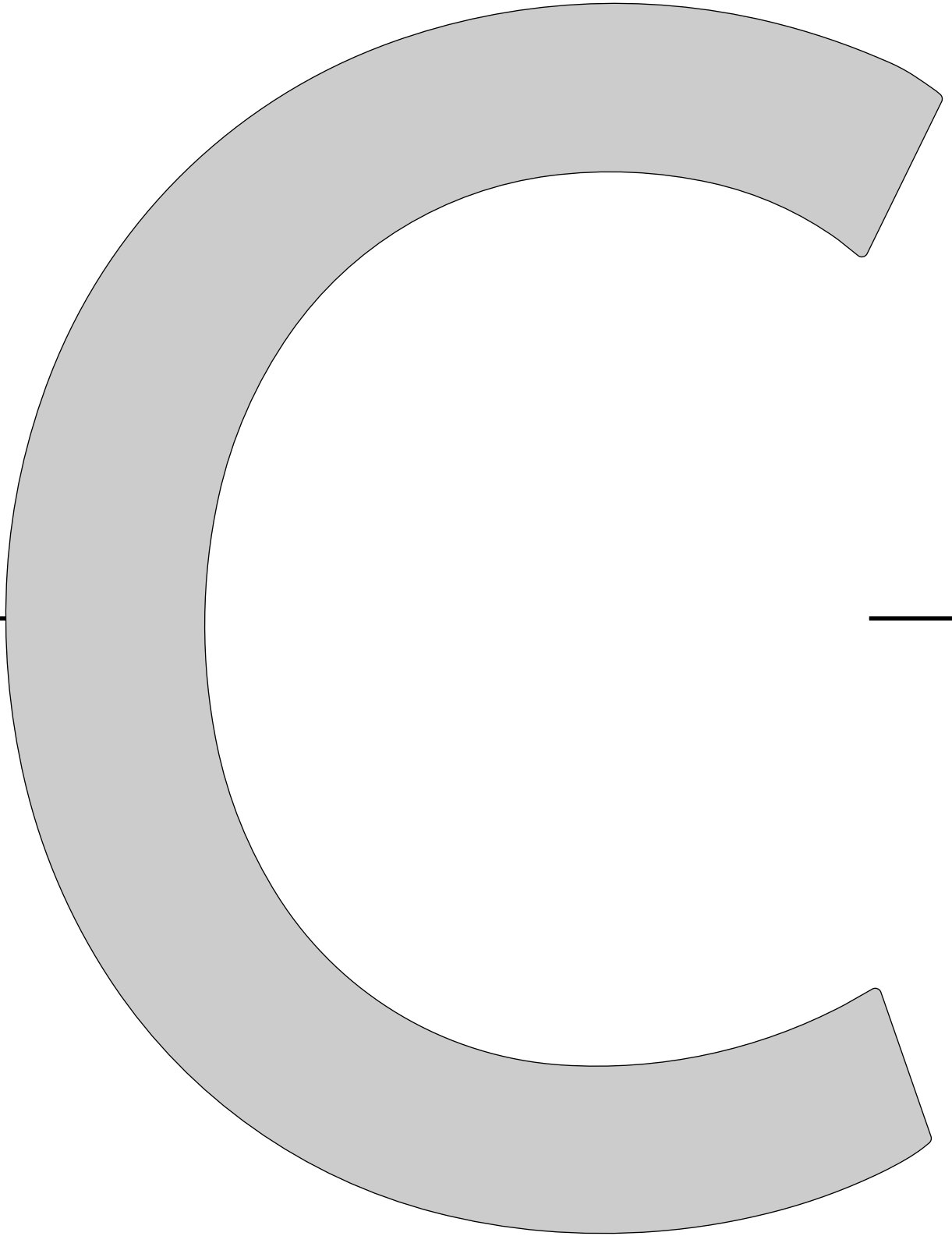

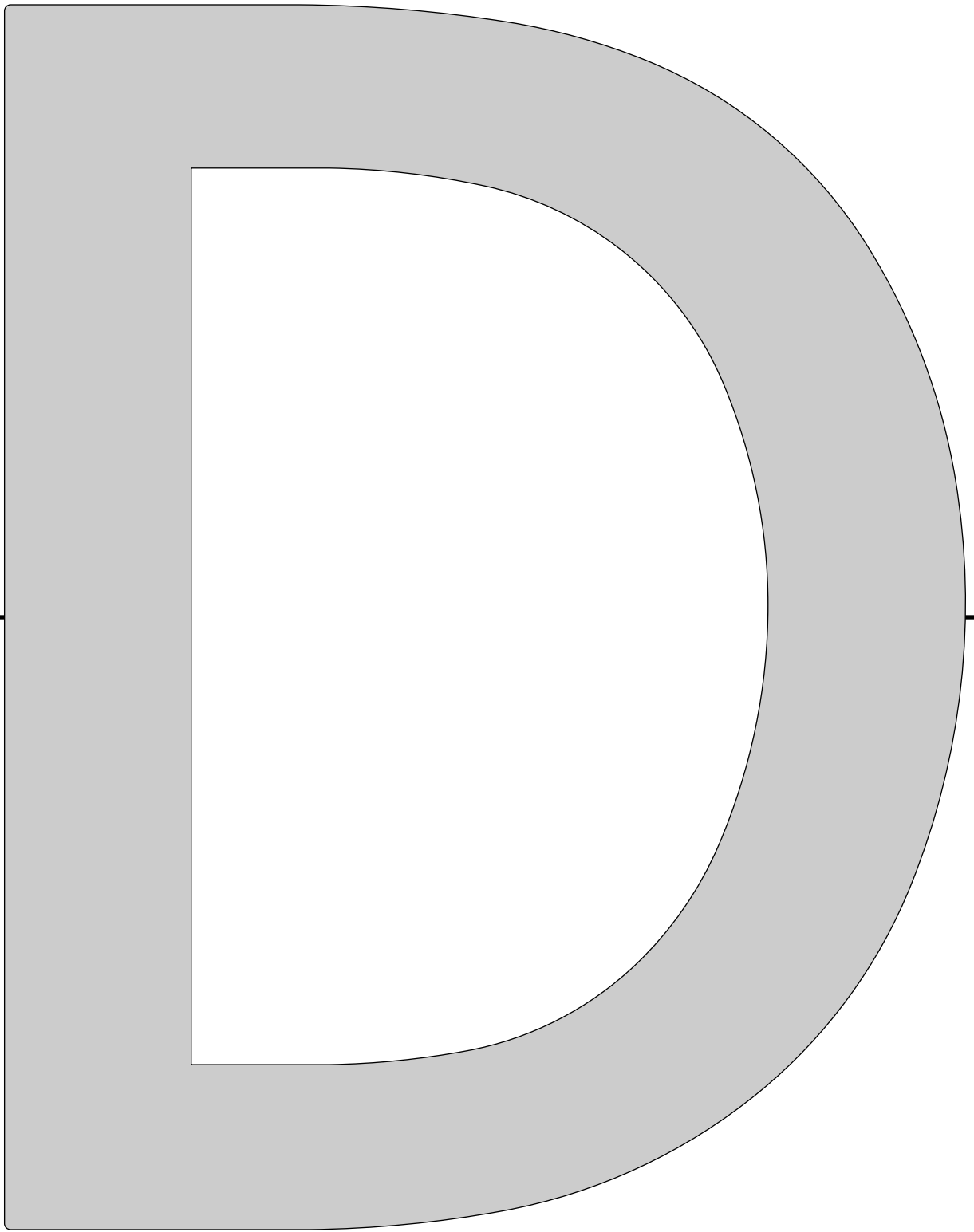

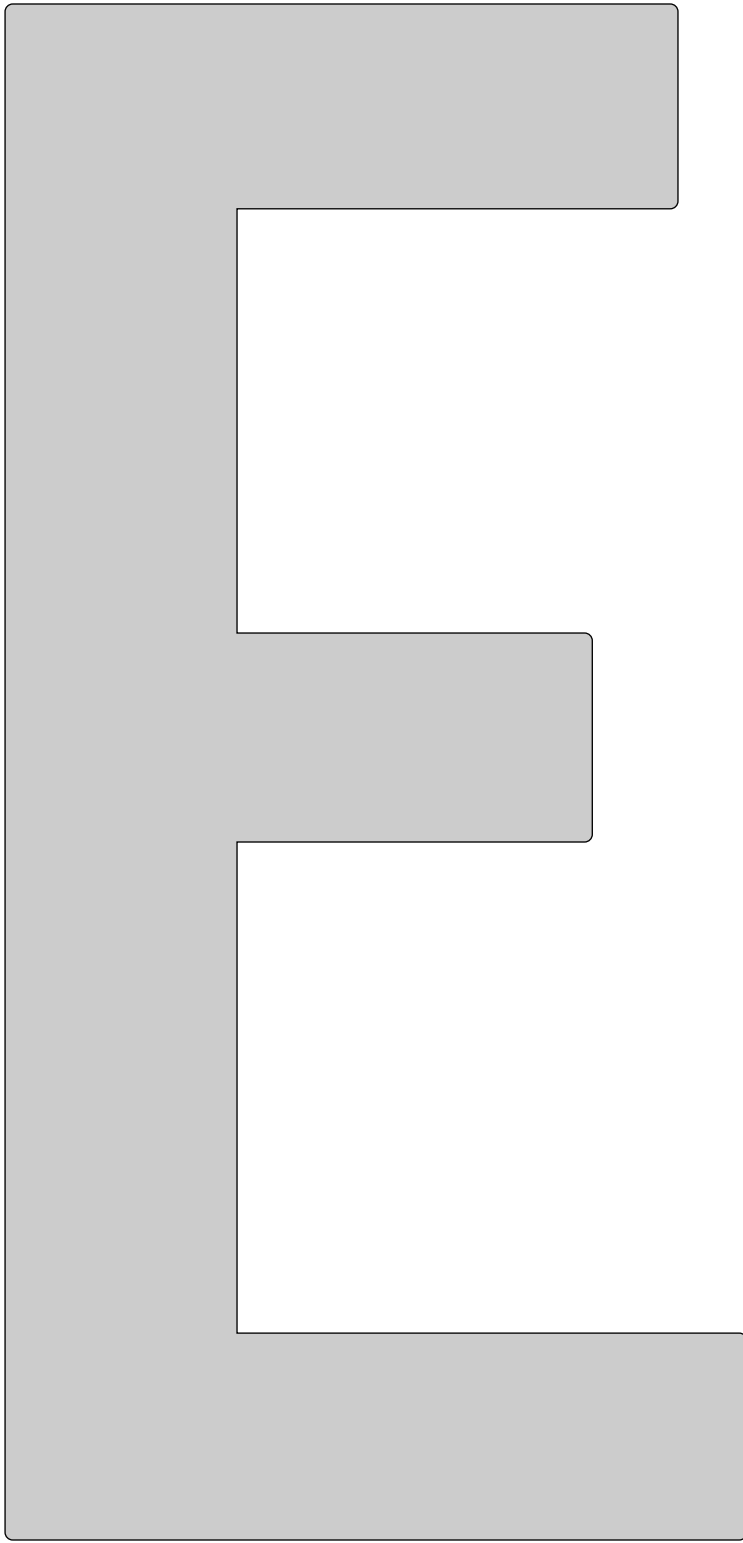



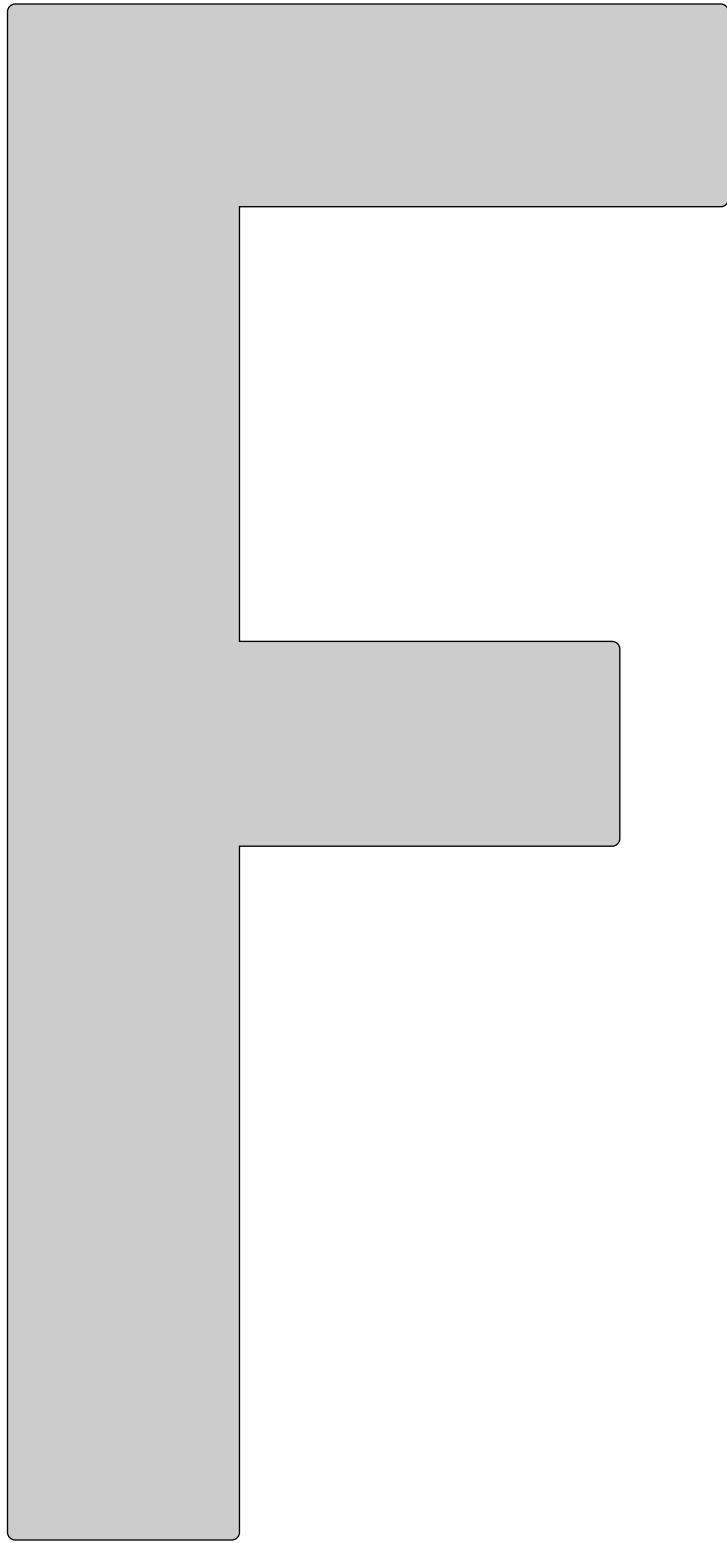

Letter G  
page 1 of 2  
center of letter is where the pages meet.  
Tape the pages together with no overlap

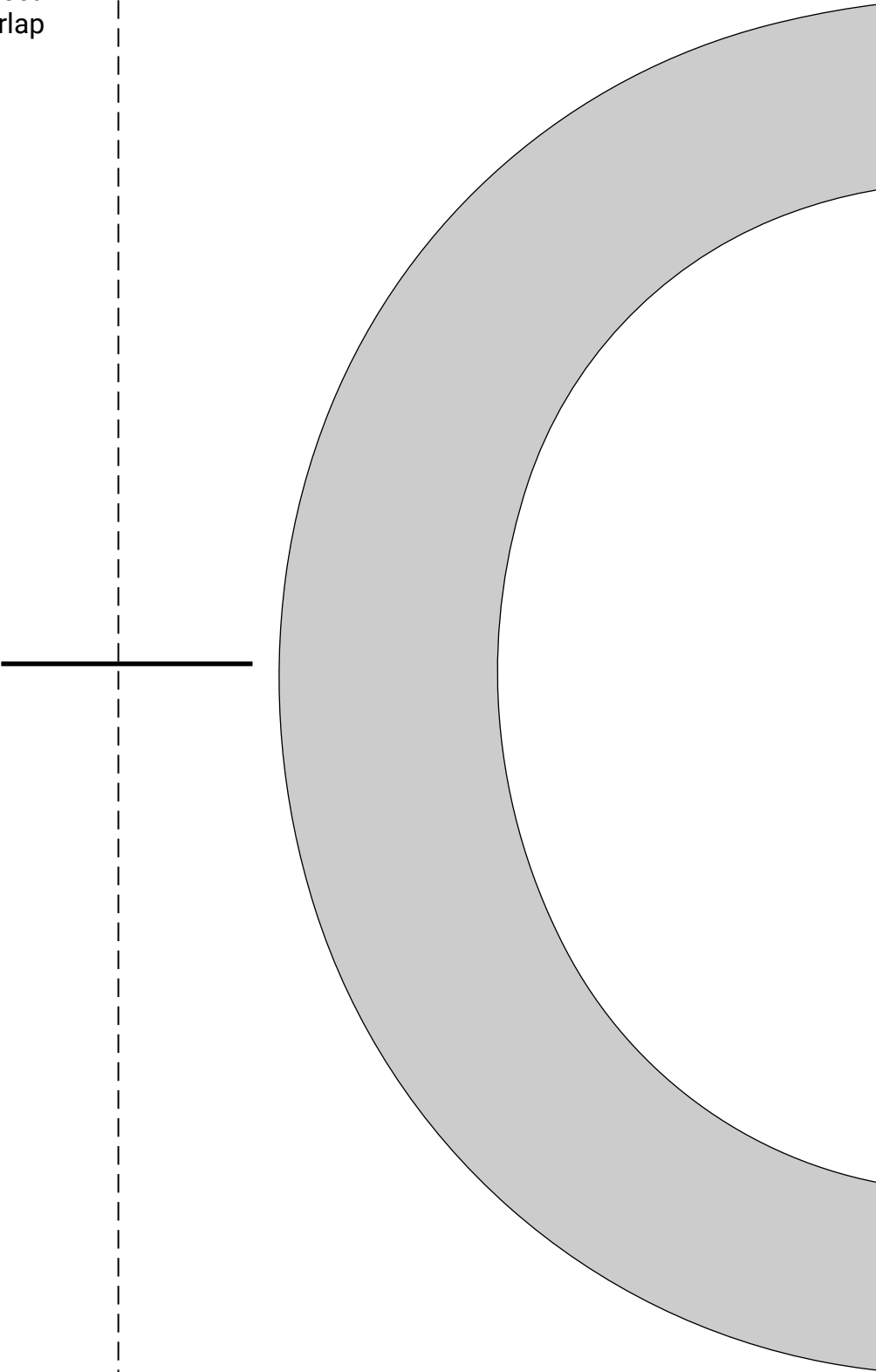

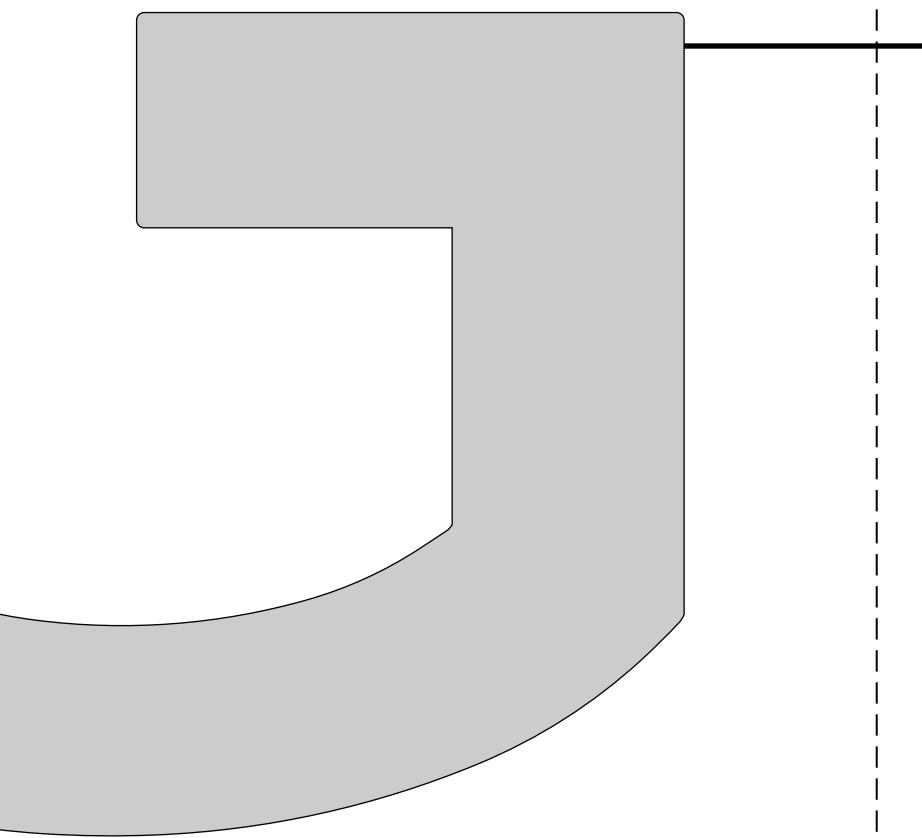
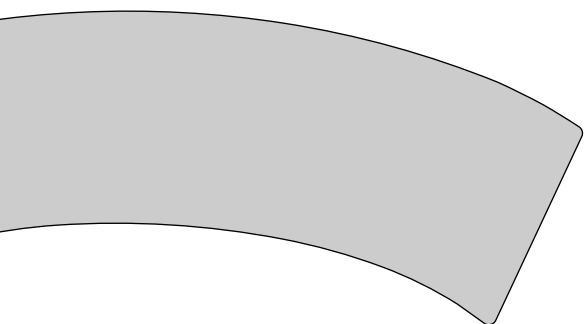

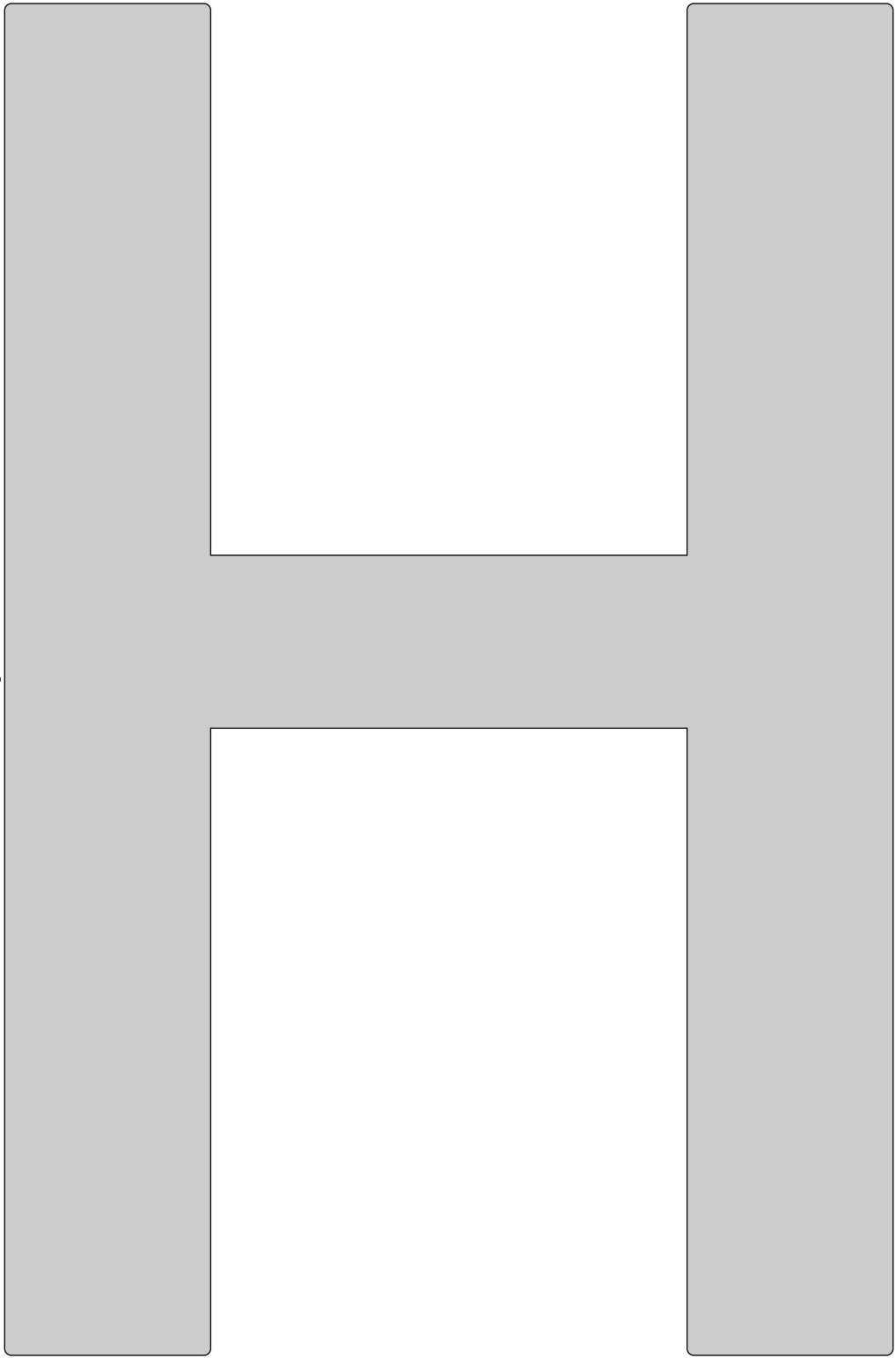

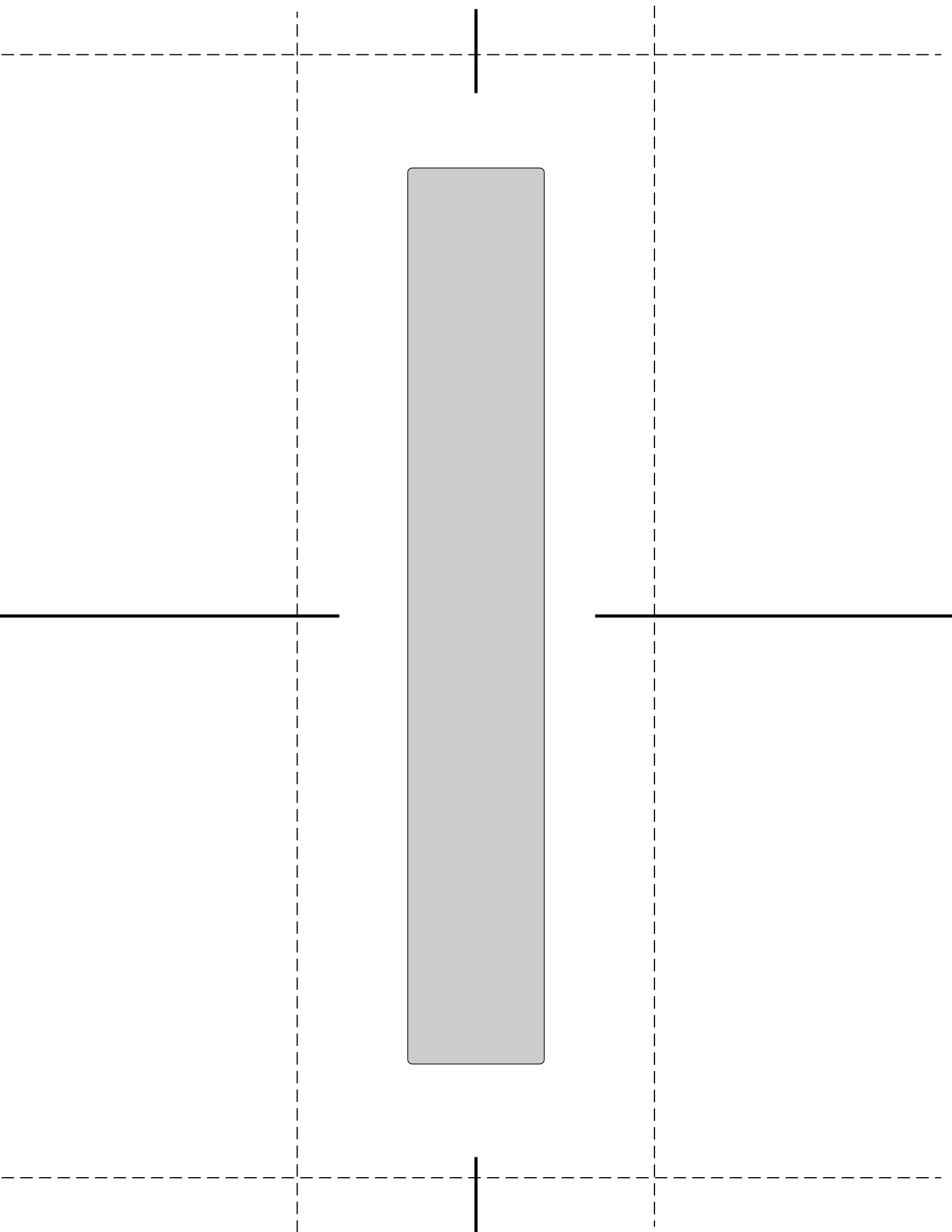

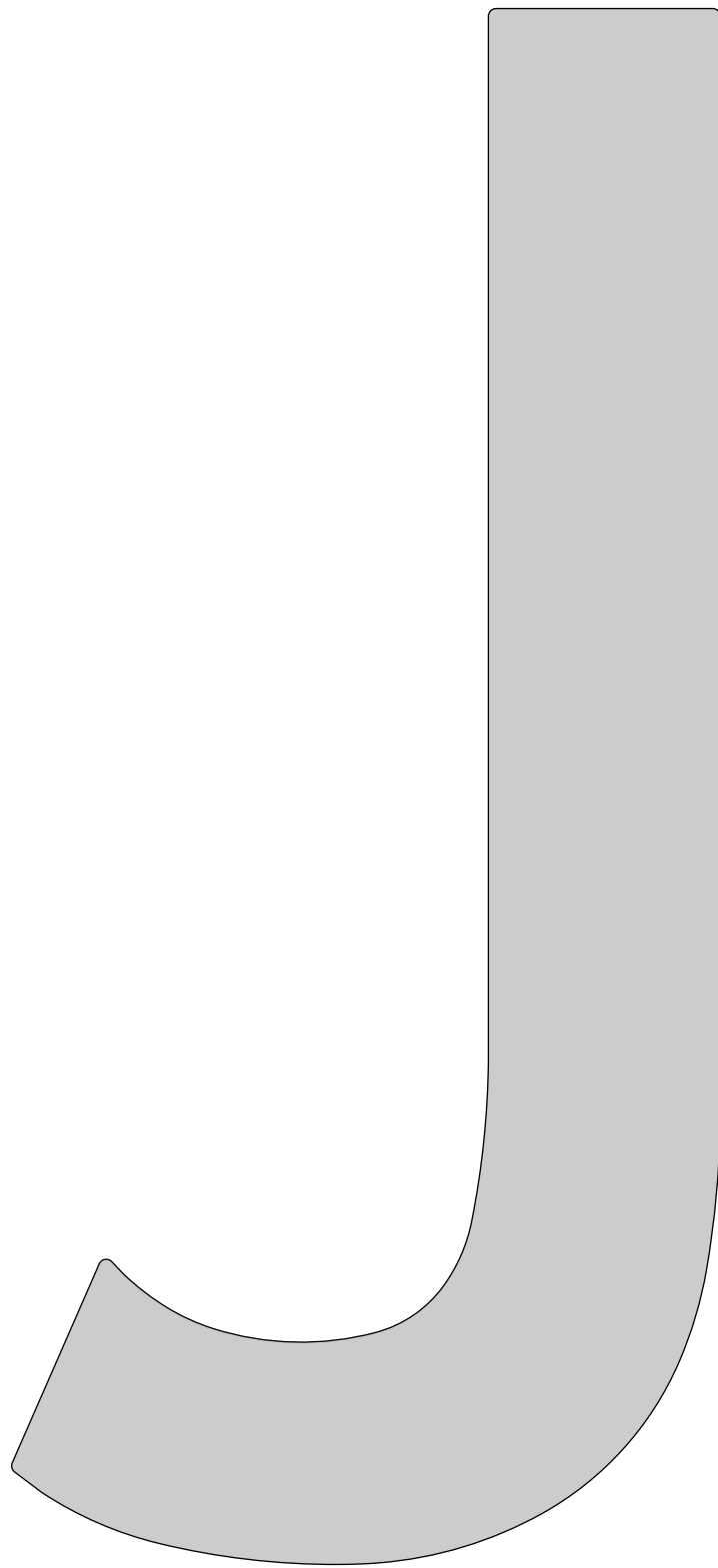

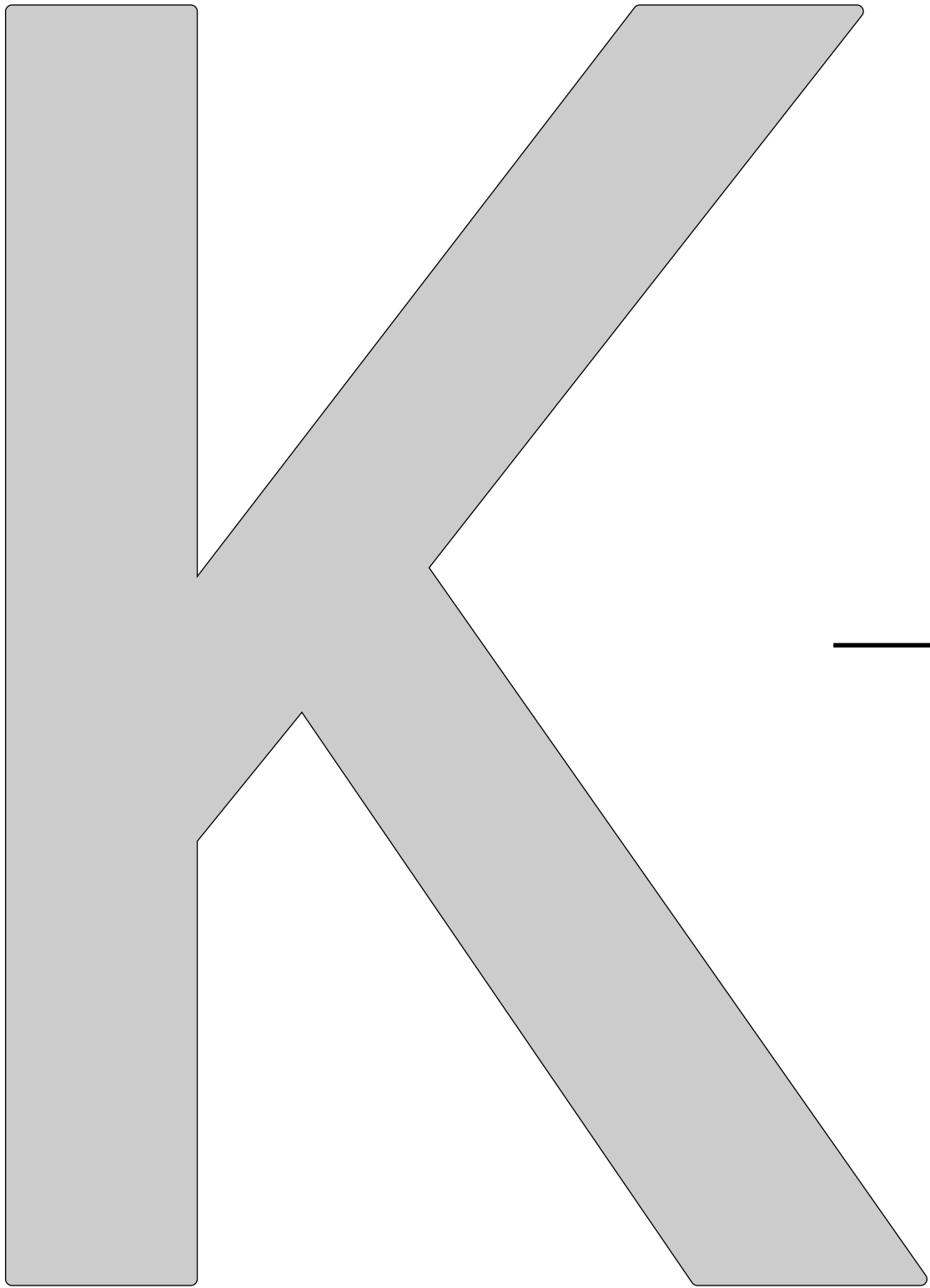

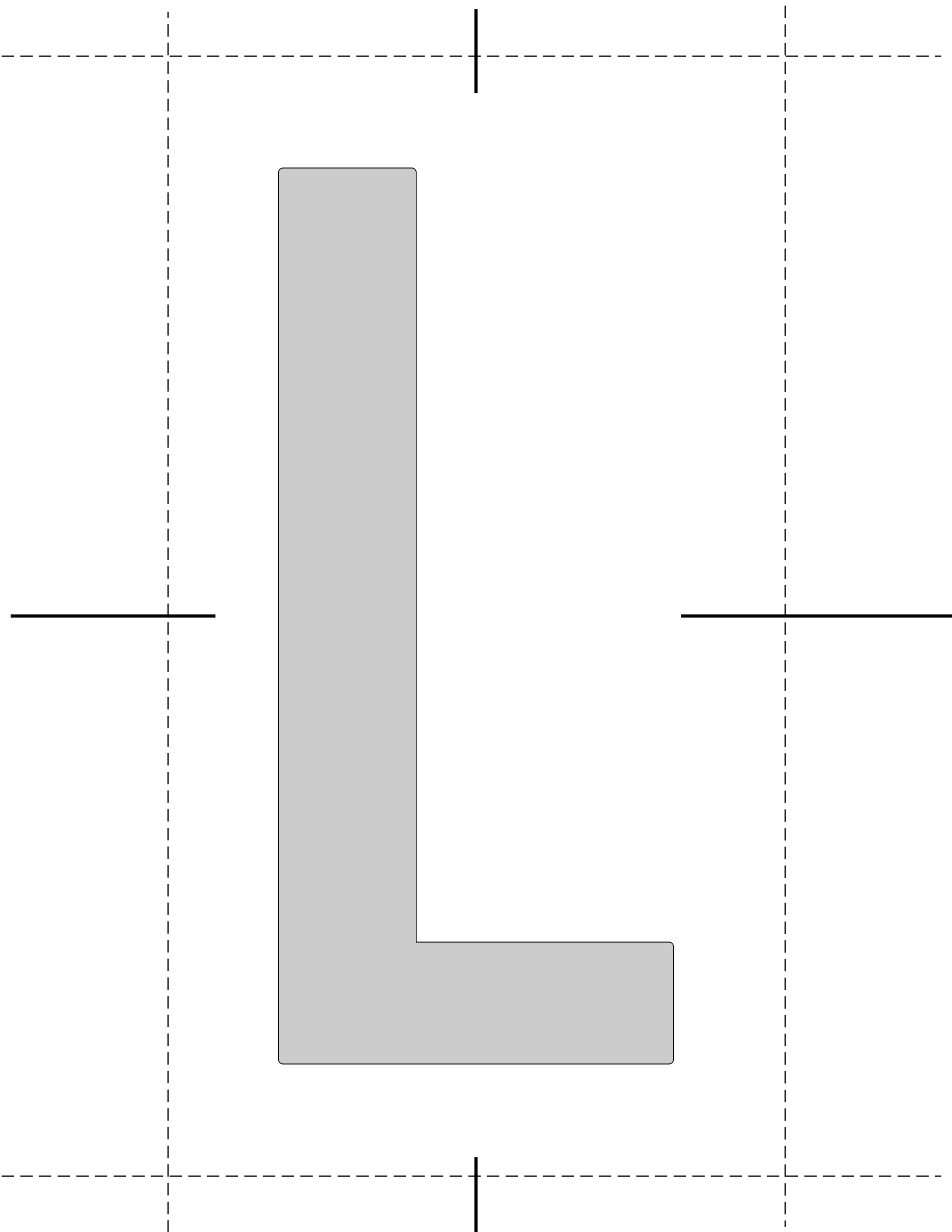



Letter M  
page 1 of 2  
center of letter is where the pages meet.  
Tape the pages together with no overlap





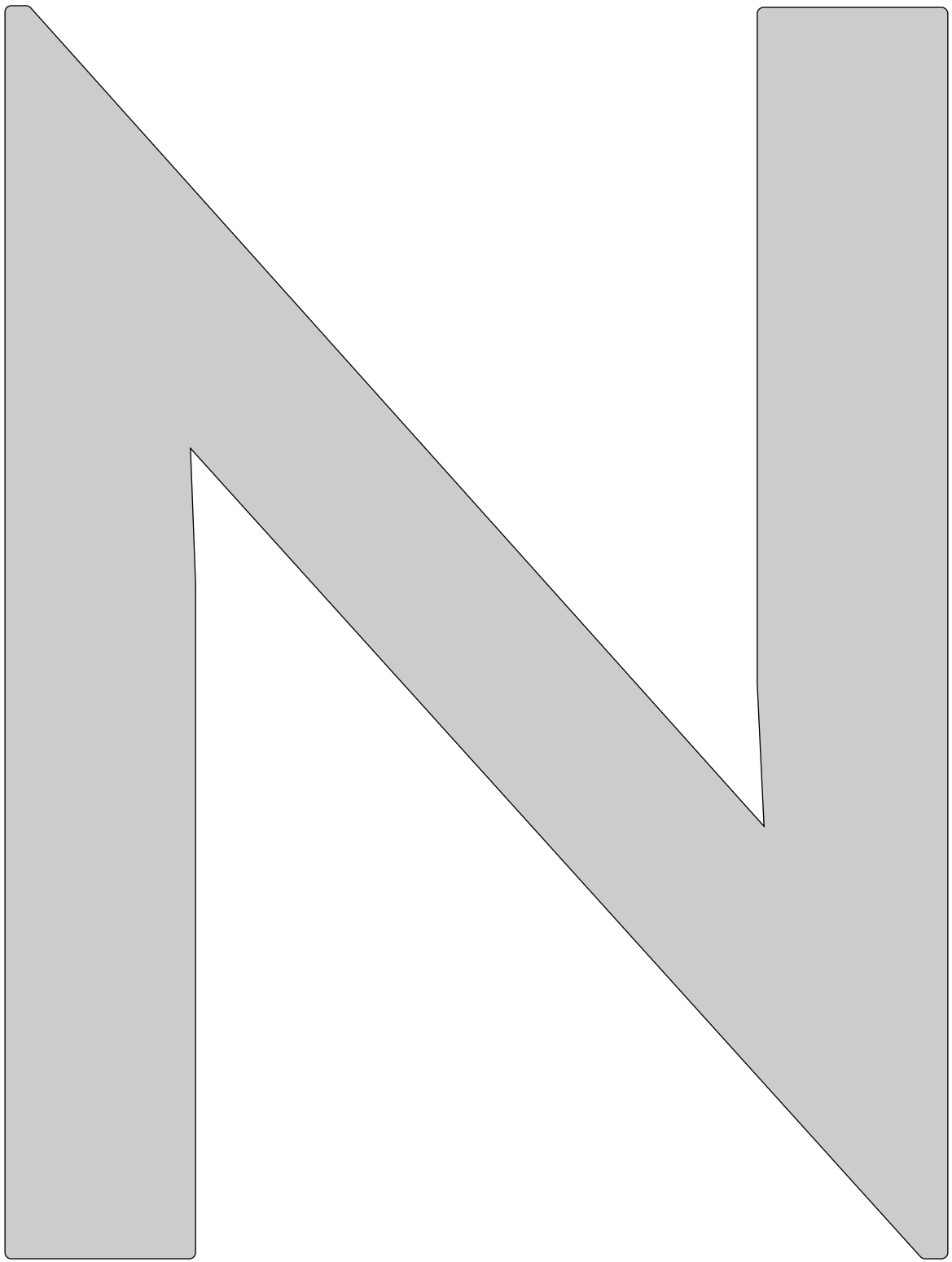

Letter O  
page 1 of 2  
center of letter is where the pages meet.  
Tape the pages together with no overlap

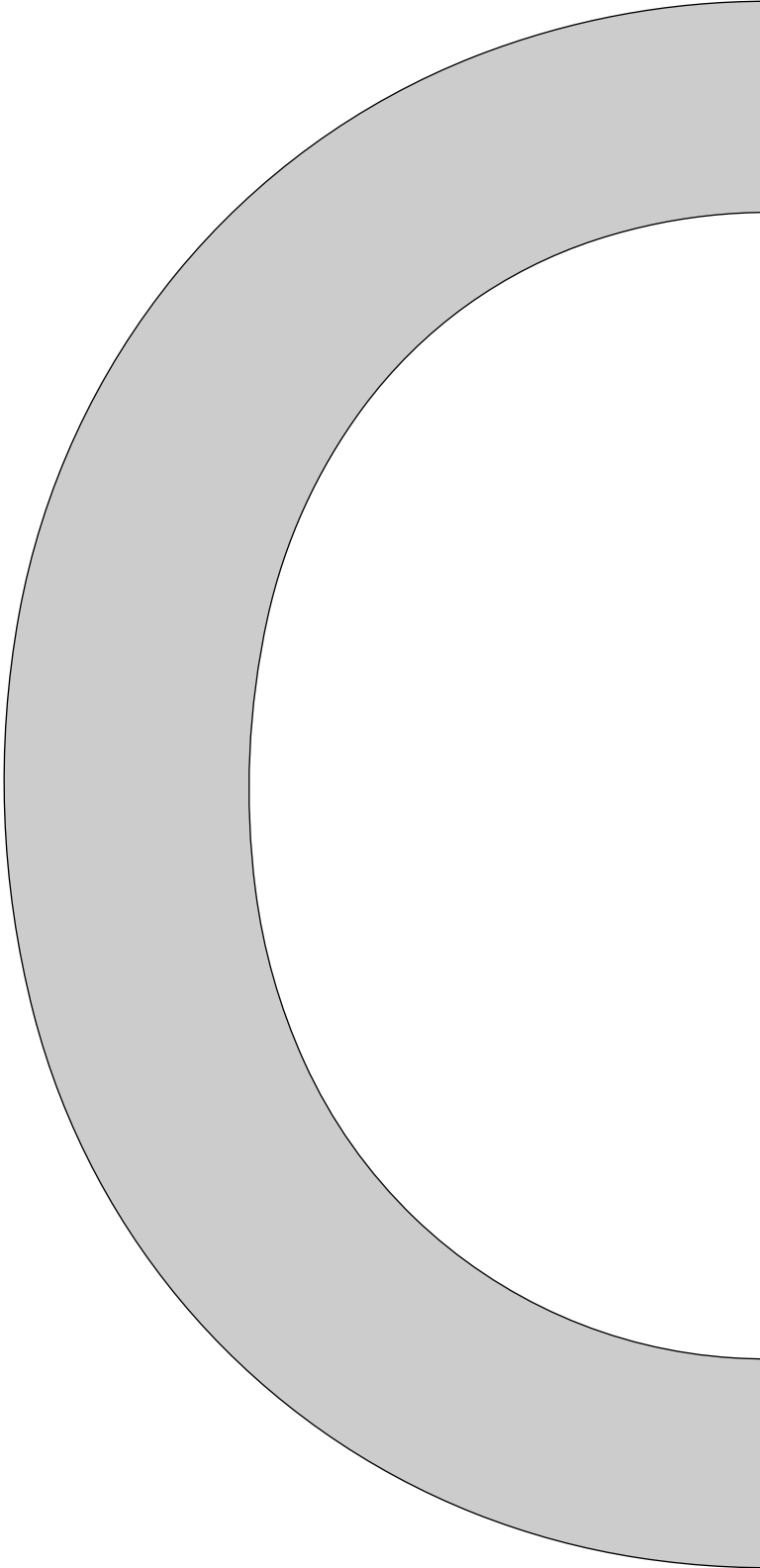

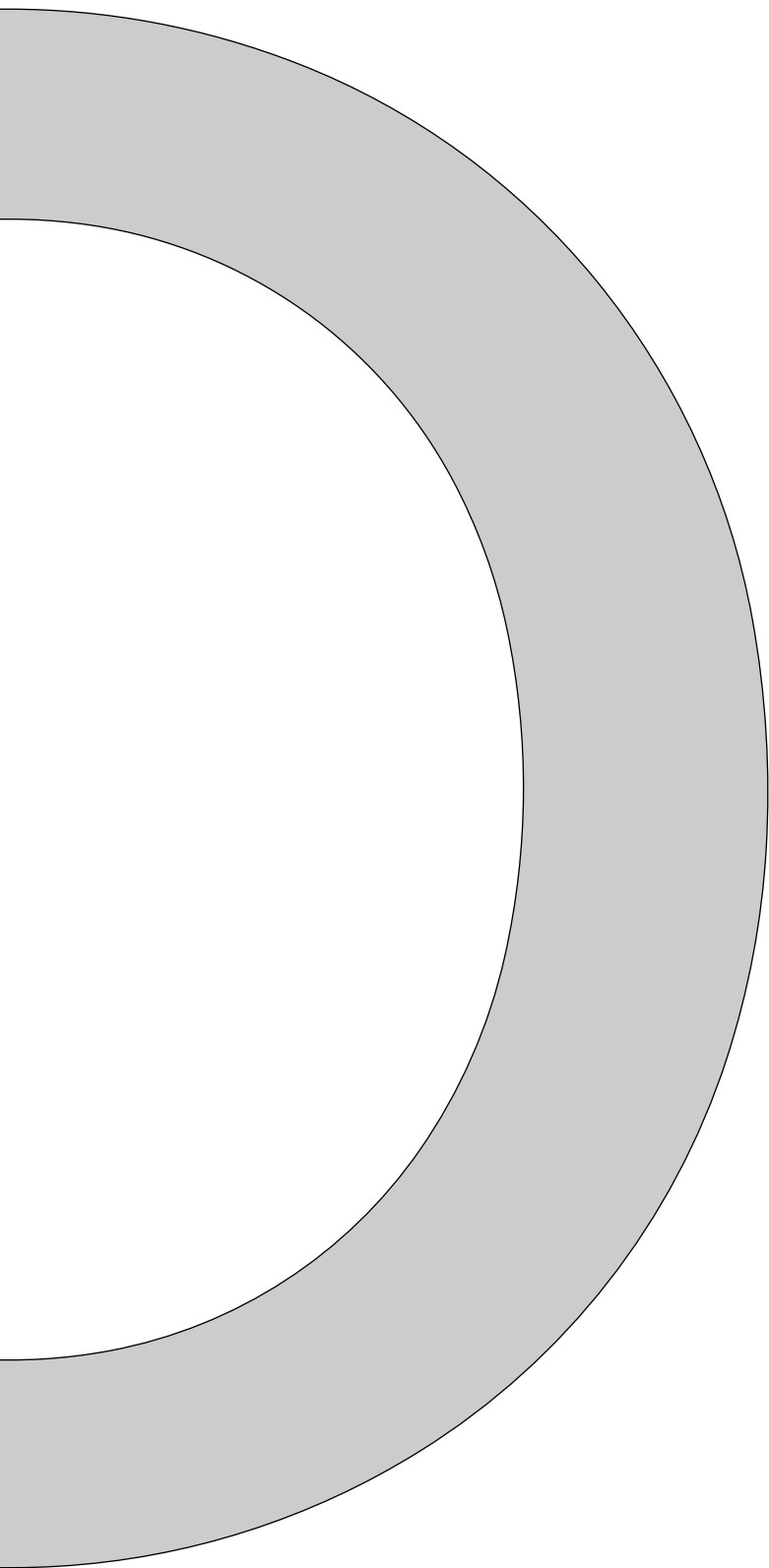

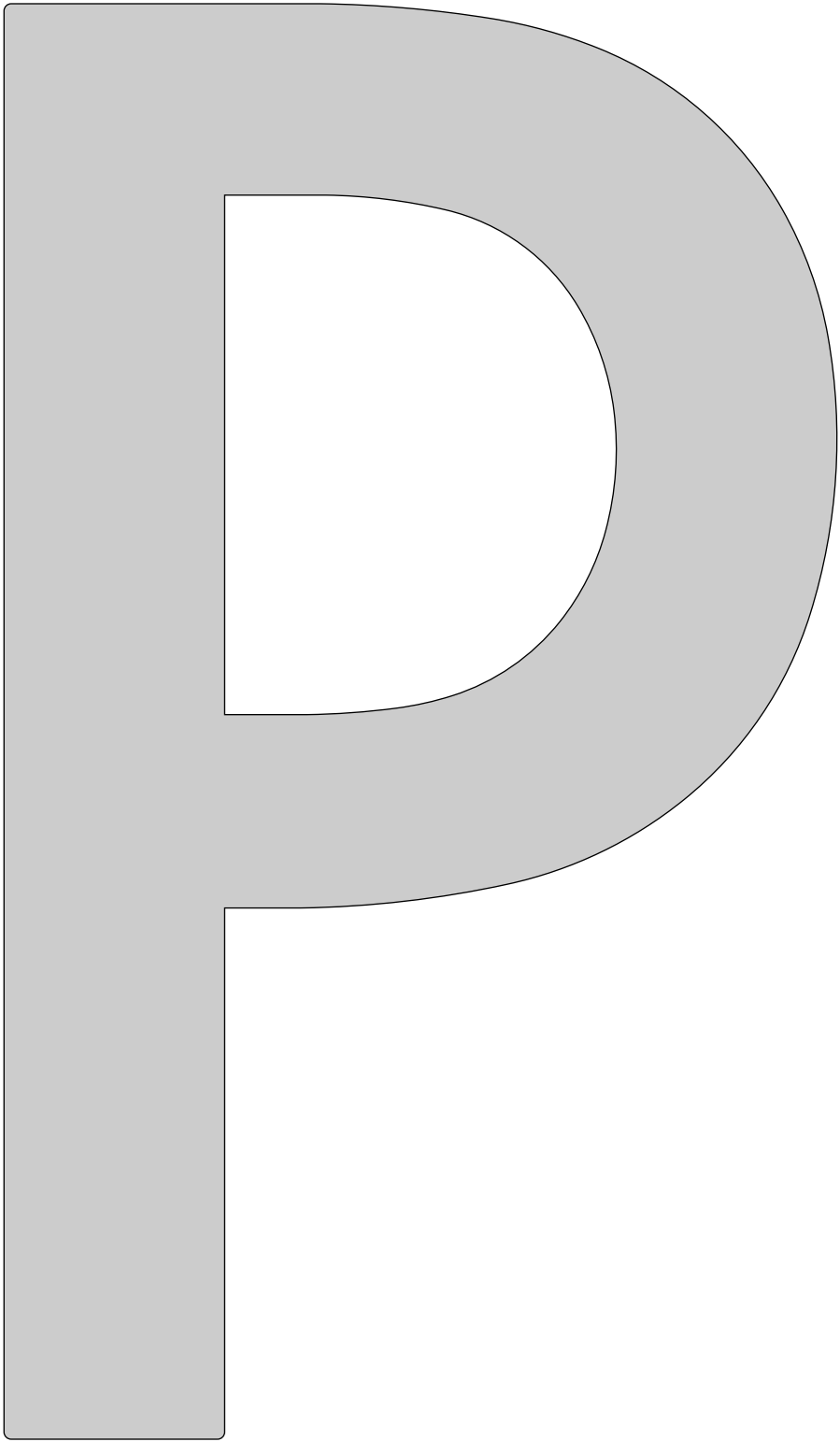

Letter Q  
page 1 of 2  
center of letter is where the pages meet.  
Tape the pages together with no overlap

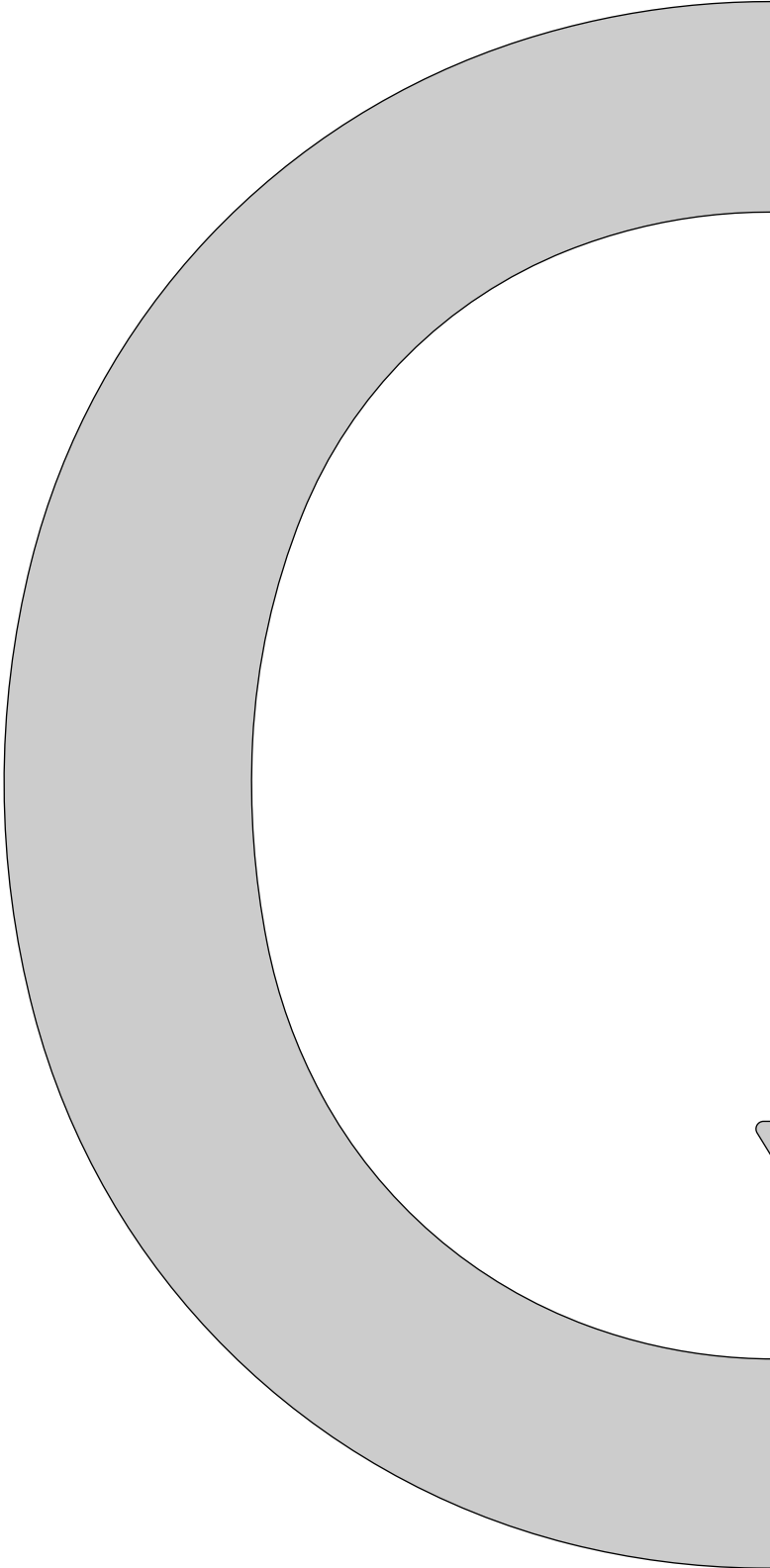

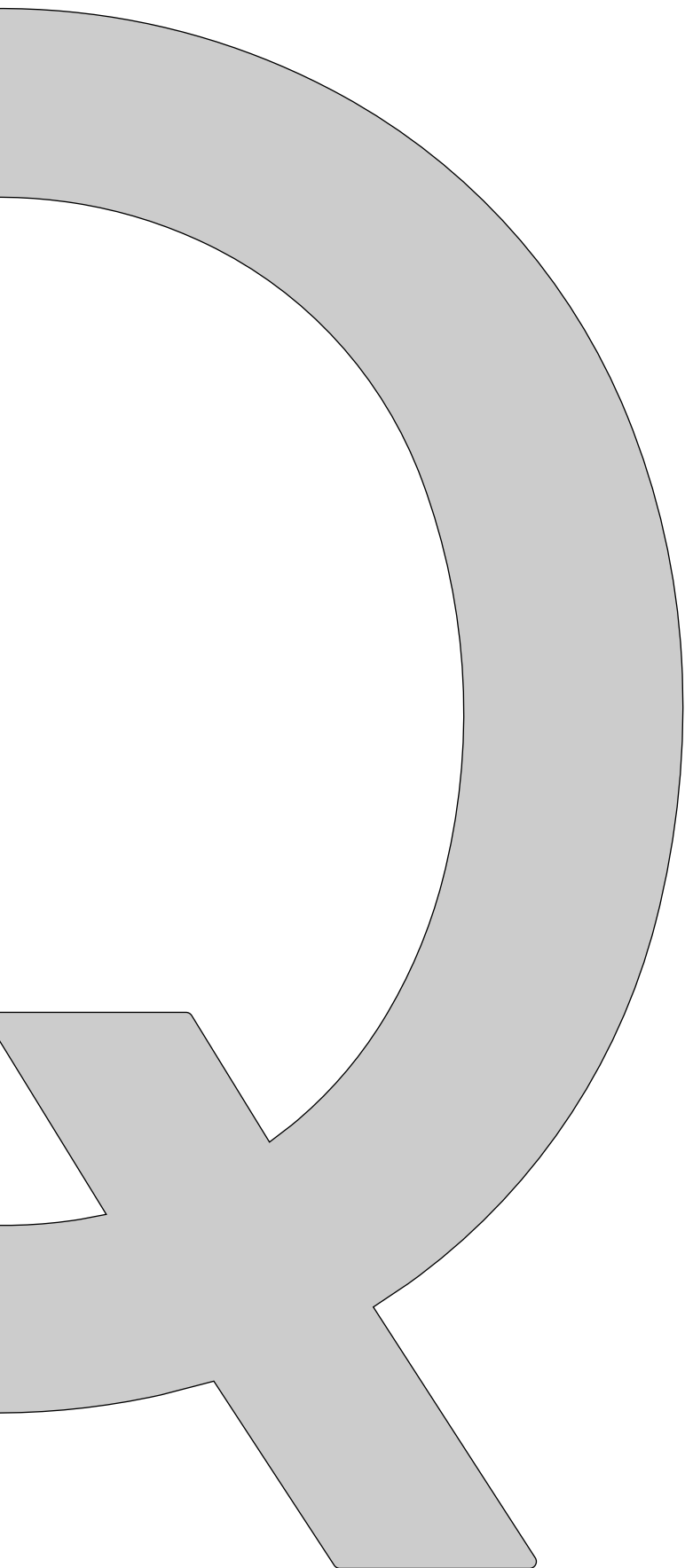



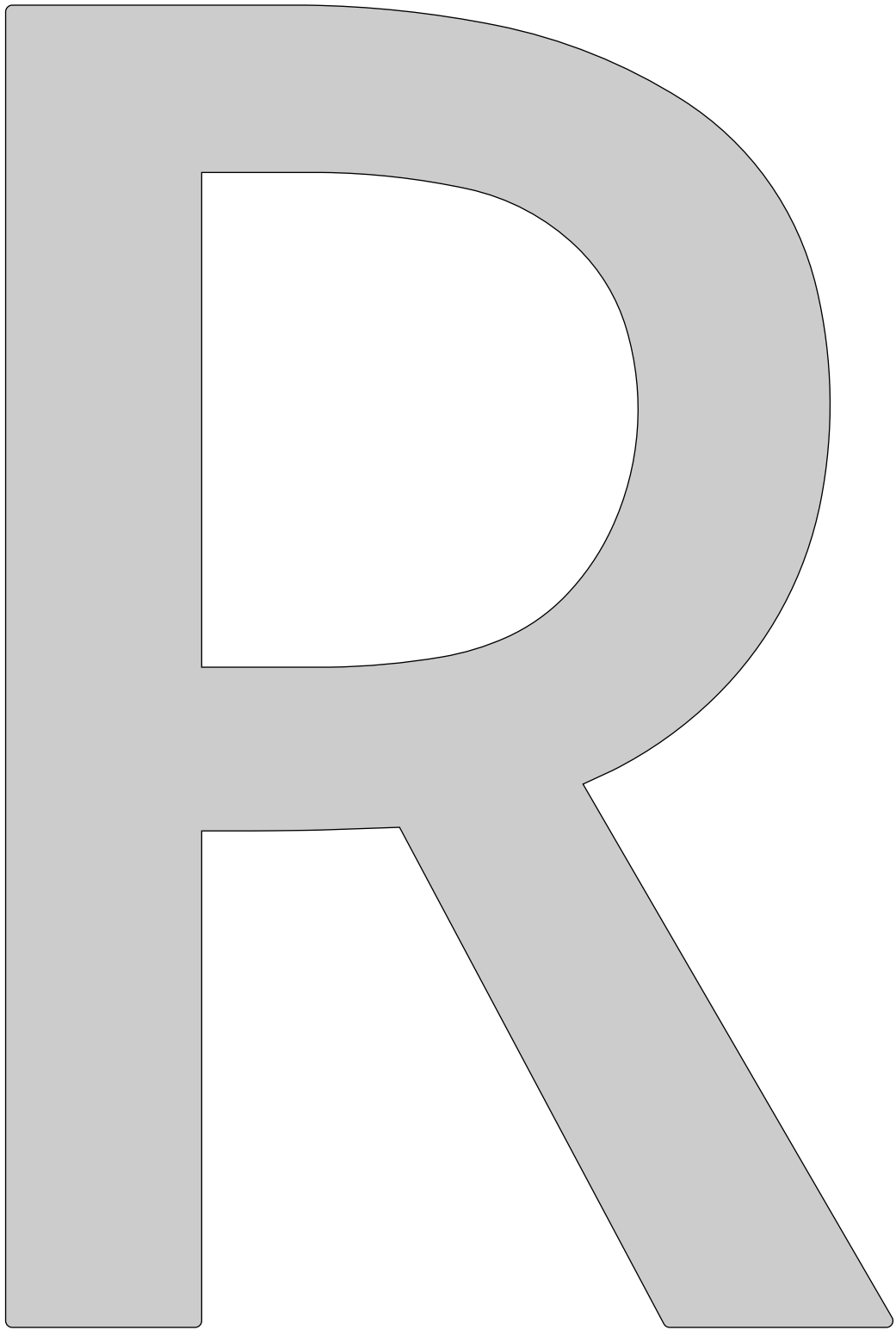

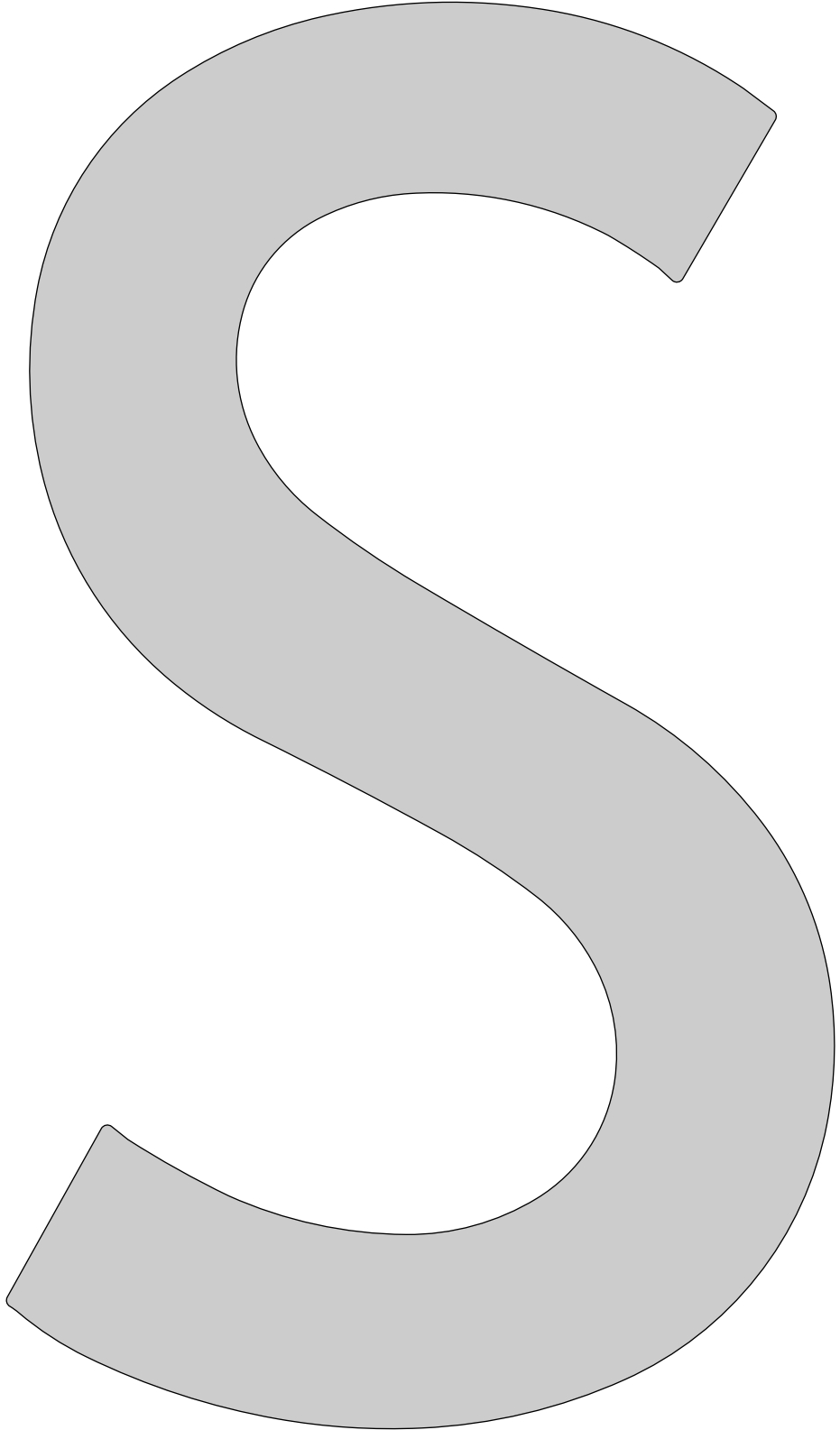

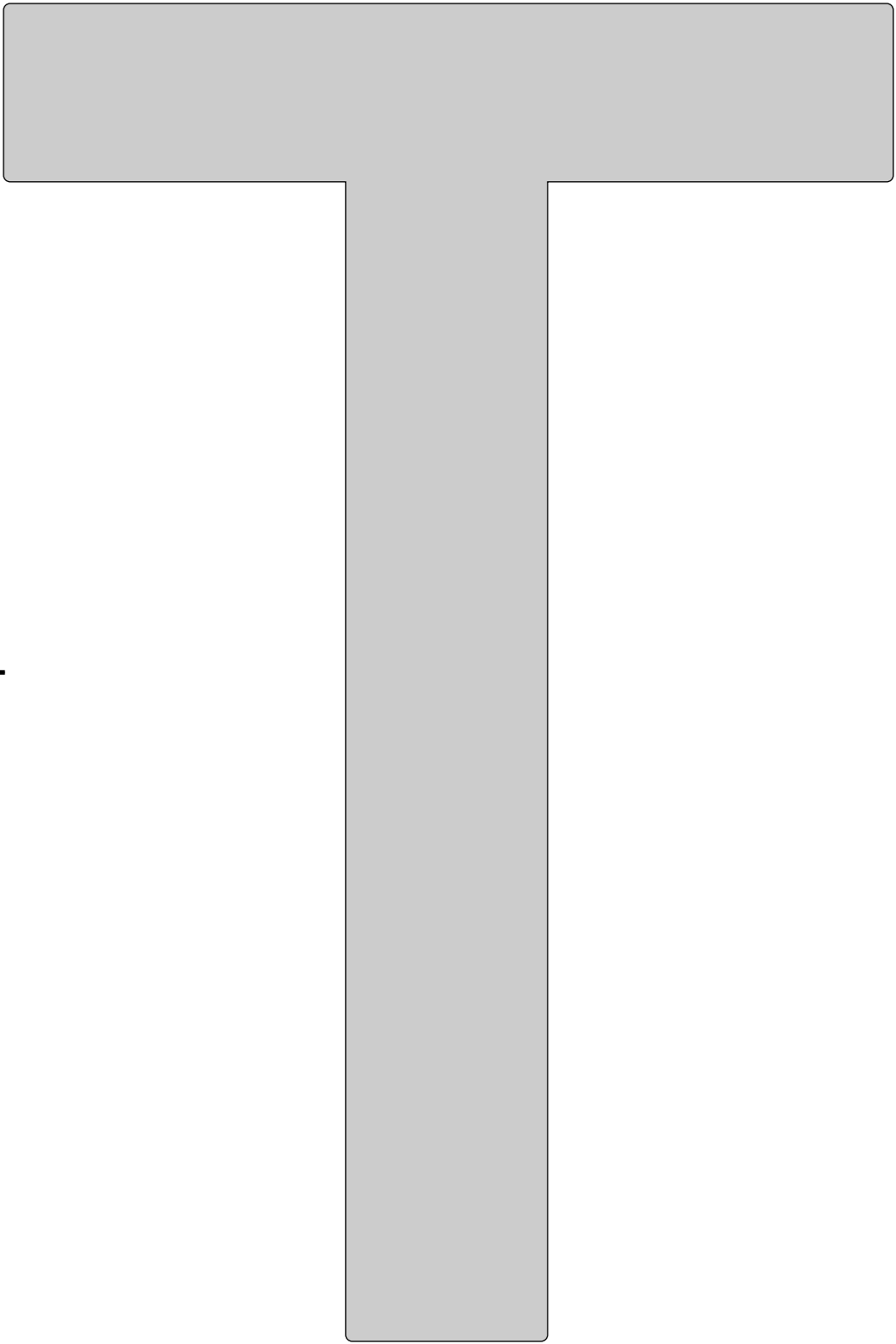

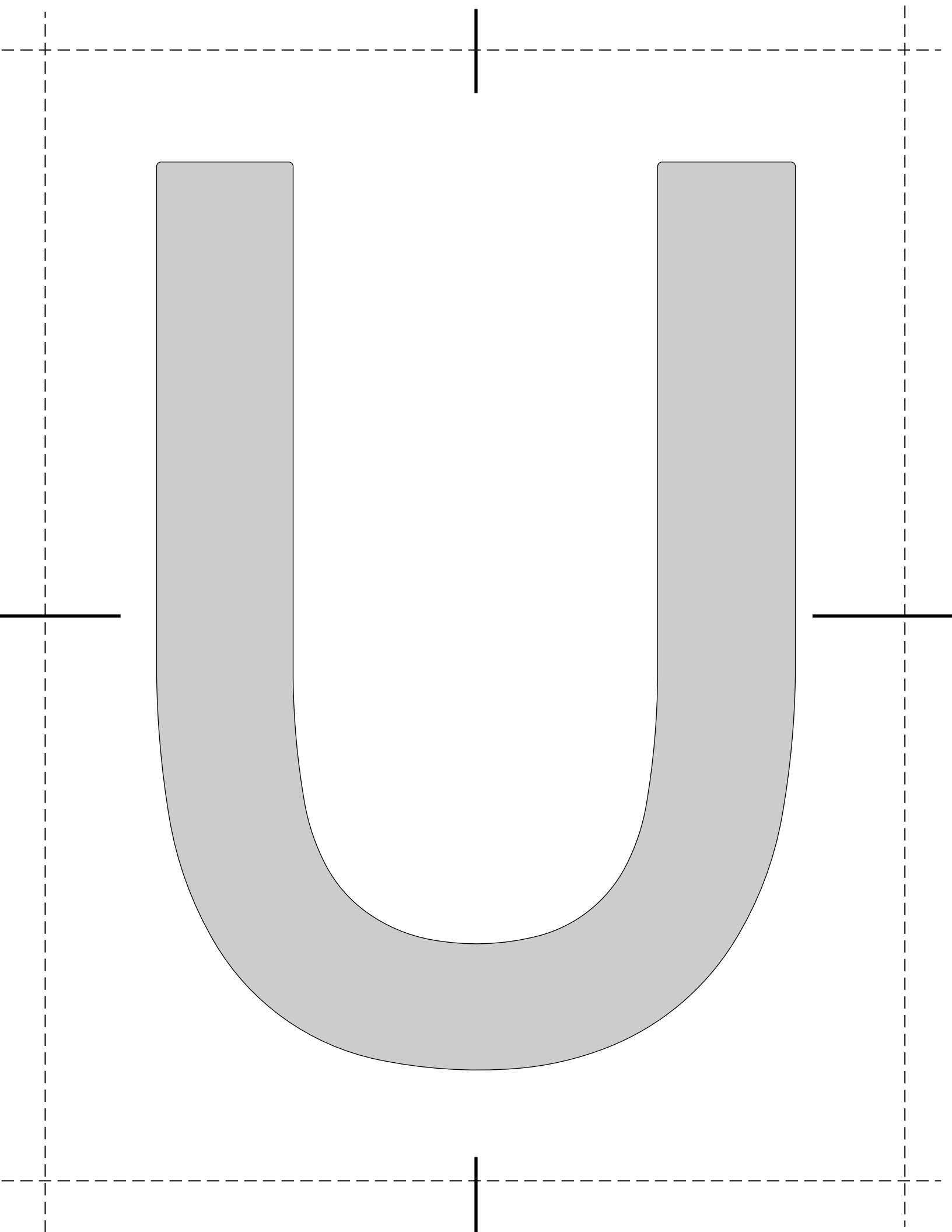

Letter V  
page 1 of 2  
center of letter is where the pages meet.  
Tape the pages together with no overlap



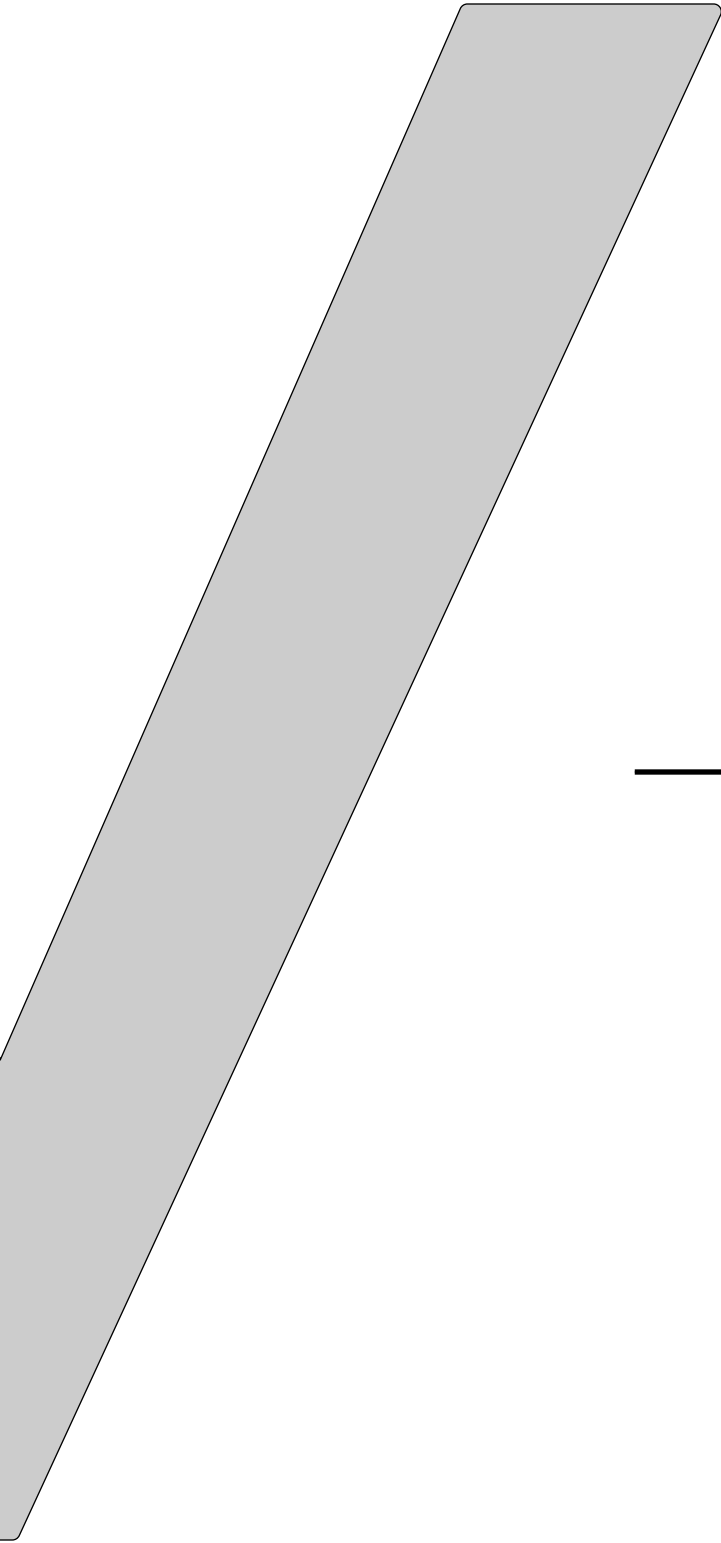

Letter W

page 1 of 2

center of letter is where the pages meet.

Tape the pages together with no overlap







