

LETTERCUT

CAPITAL LETTER TEMPLATE 5 inch BOLD RETRO

INSTRUCTIONS:

1. Print template pages at full size for accuracy.
2. Assemble template.
3. Tape the template in place.
Use a level to ensure your template is straight.
4. Pre-drill the screw holes - using house numbers as a guide.
5. Fasten with screws through the number and spacer.

Horizontal alignment:

Assemble the template so these solid lines match on each page for horizontal words. Use the lines on the top and bottom of page for vertical words. When you assemble your template - tape pages together so solid lines line up.

Heights vary slightly - Numbers and letters are all designed for visual appeal. A slight variation in number height and width is intentional.

Spacing your letters :

These dotted lines create even spacing of letters
Fold template on the dotted line and tape papers together so dotted lines match.
*Easily add or subtract space by adding or decreasing space between dotted lines.

Suggested spacing between 5" tall letters:
For horizontal placement is 0.75 - 1.25" between letters.
For vertical placement - allow 1 - 1.5" between letters.

LETTERCUT

For letter - print page:

- A - page 3
- B - page 4
- C - page 5
- D - page 6
- E - page 7
- F - page 8
- G - page 9
- H - page 10
- I - page 11
- J - page 12
- K - page 13
- L - page 14
- M - page 15
- N - page 16
- O - page 17
- P - page 18
- Q - page 19
- R - page 20
- S - page 21
- T - page 22
- U - page 23
- V - page 24
- W - page 25 + 26
- X - page 27
- Y - page 28
- Z - page 29

Send Jane an email: Jane@MyLettercut.com
if this template does not work for you

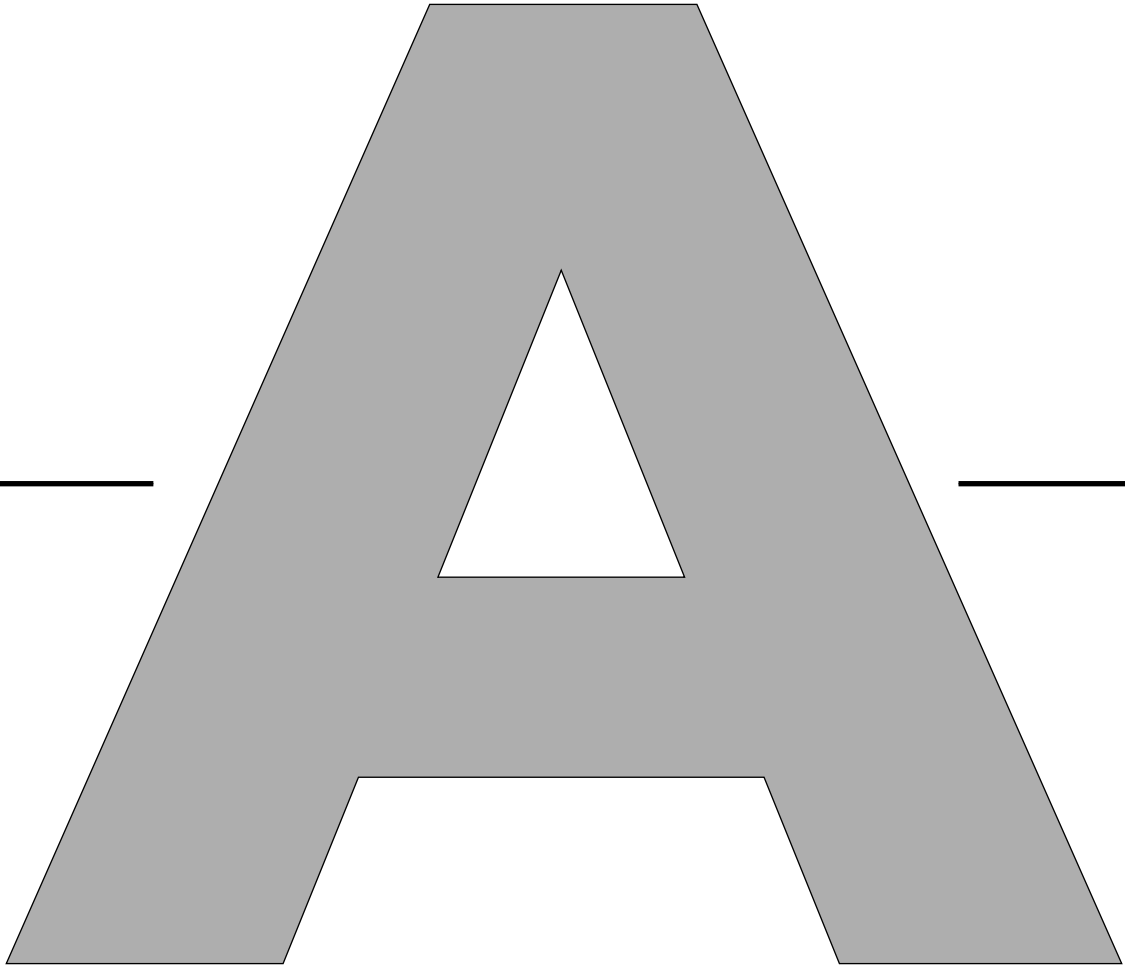

B

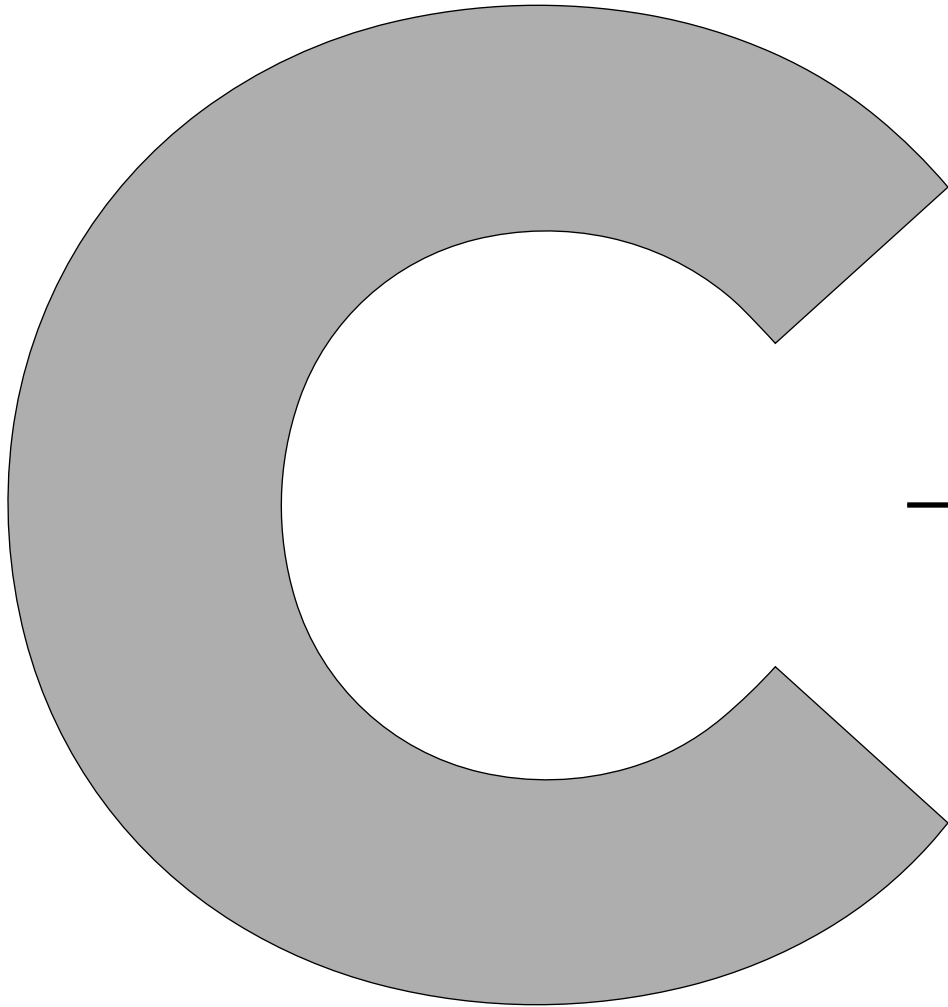



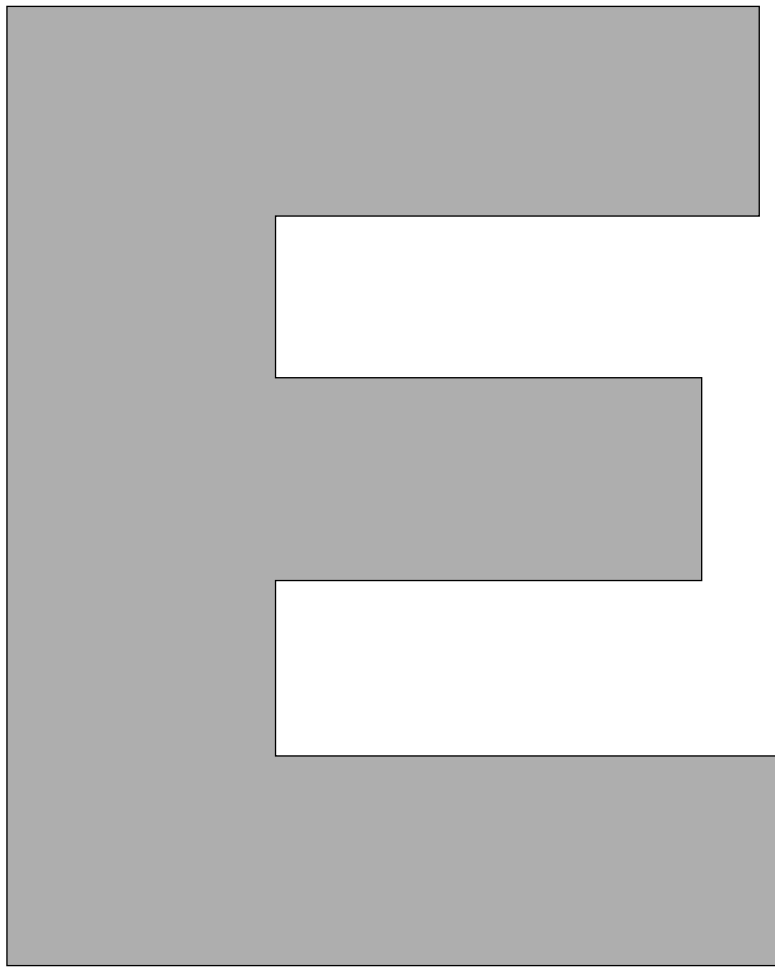

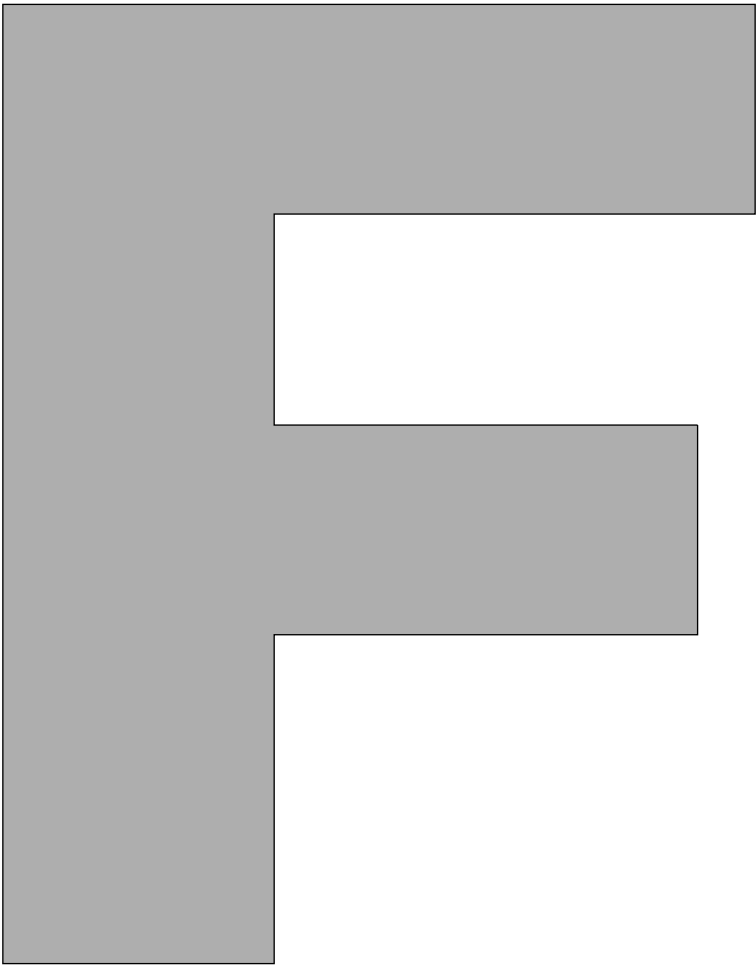



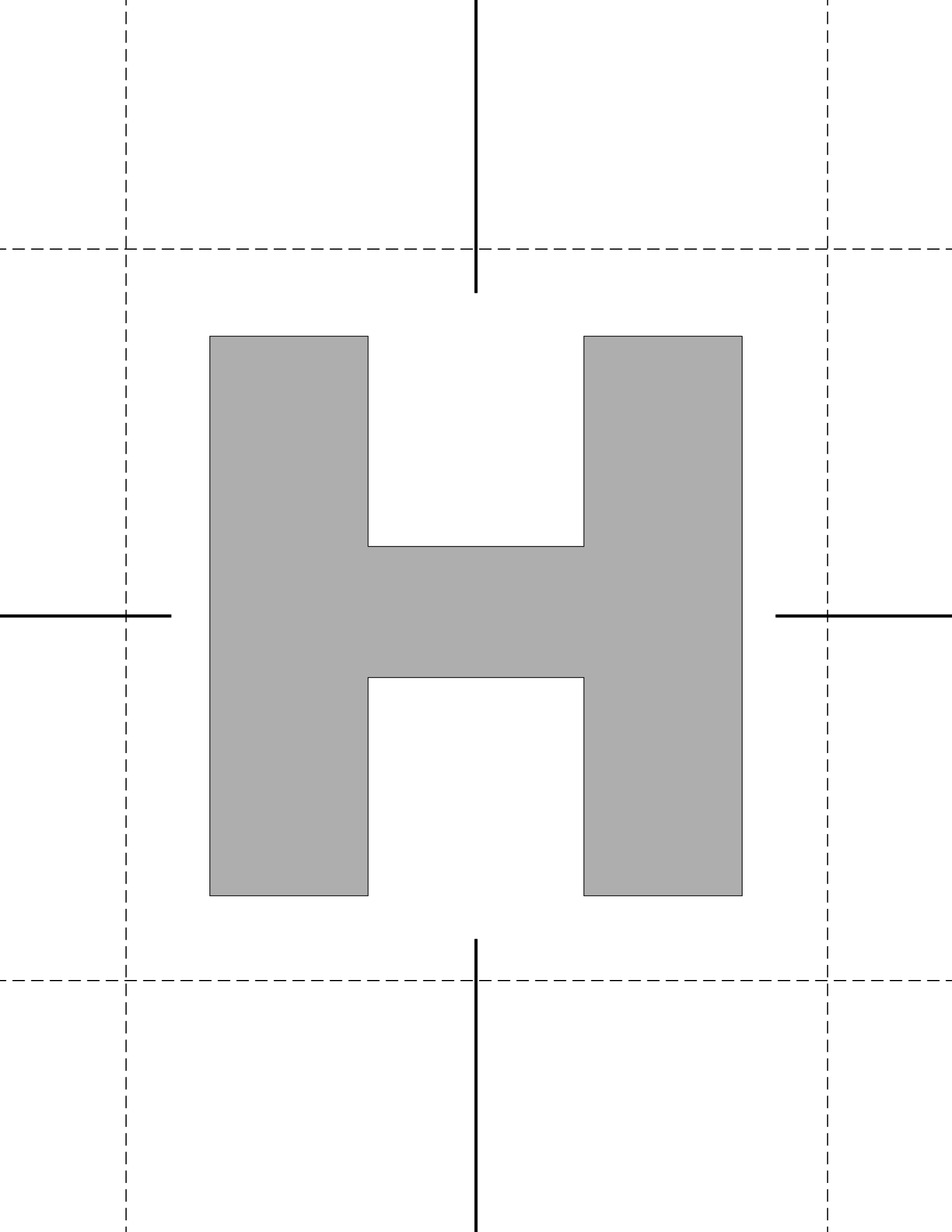

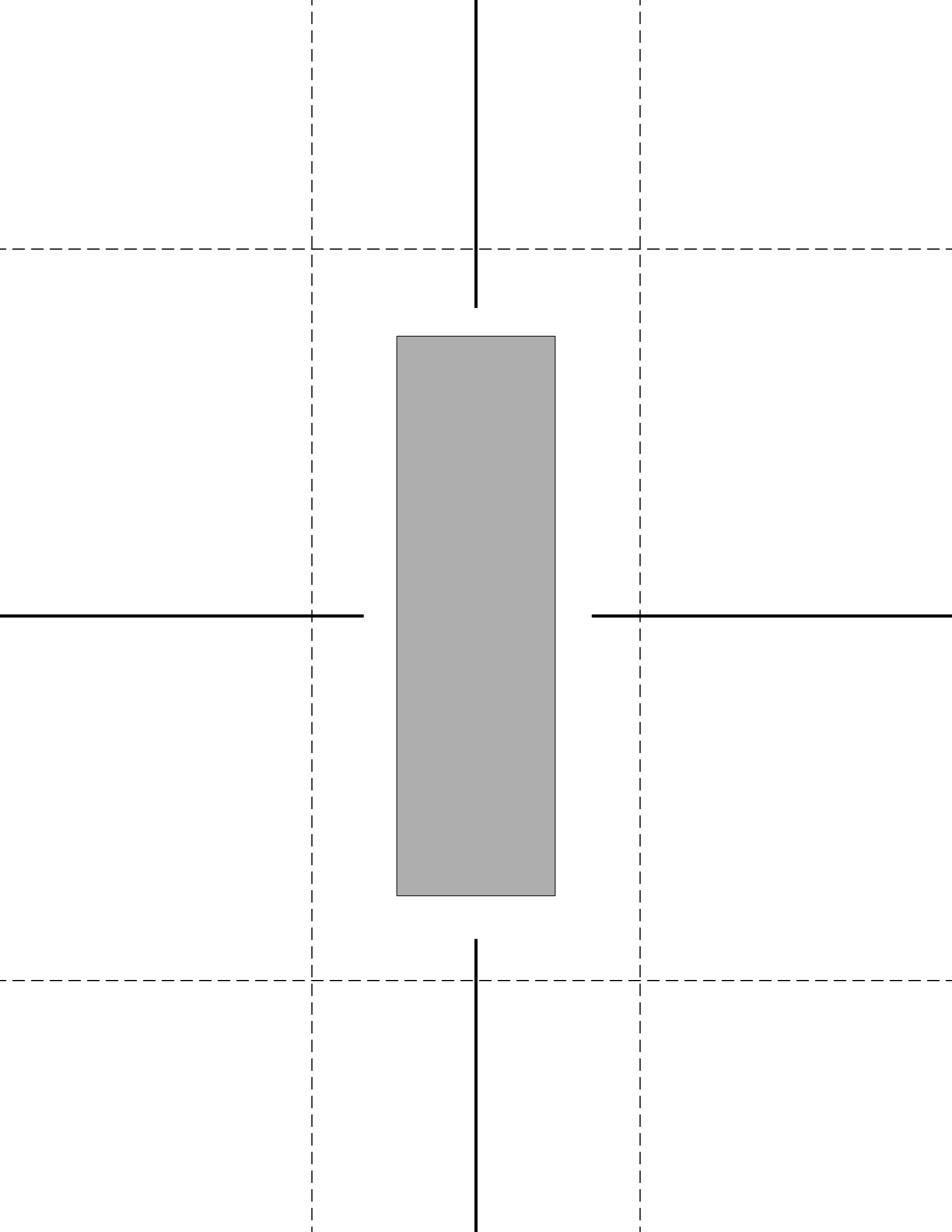

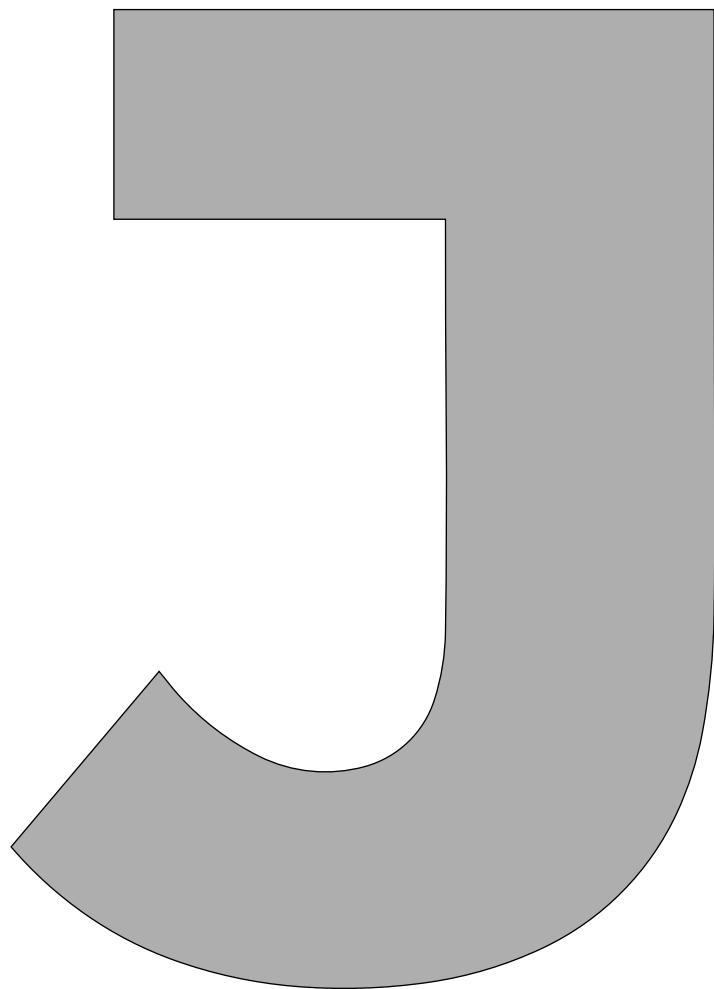

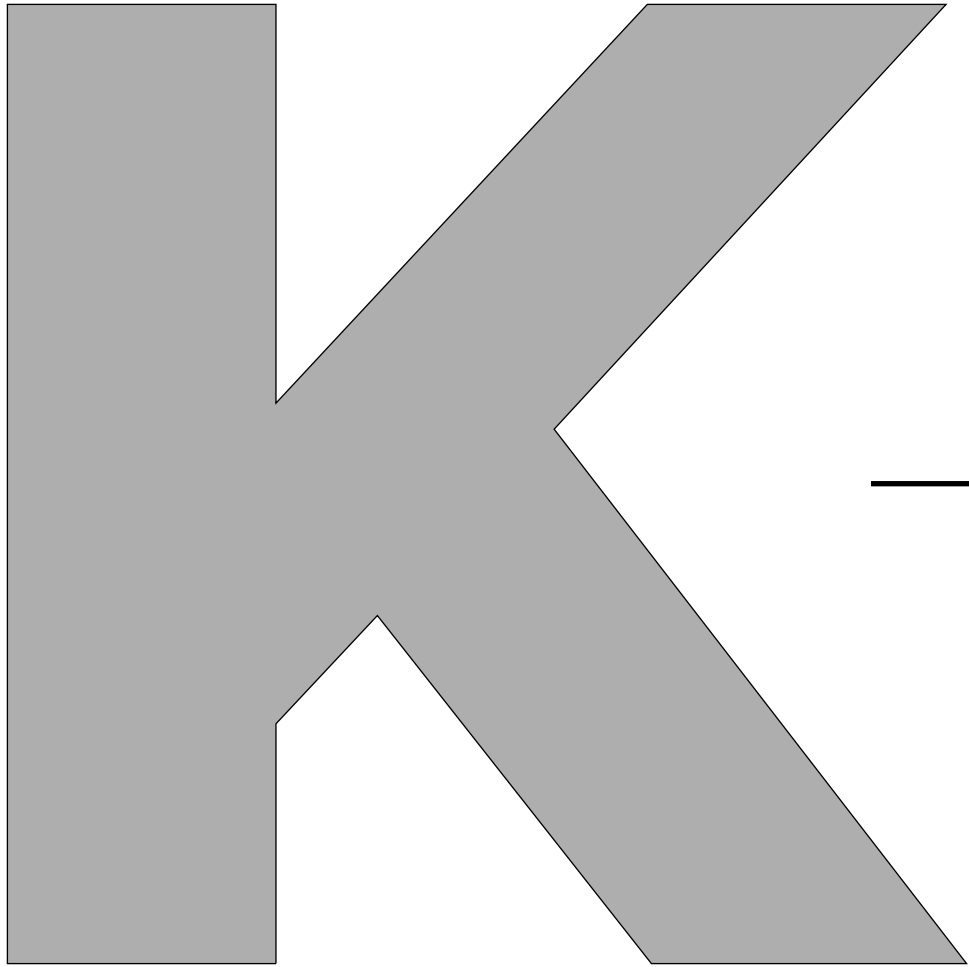

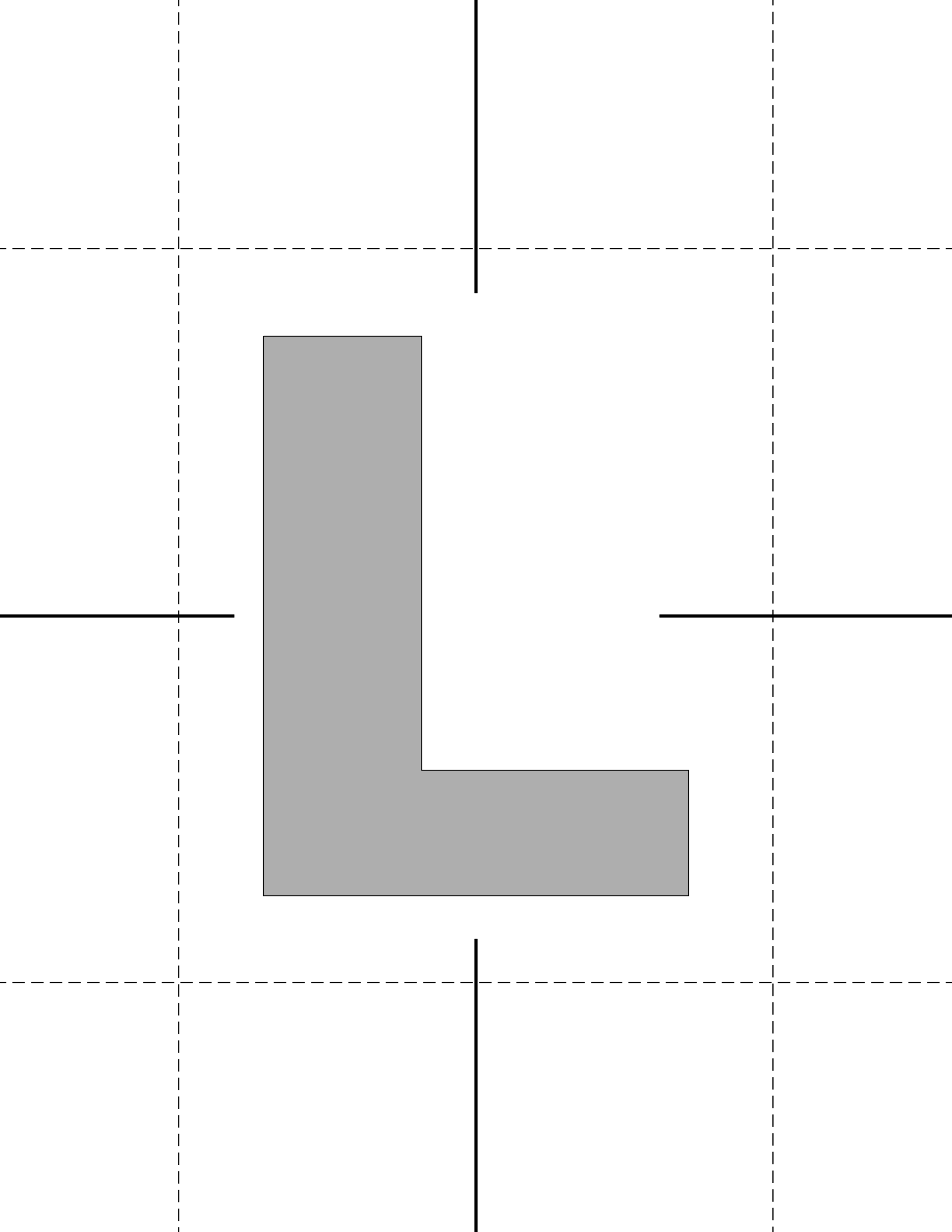



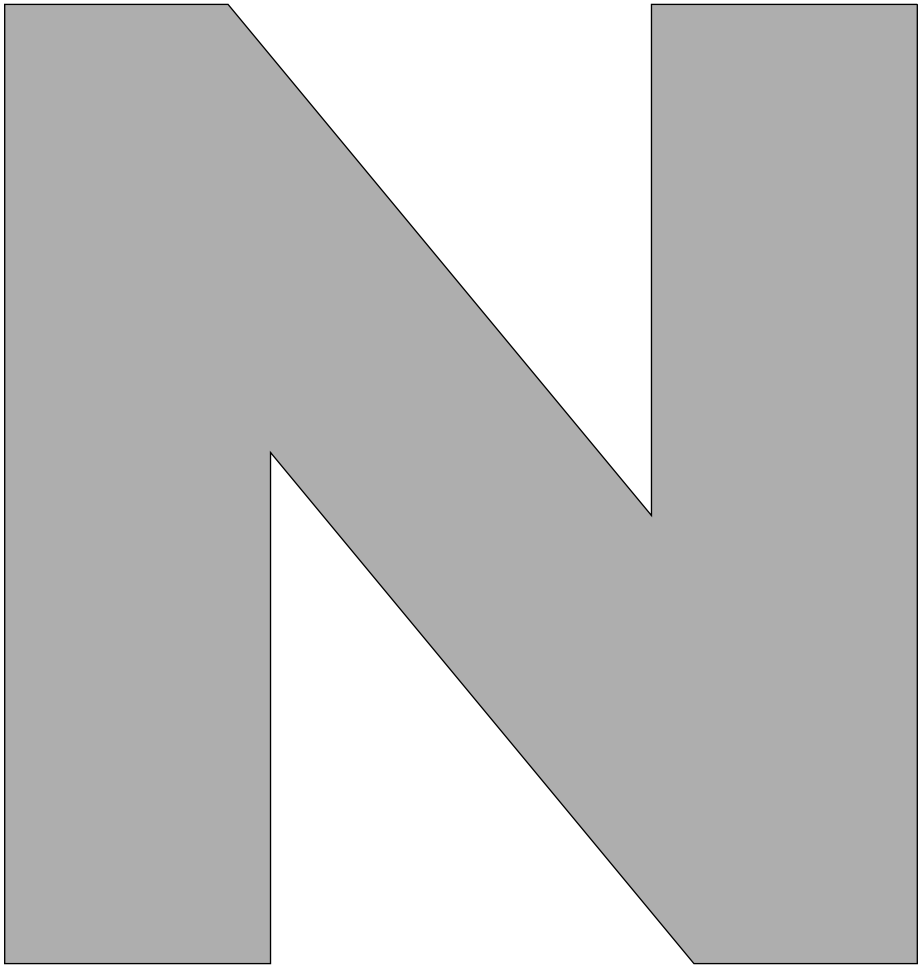

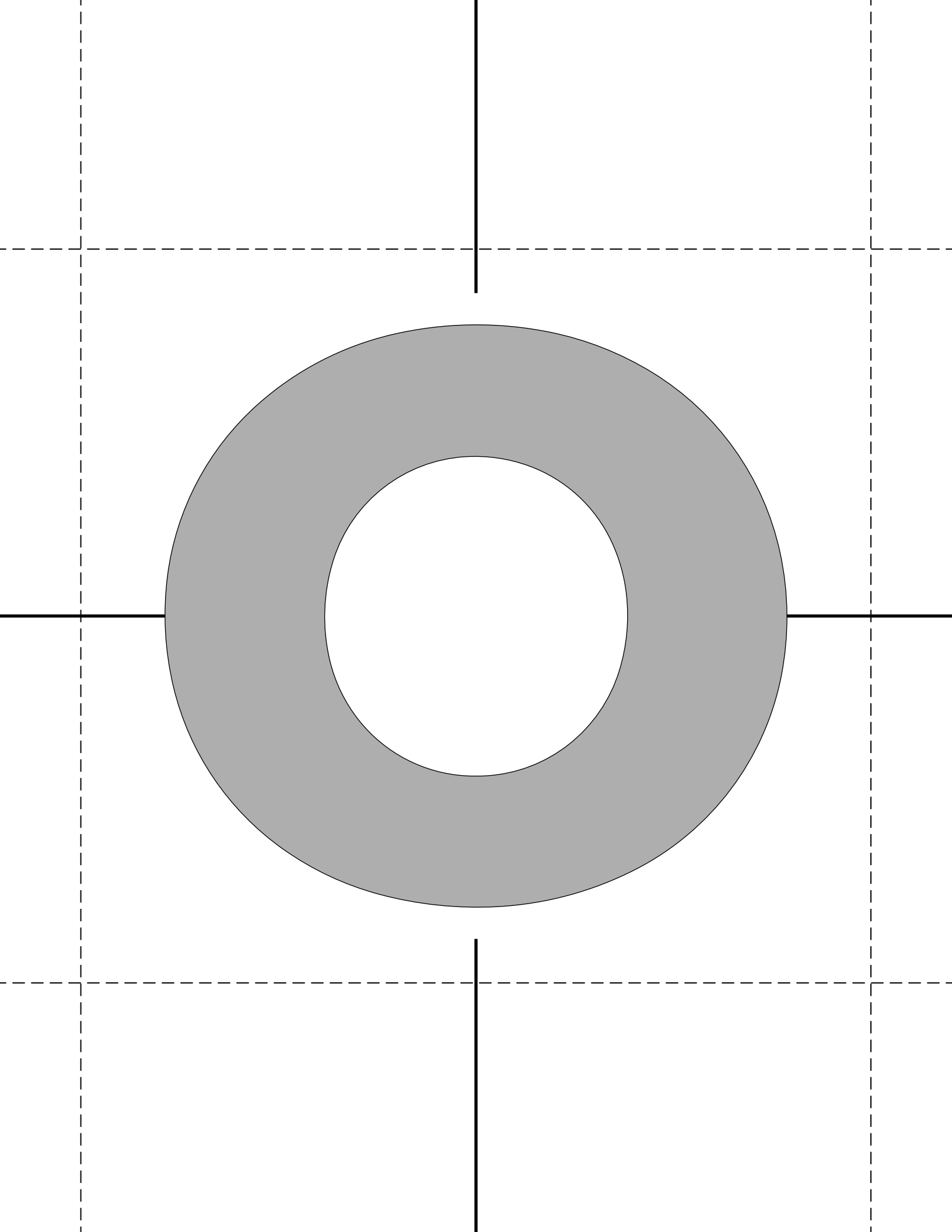

P

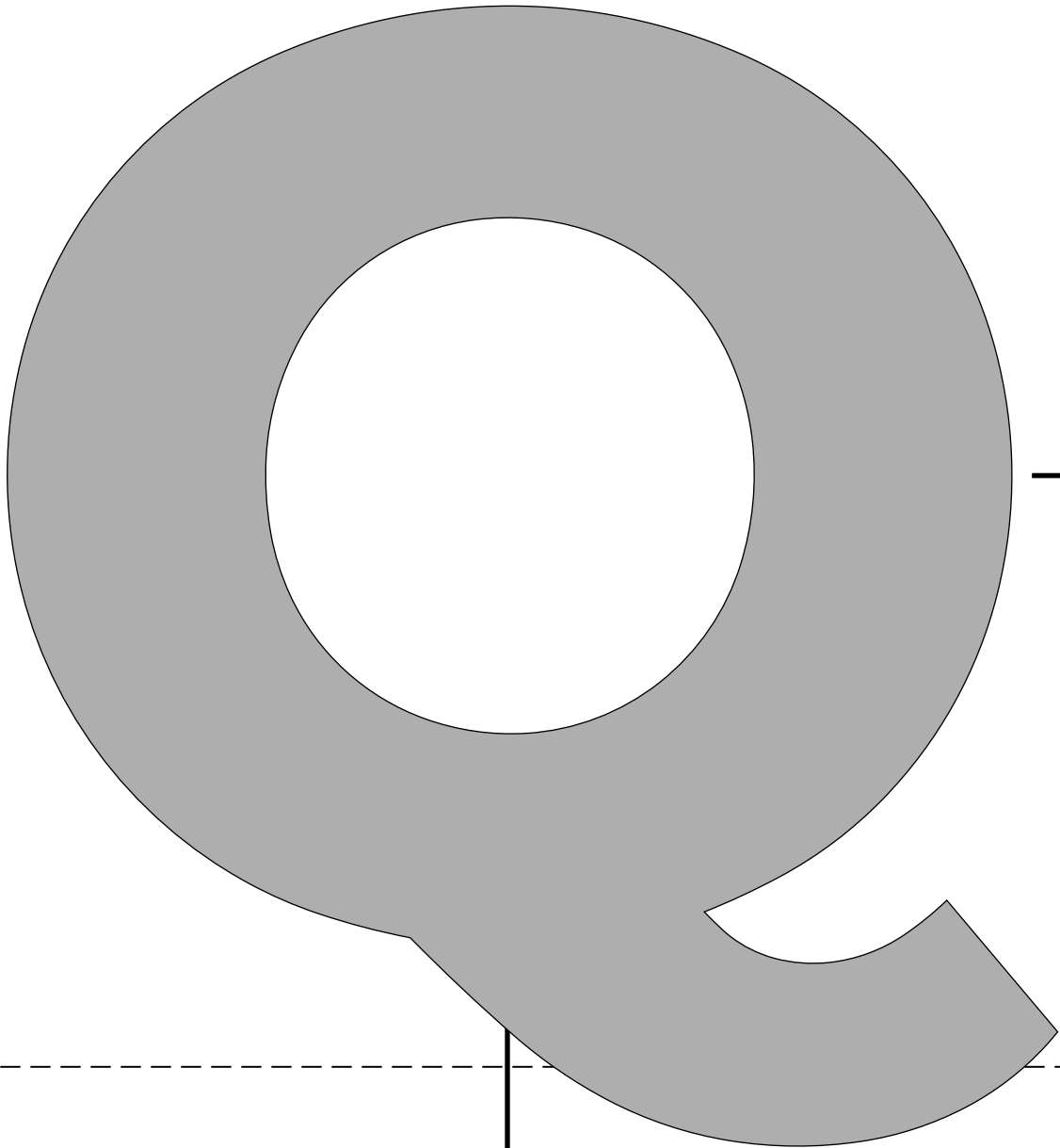

R

S

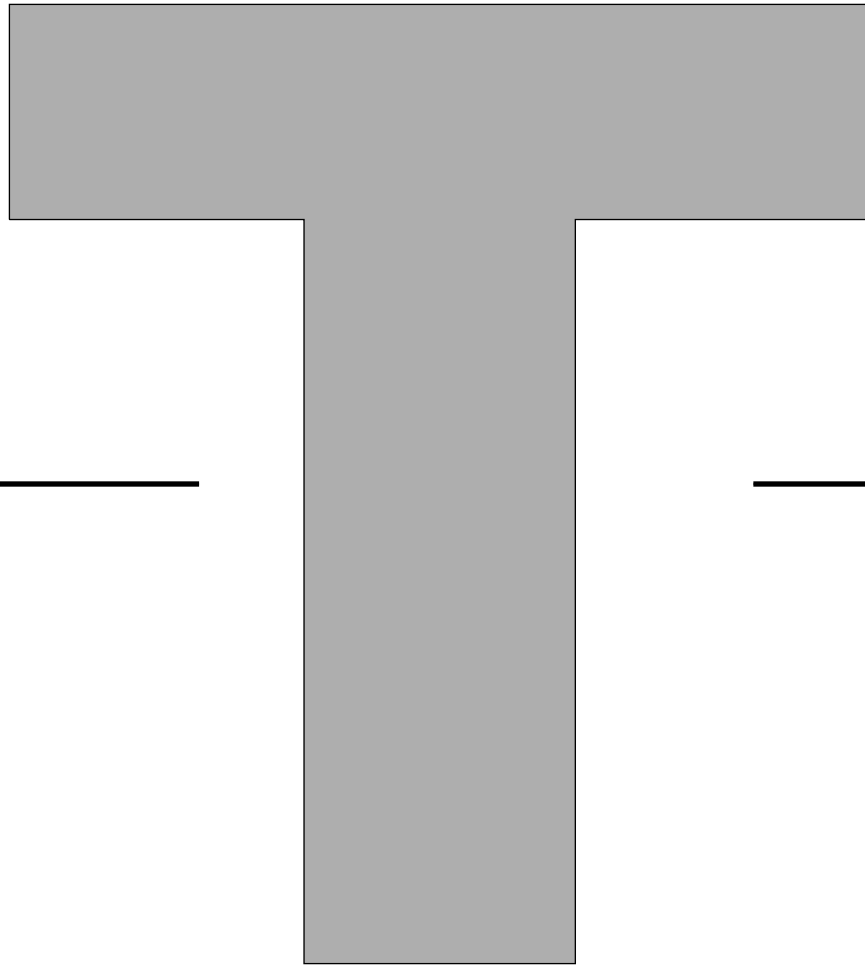

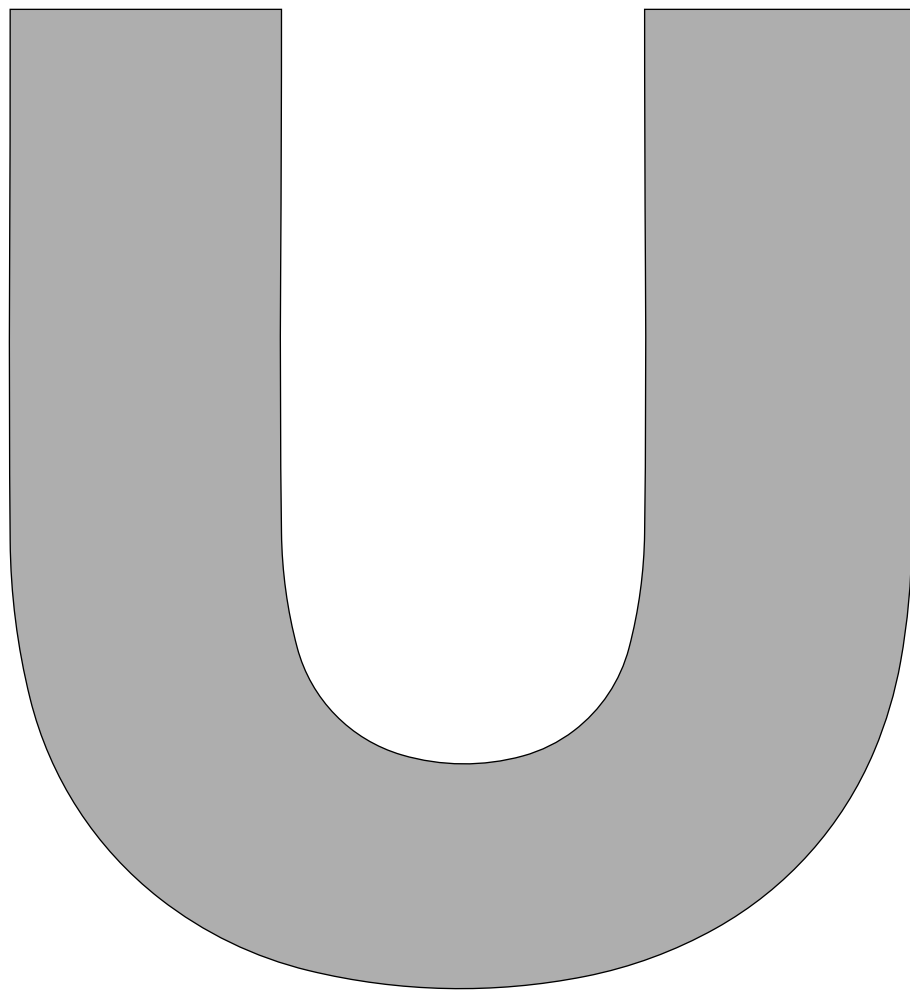

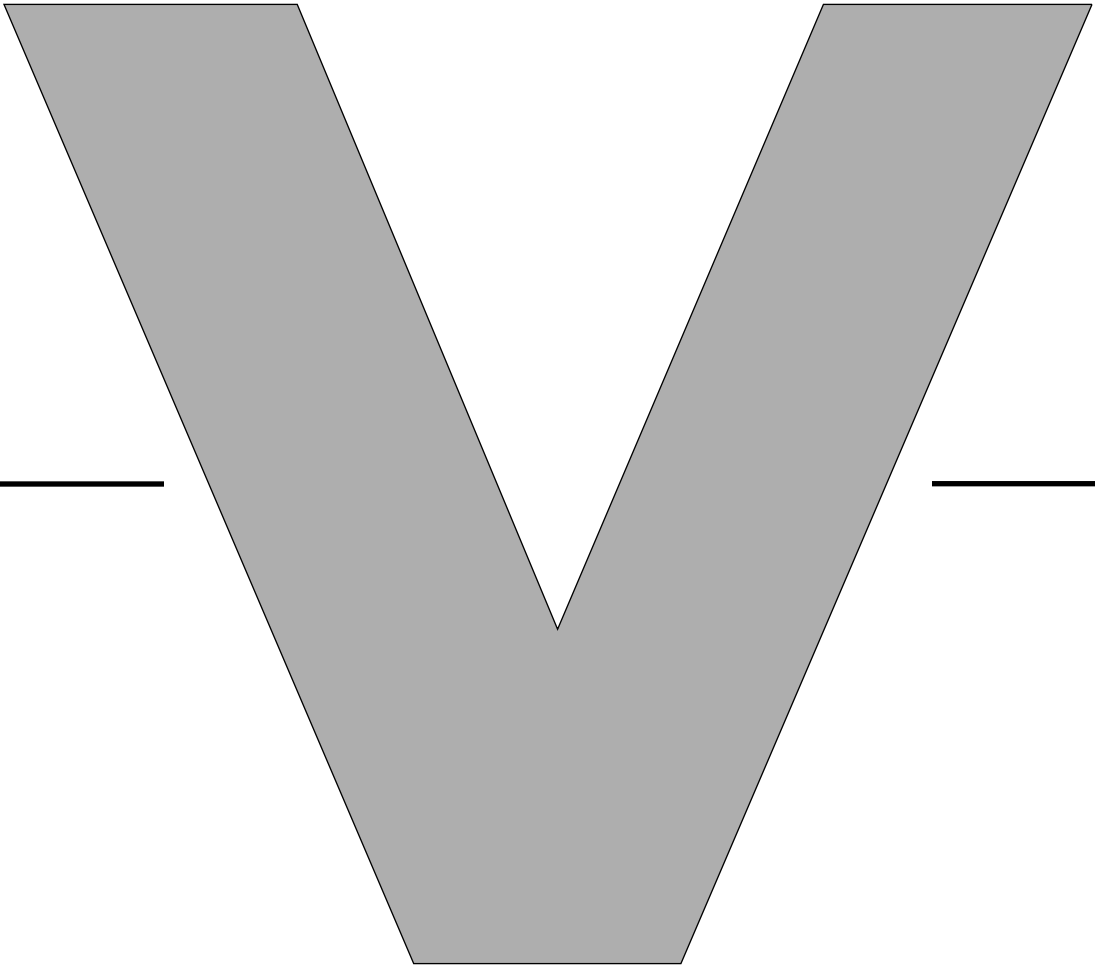

Letter W
page 1 of 2
center of letter is where the pages meet.
Tape the pages together with no overlap

