

## CS19038-2

Customer Name	Qualimax LTD
Length	6.0m
Width	2m
Wall Height	1.2m
Apex Height	2m
Arch Distance	1.0m







# Greenhouse Pack you



Unpack →

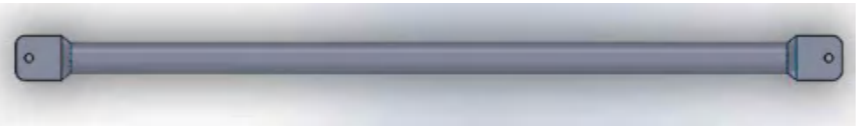

# Material List for one set

Item NO.	Commodity	Picture	Dimension	Length(m)	Quantity
1	Half arch-1		25*1.2mm	1.0m	7
2	Half arch-2		25*1.2mm	0.73m	14
3	Column		25*1.2mm	2.57m	14
4	End Post-1		25*1.2mm	1m	4
5	End Post-2		25*1.2mm	0.94m	4
6	End side horizontal bar-1		25*1.2mm	0.56m	4
7	End side horizontal bar-2		25*1.2mm	0.8m	1









# Material List for one set

8	Strengthen Bars		25*1.2mm	1.5m	2
9	Head of the Purlin Pole		25*1.2mm	1.5m	5
10	Purlin Pole		25*1.2mm	1.5m	10
11	End of Purlin Pole		25*1.2mm	1.65m	5
12	Aluminum Basement -End-1		25*1.2mm	1.0m	2
13	Aluminum Basement -End-2		25*1.2mm	1.05m	2
14	Aluminum Basement -side-1		25*1.2mm	1.5m	4
15	Aluminum Basement -side-2		25*1.2mm	1.55m	4

# Material List for one set

16	Tube Clip		Φ25		200
17	Clamp 25		Φ25		40
18	Spring clip 25-25				20
19	Sliding door		25*1.2mm	0.8m*1.8m	1
20	Self Screw		5.5*20		120
21	Self Screw		5.5*40		12
22	Bolt Nut M6*30				40
23	Locking Profile-1		1.5m/pc	1.5m	6









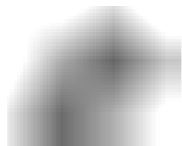

# Material List for one set

24	Locking Profile-2		1.8m/pc	1.8m	4
25	Locking Profile-3		0.8m/pc	0.8m	4
26	Wire for locking profile		1.5m/pc	1.5m	6
27	Wire for locking profile		1.8m/pc	1.8m	4
28	Wire for locking profile		0.8m/pc	0.8m	4
29	Expansion Nuts and Screws		M6		8
30	Expansion Nuts and Screws				4
31	Roof Film		150μm	5.6*3.5m	1

# Material List for one set

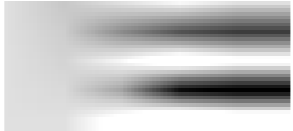
32	End Side Film		150μm	2.5*2.5m	2
33	Tube Clip	 Can be in the place of Black Clamp	Φ25		40
34	Connector of the Locking Profile				6
35	Basement Fixer				4

# Tools (by yourself)

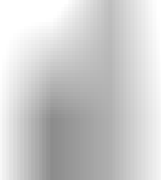
Spanner		Tape Measure	
Safety Gloves		Ladder	
Shovel			
Razor Knives			
Pliers			
Hammer		Drilling machine	
Power Drill			
Angle Grinder			





LIVING CULTURE

# Installation of half arch ,the top of arch

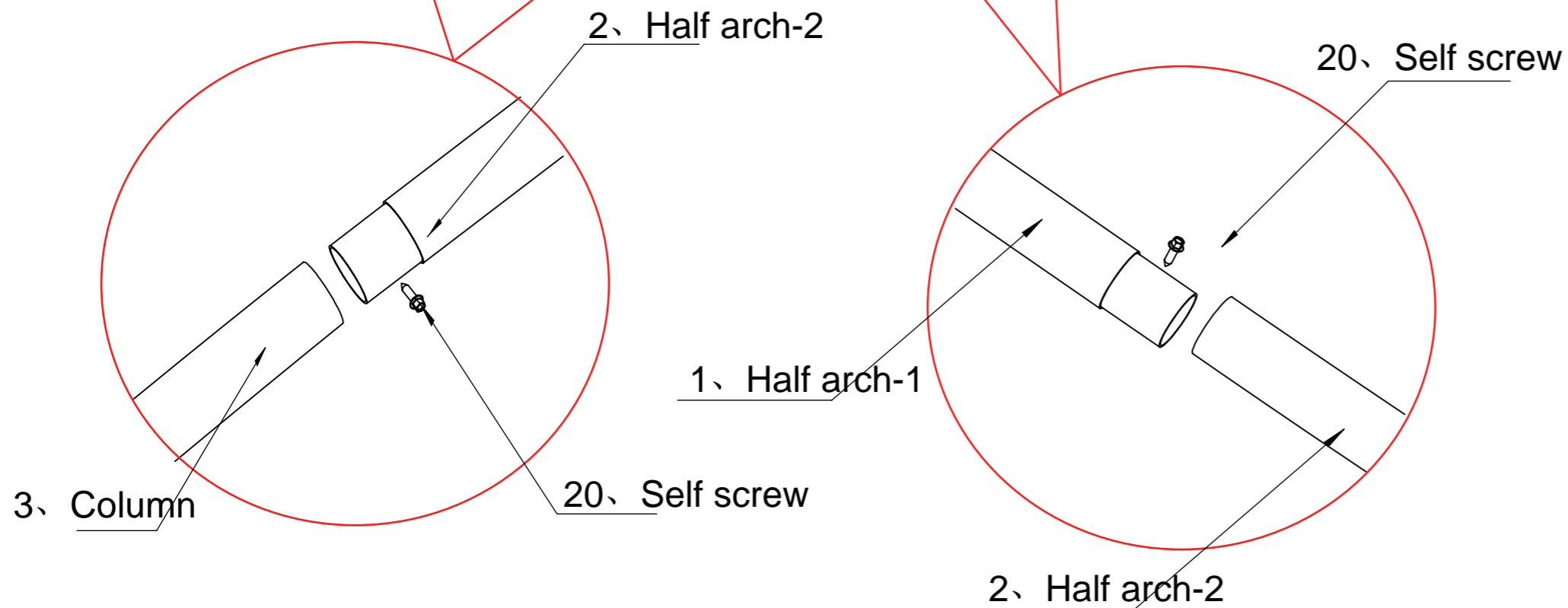
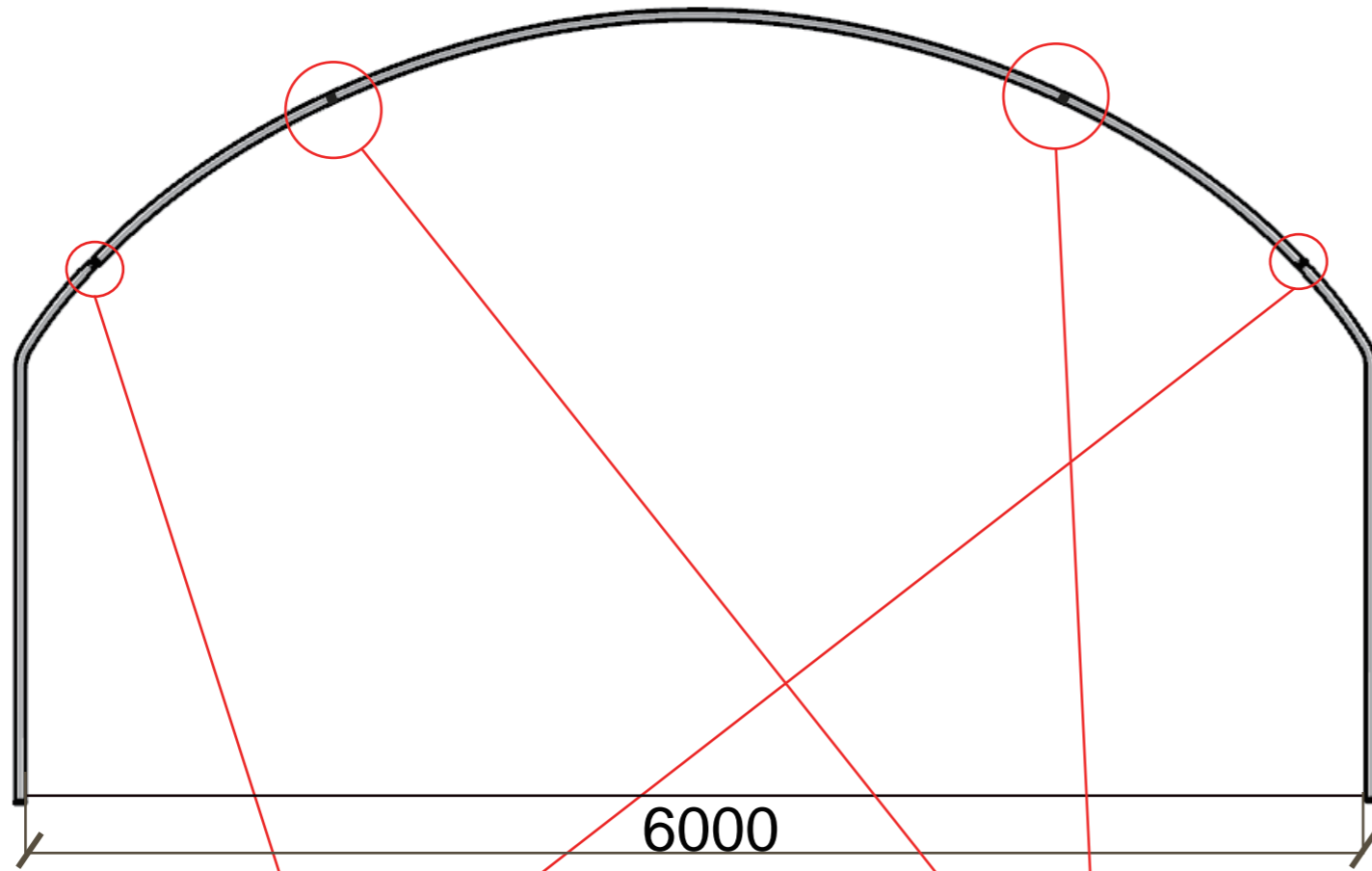

PHOTO AS REFERENCE

Using self screw for connecting of half arch and the top of arch . see the picture.



Company	Qualimax LTD
Designer	LUCY
Auditor	LEO
Scale	1:1000
Date	2021/1/25



# .Installation of head of purlin pole



1、 Half arch

9、 Head of the Purlin Pole

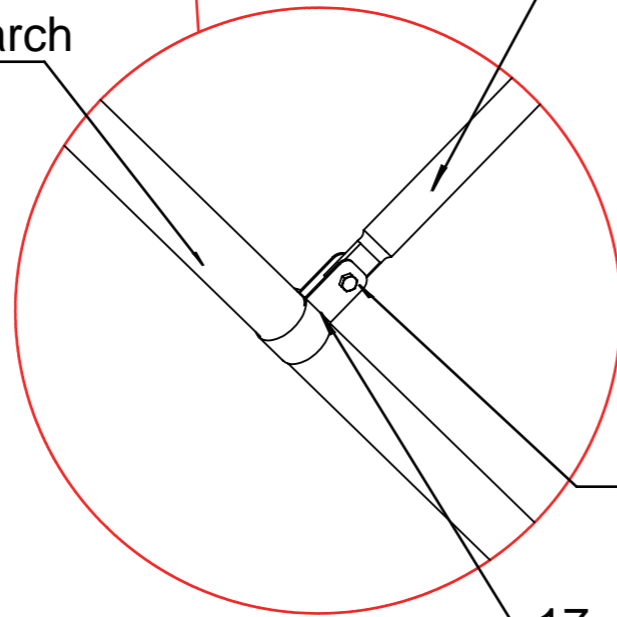

22、 Bolt Nut M6

17、 Clamp 25

The head of purlin pole is connected to the arch by Clamp 25.

## PHOTO AS REFERENCE



Company	Qualimax LTD
Designer	LUCY
Auditor	LEO
Scale	1:1000
Date	2021/1/25



# Installation of Spring clip



PHOTO AS REFERENCE



1. Half Arch

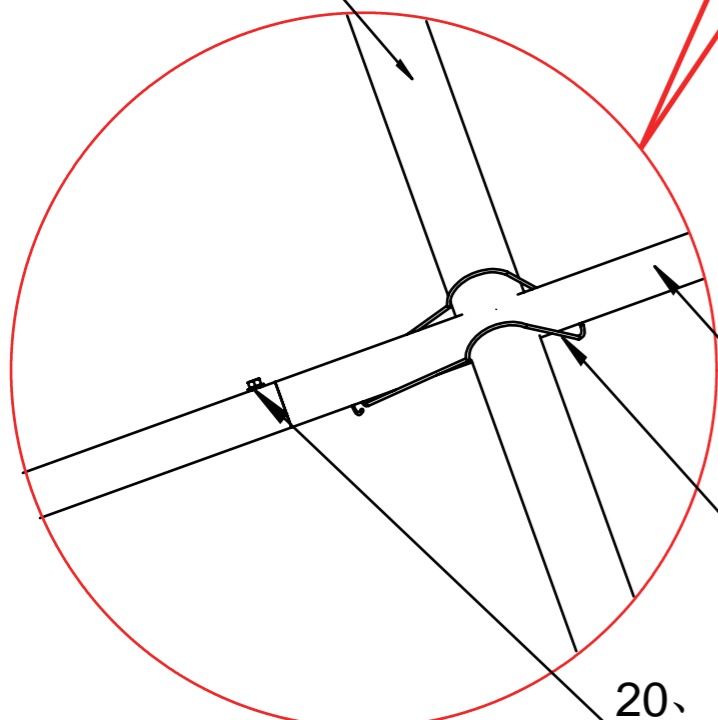

9. Head of the Purlin Pole  
18. Spring clip 25-25

20. Self Screw

9. Head of the Purlin Pole

10. Purlin Pole

11. End of Purlin Pole

1.5m

1.5m

1.5m

1.65m

1. The purlin pole is connected to the arch by spring clip.

Company	Qualimax LTD
Designer	LUCY
Auditor	LEO
Scale	1:1000
Date	2021/1/25



# .Installation of end of purlin pole

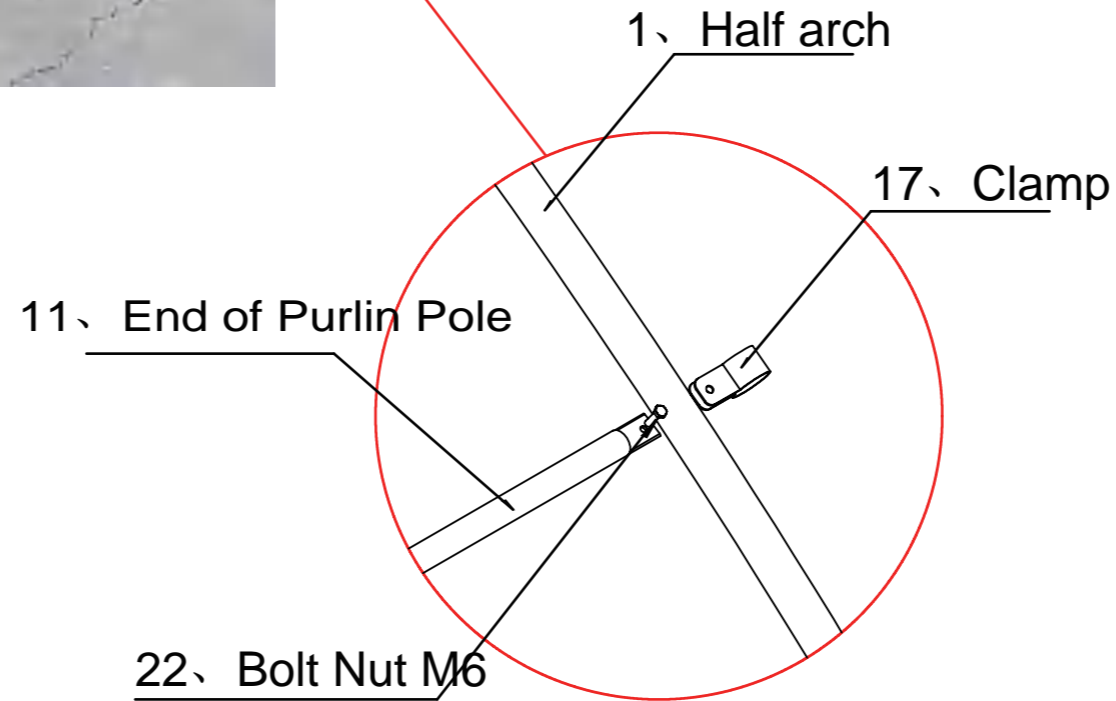

## PHOTO AS REFERENCE



The end of purlin pole is connected to the last arch by clamp 25 and bolt nut M6.

Company	Qualimax LTD
Designer	LUCY
Auditor	LEO
Scale	1:1000
Date	2021/1/25



# Installation of Strengthen Bars

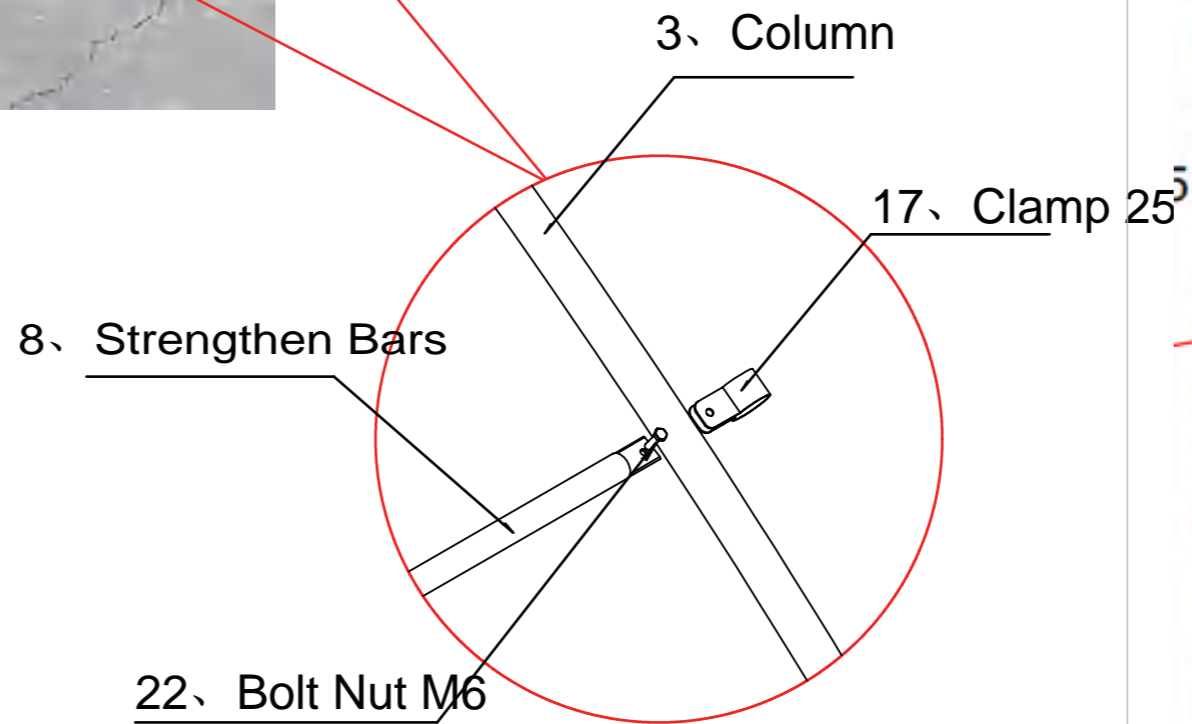

## PHOTO AS REFERENCE



The end of purlin pole is connected to the last arch by clamp 25 and bolt nut M6.

Company	Qualimax LTD
Designer	LUCY
Auditor	LEO
Scale	1:1000
Date	2021/1/25



LIVING CULTURE

### .Installation of End Post

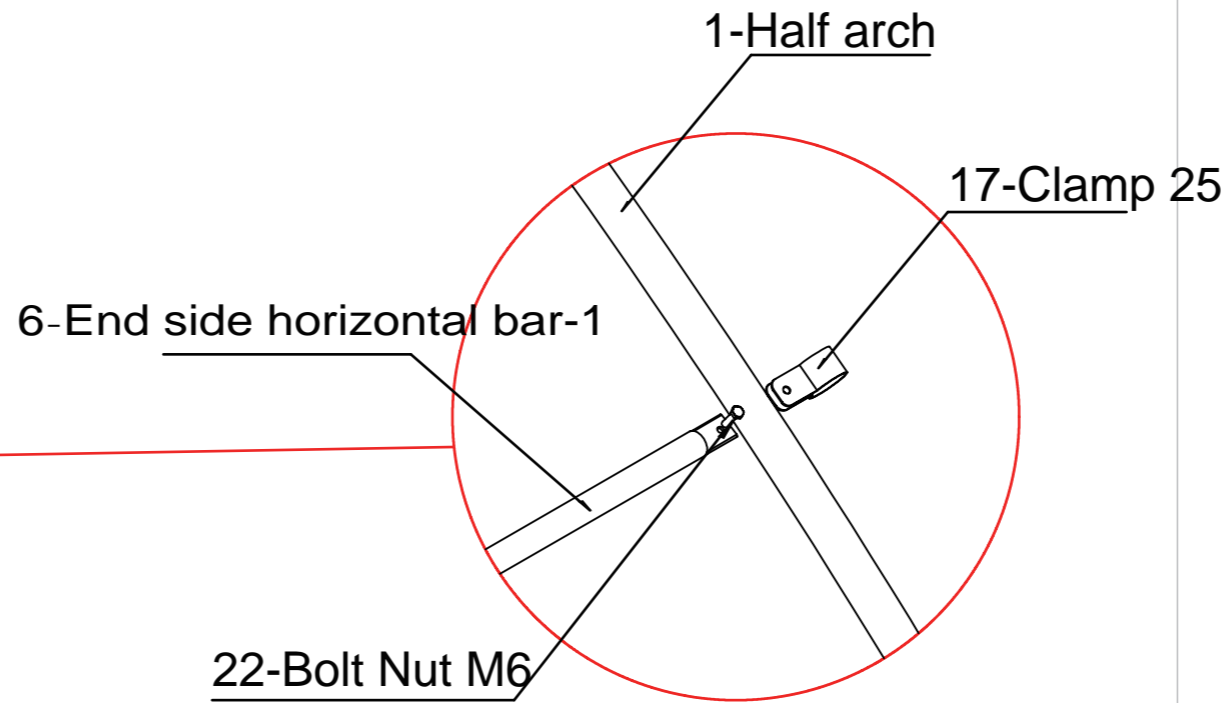
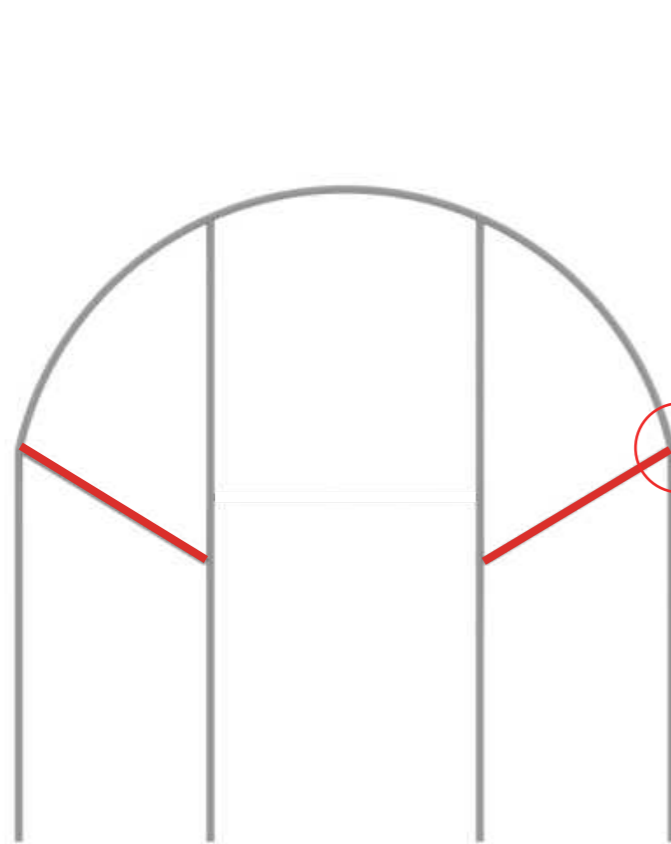
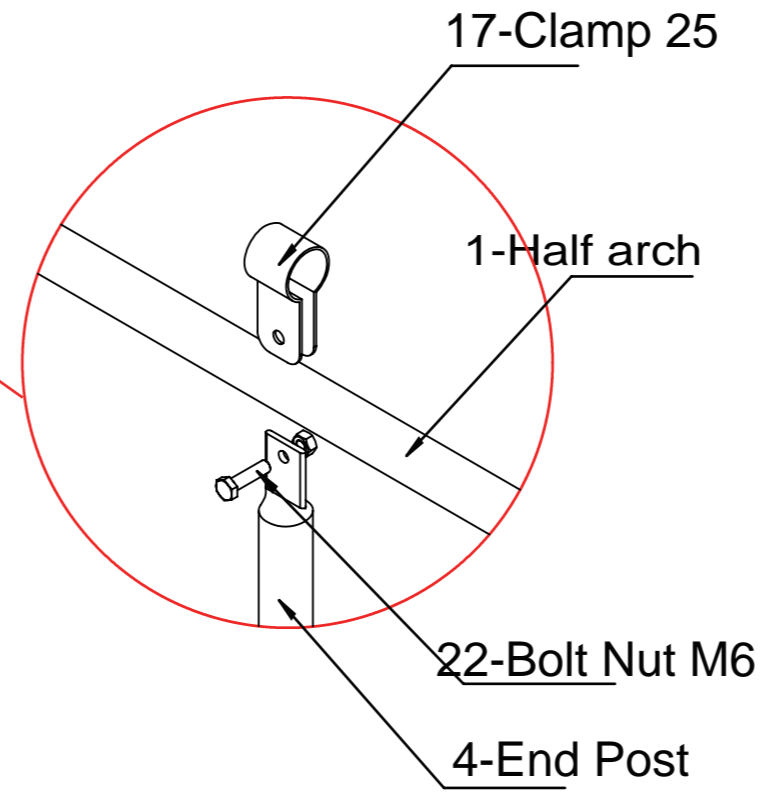
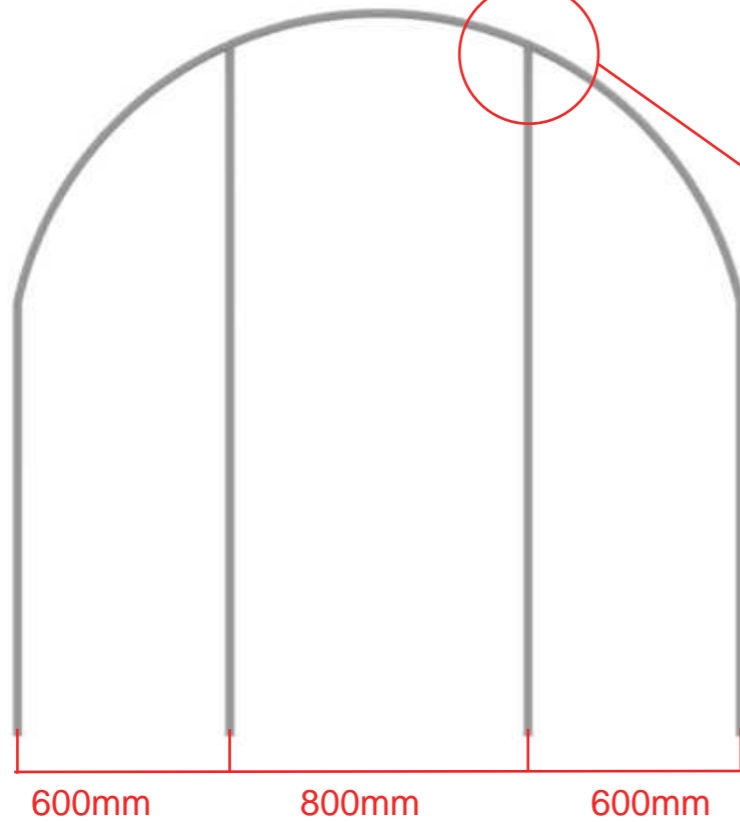
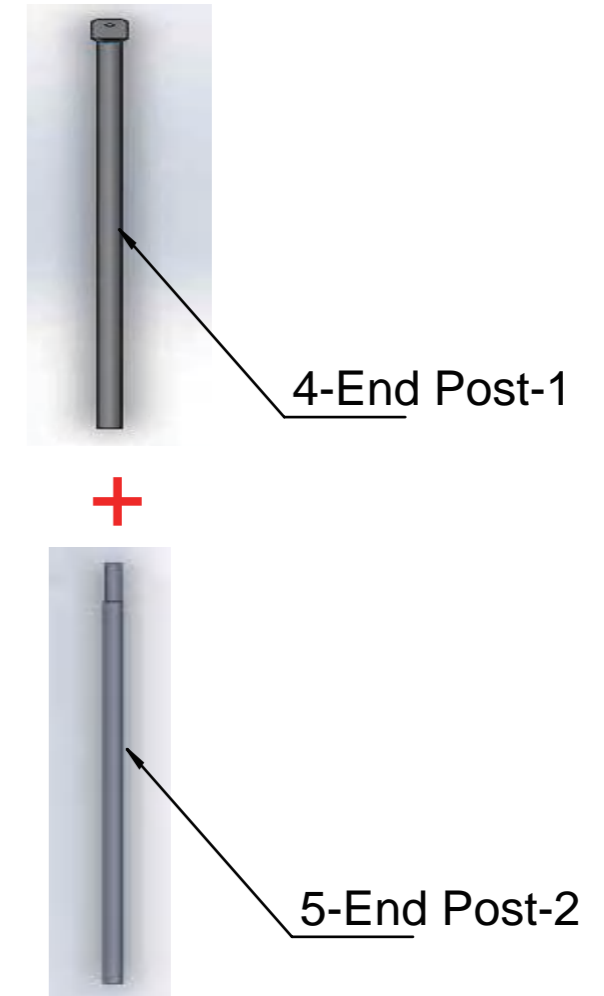

PHOTO AS REFERENCE



Using clamp 25 and bolt nut when connecting half arch and end post.

Company	CHINA AGROTIME LTD
Designer	LUCY
Auditor	LEO
Scale	1:1000
Date	2021/1/25



LIVING CULTURE

# Installation of End Post (Without door)

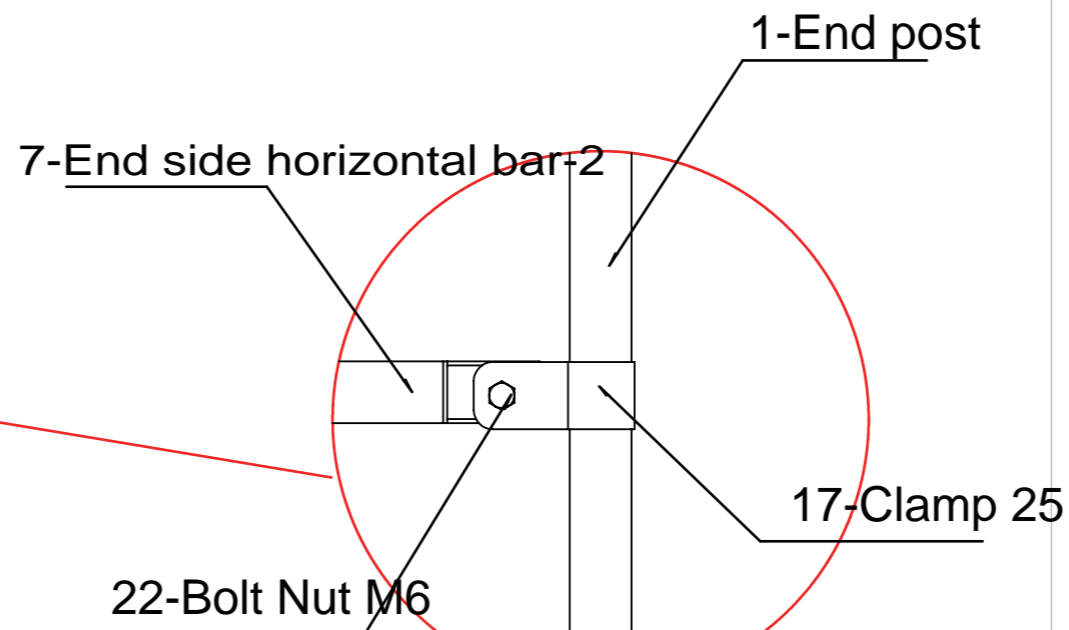
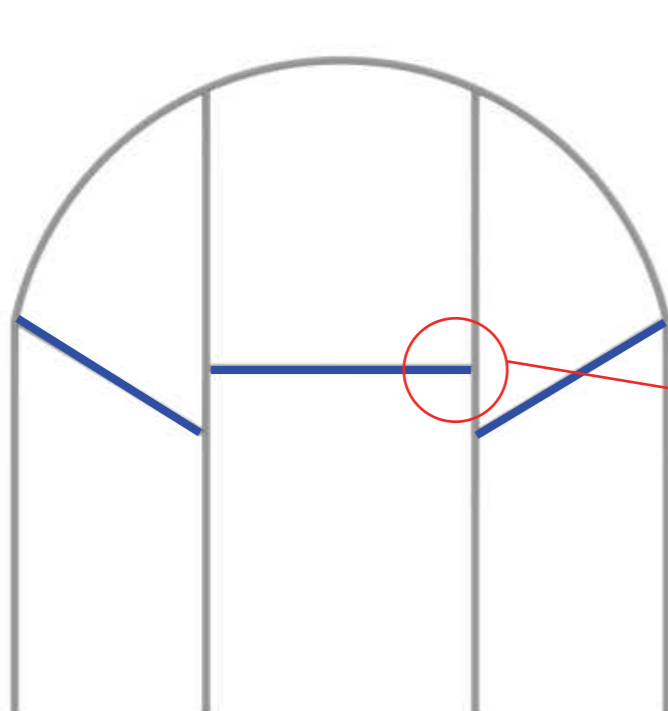
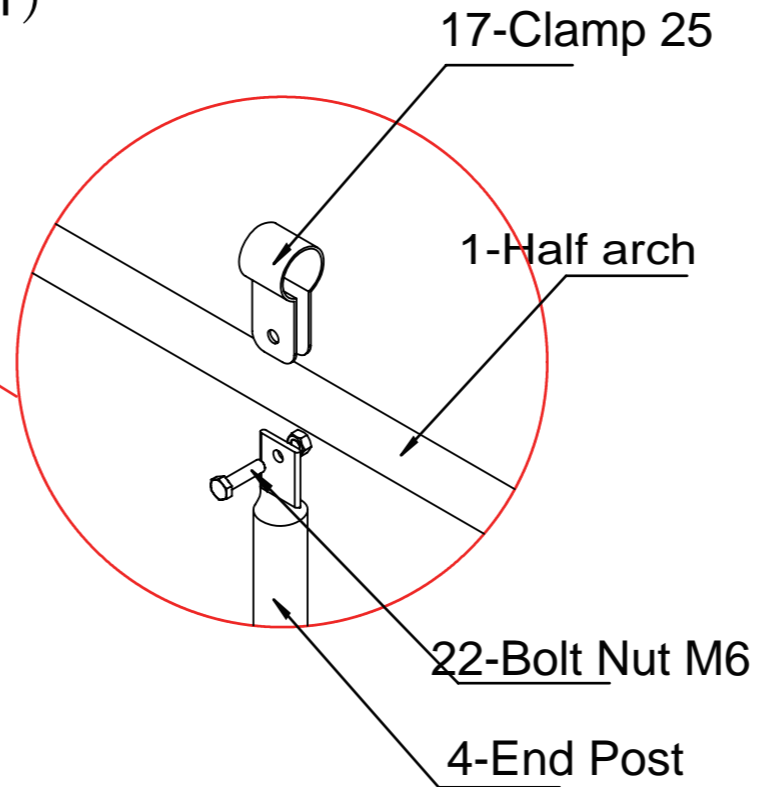
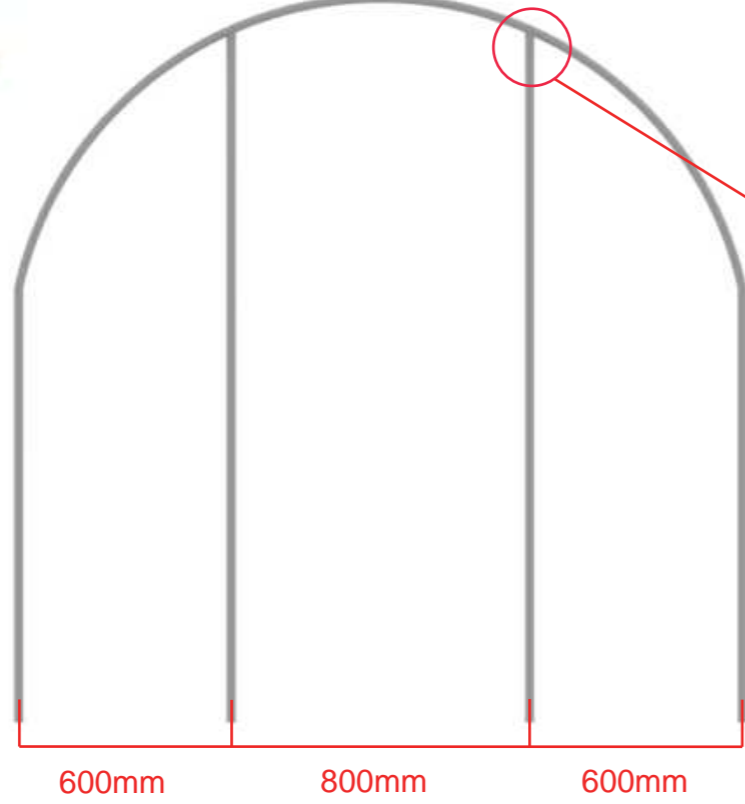
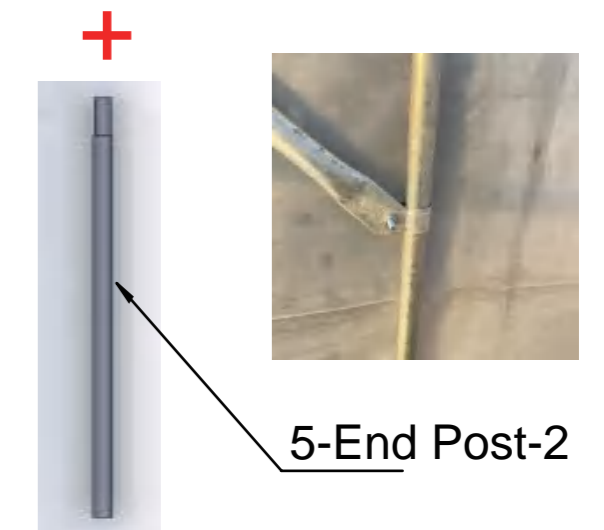
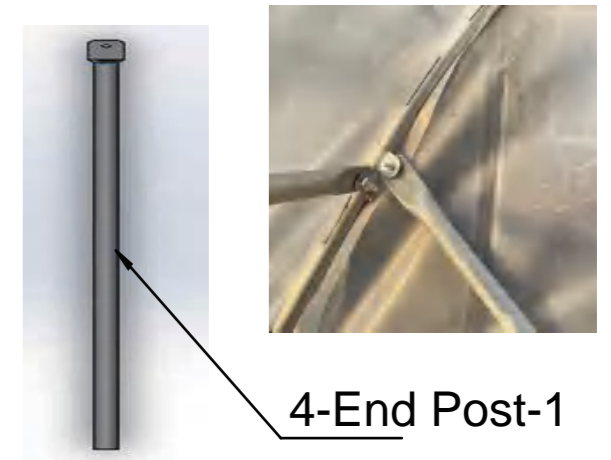
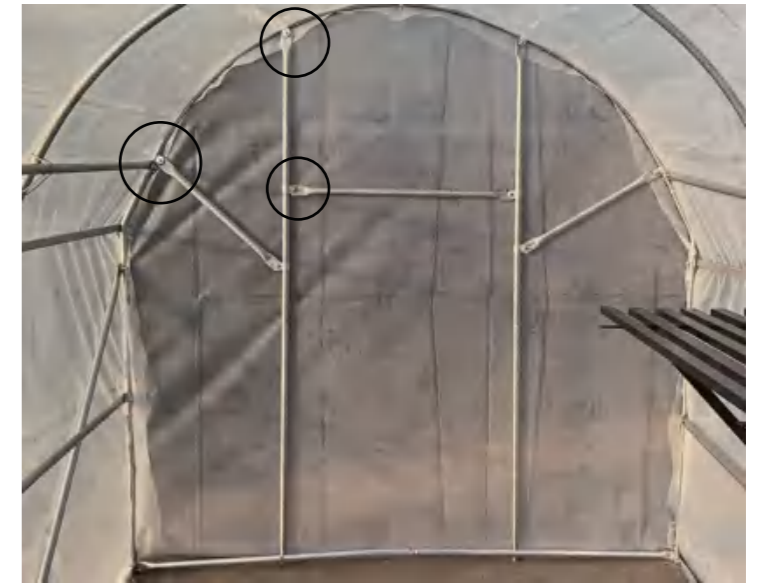

PHOTO AS REFERENCE



Company	Qualimax LTD
Designer	LUCY
Auditor	LEO
Scale	1:1000
Date	2021/1/25



LIVING CULTURE

# Install the bottom frame

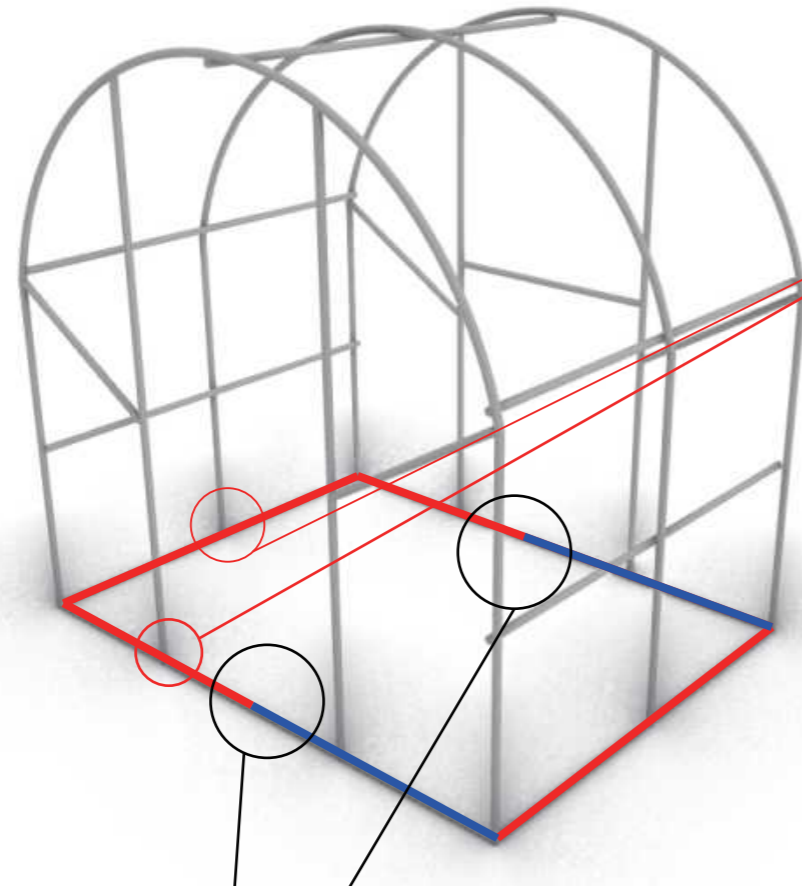

21、 Self Screw

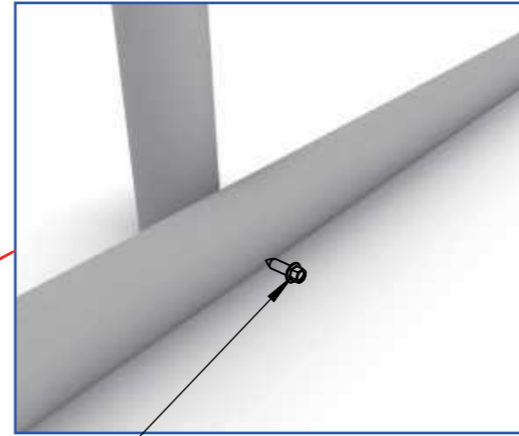

20、 Self Screw

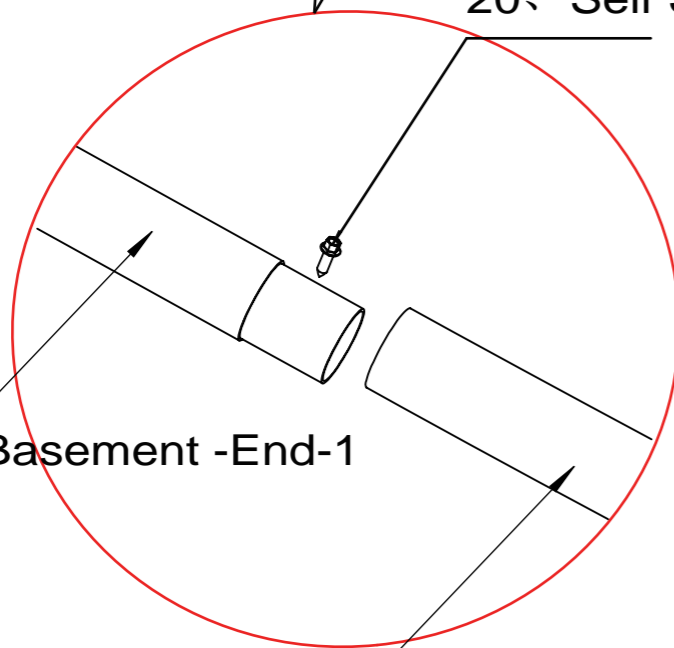

12、 Aluminum Basement -End-1

13、 Aluminum Basement -End-2

Suggestions: Use basement fixer install the greenhouse Base onto concrete floor or Wood Frame for better stability.

## PHOTO AS REFERENCE



Company	Qualimax LTD
Designer	LUCY
Auditor	LEO
Scale	1:1000
Date	2021/1/25





# Installation of locking profile

PHOTO AS REFERENCE



21、 Self Screw

23、 Locking profile-1

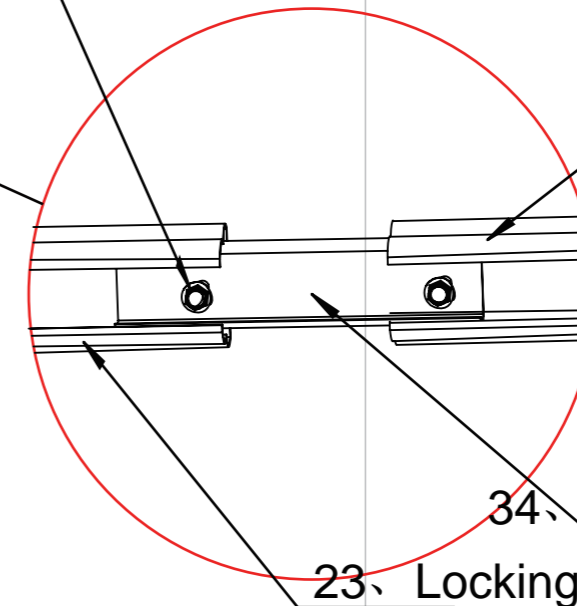

34、 Connector of the locking profile

23、 Locking profile-1

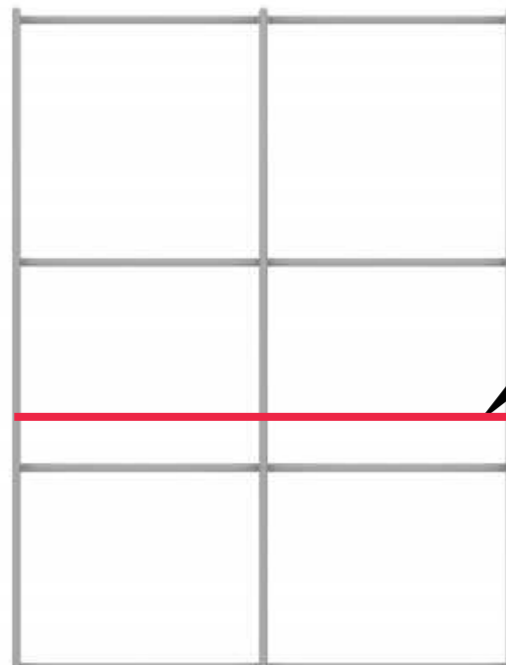

23、 Locking Profile-1



Company	Qualimax LTD
Designer	LUCY
Auditor	LEO
Scale	1:1000
Date	2021/1/25

# Installation of locking profile for end side

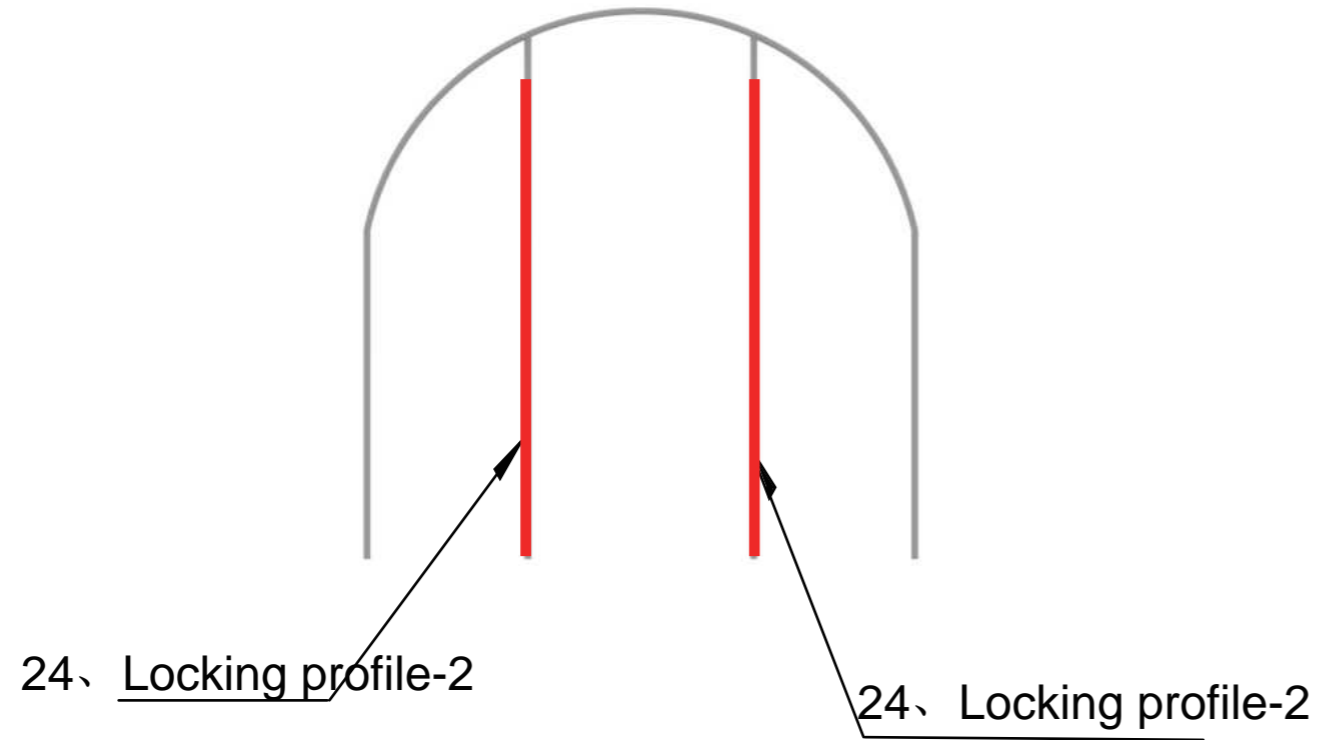

Front



PHOTO AS REFERENCE



Company	Qualimax LTD
Designer	LUCY
Auditor	LEO
Scale	1:1000
Date	2021/1/25



LIVING CULTURE

# .Installation of roof film

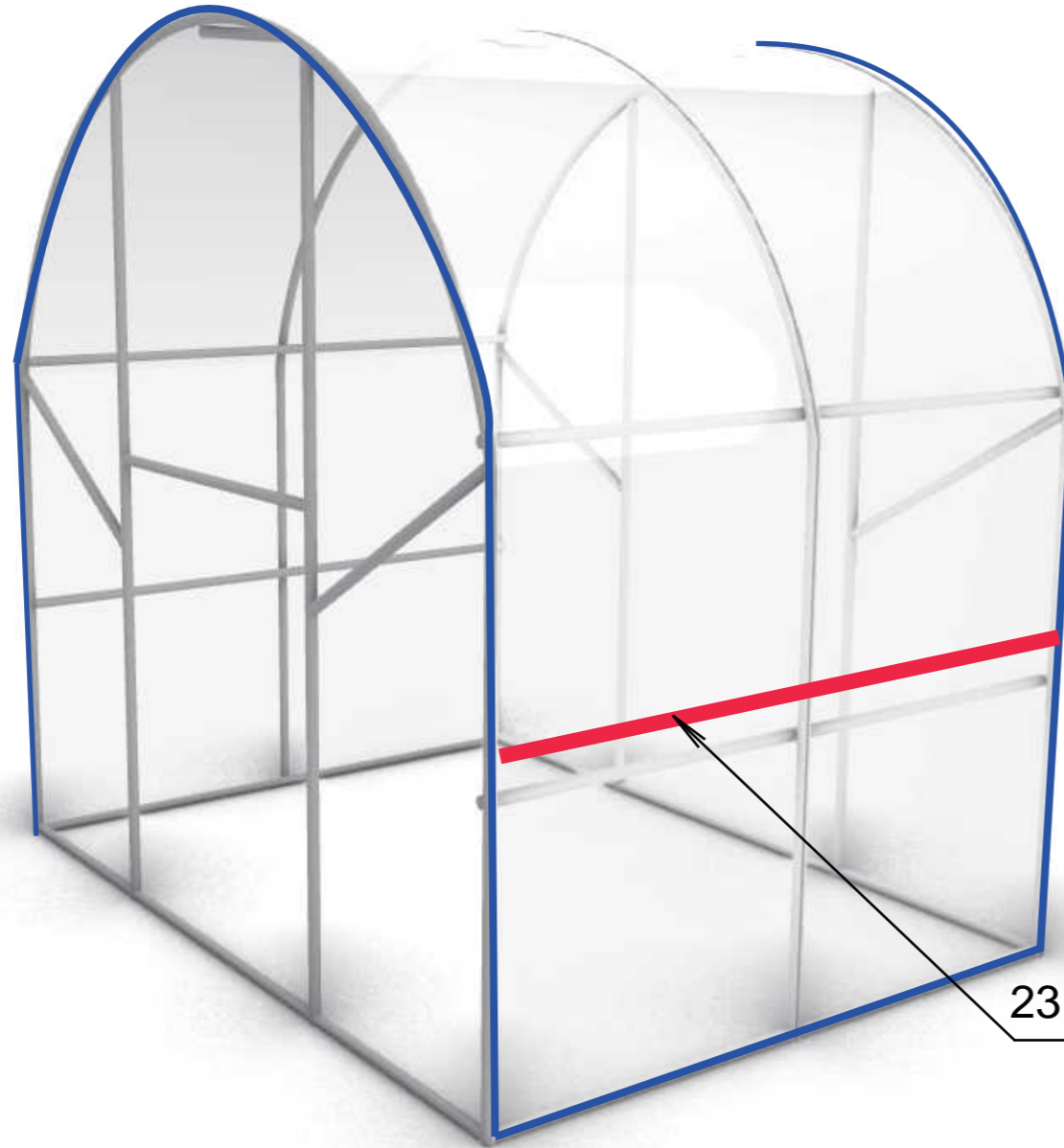

23. Locking Profile-1



DR

PHOTO AS REFERENCE

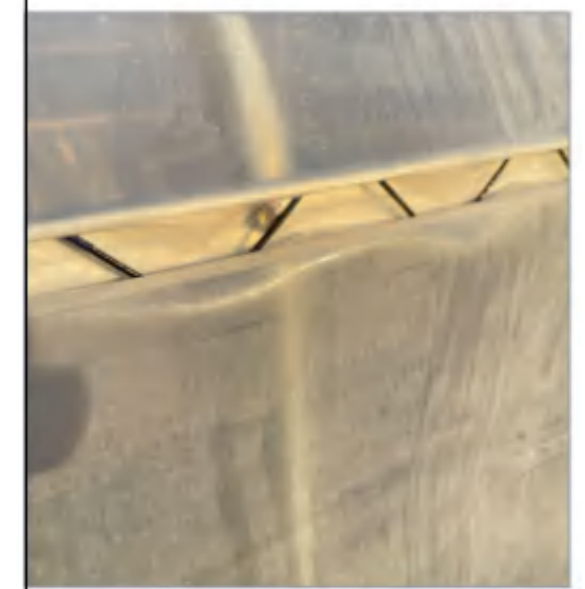

Use a clamp to snap the top membrane to the arches at both ends

Company	Qualimax LTD
Designer	LUCY
Auditor	LEO
Scale	1:1000
Date	2021/1/19



LIVING CULTURE

## 2. Installation of End Side Film

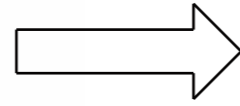
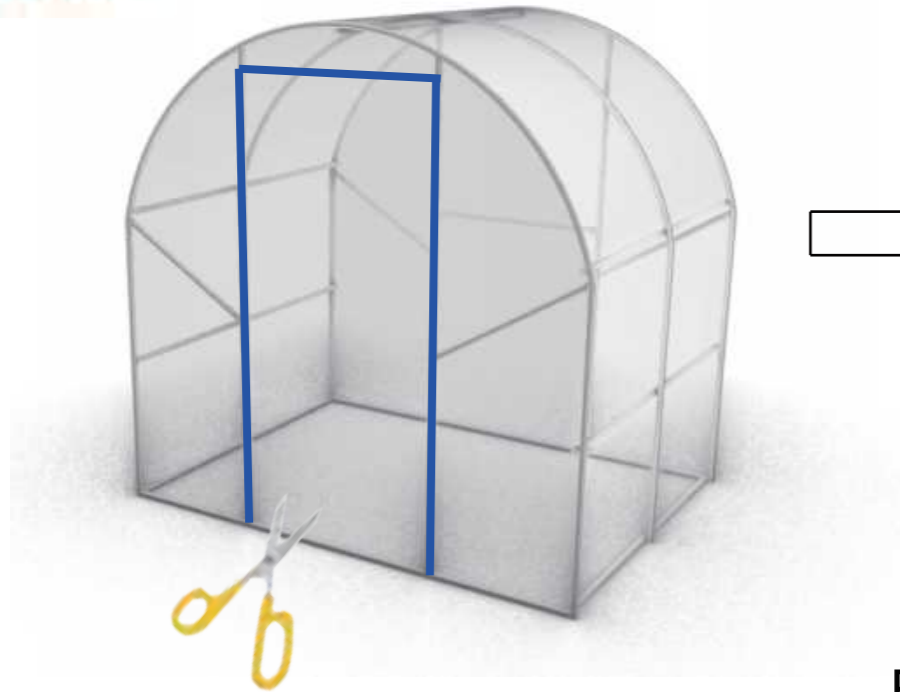

Front



Behind



PHOTO AS REFERENCE



Can be in the place of White Clamp

Company	Qualimax LTD
Designer	LUCY
Auditor	LEO
Scale	1:1000
Date	2021/1/25



### 3. Installation of door

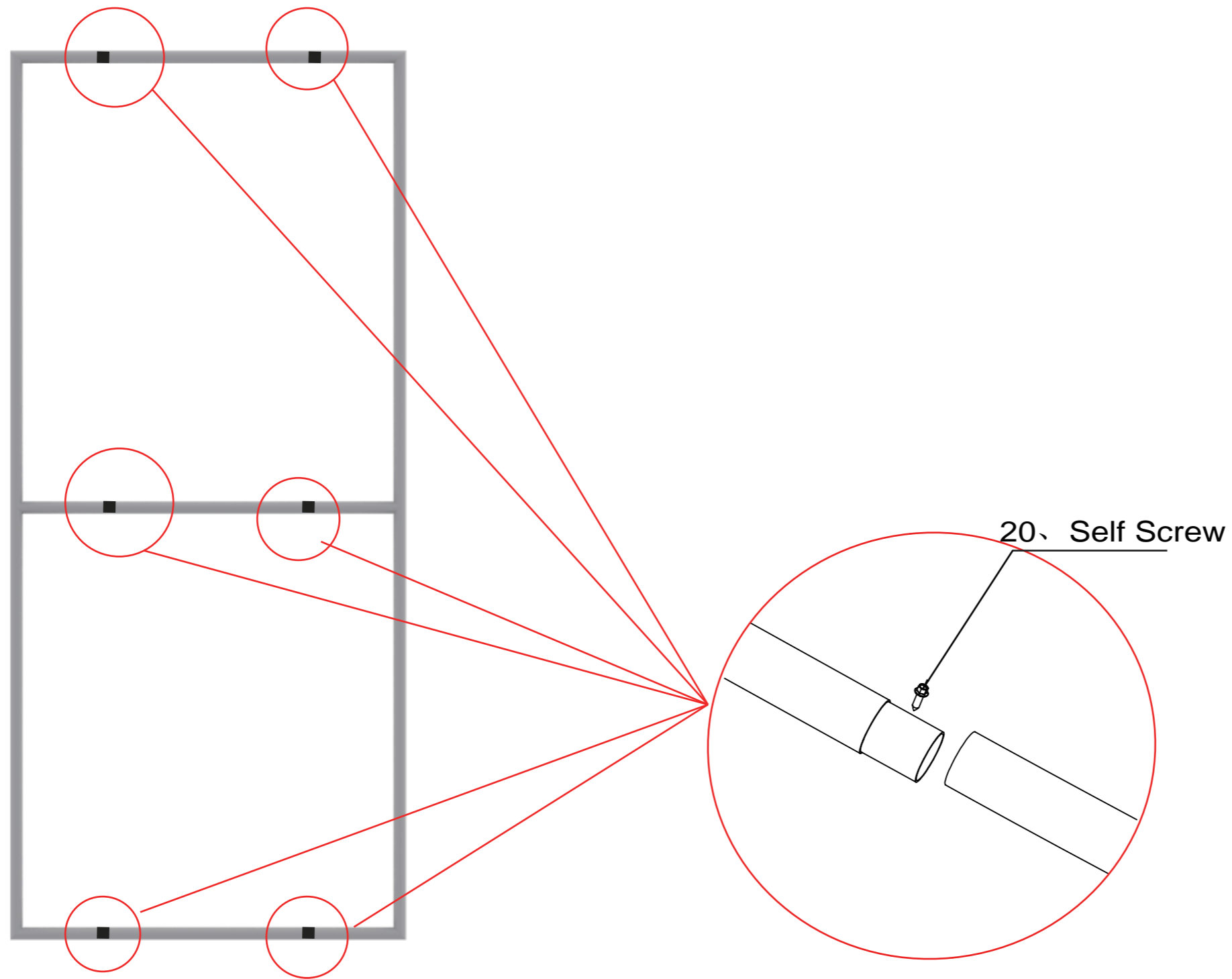

PHOTO AS REFERENCE



Company	Qualimax LTD
Designer	LUCY
Auditor	LEO
Scale	1:1000
Date	2021/1/25