

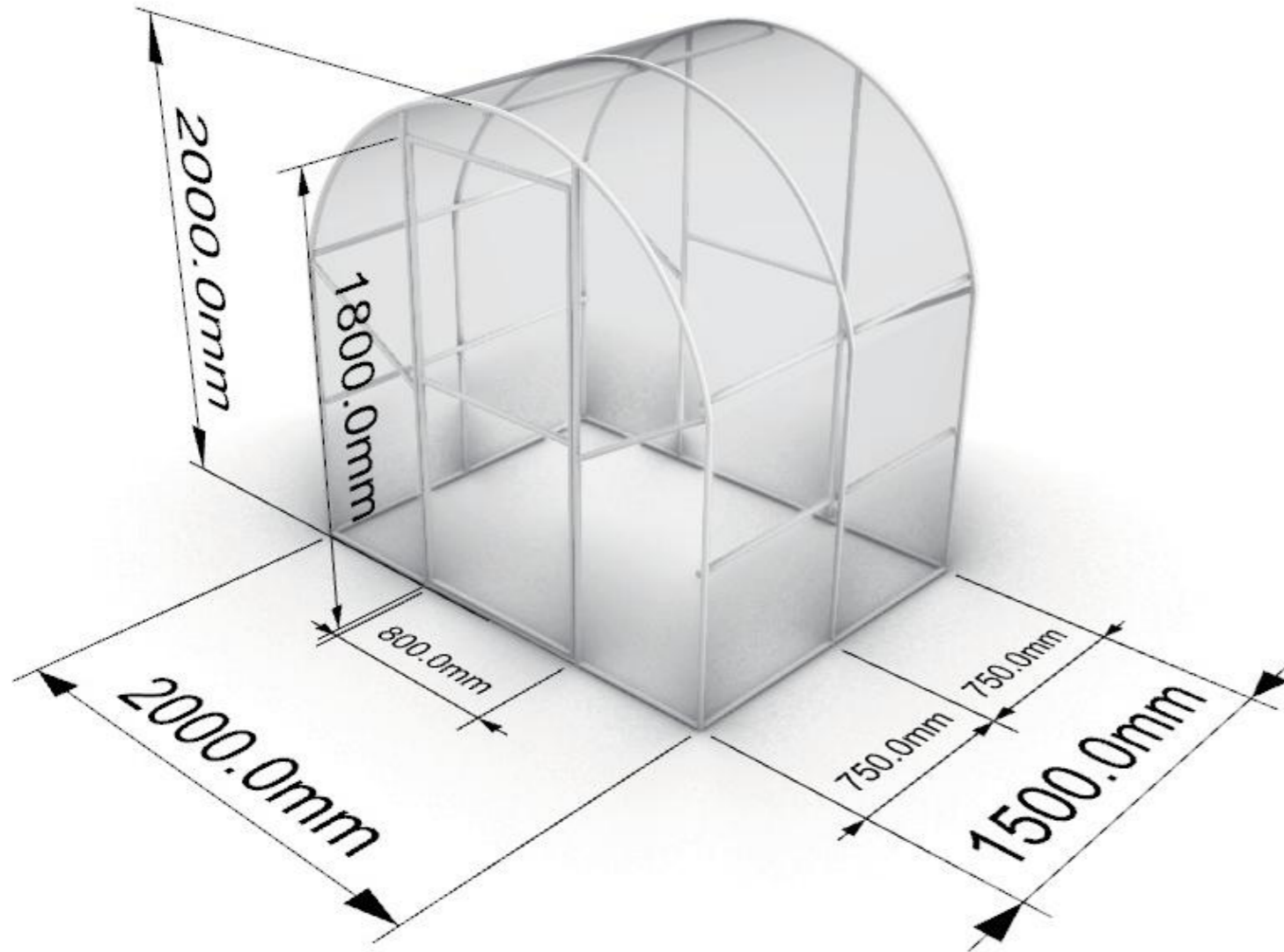

LIVING CULTURE



CS19035

Customer Name

Qualimax LTD

Length

1.5m

Width

2m

Wall Height

1.2m

Apex Height

2m

Arch Distance

0.75m



LIVING CULTURE

Greenhouse Pack you







Unpack



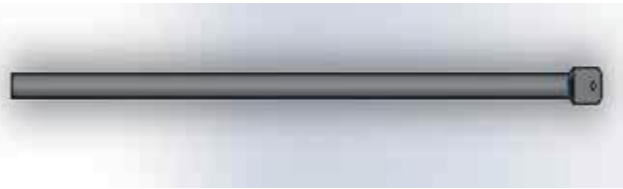

Material List for one set

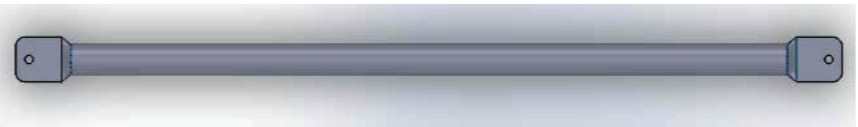
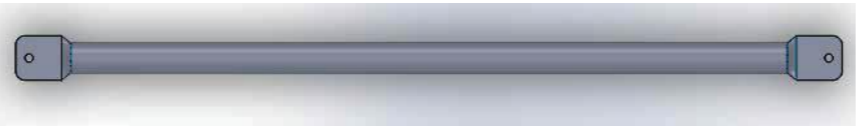
Item NO.	Commodity	Picture	Dimension	Length(m)	Quantity
1	Half arch-1		25*1.2mm	1.0m	3
2	Half arch-2		25*1.2mm	0.73m	6
3	Column		25*1.2mm	1.45m	6
4	End Post-1		25*1.2mm	1m	4
5	End Post-2		25*1.2mm	0.94m	4
6	End side horizontal bar-1		25*1.2mm	0.56m	4
7	End side horizontal bar-2		25*1.2mm	0.8m	1



Material List for one set









LIVING CULTURE

8	Purlin Pole		25*1.2mm	1.5m	5
9	Aluminum Basement -End-1		25*1.2mm	1.0m	2
10	Aluminum Basement -End-2		25*1.2mm	1.05m	2
11	Aluminum Basement -side		25*1.2mm	1.5m	2
12	Tube Clip		Φ25		120
13	Clamp 25		Φ25		40
14	Spring clip 25-25				5
15	Swing door		25*1.2mm	0.8m*1.8m	1



Material List for one set





LIVING CULTURE

16	Self Screw-1		5.5*20		60
17	Self Screw-2		5.5*40		6
18	Bolt Nut M6*30				40
19	Locking Profile-1		1.5m/pc	1.5m	2
20	Locking Profile-2		1.8m/pc	1.8m	4
21	Locking Profile-3		0.8m/pc	0.8m	4
22	Wire for locking profile		1.5m/pc	1.5m	2
23	Wire for locking profile		1.8m/pc	1.8m	4









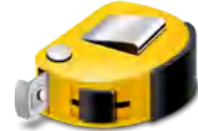

Material List for one set

LIVING CULTURE

24	Wire for locking profile		0.8m/pc	0.8m	4
25	Expansion Nuts and Screws		M6		8
26	Roof Film		150μm	10*15.5m	1
27	End Side Film		150μm	6.5*3.5m	2
28	Tube Clip	 Can be in the place of Black Clamp	Φ25		40
29	Basement Fixer				4
30					
31					



Tools (by yourself)

Spanner		Tape Measure	
Safety Gloves		Ladder	
Shovel			
Razor Knives			
Pliers			
Hammer		Drilling machine	
Power Drill			
Angle Grinder			

1. Installation of half arch ,the top of arch

PHOTO AS REFERENCE

Using self screw for connecting of half arch and the top of arch . see the picture.

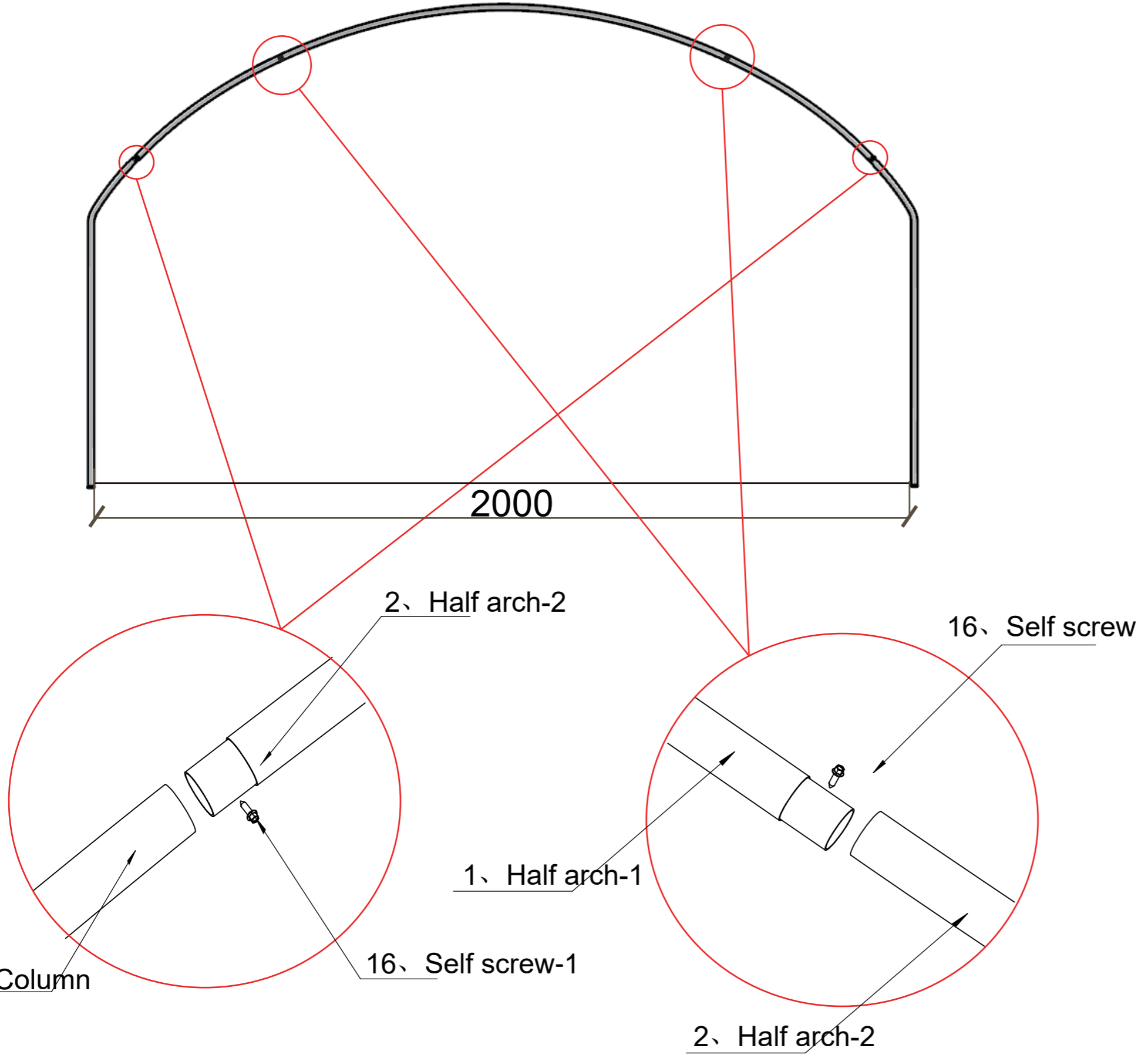

Company	Qualimax LTD
Designer	LUCY
Auditor	LEO
Scale	1:1000
Date	2021/1/25



LIVING CULTURE

2. Installation of head of purlin pole

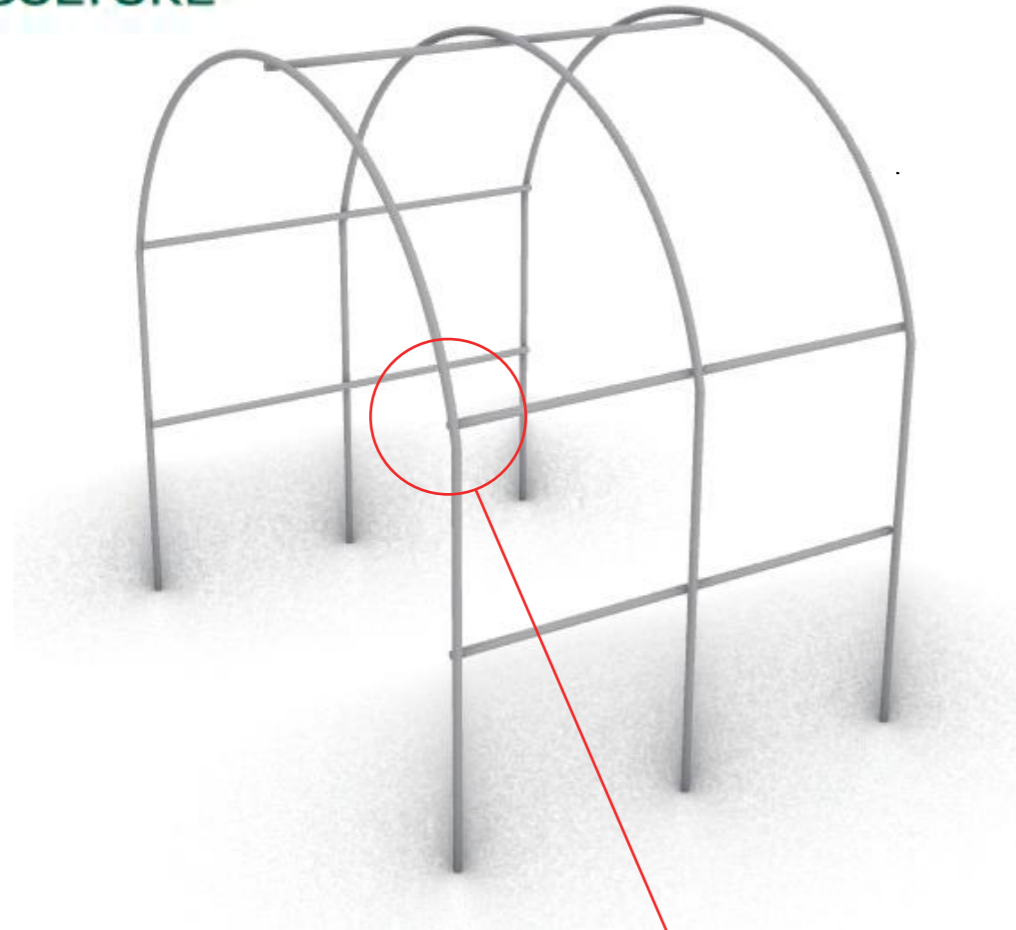

1、 Half arch

8、 Purlin Pole

18、 Bolt Nut M6

13、 Clamp 25

The head of purlin pole is connected to the arch by Clamp 25.

PHOTO AS REFERENCE



Company	Qualimax LTD
Designer	LUCY
Auditor	LEO
Scale	1:1000
Date	2021/1/25



3. Installation of Purlin Pole

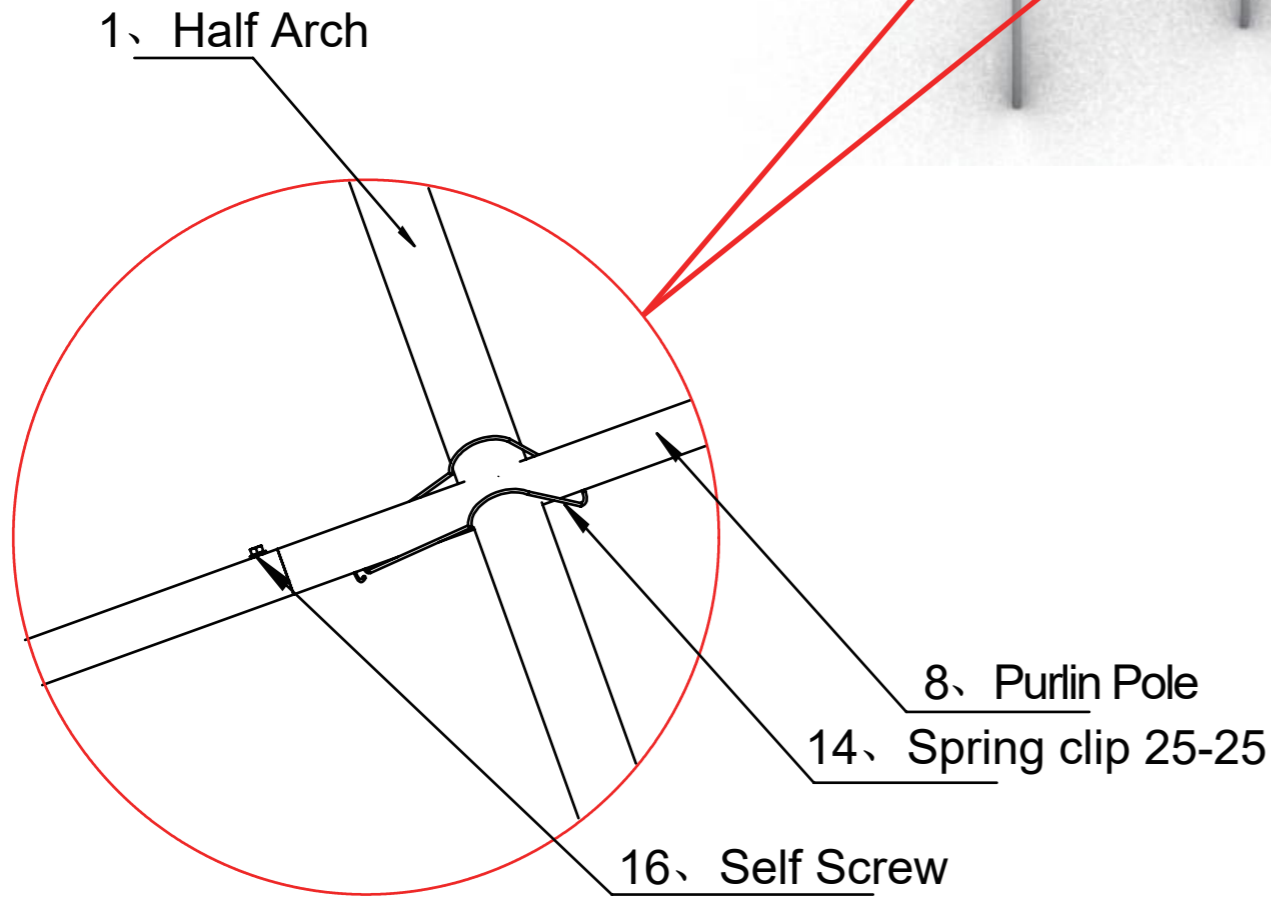
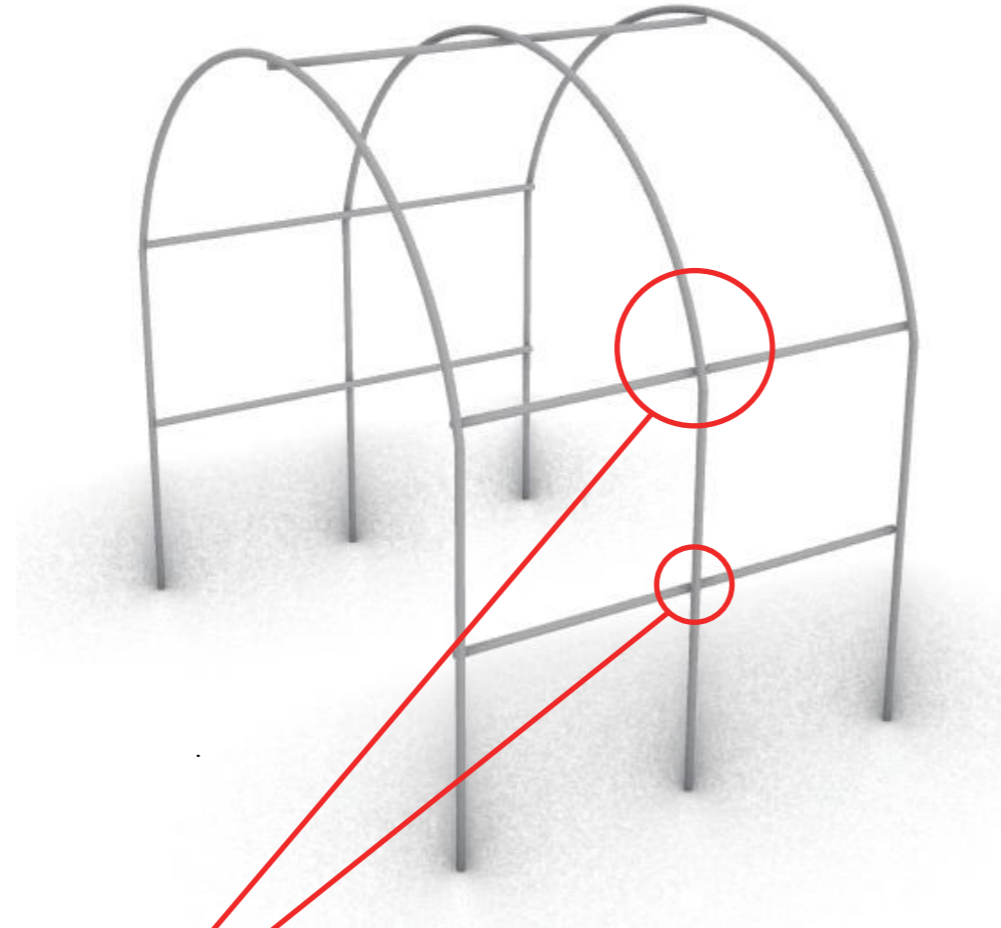

1. The purlin pole is connected to the arch by spring clip.

PHOTO AS REFERENCE



Company	Qualimax LTD
Designer	LUCY
Auditor	LEO
Scale	1:1000
Date	2021/1/25



LIVING CULTURE

4. Installation of end of purlin pole

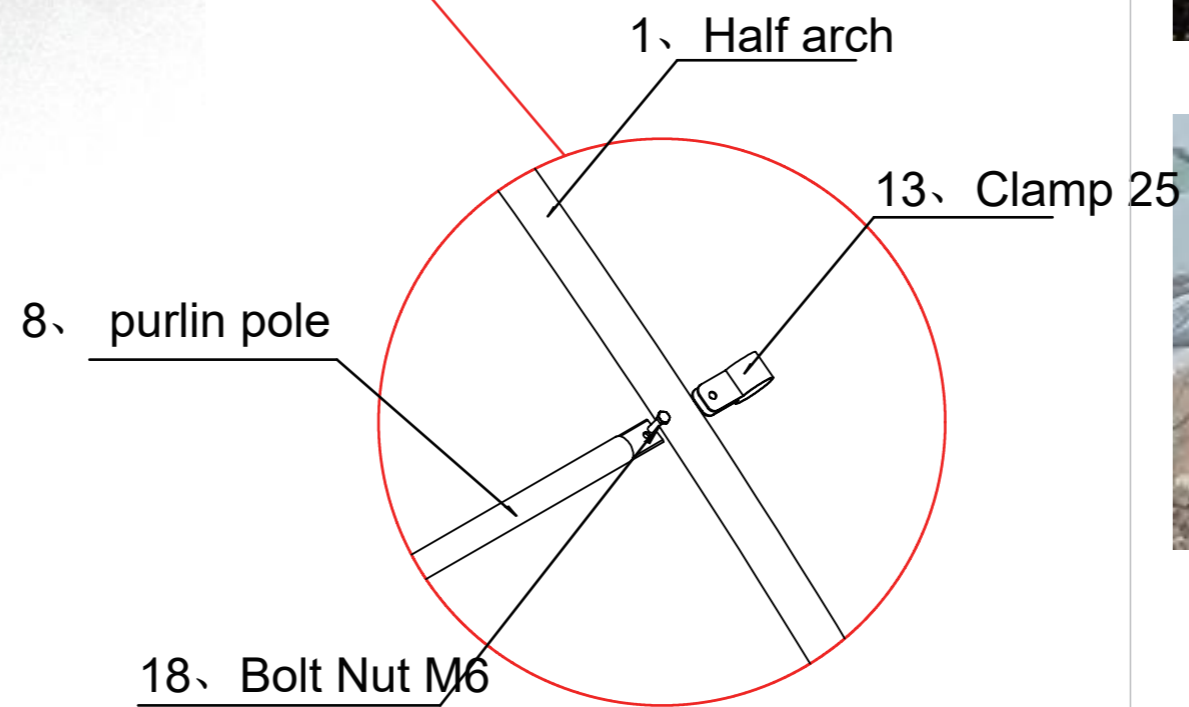
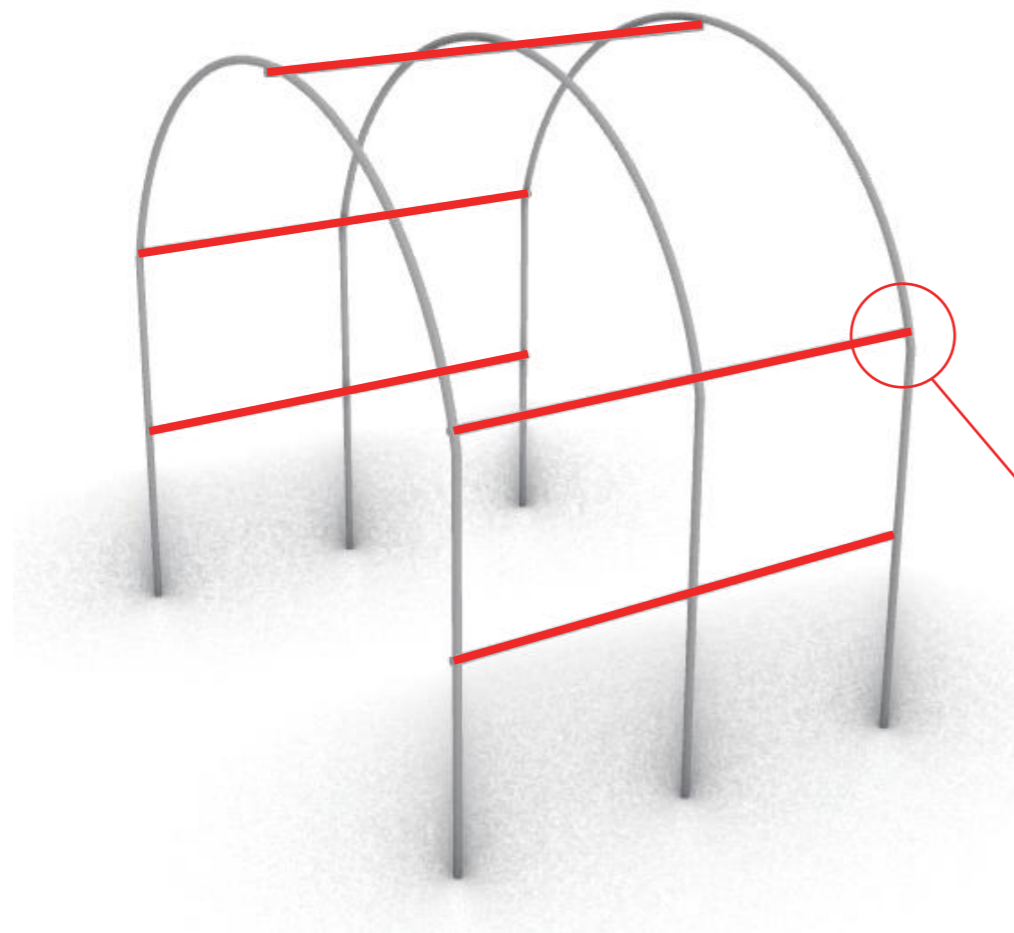

PHOTO AS REFERENCE



The end of purlin pole is connected to the last arch by clamp 25 and bolt nut M6.

Company	Qualimax LTD
Designer	LUCY
Auditor	LEO
Scale	1:1000
Date	2021/1/25

5. Installation of End Post

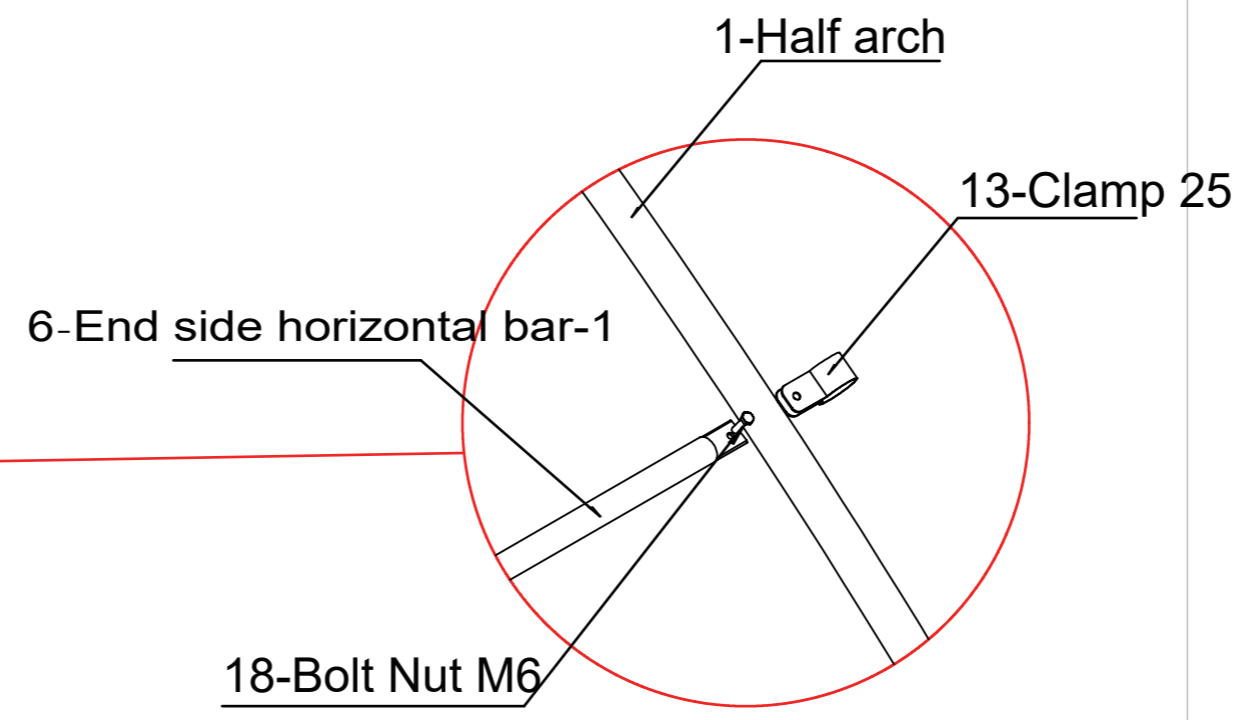
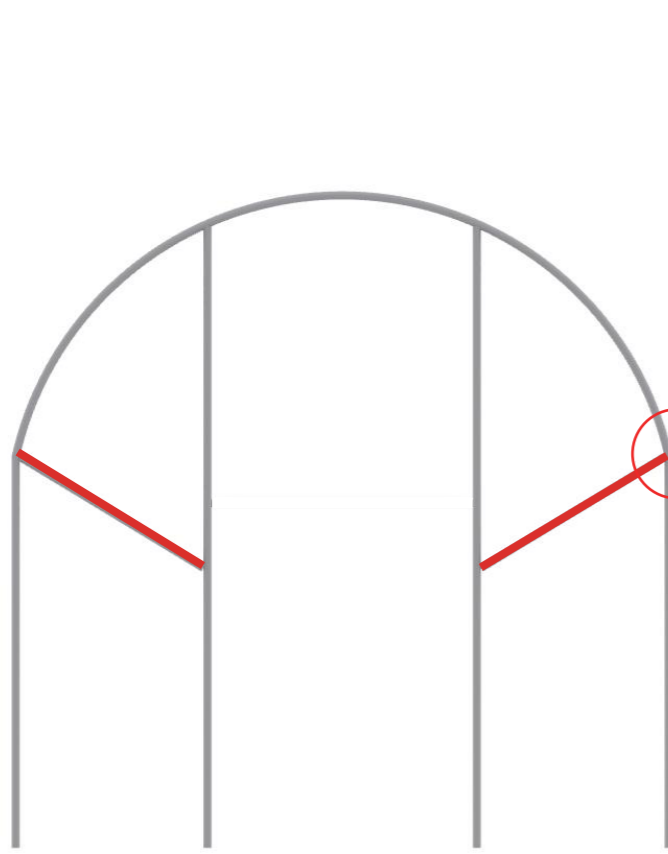
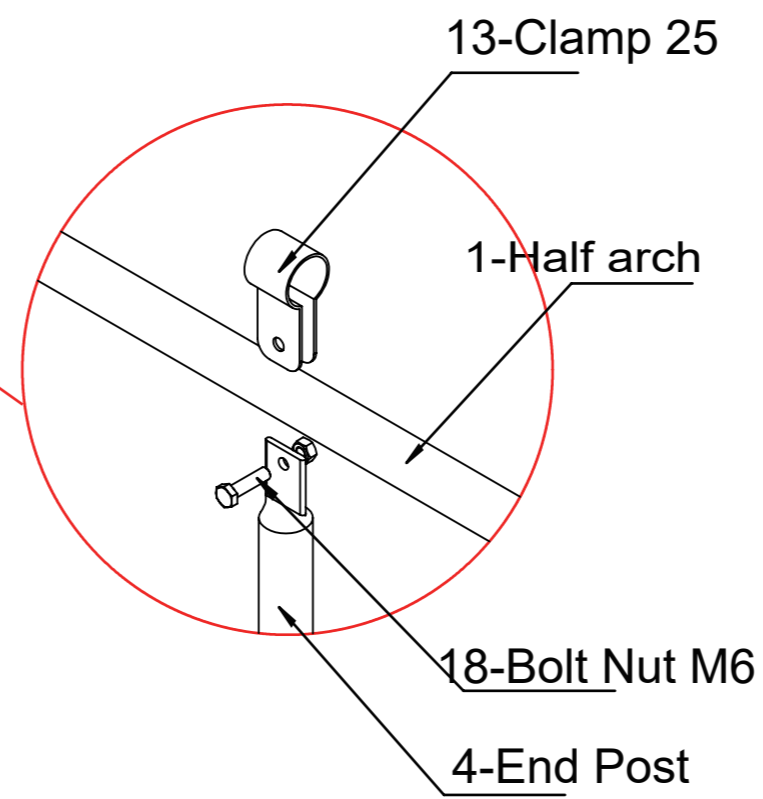
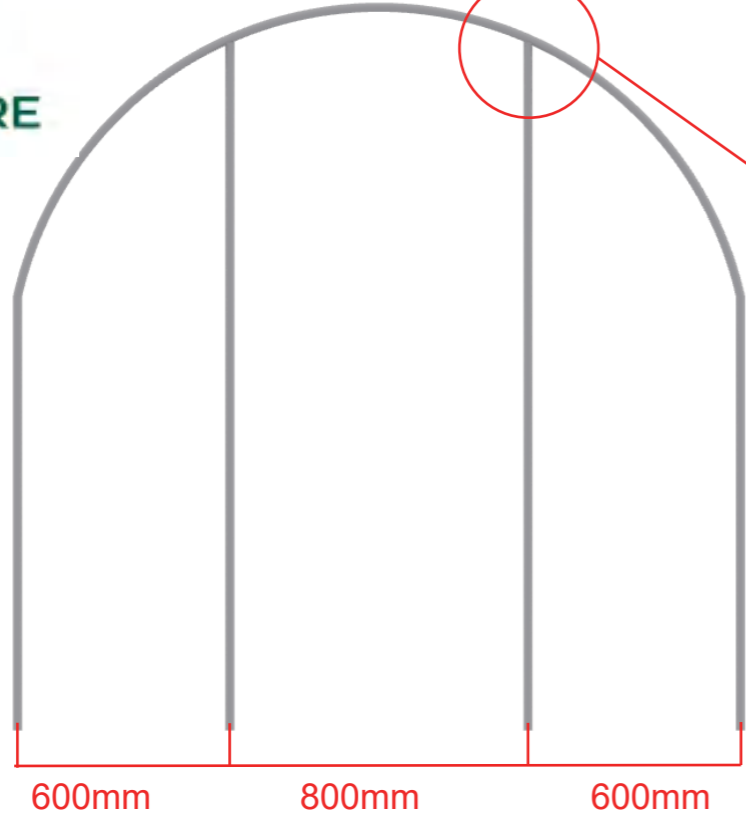
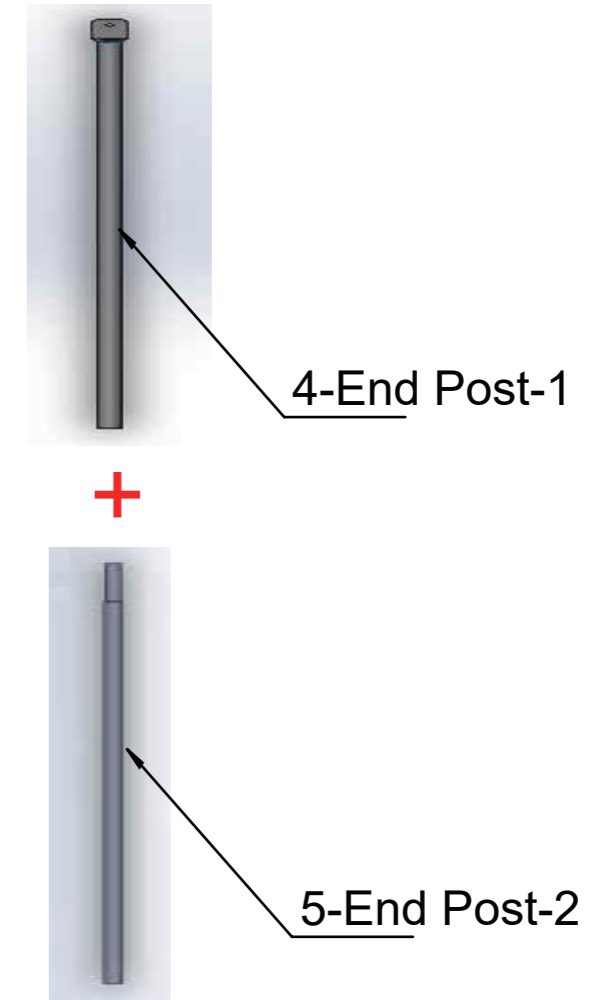

PHOTO AS REFERENCE



Using clamp 25 and bolt nut when connecting half arch and end post.

Company	Qualimax LTD
Designer	LUCY
Auditor	LEO
Scale	1:1000
Date	2021/1/25

6. Installation of End Post (Without door)

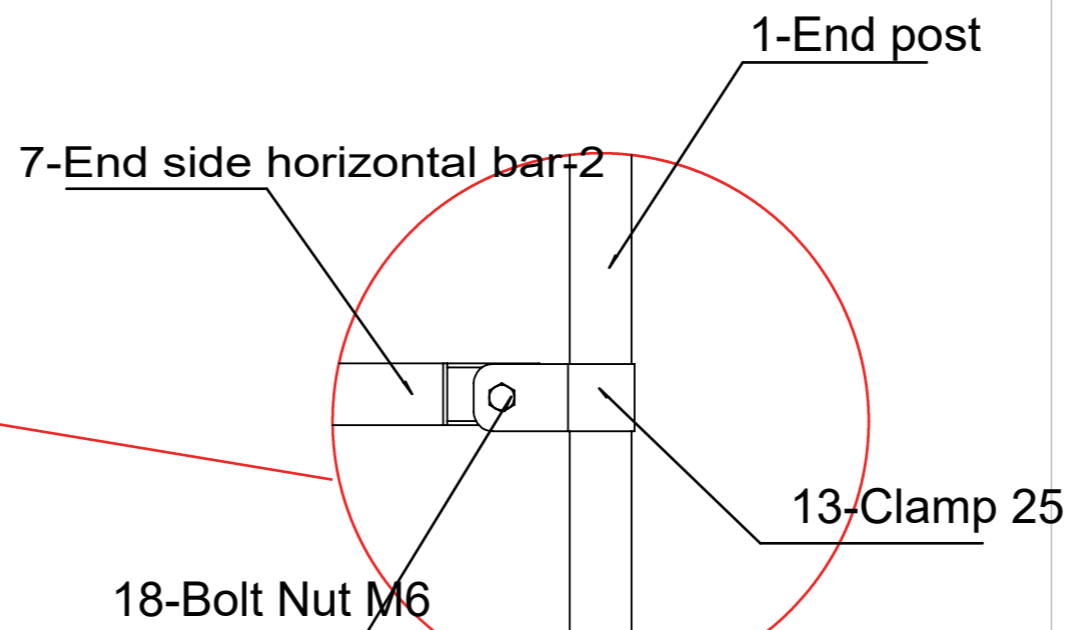
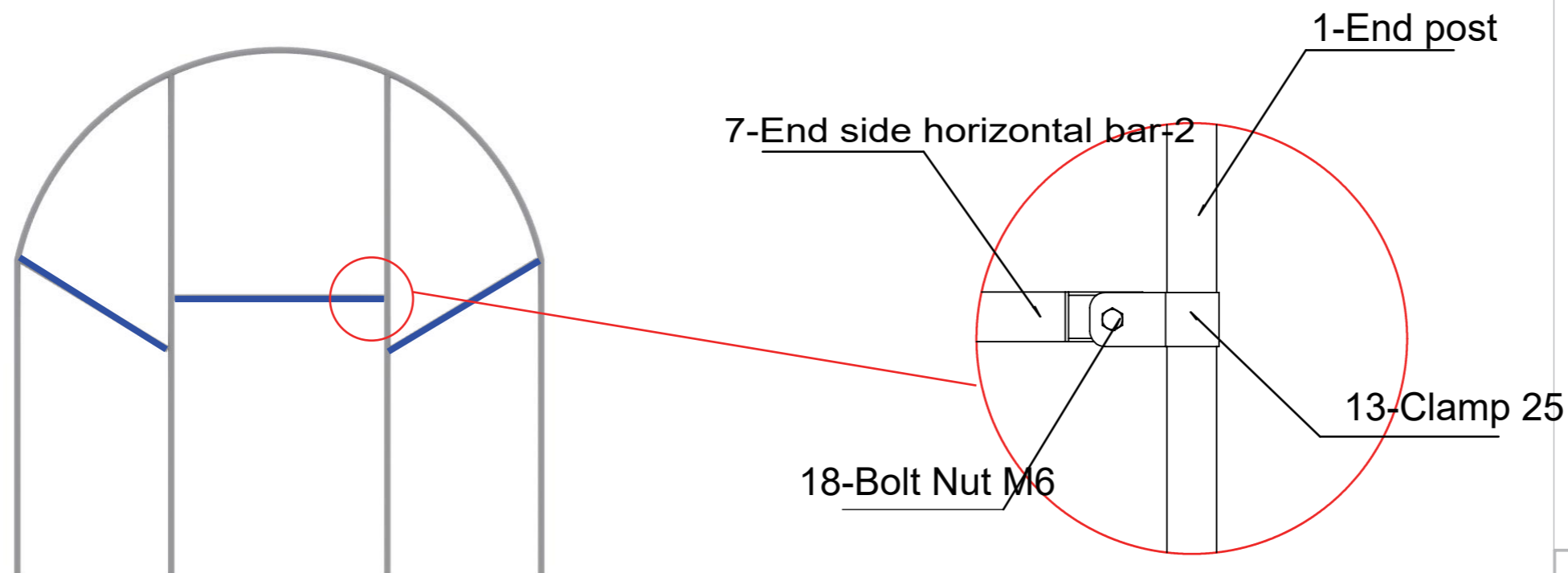
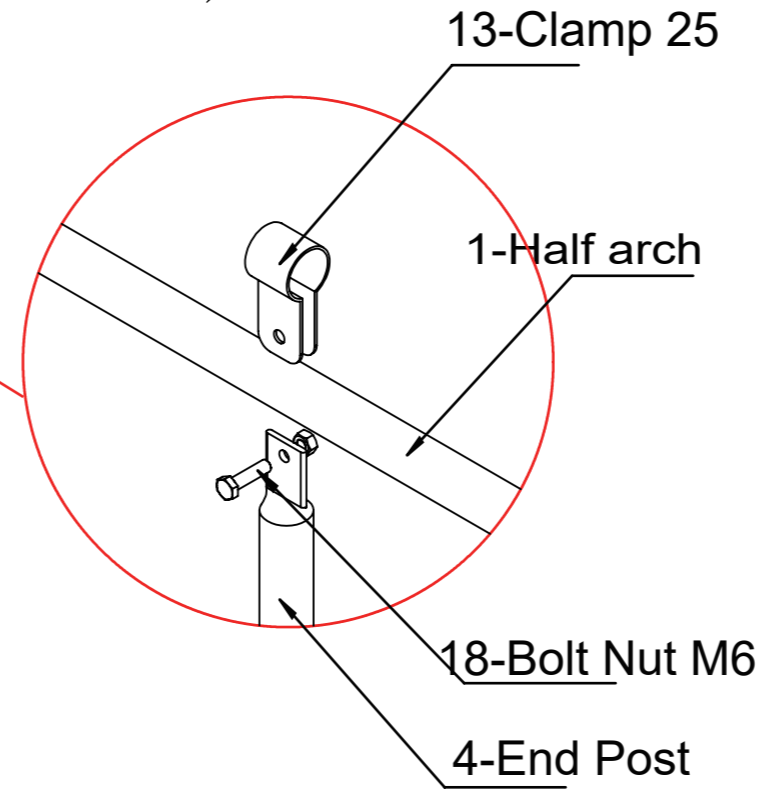
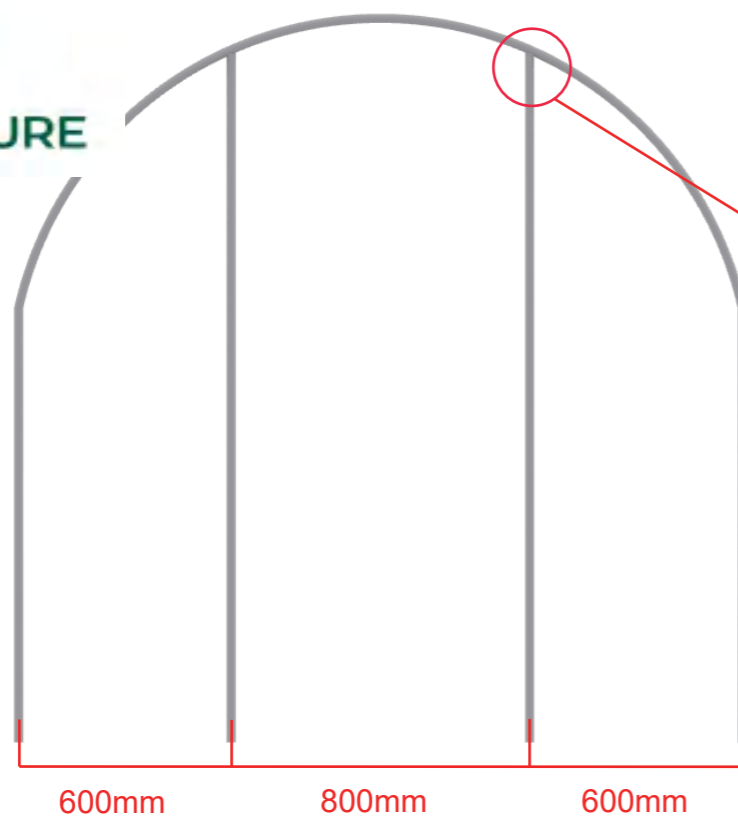
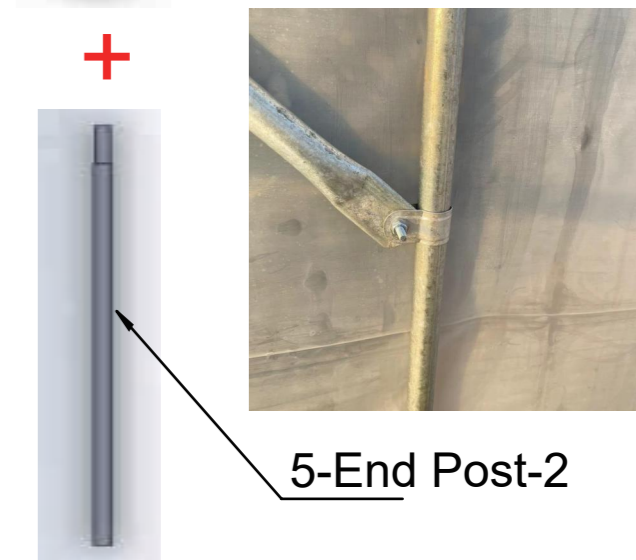
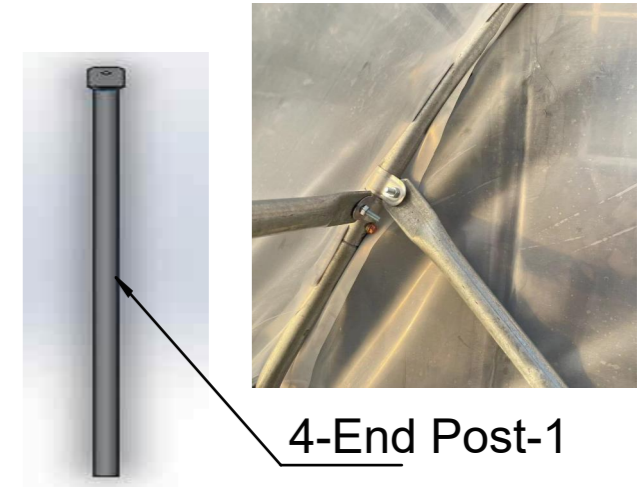
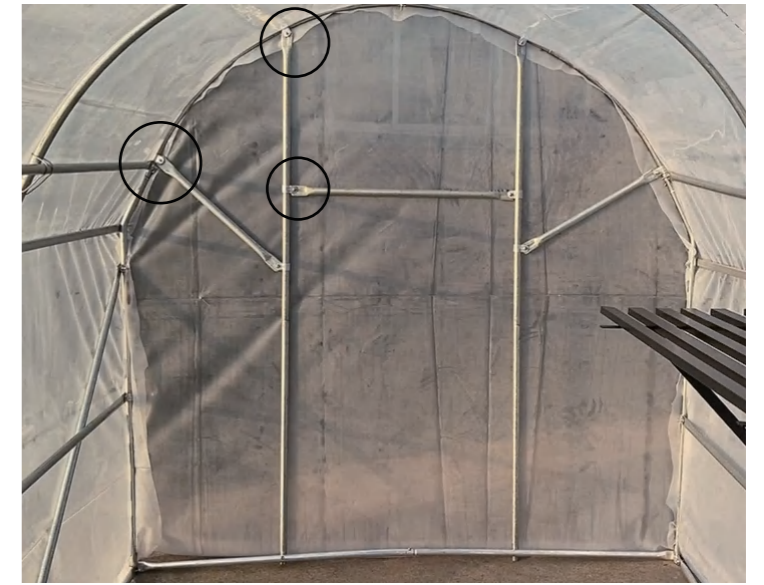
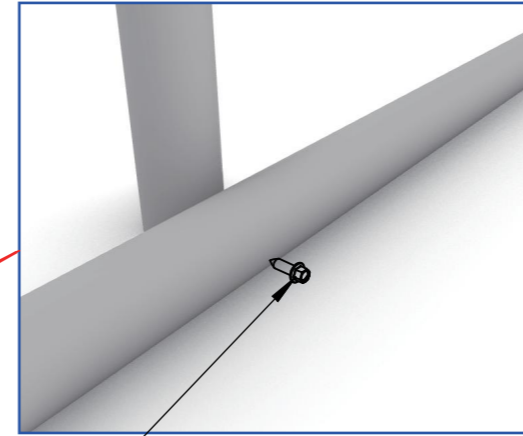
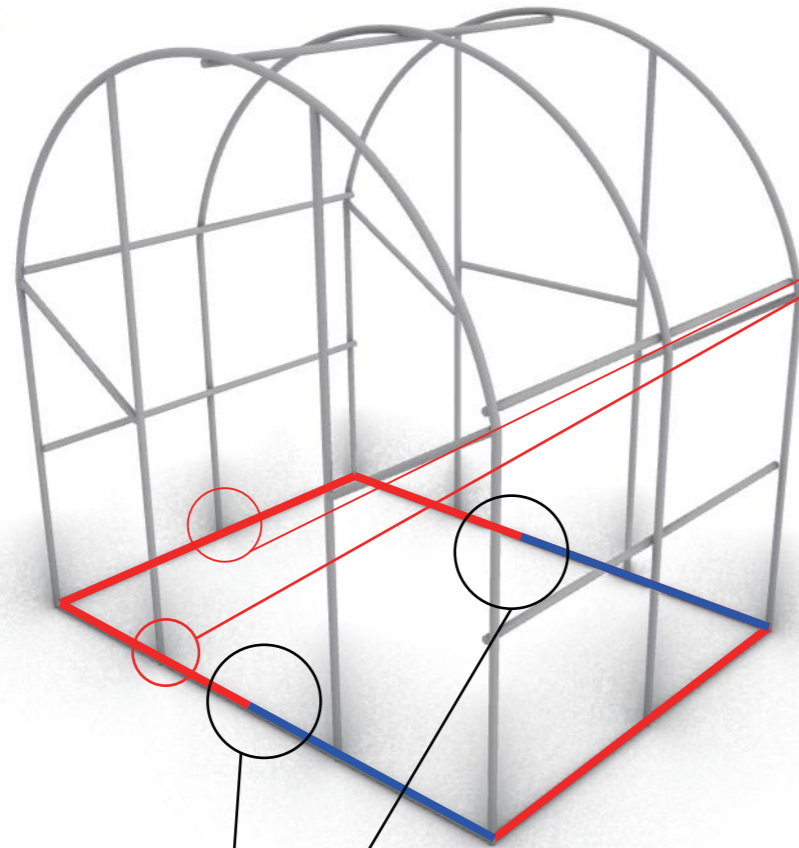

PHOTO AS REFERENCE



Company	Qualimax LTD
Designer	LUCY
Auditor	LEO
Scale	1:1000
Date	2021/1/25

7. Install the bottom frame



17、 Self Screw



16、 Self Screw

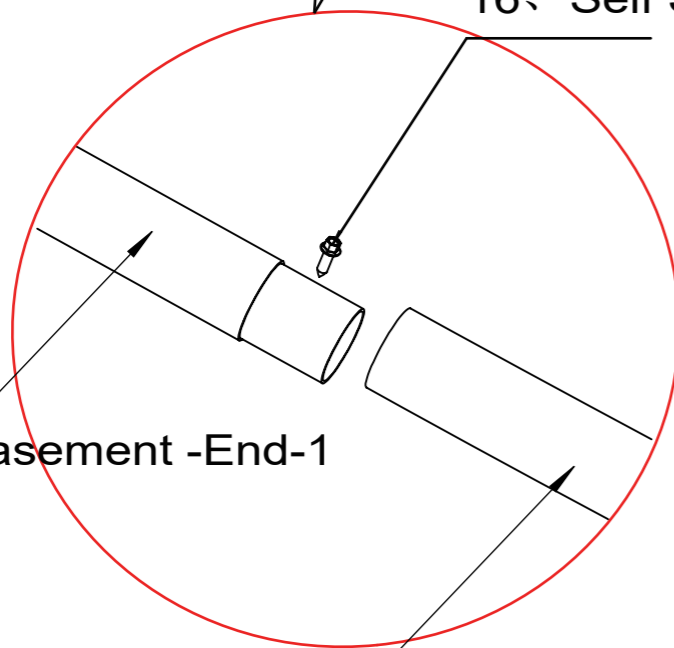

9、 Aluminum Basement -End-1

10、 Aluminum Basement -End-2

PHOTO AS REFERENCE



Company

Qualimax LTD

Designer

LUCY

Auditor

LEO

Scale

1:1000

Date

2021/1/25

8. Installation of locking profile

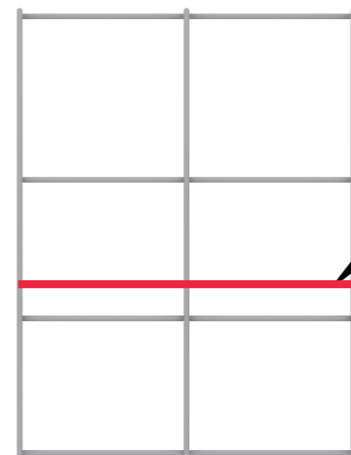
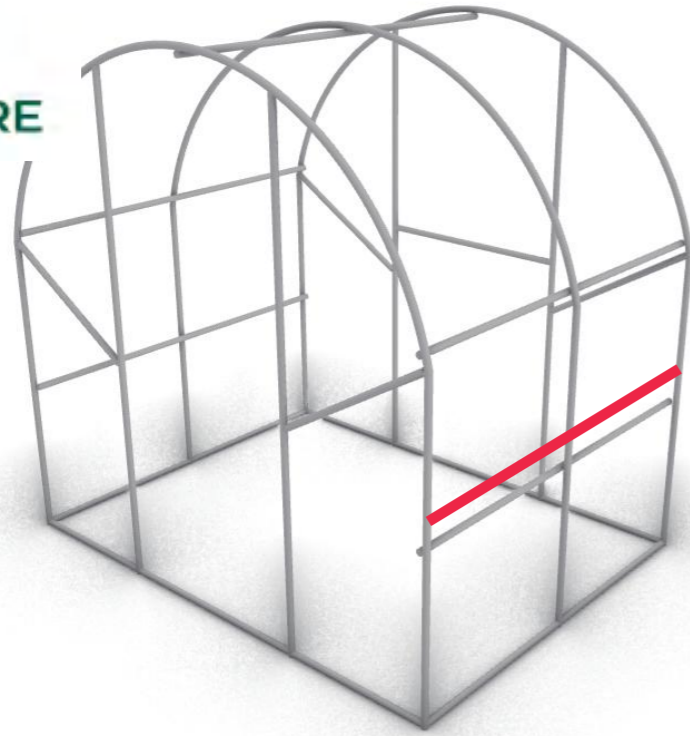

19. Locking Profile-1

PHOTO AS REFERENCE



Company	Qualimax LTD
Designer	LUCY
Auditor	LEO
Scale	1:1000
Date	2021/1/25



LIVING CULTURE

9. Installation of locking profile for end side

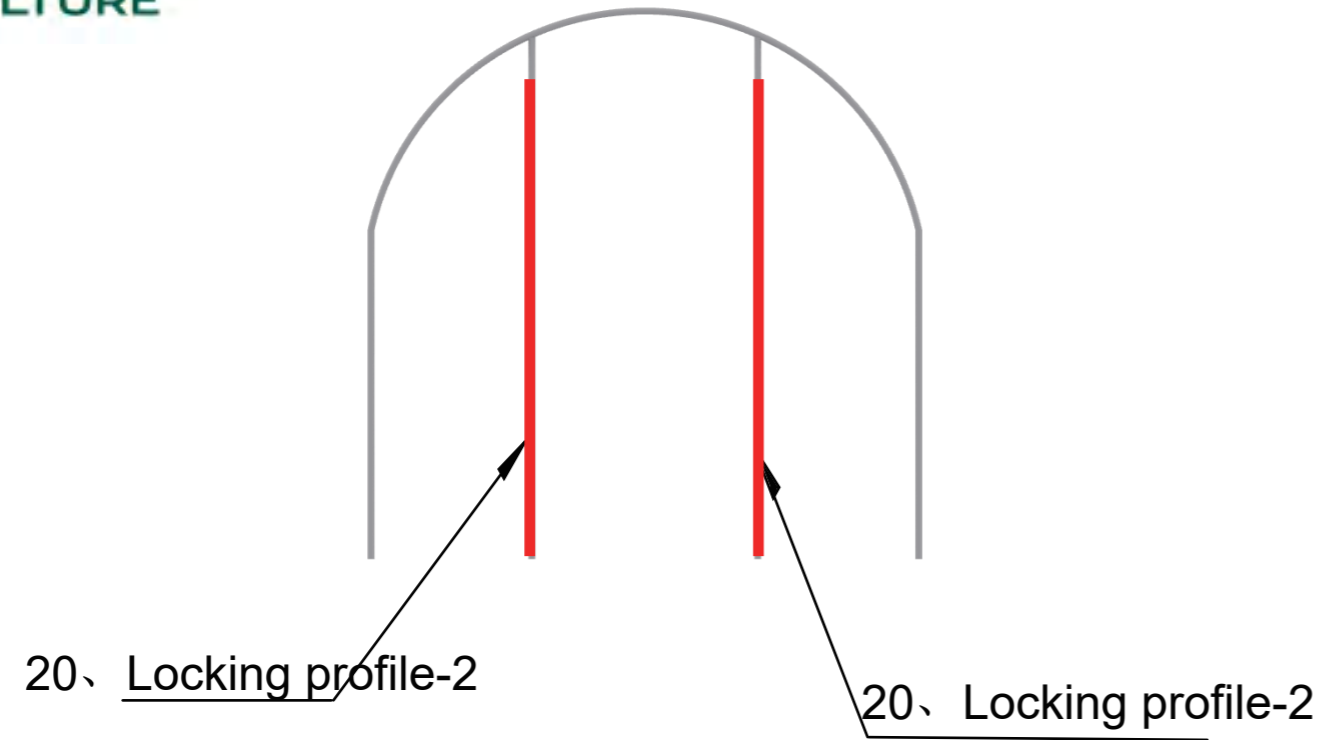

Front



PHOTO AS REFERENCE



Company	Qualimax LTD
Designer	LUCY
Auditor	LEO
Scale	1:1000
Date	2021/1/25

10. Installation of roof film

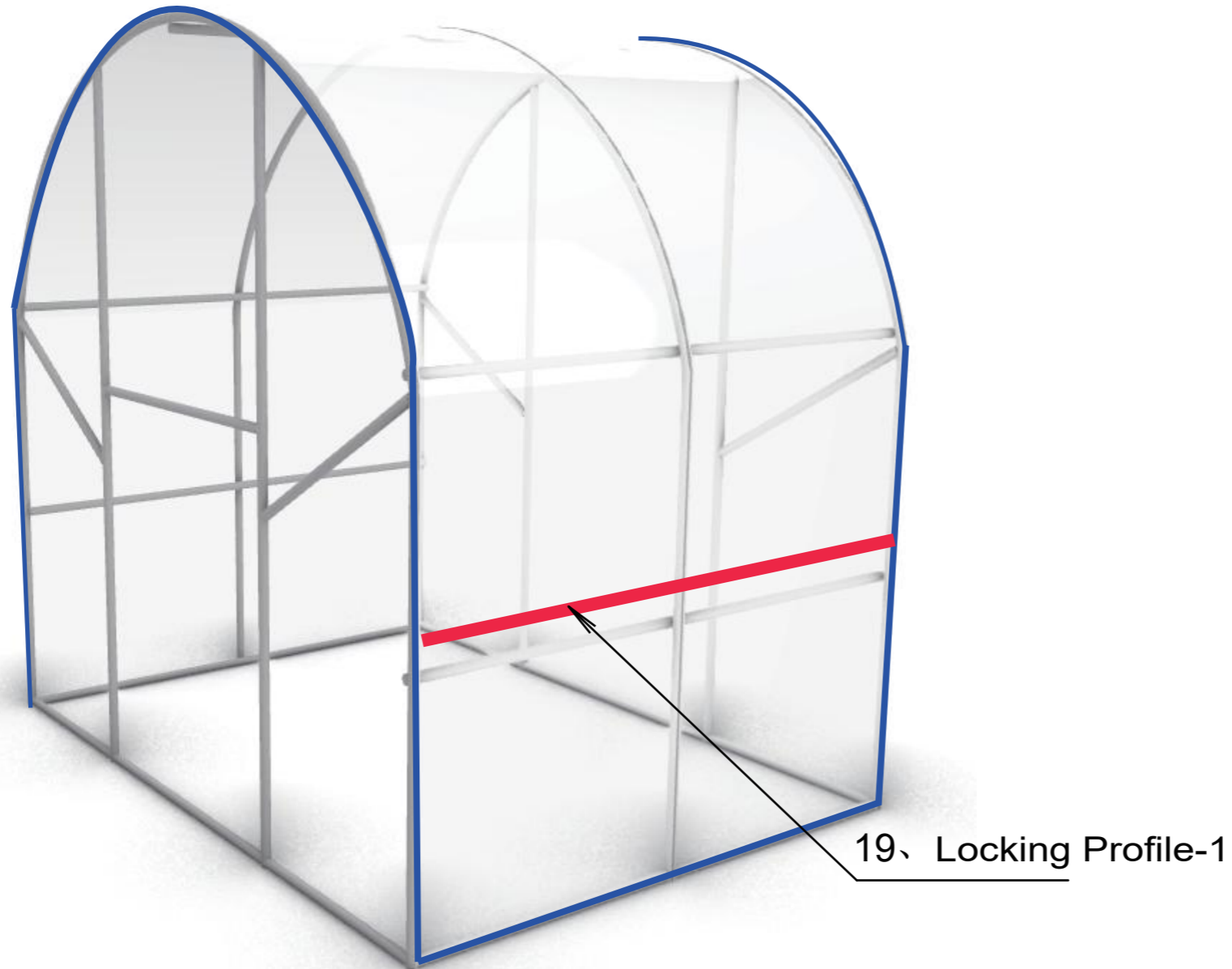

PHOTO AS REFERENCE



Use a clamp to snap the top membrane to the arches at both ends

Company	Qualimax LTD
Designer	LUCY
Auditor	LEO
Scale	1:1000
Date	2021/1/19



LIVING CULTURE

11. Installation of End Side Film

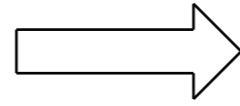
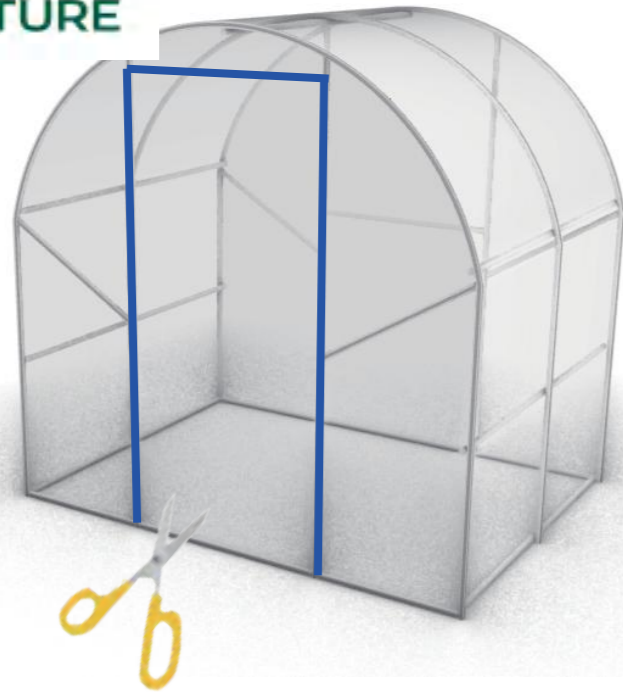

Front



Behind



PHOTO AS REFERENCE



Company	Qualimax LTD
Designer	LUCY
Auditor	LEO
Scale	1:1000
Date	2021/1/25



21. Installation of door

LIVING CULTURE

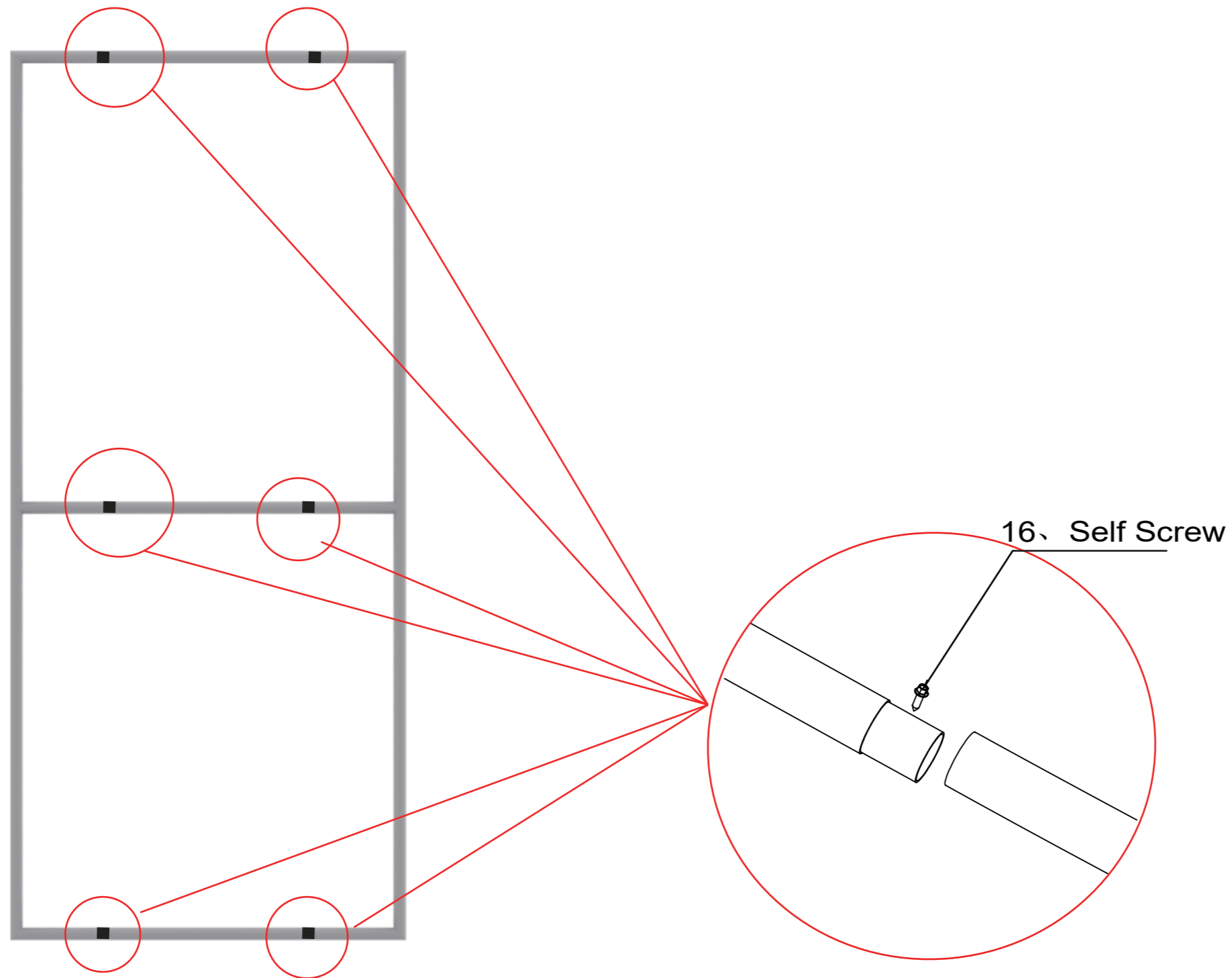

PHOTO AS REFERENCE



Company	Qualimax LTD
Designer	LUCY
Auditor	LEO
Scale	1:1000
Date	2021/1/25