

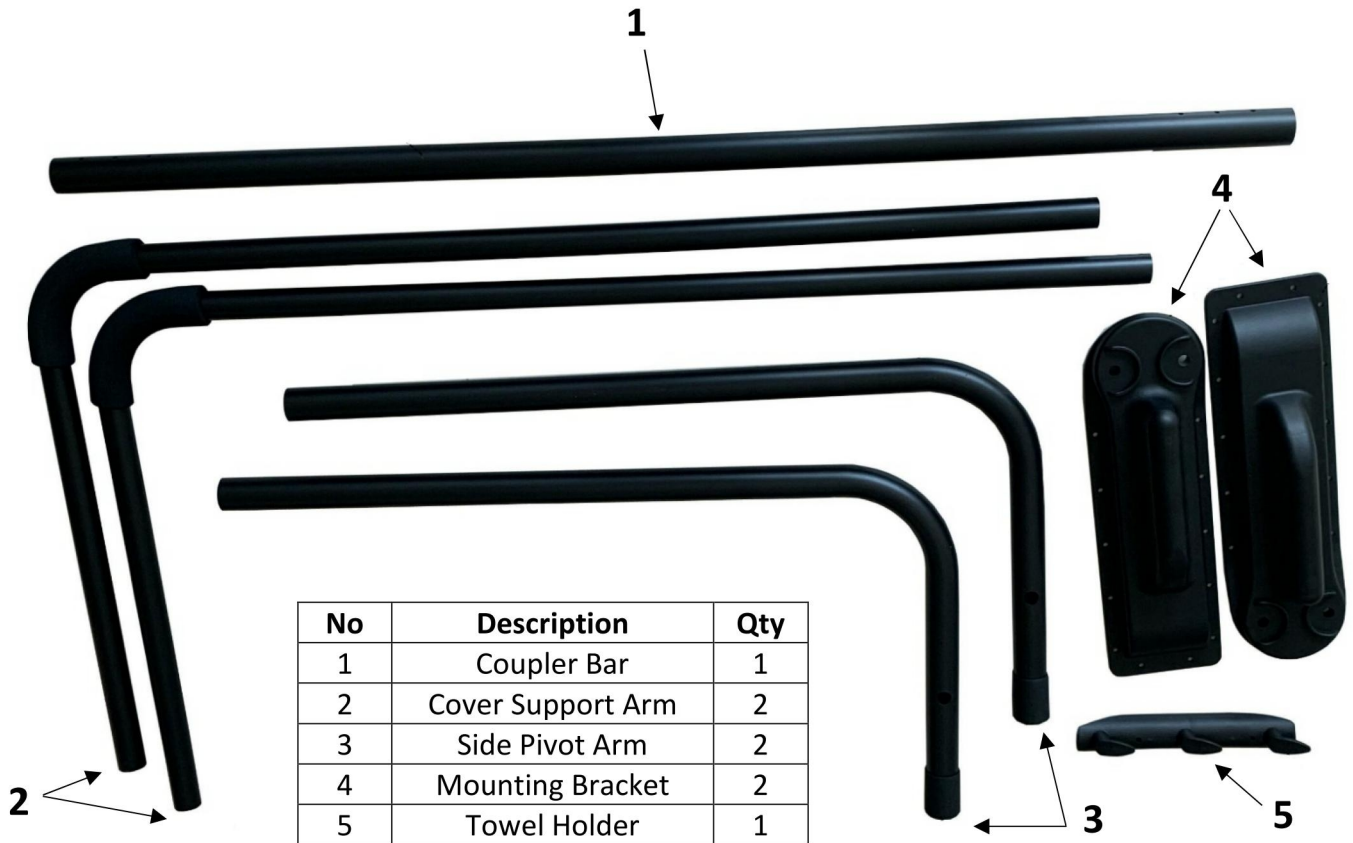











# COVER ASSIST iii INSTALLATION INSTRUCTIONS

## PARTS LIST



## FITTINGS

Picture	Description	Qty	Picture	Description	Qty
	Bushes	4		Bolt Caps	2
	Long Screws	24		Bolt	2
	Screw Caps	36		Screwdriver Bit	1
	Lock Nut	2		Washer	4
	Short Screw	12		Drill Bit	1
	Small plug (for unoccupied holes of Bushes)	2			

# DIAGRAM

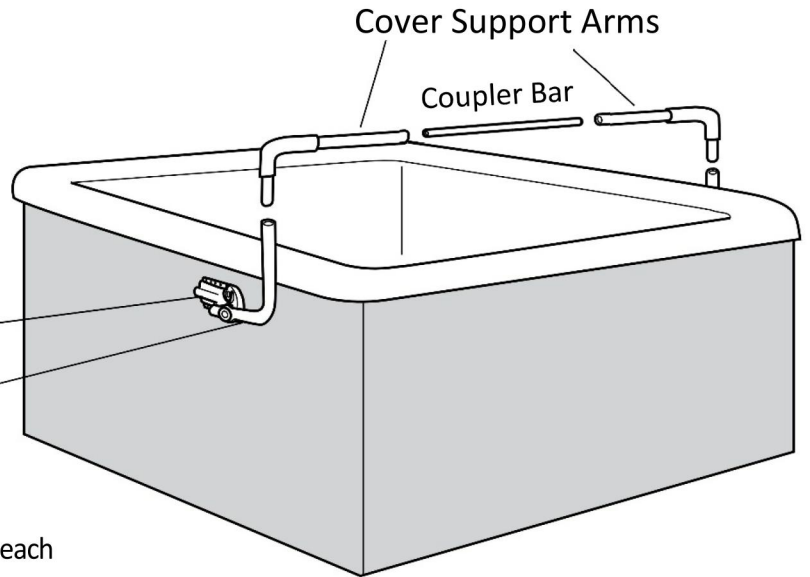

## TO ASSEMBLE & INSTALL

1. Attach the right and left Mounting Brackets to the appropriate sides of the spa using 12 Long Screws on each side.

CAUTION: to prevent splitting of the wood cabinet, predrill the holes with the provided drill bit.

Mounting height is optional.

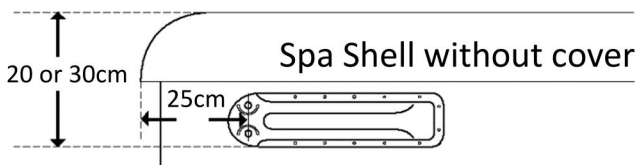

Adjust the mounting position according to cover length/width, cover thickness and spa corner radius.

By positioning the Mounting Brackets 20cm from the top of the spa shell, approximately 25cm clearance behind the spa will be needed. Mounted at this position, approx. 75% of the spa cover will be standing above the spa surface in the off position. By positioning the Mounting Brackets 30cm from the top of the spa shell, approx. 35cm clearance behind the spa will be needed. Mounted at this position, approx. 50% of the spa cover will be standing above the spa surface in the off position.

2. Connect the Side Pivot Arms to the Mounting Brackets, using the Bushes, Bolts, Washers and Lock Nuts.

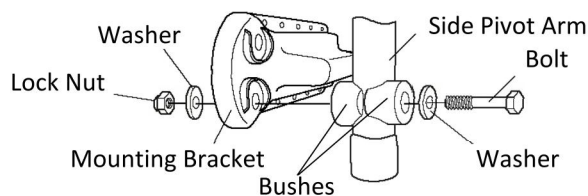

After the Side Pivot Arms are connected, tilt them back to the upright position.

3. Position the spa cover (in closed position) on the spa, making sure that all four corners are properly positioned and square on the spa.

4. Attach the Coupler Bar using the Short Screws. Insert the Coupler Bar into the Cover Support Arms. Slide the short Cover Support Arms into the Side Pivot Arms.

5. Lay the Cover Lifter on the spa cover. Adjust the Coupler Bar and Support Arms so that the Coupler Bars are in parallel to the spa cover hinge and about 2cm away.

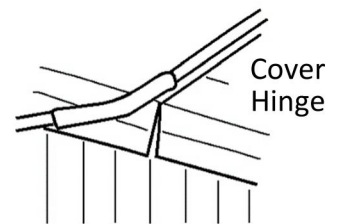

6. Using the Short Screws, fasten the Cover Support Arms to the Side Pivot Arms and the Coupler Bar. Be sure to rotate the Coupler Bar so that the inserted screws are at a horizontal angle with heads facing the back of the spa, otherwise there may be damage to cover surface.

7. Attach the provided 3-hook Towel Holder on the preferred side of your Cover Lifter by simply snapping it into place and inserting the Short Screws.

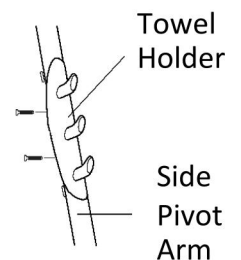

8. Cover any visible screws with Screw Caps, and fit the Bolt Caps.

**CAUTION:** Do not use this cover lifter in high winds (greater than 10 mph). Risk that injury or damage to the spa could occur if the cover is blown over.