

PART LIST 1

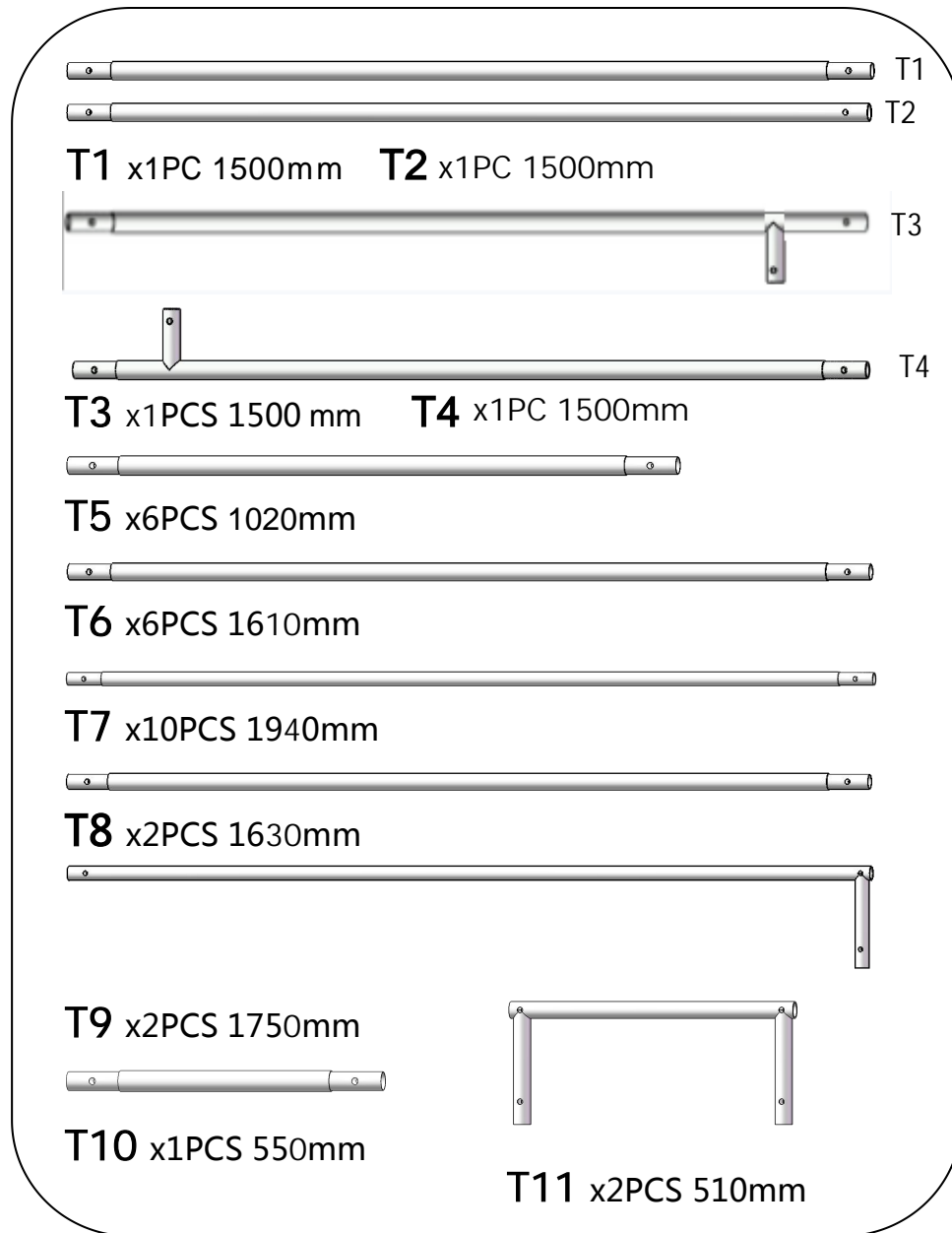

PART LIST 2

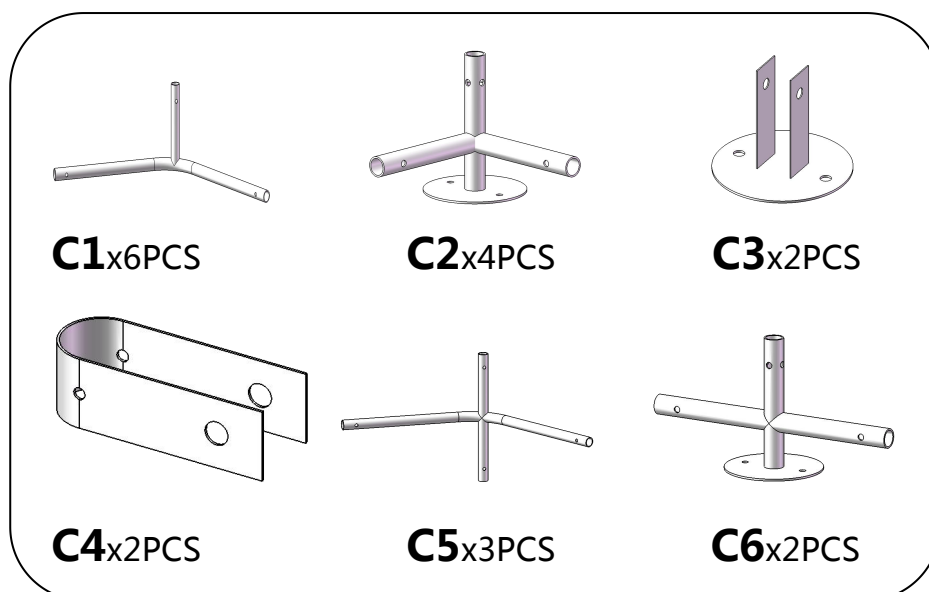

PART LIST 3

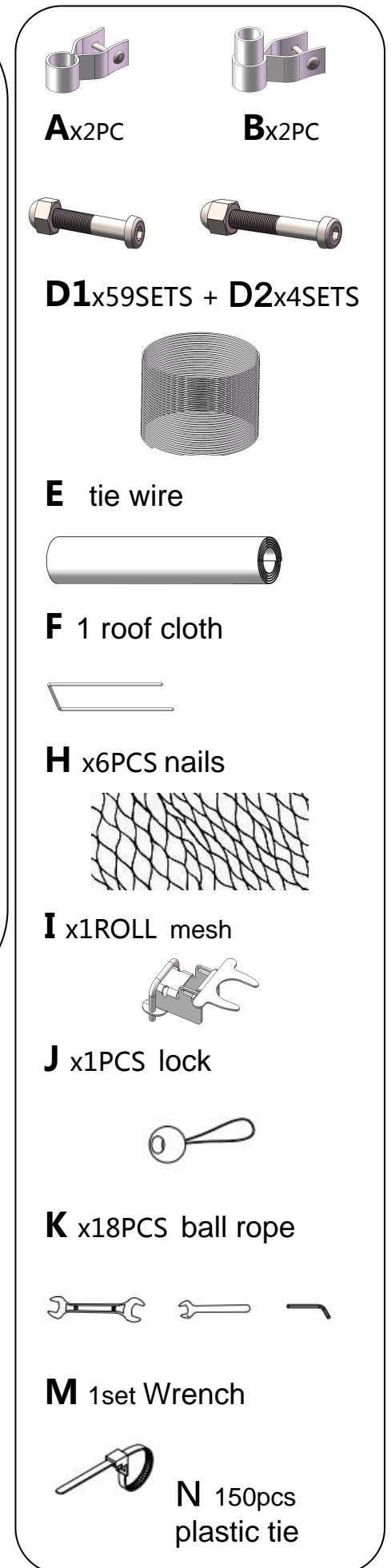

Step 1

Connecting bottom guide

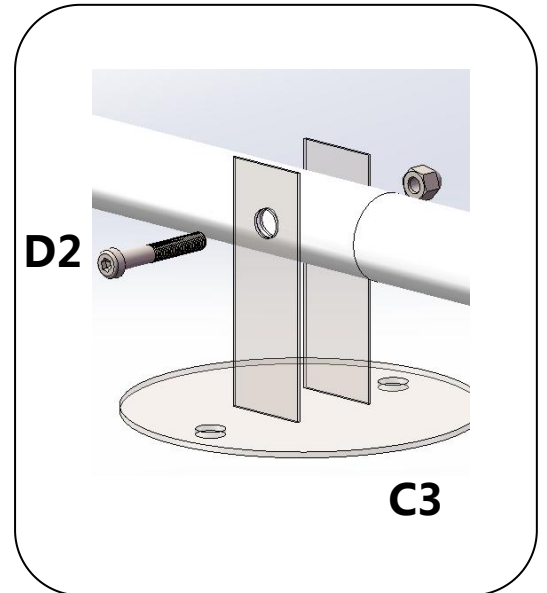
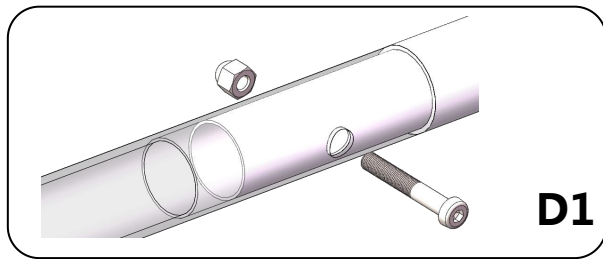
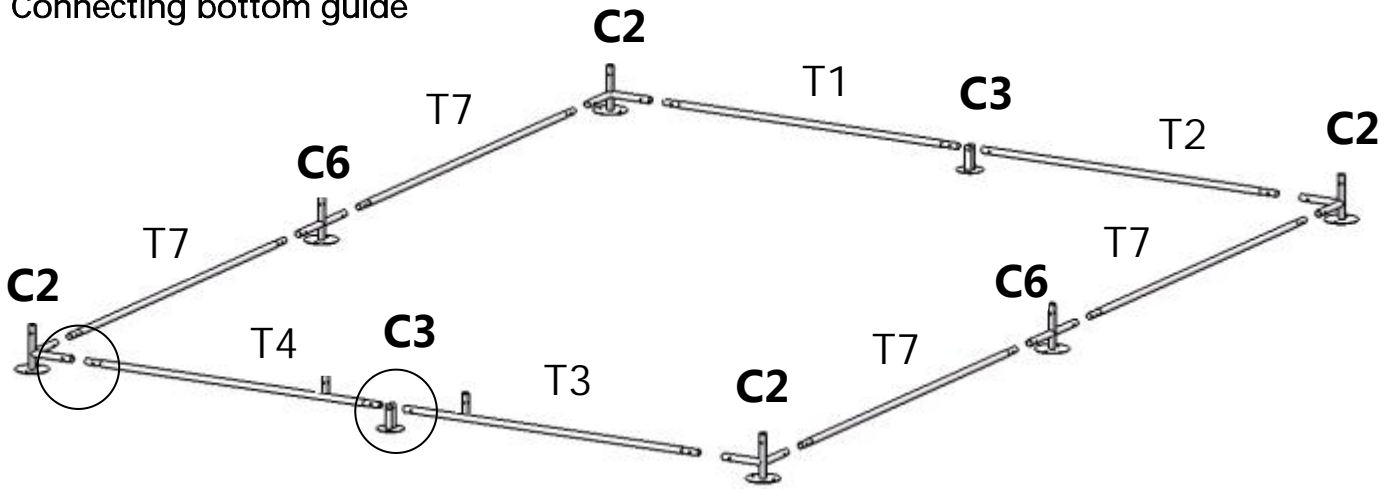

Step 2

Connect the standpipe

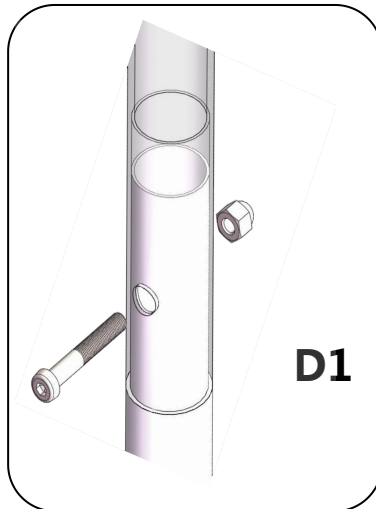
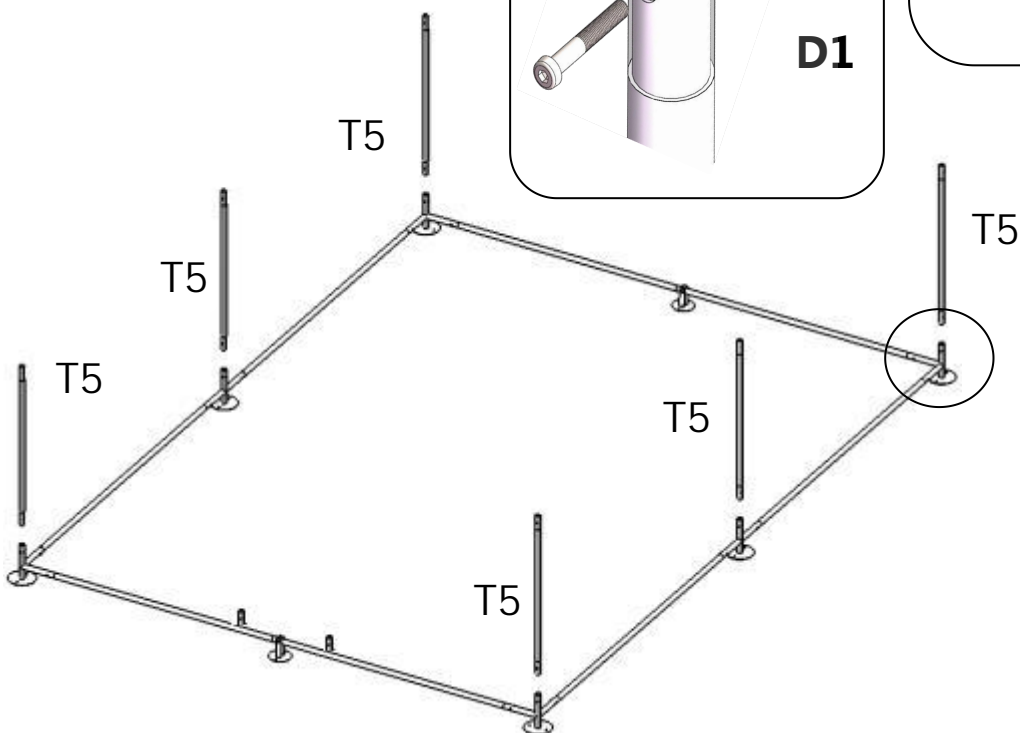

Step 3

Install ceiling pipe

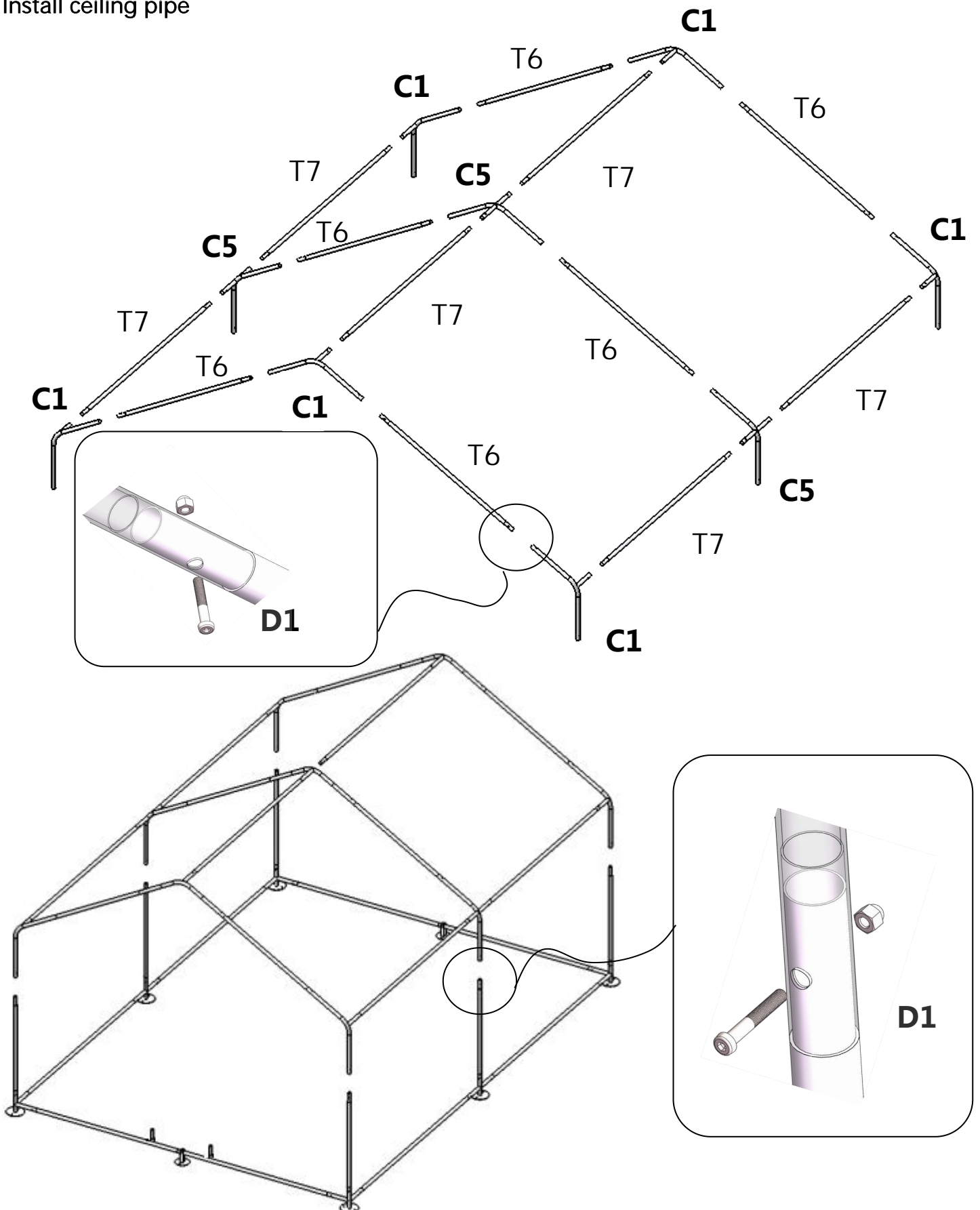

Step 4

Connect the door

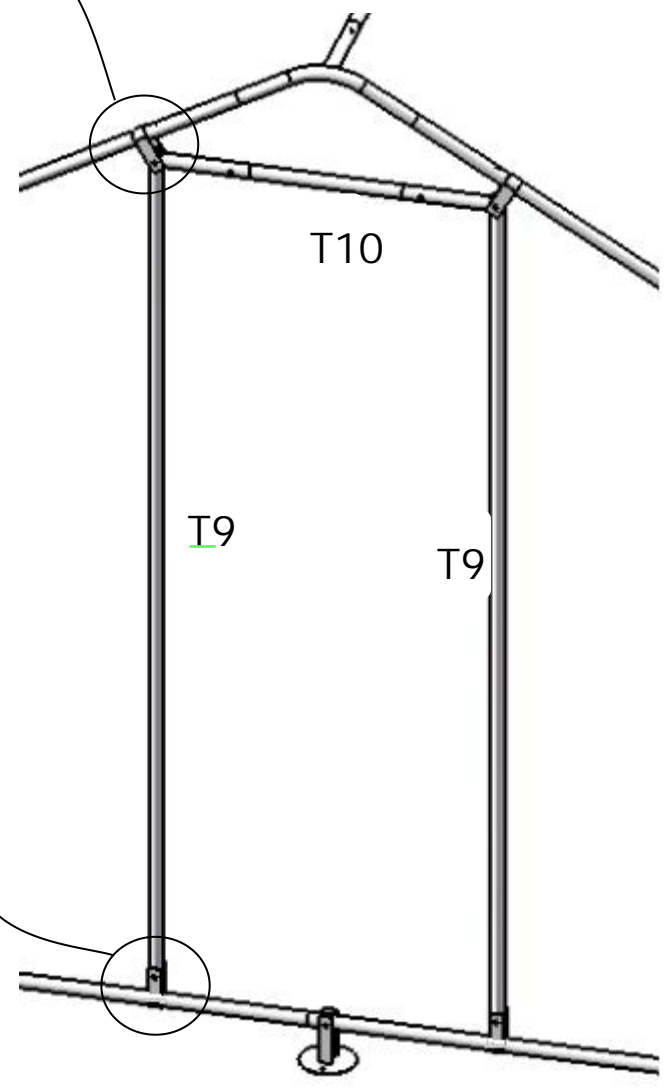
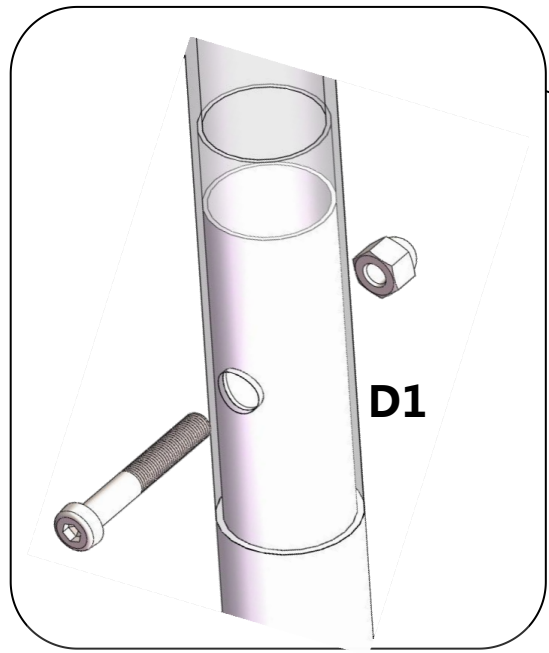
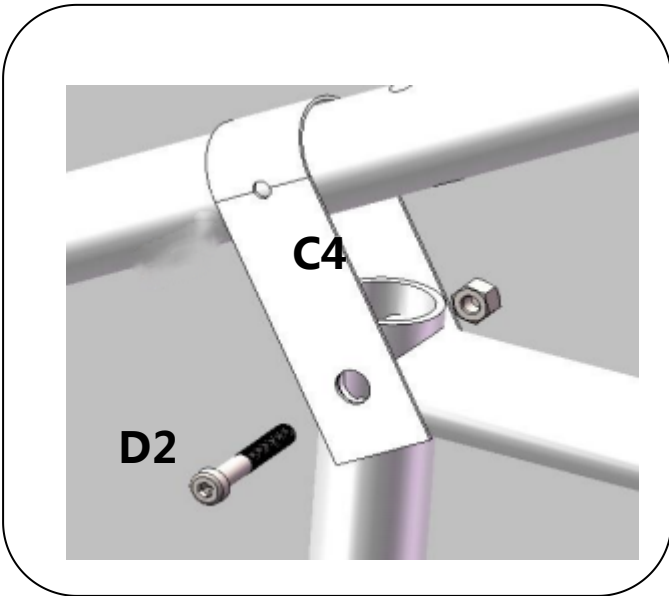
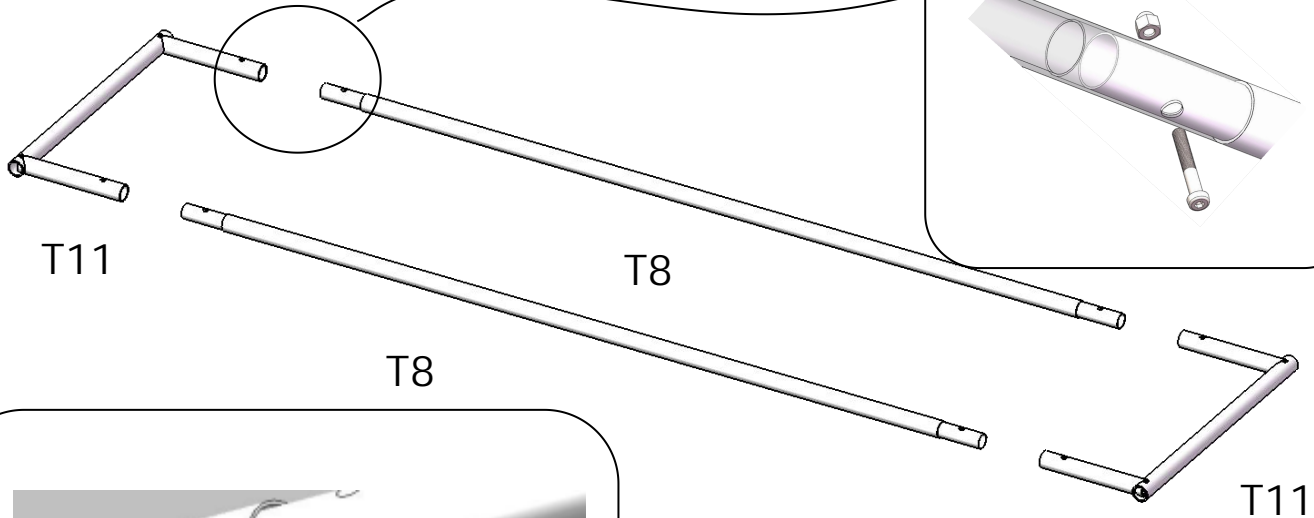

Connect the door

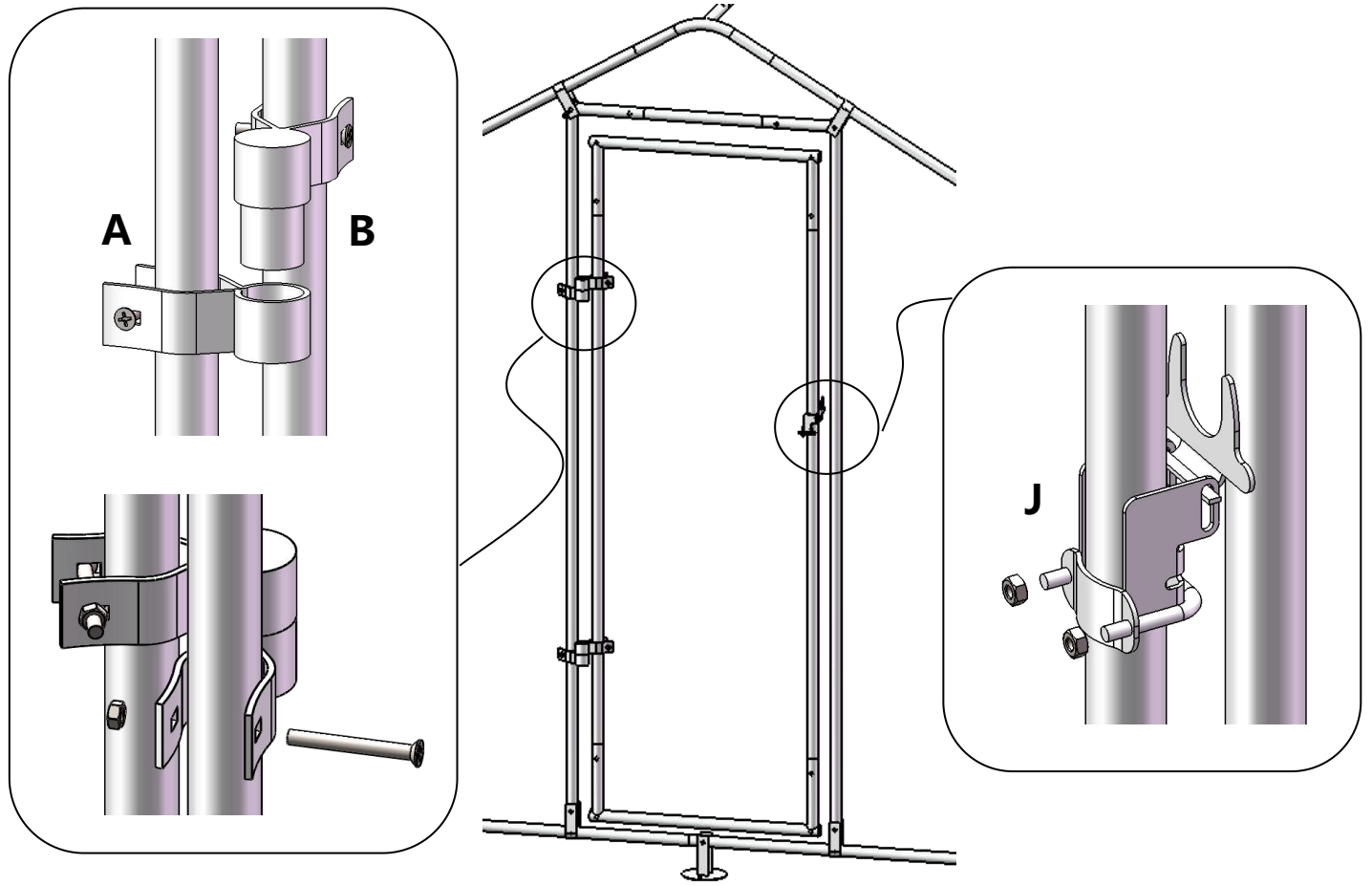

Step 5

Connect the mesh

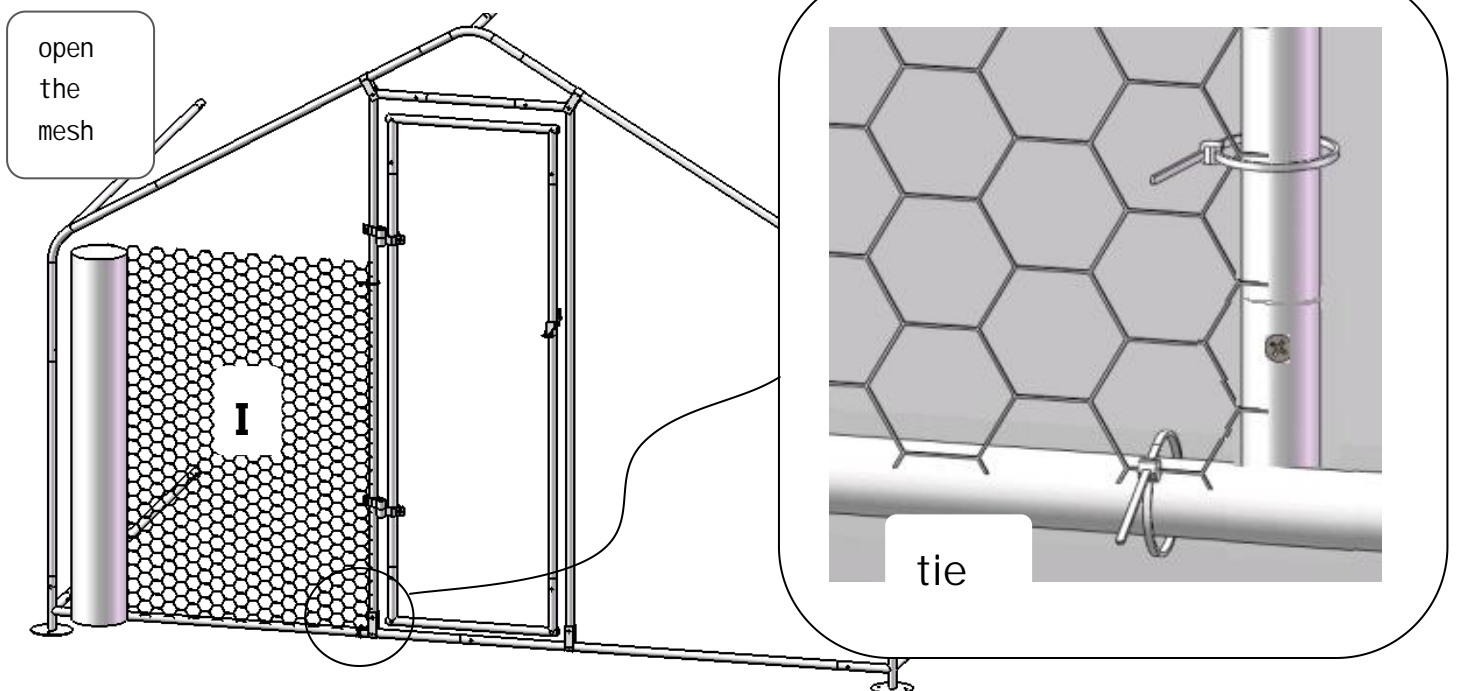

Tie mesh to the tube

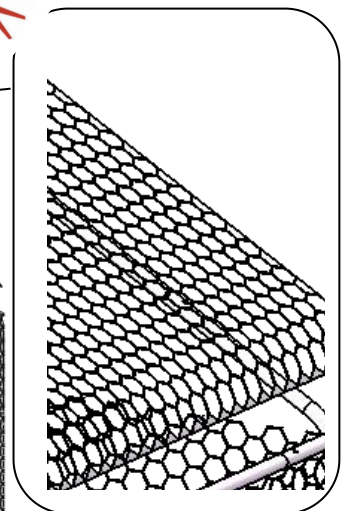
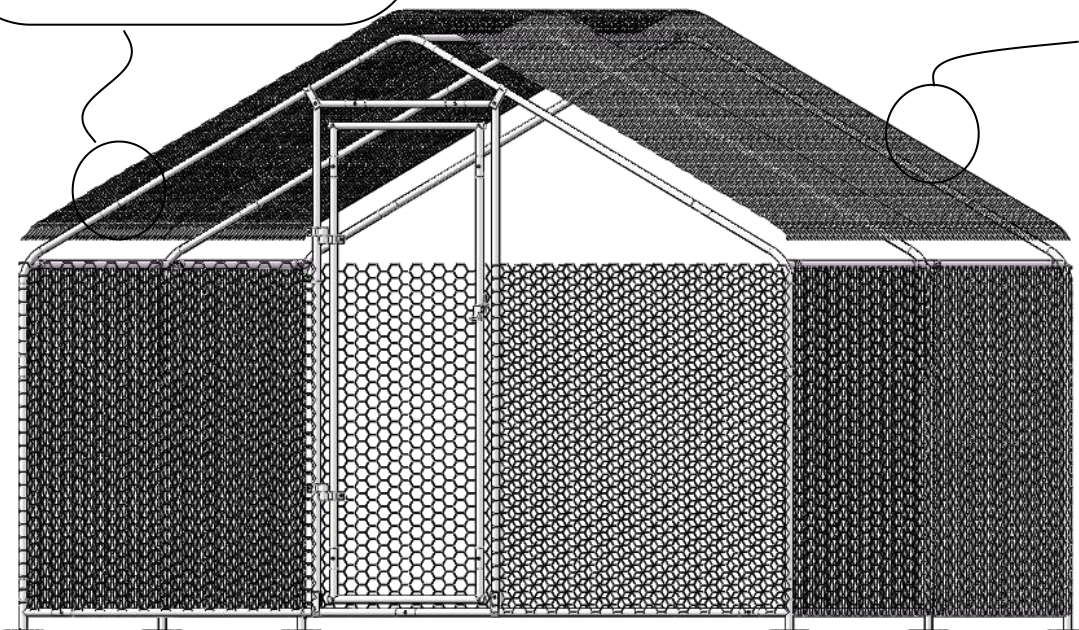
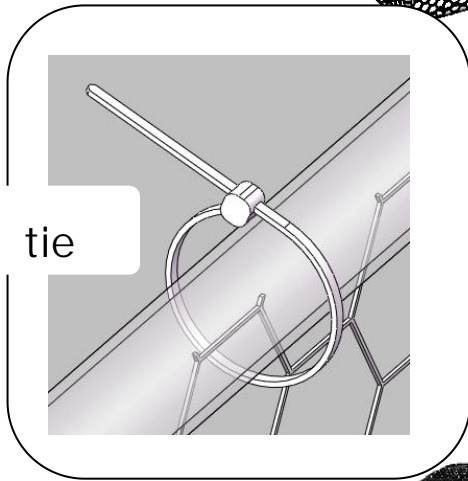
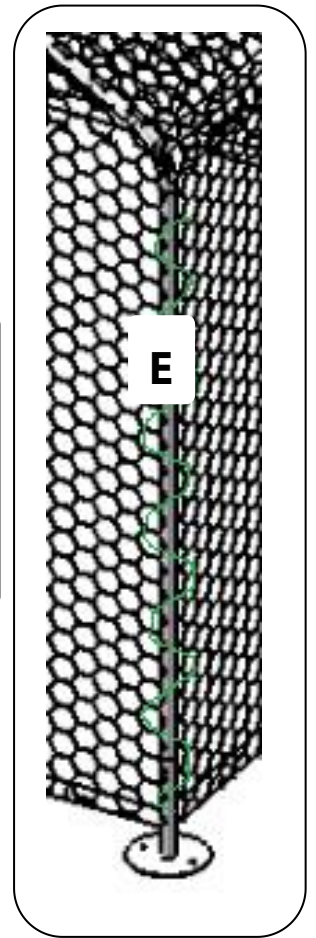
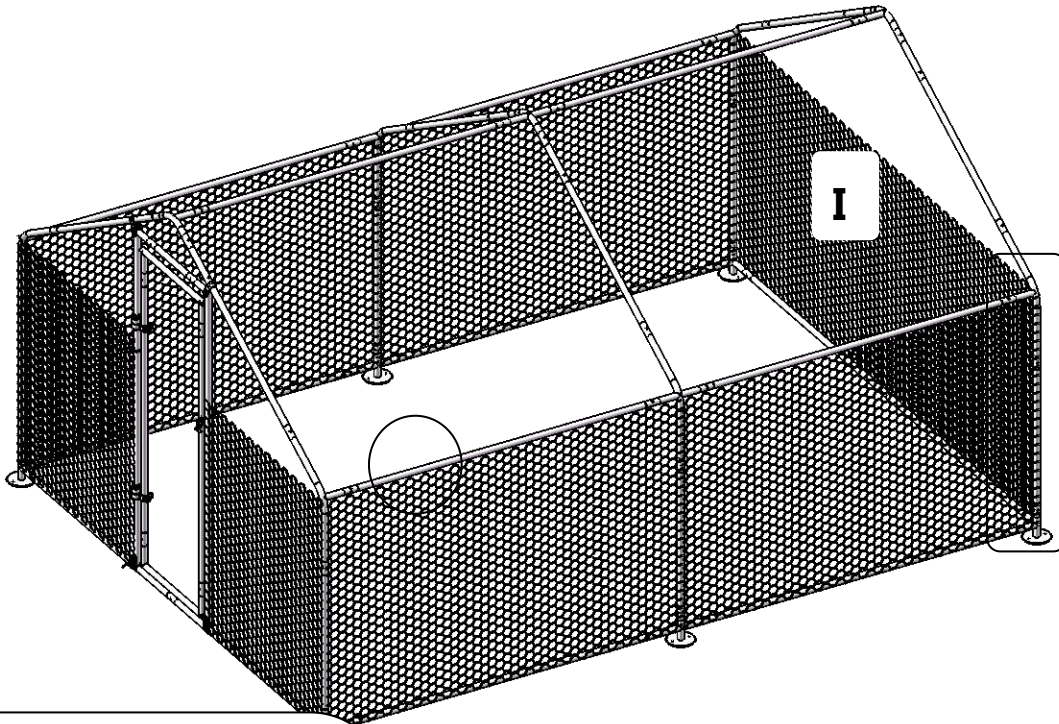

Cut mesh according to requirements

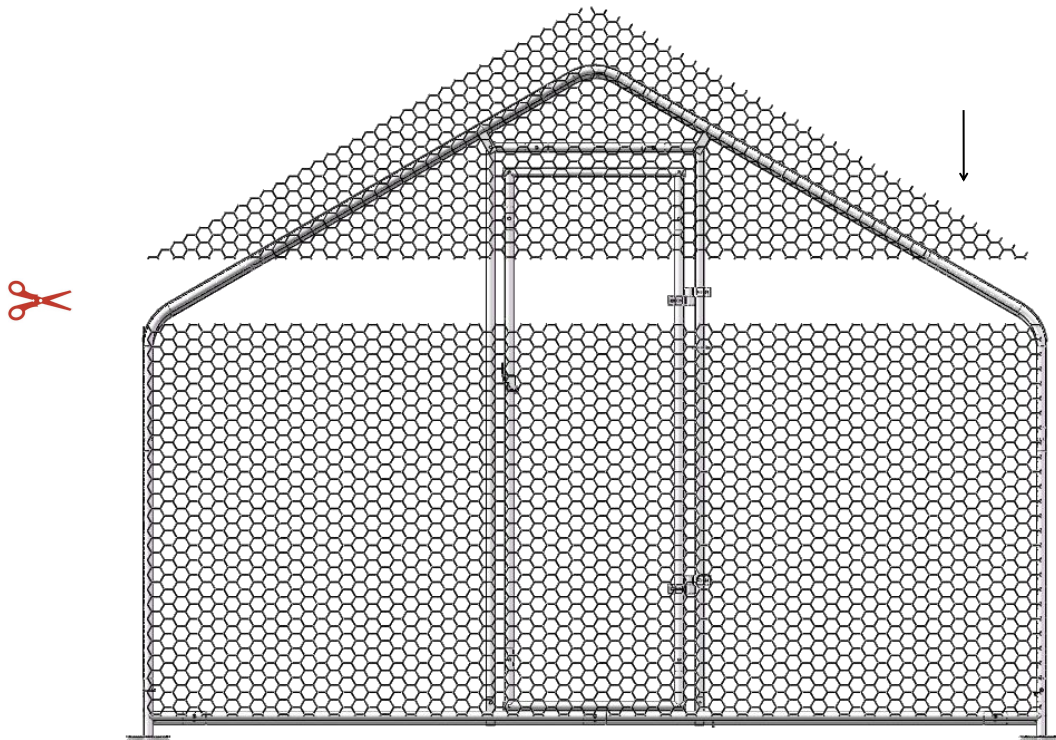
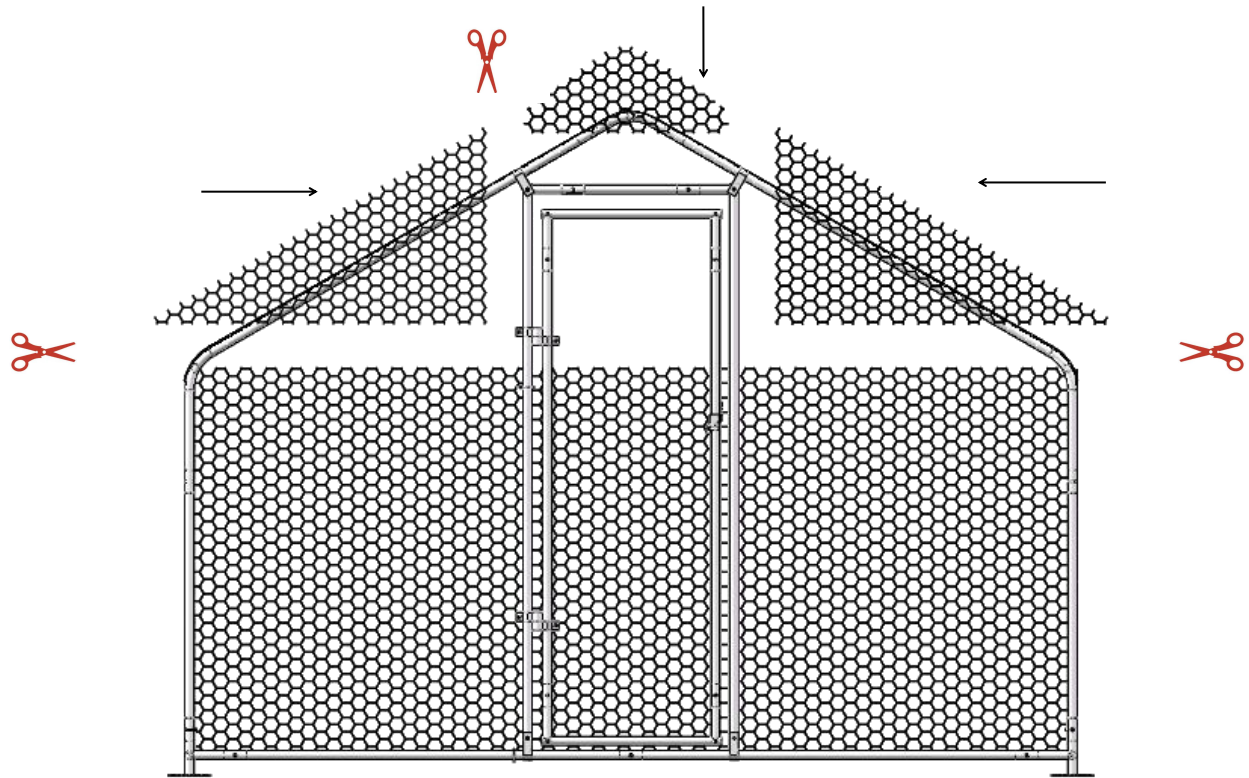

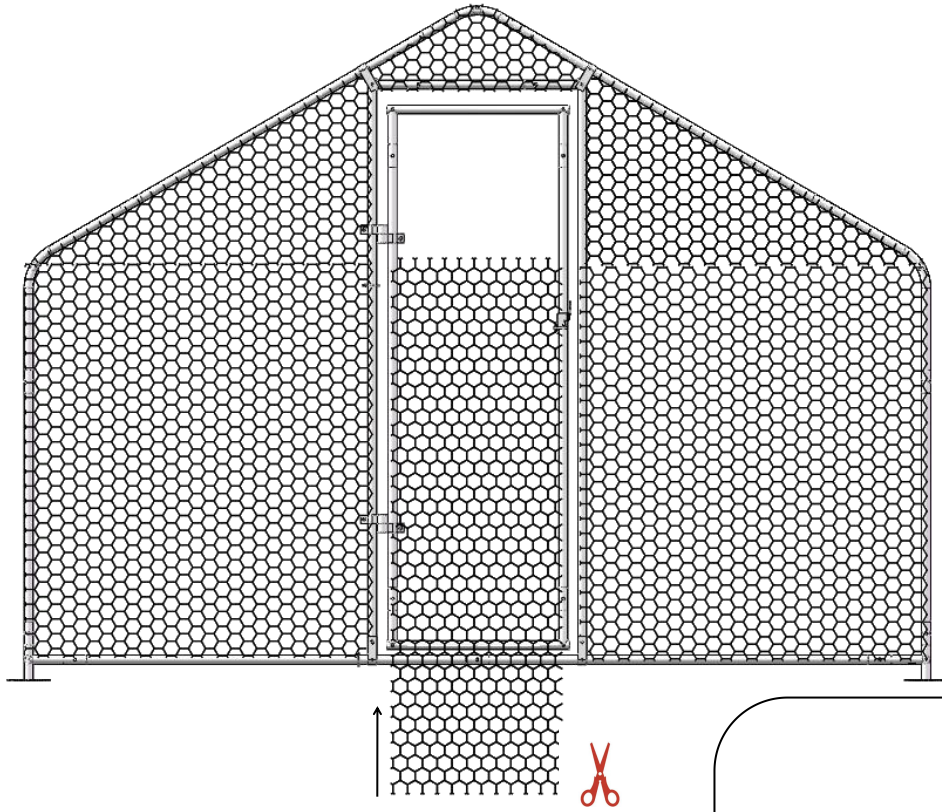

Step 5

Install the ceiling

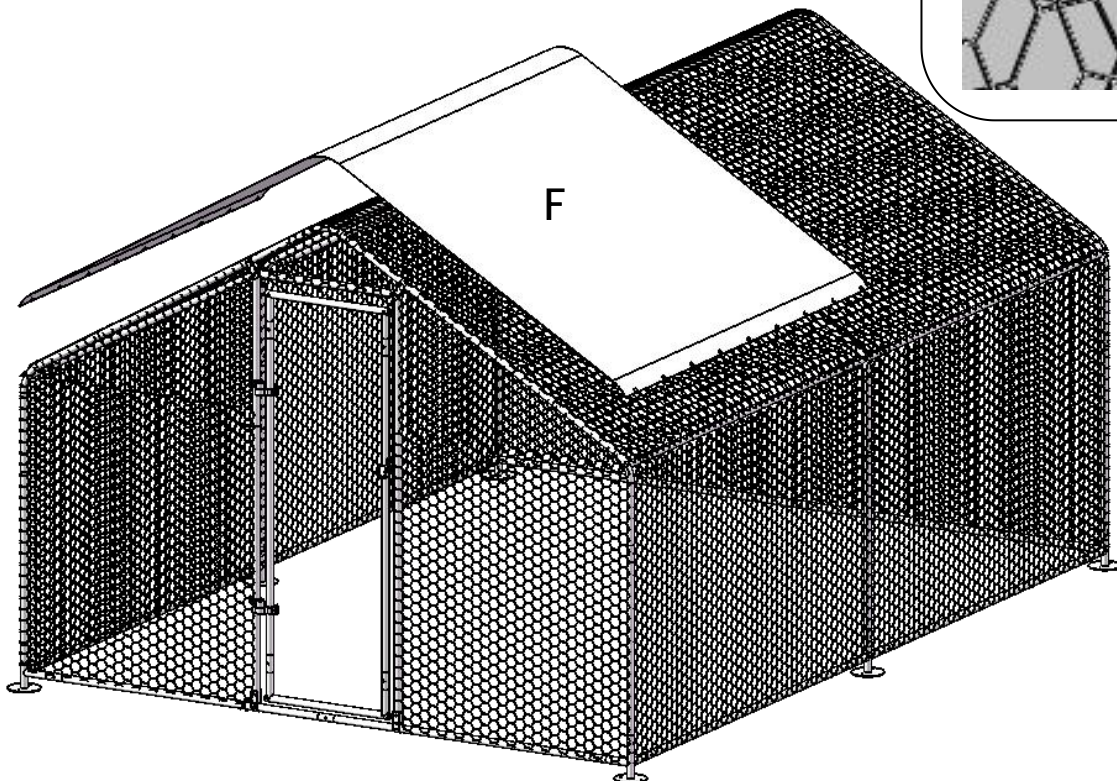
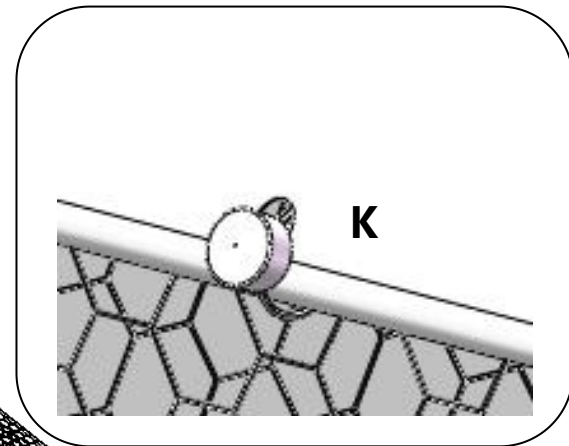

Tie the cloth to the tube

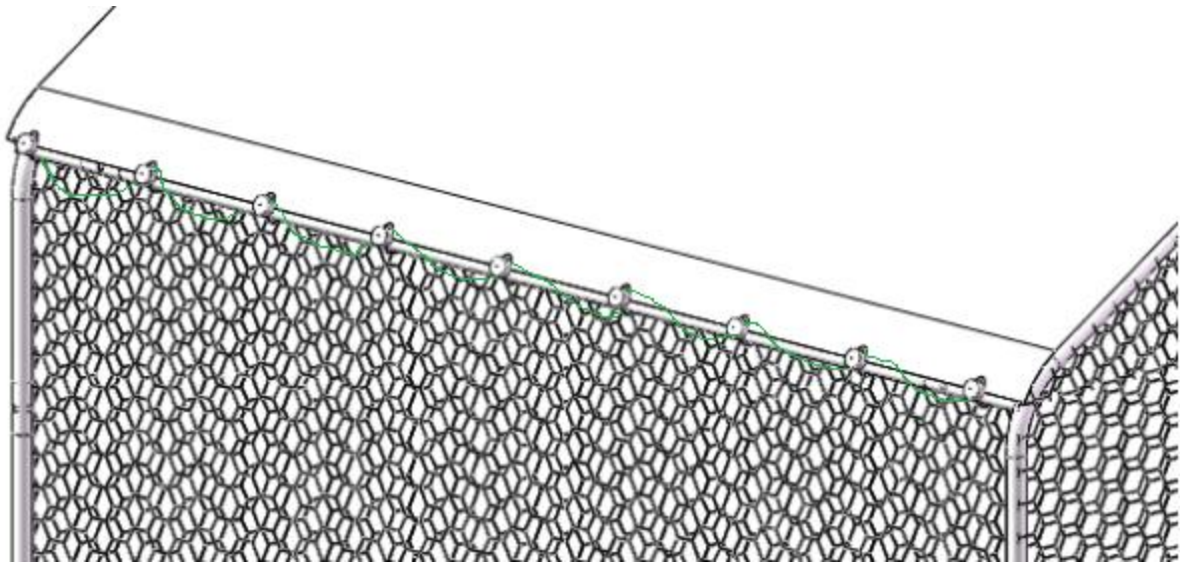

Step 6

Install the nail

