

Patio Cover

4mx4m

Installation Manual



	REF	QTY		REF	QTY		REF	QTY
Carton 1/4	A	1pc		B	1pc		C	2pcs
	G	7pcs		H	1pc		V	19pcs
Carton 2/4	D	2pcs		F	5pcs			
Carton 3/4	E	6pcs		Installation Manual	1set			
Carton 4/4	I	4pcs		J	2pcs		K	2pcs
	L	1pc		M	2pcs		N	3pcs
	O	2pcs		P	176pcs		Q	20pcs
	R	7pcs		S	5pcs		T	12pcs
	U	0						

Main components quantity (Patio Cover: 4mx4m)

Item code	Photo	Item name	Quantity	Item code	Photo	Item name	Quantity	Item code	Photo	Item name	Quantity
A		Wall eave	1	I		Post connector	4	Q		8*16 hexagon screws(with cap)	20
B		Gutter	1	J		Gutter cap	2	R		8*100 hexagon screws(with cap)	7
C		Post	2	K		Wall eave cap	2	S		10*100 hexagon screws(with cap)	5
D		Side frame	2	L		Downpipe connector	1	T		10*73 white plastic dowel	12
E		PC sheet	6	M		Elbow	2	U		Gutter inner connector	0
F		Middle frame	5	N		Pipe holder	3	V		Hard rubber strip	19
G		Little frame	7	O		Slide piece	2				
H		50 water pipe	1	P		4*16 screws	176				

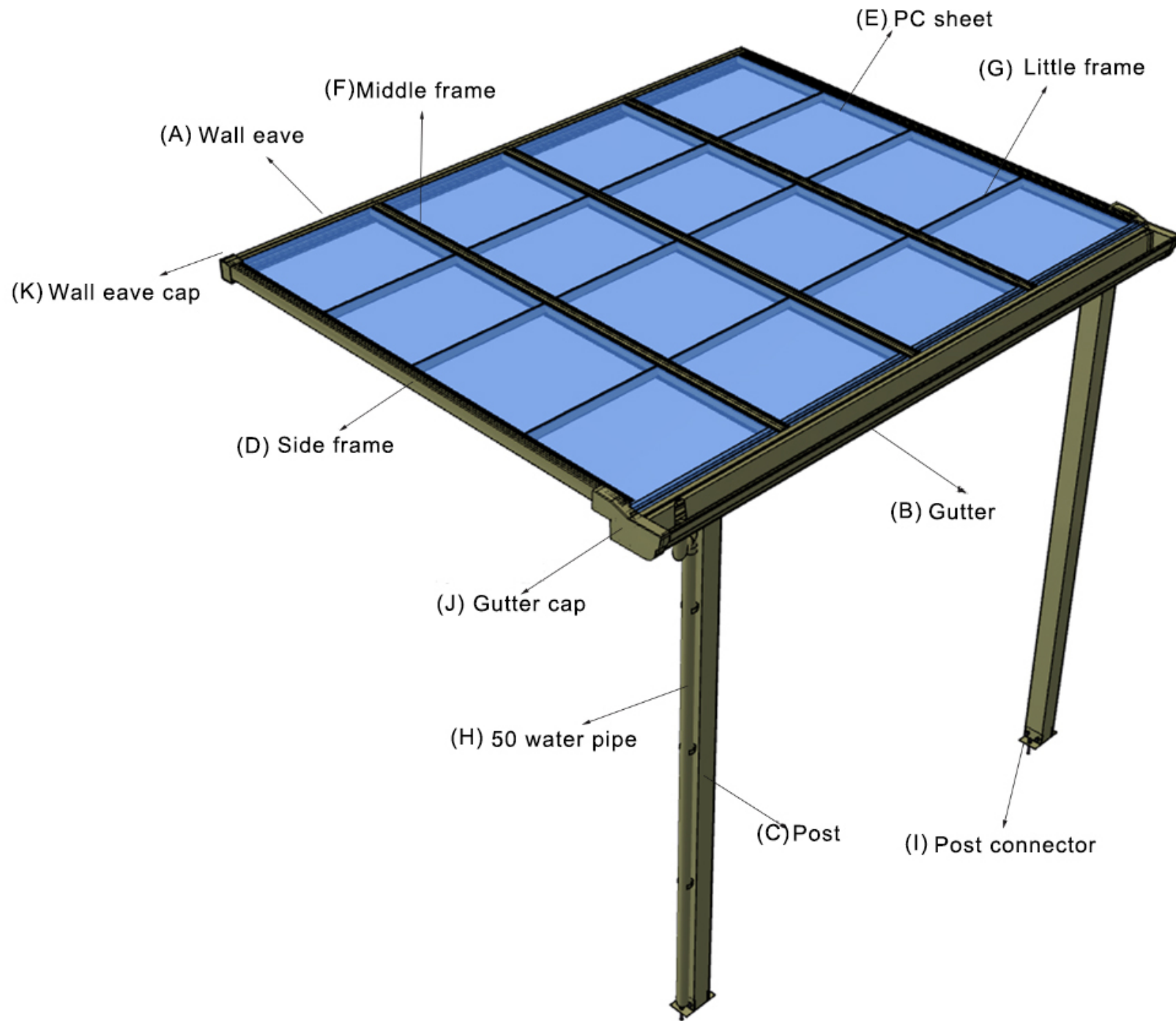

1. Wall eave installation

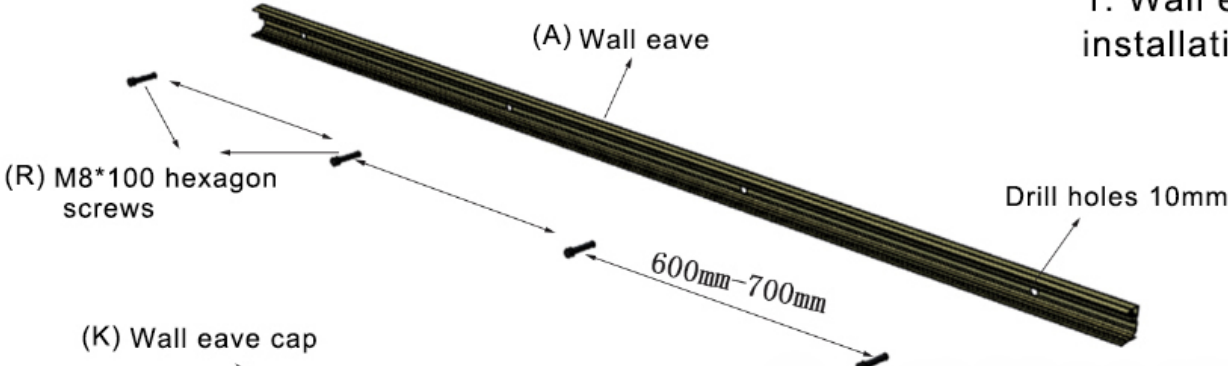

Confirm the installation position of the wall eave, drill a 10mm diameter hole in the wall, insert in the white plastic dowel, and drill the hole in the wall eave, the hole spacing is 600-700mm. When the wall eave is fixed on the wall, Apply a line of silicone(not supplied) to the surface which attaches to the wall, then fix the wall eave with M8*100 hexagon screws, apply silicone to the ends.

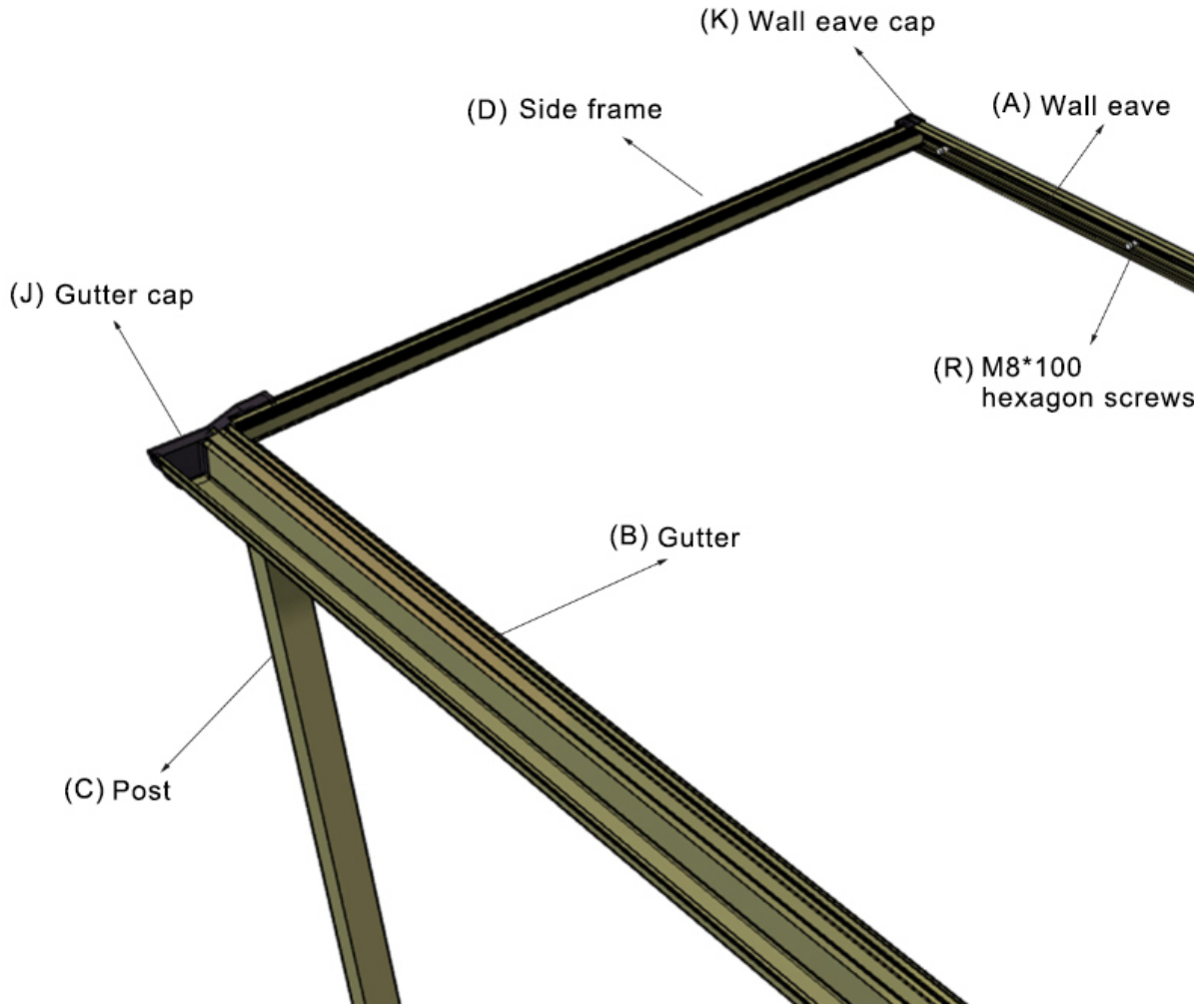

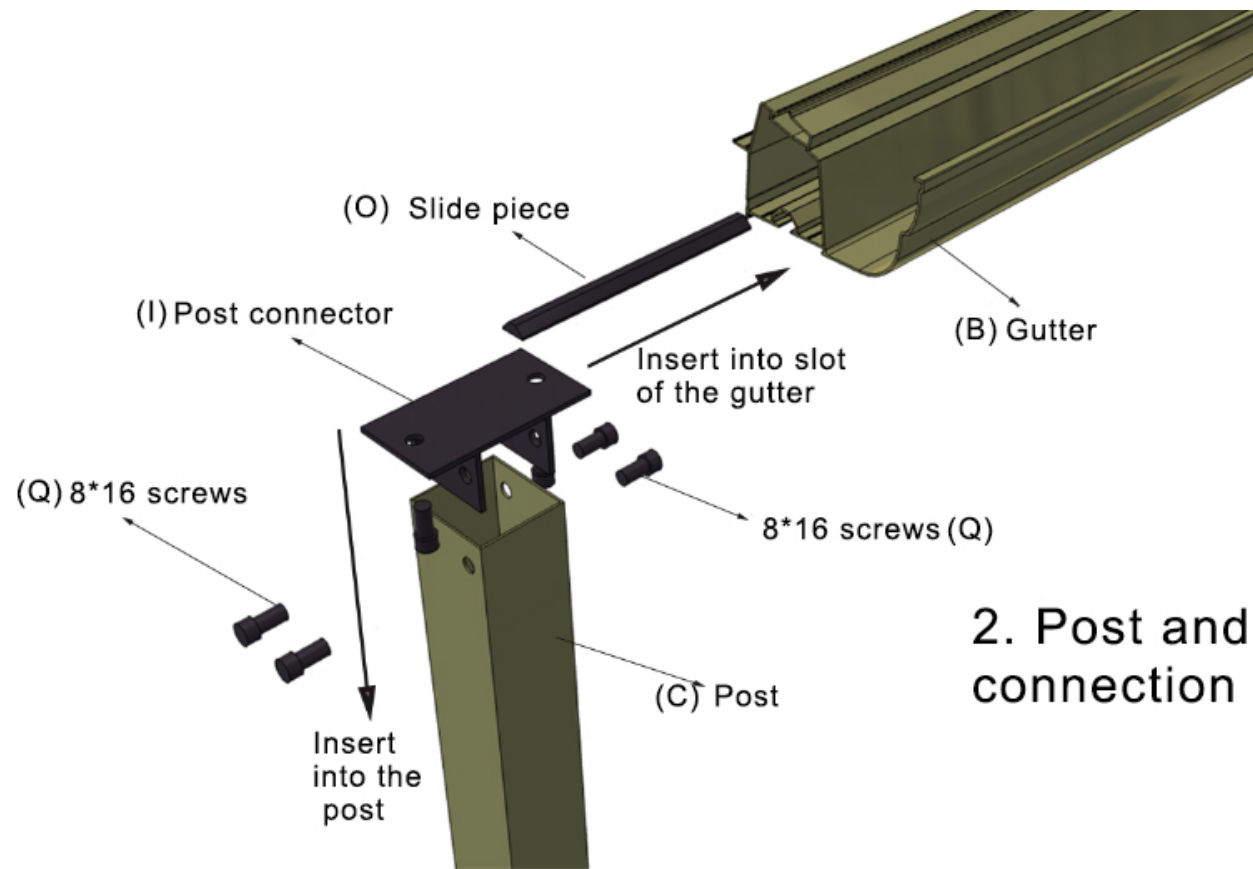

2. Post and gutter connection diagram

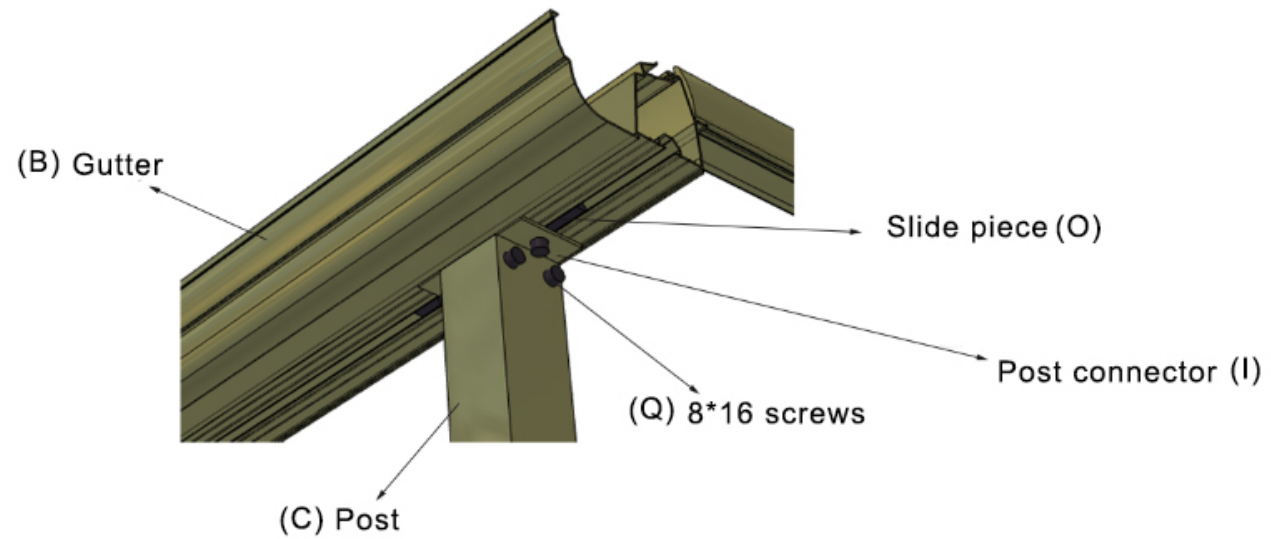

3. Side frame and wall eave/side frame and gutter connection diagram

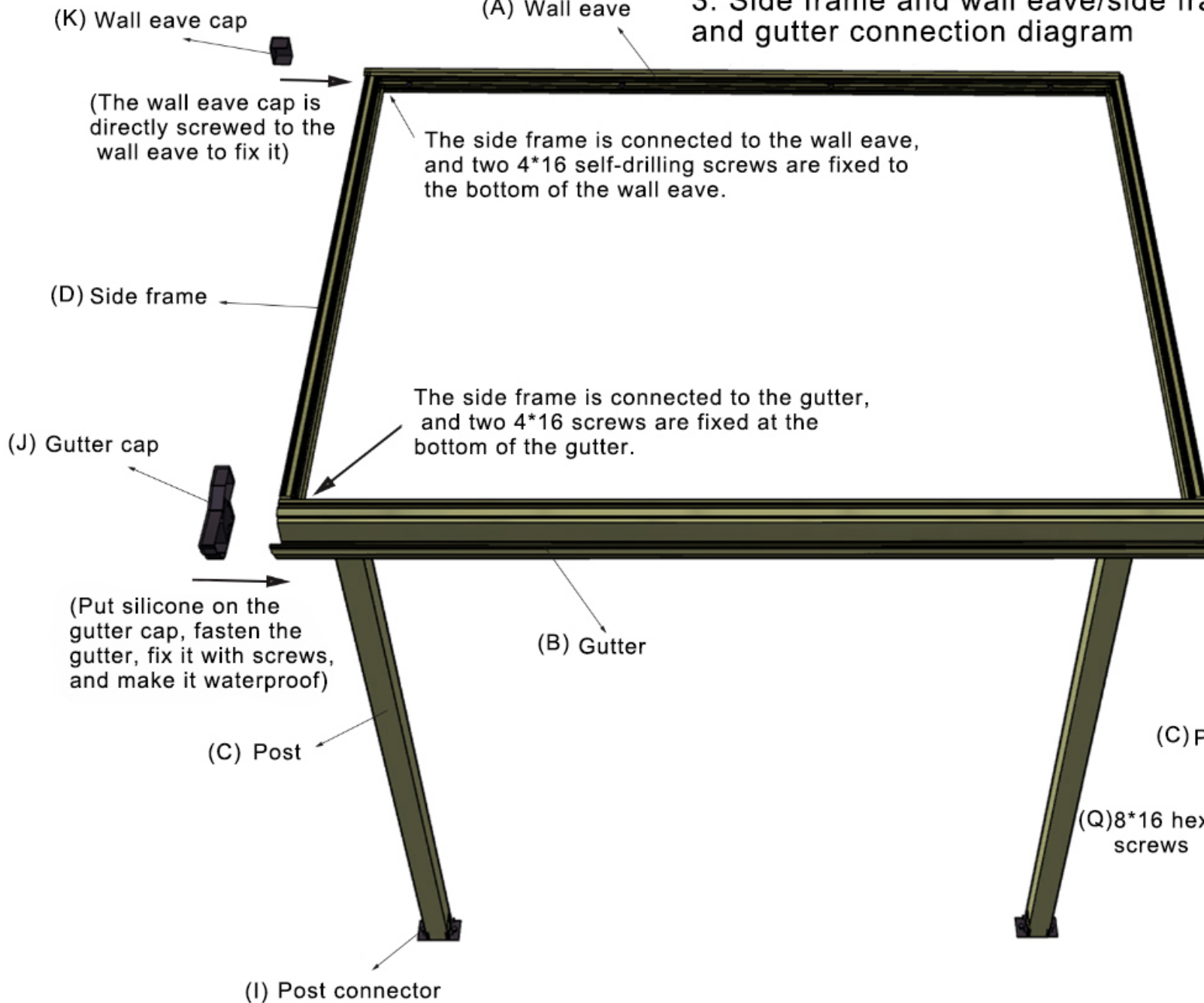

4. Diagram of fixing the bottom of the post

Determine where to fix the post, drill 12mm holes on the ground and insert white plastic dowels in, then use 8*16 hexagon screws to connect the post connector to the post. The post connector and the ground are fixed with 10*100 hexagon screws.

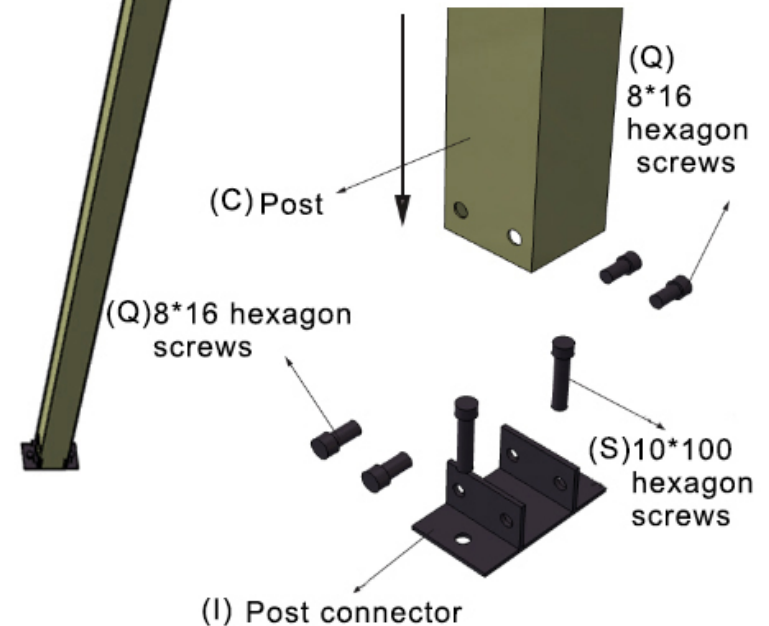

5. PC sheet/middle frame installation

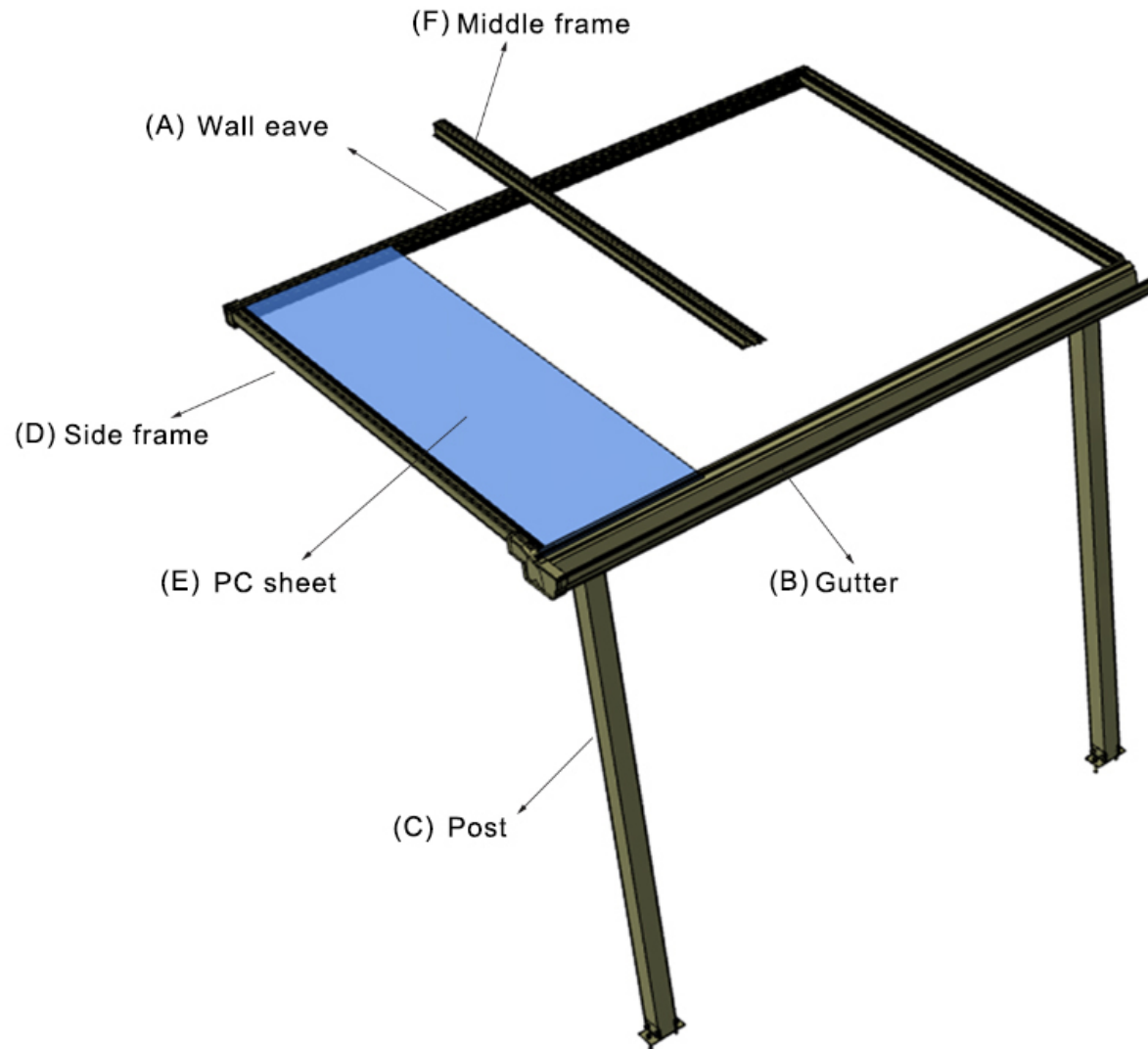

Insert the PC sheet into the frame slot, fix the middle frame with two 4*16 screws under the wall eaves, and fix it with two screws at the bottom of the gutter. Install the PC sheet and the frames in sequence, and remove the side frame to install the PC sheet when the last sheet is installed.

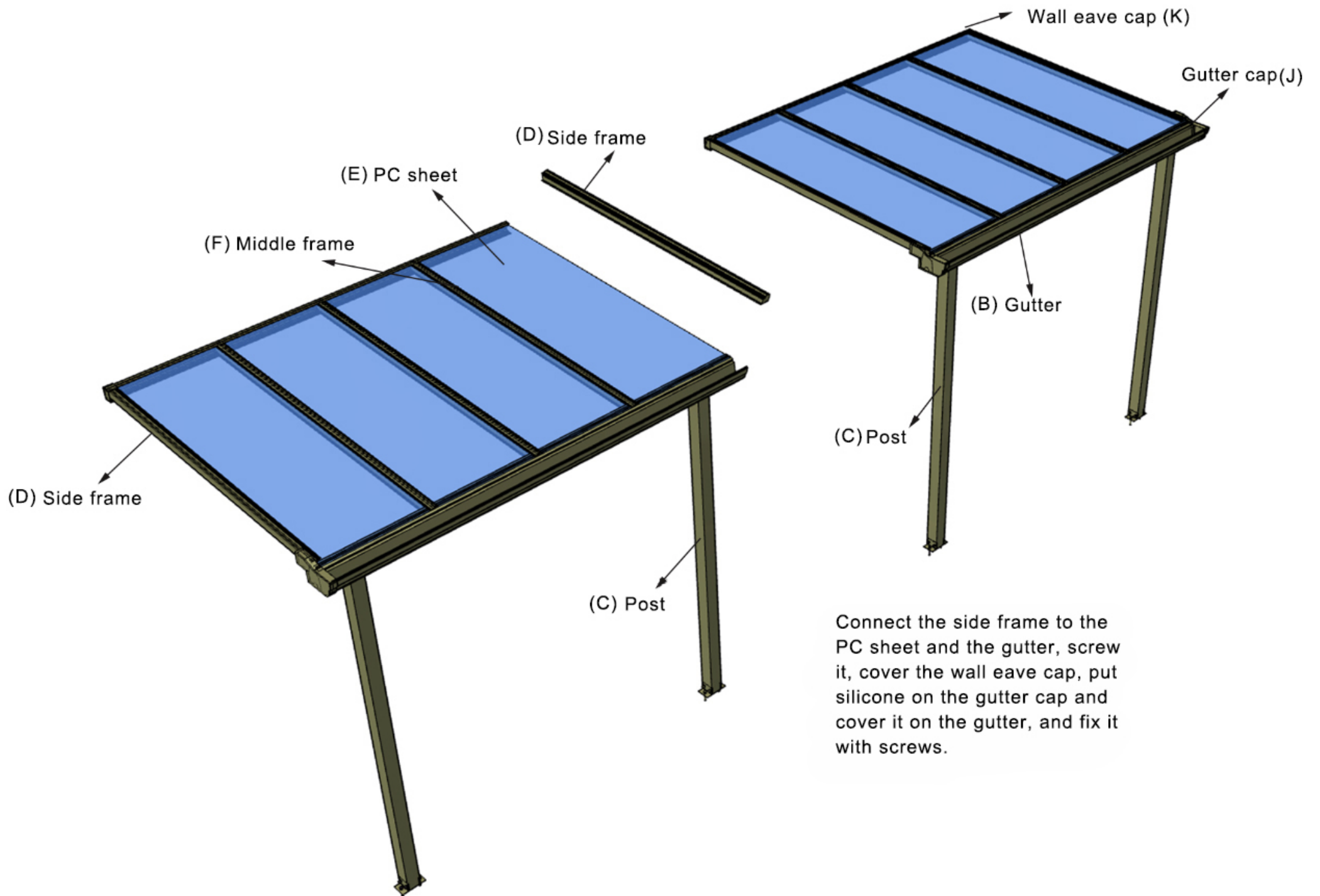

Connect the side frame to the PC sheet and the gutter, screw it, cover the wall eave cap, put silicone on the gutter cap and cover it on the gutter, and fix it with screws.

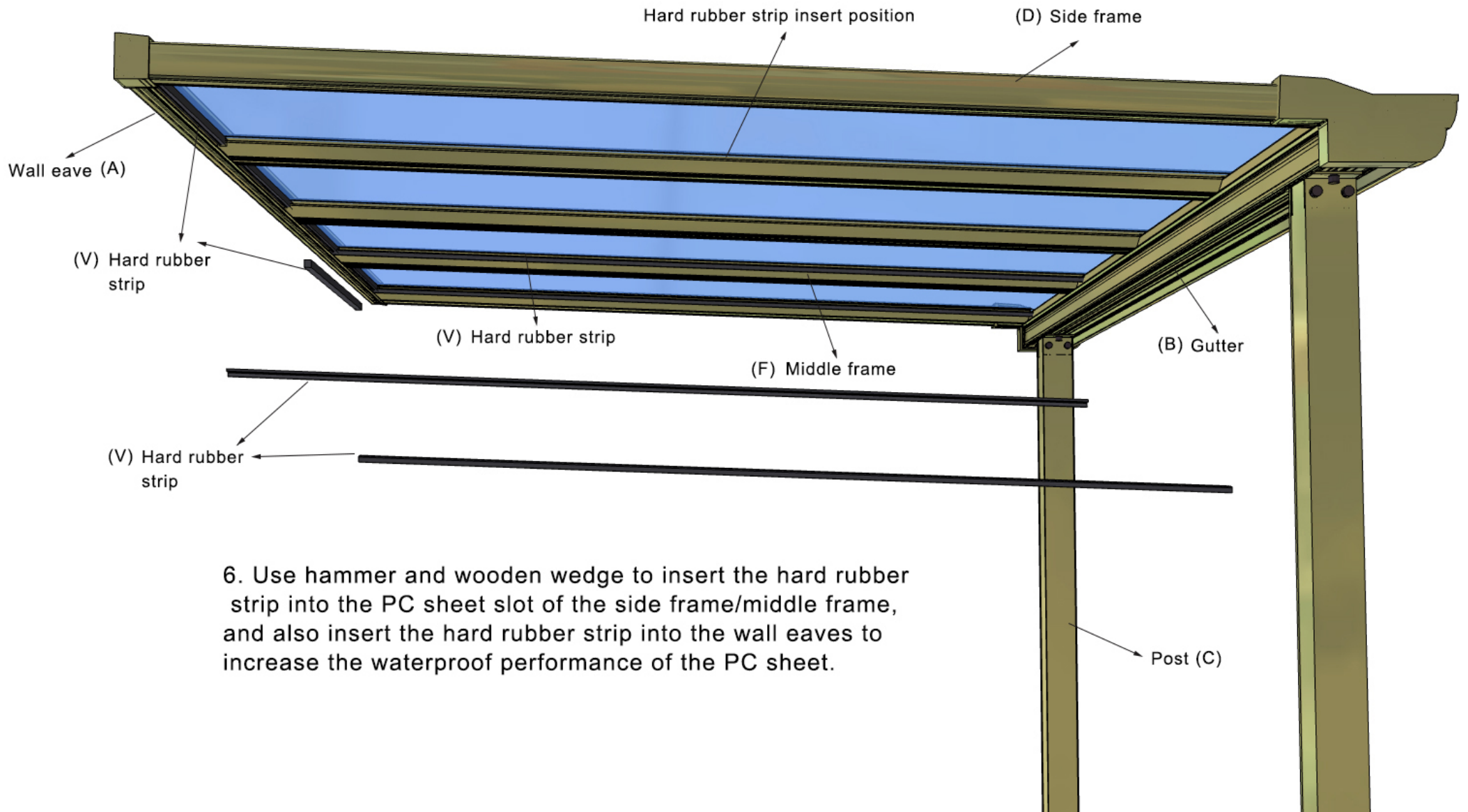

6. Use hammer and wooden wedge to insert the hard rubber strip into the PC sheet slot of the side frame/middle frame, and also insert the hard rubber strip into the wall eaves to increase the waterproof performance of the PC sheet.

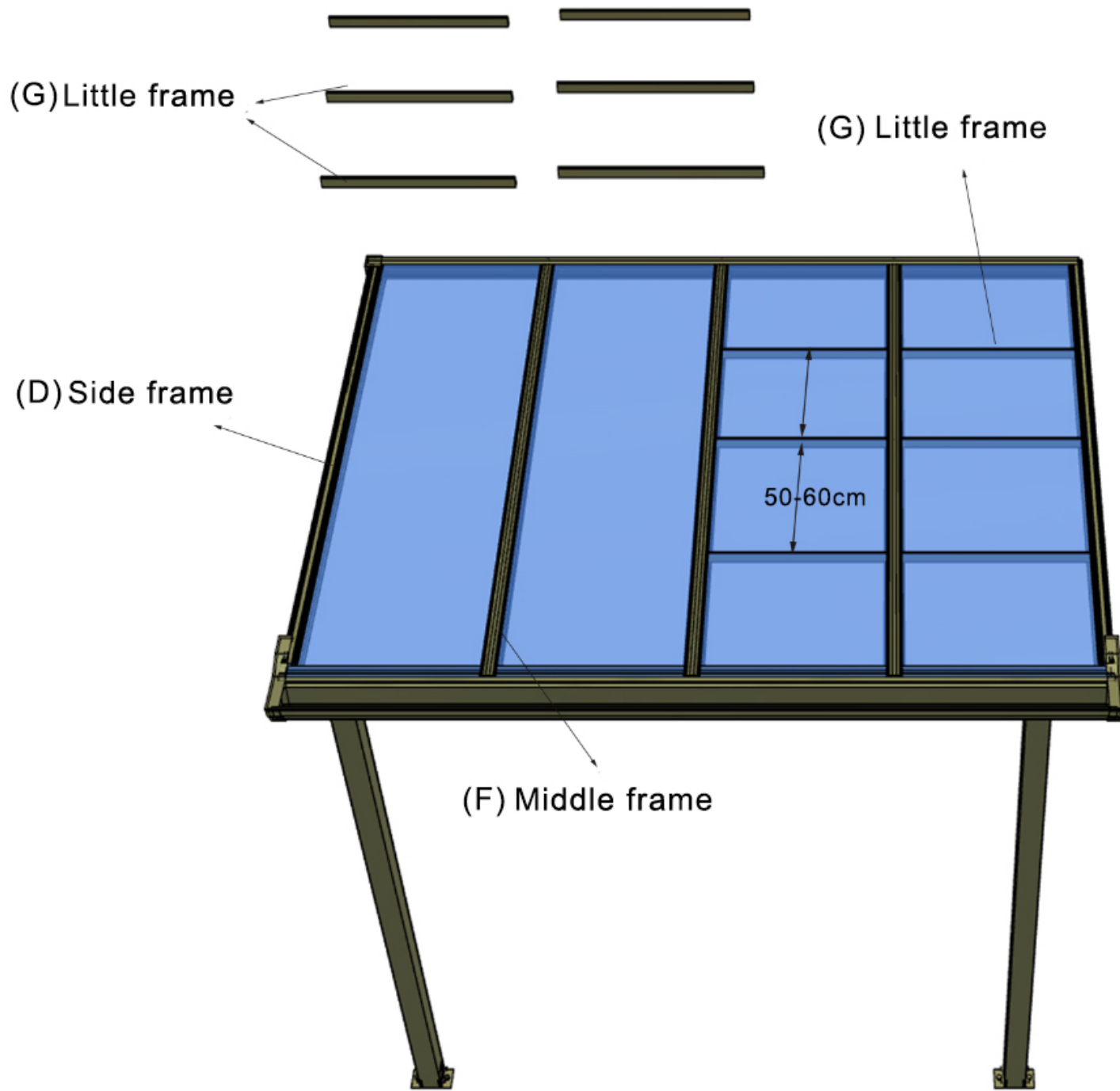

7. Little frame installation diagram

The length of the little frame is subject to the spacing between the frames, cut it well, and fix it in the middle of the frames, with a spacing of 50-60cm. The two ends of the little frame are fixed with 4*16 screws to fix the roof structure.

8. Water pipe installation diagram

Determine the position of the drain outlet under the gutter, use hole saw to open the 35-40mm diameter hole, apply silicone when installing the downpipe connector, fix the elbow/water pipe with screws, apply silicone to the connection to make it waterproof. Fix the 50 pipe holder on the post with 4*16 screws.

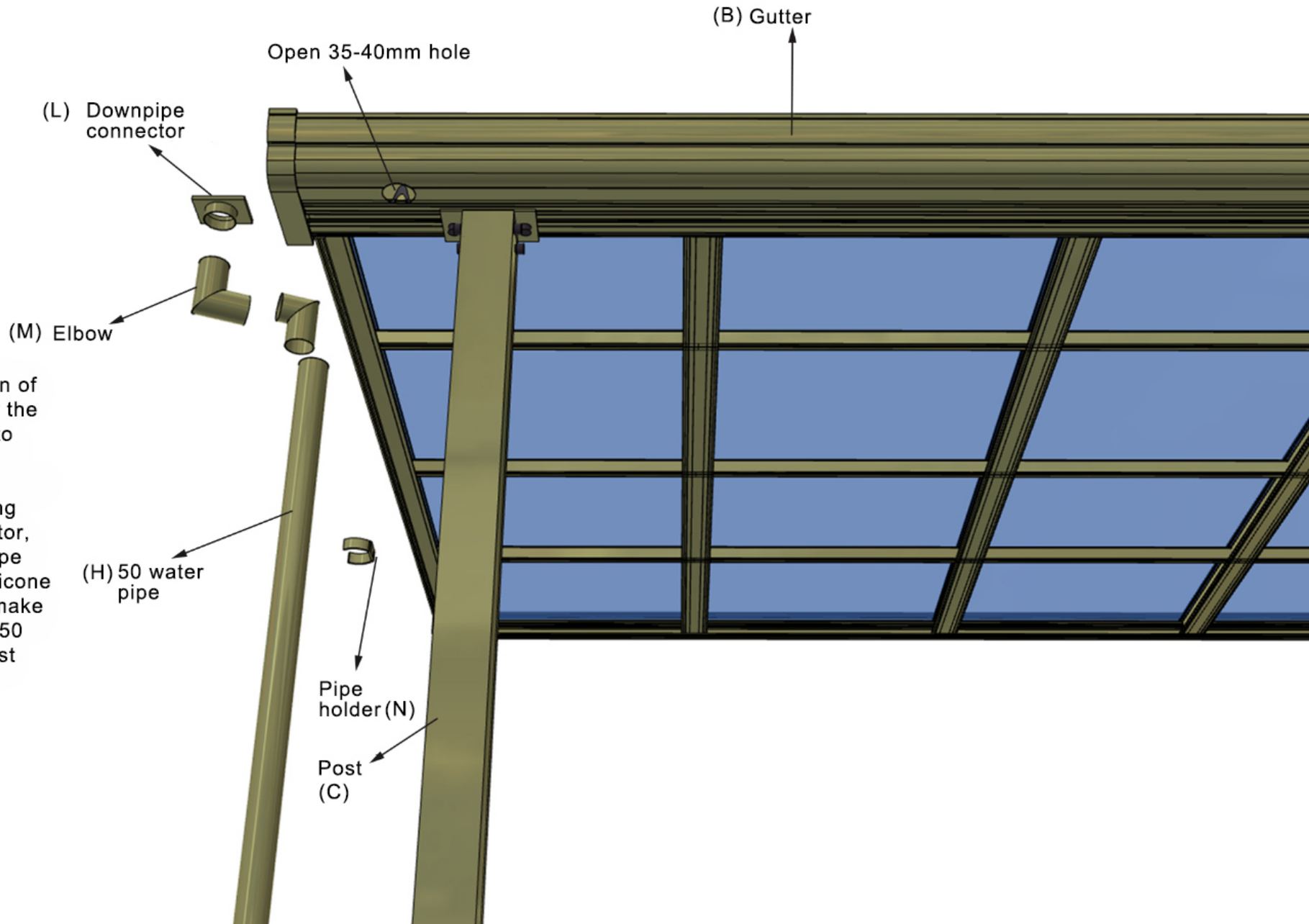



9. Installation
is complete