

Guidelines for Gas Cylinder Safety

For the latest version visit www.boc.com.au



Contents.

- 04 Introduction.
- 05 Know your gases.
- 11 About your cylinders and valves.
- 16 Ordering, transport and handling of cylinders.
- 23 Storing your cylinders safely.
- 25 Care of cylinders.
- 27 Working with gas cylinders.
- 31 Keeping your equipment safe.
- 32 If something goes wrong.
- 35 Keeping your environment safe.
- 38 Glossary.

BOC is committed to practising and communicating safe operations around the world as part of its commitment to robust product stewardship.

It is as important for BOC to impart safe working methodologies to customers and suppliers as it is to have clear, established and measurable performance standards practised by all BOC plants, depots and distributors – regardless of plant, product or service.

BOC has:

- Safety as its highest priority.
- One simple goal: zero incidents and injuries.
- Well-established programmes to drive improvement in SHEQ (Safety, Health, Environment, Quality) performance.

Introduction.



Many people across a wide range of industries, including manufacturing/maintenance, medical, hospitality, science and education use gases from compressed gas cylinders. The pressure at which gases are contained in gas cylinders can be extremely high. Continual advances in cylinder technology will enable pressures to be increased even further.

To maintain and continue to improve the current safety record for the use of these cylinders, increased knowledge and understanding of the DO's and DON'Ts is essential.

For new users of gas cylinders, it is essential that they receive adequate training and guidance prior to use.

These guidelines distill the experience and knowledge of various experts in an effort to provide guidance for safer handling of gas cylinders.

They focus on a number of known issues and on situations where the same or similar incidents have reoccurred.

Every possible issue or occurrence can neither be anticipated nor covered.

If in doubt, call the **BOC Emergency Response line on 1800 653 572** in situations or occurrences that fall outside guidelines.

It is recommended this document be kept for handy reference by every:

- Manager
- Engineer
- Foreman
- Tradedperson
- Storeperson
- Operator
- OHS personnel

Scope of these guidelines

These guidelines cover compressed and liquefiable gas cylinders as shown on the 'Gas cylinder colour identification' on pages 8-9.

Please note that the identification of the gas contents of any cylinder is given by the label on the cylinder and is qualified by the colour(s) of the cylinder, and the cylinder valve outlet.

These guidelines touch on toxic gases (e.g. Ammonia which is used as a refrigerant) but do not cover these gases in detail as these are considered generally the domain of special gases.





Legislation and standards

This gas cylinder information booklet is intended as a guide. Product users should also refer to relevant legislation, regulations, codes of practice and Australian Standards

BOC is committed to promoting the safe handling of gases wherever possible and hopes that this document will serve as an educational tool outlining the potential hazards of working with gases as well as promoting safer practices around their use, handling and transport.

Know your gases.

Main gases hazard classifications.

Oxidising Gas	Flammable Gas	Toxic Gas	Non-flammable, non-toxic Gas
Division Diamonds  Division 2.2 / 5.1 Diamond: Yellow Lettering: Black	 Division 2.1 Diamond: Red Lettering: Black or White	 Division 2.3 Diamond: White Lettering: Black	 Division 2.2 Diamond: Green Lettering: Black
Australian Standards Definition A gas which gives up oxygen readily, removes hydrogen from a compound, or readily accepts electrons.	A gas which will burn in air at a pressure of 101.3 kPa absolute.	A gas that is known to be a toxic or corrosive to humans as to pose a hazard to health; or b presumed to be toxic or corrosive to humans because it has an LC 50 value equal to or less than 5000 ml/m ³ (ppm).	A gas which is non-flammable, non-toxic, non-oxidising, and is resistant to chemical action under normally encountered conditions.
General Definition Many materials which will not burn in air may readily ignite and or burn in the presence of an oxidising gas – e.g. oxygen. This includes work clothing and many materials considered non flammable.	Flammable gas in the presence of the correct mix of air and an ignition source will lead to combustion.	A gas that is known to be so toxic or corrosive to humans as to pose a hazard to health.	A gas which is non-flammable, non-toxic, non-oxidising, and is resistant to chemical action under normally encountered conditions. The displacement of oxygen or air by an inert gas may pose a risk of asphyxiation.
Cylinder Colour Identification Hues of Black, White, or bright Blue	Hues of Red	Hues of Yellow	Hues of Brown, Green or dark Blue

Associated risks and hazards of handling gases

Since gases are invisible their presence is not readily identifiable, but they do have the potential to asphyxiate, burn or harm users.

An important part of the label is the Division (Class) Diamond which represents the characteristics of the gas (see above).

Each year in Australia, there are incidents which involve the use of compressed or liquefied gases.

Many of these could have been avoided if the user had followed information contained in the Safety Data Sheet (SDS) or had referenced this document or other similar freely available information.

Label

The cylinder label is the primary means for identifying the contents of a gas cylinder and the nature and hazards associated with the gas contained in the cylinder (see next page).

DO NOT use a gas cylinder if the label is missing or illegible, or if the heat tag has been damaged. Return it to BOC or the agent/outlet you purchased it from for a satisfactory replacement.

Cylinder colour

The cylinder colour is the secondary means for identifying the nature and hazards associated with the gas contained in the cylinder.

Additional Information

In the interests of personal safety, customers MUST familiarise themselves with the respective SDS and gas equipment operating manuals.

Copies of current SDSs for each of the gases stored and used must be collated and kept in a convenient location for quick reference in relation to:

- Storage
- Handling
- Transport issues
- Personal Protective Equipment
- Incident response

SDSs for BOC gas products are available from www.boc.com.au or by contacting the BOC Customer Service Centre on 131 262.

BOC cylinder and pack identification label.



BOC cylinder label





- 1 BOC Gas Trade Name
- 2 United Nations (UN) number and proper shipping name for safe handling, transport and storage
- 3 Dangerous Goods Classification
- 4 BOC gas code and cylinder size
- 5 Contents of cylinder at standard temperature and pressure i.e. (15°C @ 101.3 kPa)
- 6 Nominal filling pressure at standard conditions (for permanent gas)
- 7 Caution - indicated major hazards*
- 8 General safety information*

*Always refer to Safety Data Sheet (SDS)



Labels vary in shape, size and their positioning on cylinders and packs.

Primary hazards for commonly used industrial gases

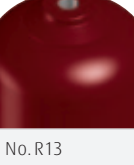
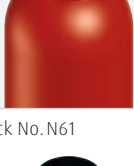
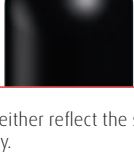
Major Hazard	Gas	Cylinder Colour	Characteristics
Asphyxiant	Carbon Dioxide	Green Grey No. N32 	<ul style="list-style-type: none"> Slightly pungent (can cause the nose to sting) Heavier than air and will collect in ducts, drains and low lying areas, e.g. cellars At high concentrations, instant unconsciousness may occur followed by death
Asphyxiant	Nitrogen	Pewter No. N63 	<ul style="list-style-type: none"> Odourless At high concentrations almost instant unconsciousness may occur, followed by death No warning signs before unconsciousness occurs Cold Nitrogen is heavier than air Does not burn Largely Inert.
Asphyxiant	Argon	Peacock Blue No. T53 	<ul style="list-style-type: none"> Odourless At high concentrations almost instant unconsciousness may occur, followed by death No warning signs before unconsciousness occurs Argon is heavier than air Does not burn Inert
Asphyxiant	Helium	Brown No. X54 	<ul style="list-style-type: none"> Odourless At high concentrations, instant unconsciousness may occur, followed by death. DO NOT INHALE UNDER ANY CIRCUMSTANCES. No warning signs before unconsciousness occurs Lighter than air Does not burn Inert
Flammable Extremely hazardous	LPG	Silver, Grey No. N24 or Galvanised 	<ul style="list-style-type: none"> 'Stenched' (odourised) and has a distinctive odour Will ignite and burn instantly from a spark or piece of hot metal Heavier than air and will collect in ducts, drains etc., and low lying areas Fire and explosion hazard Highly flammable Eliminate all ignition sources
Flammable Extremely hazardous	Acetylene	Claret No. R55 	<ul style="list-style-type: none"> Distinctive garlic smell Fire and explosion hazards are greater than LPG but it is slightly lighter than air and less likely to collect in ducts and drains Requires minimal energy to ignite in air or oxygen DO NOT use with copper, high copper or brass alloys because copper materials form explosive compounds with Acetylene
Flammable Extremely hazardous	Hydrogen	Red No. R13 	<ul style="list-style-type: none"> Odourless Much lighter than air and will collect at the highest point in any enclosed space unless ventilated at high level Fire and explosion hazard Very low ignition energy Burns with an invisible flame
Oxidising Strongly supports and accelerates a flame or fire	Oxygen	Black No. N61 	<ul style="list-style-type: none"> Odourless Generally considered non-toxic at atmospheric pressure Will not burn, but supports and accelerates combustion Materials not normally considered combustible may be ignited by sparks in oxygen rich atmospheres No oil, grease or lubricants should come into contact with oxygen

Images above are intended for illustration purposes only. They neither reflect the size or shape of the cylinders, nor show the cylinder valve or guard (where fitted). This lists identifies primary hazards only. Other hazards may apply. Colour names refer to AS 2700.

Gas cylinder colour identification.

<p>Oxygen Industrial Grade Laser Grade High Purity Grade</p>  <p>Body: Black</p>	<p>Nitrogen Industrial Grade Laser Grade (Available in packs only) High Purity Grade VinAr</p>  <p>Body: Pewter</p>	<p>Carbon Dioxide Industrial Grade Laser Grade FOGG® High Purity Grade</p>  <p>Body: Green Grey</p>	<p>Argon Welding Grade High Purity Grade</p>  <p>Body: Peacock Blue</p>	<p>Helium High Purity Grade Laser Grade</p>  <p>Body: Brown</p>
<p>Acetylene Industrial Grade Instrument Grade</p>  <p>Body: Claret</p>	<p>Hydrogen Industrial Grade High Purity Grade</p>  <p>Body: Signal Red</p>	<p>Air Industrial Grade Instrument Grade</p>  <p>Band: Black Body: Pewter</p>	<p>ARGOSHIELD® 40 STAINSHIELD® SPECSHIELD® Copper</p>  <p>Band: Black Body: Peacock Blue</p>	<p>ARGOPLAS® 5 ARGOPLAS® 20 ARGOPLAS® 35</p>  <p>Band: Signal Red Body: Peacock Blue</p>
<p>ARGOSHIELD® 52 ARGOSHIELD® Heavy ARGOSHIELD® MCW ARGOSHIELD® Pipeline STAINSHIELD® Light</p>  <p>Band: Green Grey Body: Peacock Blue</p>	<p>ARGOSHIELD® Light ARGOSHIELD® Universal ARGOSHIELD® 54</p>  <p>Bands: Black, Green Grey Body: Peacock Blue</p>	<p>ARGOSHIELD® 100 STAINSHIELD® Heavy</p>  <p>Bands: Green Grey, Brown Body: Peacock Blue</p>	<p>STAINSHIELD® 69</p>  <p>Bands: Black, Brown Body: Peacock Blue</p>	<p>STAINSHIELD® 66</p>  <p>Bands: Signal Red, Green Grey Body: Peacock Blue</p>
<p>ALUSHIELD® Light ALUSHIELD® Universal</p>  <p>Band: Brown Body: Peacock Blue</p>	<p>ALUSHIELD® Heavy</p>  <p>Band: Peacock Blue Body: Brown</p>	<p>STAINSHIELD® Duplex</p>  <p>Bands: Pewter Body: Peacock Blue</p>	<p>STAINSHIELD® Pipeline</p>  <p>Bands: Green Grey, Peacock Blue Body: Brown</p>	
<p>Refrigerant R134a</p>  <p>Band: Aqua Body: Galvanised or White</p>	<p>Refrigerant R22</p>  <p>Band: Moss Green Body: Galvanised or White</p>	<p>Ammonia Refrigerant R717</p>  <p>Band: Slate Body: Galvanised or White</p>	<p>Refrigerant (Eductor tube fitted) R404A R407C R408A R409A R410A R416A Refrigerant R507</p>  <p>Bands: Brown Body: Galvanised or White</p>	

Notes

1. Colour names refer to AS2700
2. The colour coding/colours of cylinders filled in Australia comply with AS4484, colours of imported cylinders may differ.
3. Cylinder valves or guards not shown, except for Valve Protection Rings.
4. Refer to Australian Standard definitions
5. Images above are intended for illustrative purposes only. They neither reflect the size or shape of the cylinders.

<p>Nitrous Oxide</p>  <p>Body: Ultramarine</p>	<p>Methane (Imported)</p>  <p>Band: Signal Red Body: Silver Grey</p>	<p>Ethylene</p>  <p>Body: Violet</p>	<p>INSECTIGAS® D</p>  <p>Band: Golden Yellow Body: Green Grey</p>	<p>AGRIGAS® M (Methyl Bromide)(Imported)</p>  <p>Band: Signal Red Body: Blue</p>
<p>PESTIGAS®</p>  <p>Band: Moss Green Body: Green Grey</p>	<p>RIPEGAS®</p>  <p>Band: Violet Body: Sky Blue</p>	<p>VAPORMATE®</p>  <p>Band: Signal Red Body: Green Grey</p>	<p>DEODOURGAS®</p>  <p>Band: Deep Rose Body: Green Grey</p>	<p>BACTIGAS®</p>  <p>Bands: Signal Red, Deep Rose Body: Green Grey</p>
<p>MULTIMIX® CELLAMIX®</p>  <p>Band: Green Grey Body: Pewter</p>	<p>Sulphur Dioxide</p>  <p>Band: Golden Yellow Body: White or Galvanised</p>	<p>Carbon Monoxide (Imported)</p>  <p>Band: Golden Yellow Body: Signal Red</p>	<p>HANDIGAS® LPG Industrial Grade Gas withdrawal</p>  <p>Body: Silver Grey or Galvanised</p>	<p>HANDIGAS® LPG Liquid withdrawal</p>  <p>Band: Royal Blue Body: Silver Grey or Galvanised</p>
<p>LASERMIX® 321</p>  <p>Bands: Green Grey, Brown Body: Pewter</p>	<p>LASERMIX® 320 LASERMIX® 331 LASERMIX® 332 LASERMIX® 341 LASERMIX® 344</p>  <p>Bands: Green Grey, Pewter Body: Brown</p>	<p>LASERMIX® 690 (Imported)</p>  <p>Bands: Signal Red, Golden Yellow Body: Pink</p>		

HiQ® Scientific Gas Mixtures (Examples for Australia)

<p>Flammable</p> <p>2 Component Mixture Eg: Hydrogen in Helium</p>  <p>Band: Signal Red Body: Brown</p>	<p>Toxic</p> <p>2 Component Mixture Eg: Sulphur Dioxide in Nitrogen</p>  <p>Band: Golden Yellow Body: Pewter</p>	<p>Toxic and Flammable</p> <p>2 Component Mixture Eg: Methanol in Carbon Dioxide</p>  <p>Bands: Golden Yellow, Signal Red Body: Green Grey</p>	<p>AS 4484 Specified Gases</p> <p>4 Component Mixture Eg: Hydrogen, Nitrogen, Methane in Argon</p>  <p>Bands: Silver Grey, Pewter, Signal Red Body: Peacock Blue</p>	<p>Hydrocarbon Mixture</p> <p>Eg: Ethane, Ethylene, Carbon Dioxide, Nitrogen in Methane</p>  <p>Bands: Silver Grey, Violet, Green Grey, Pewter Body: Silver Grey</p>
<p>Non-Toxic, Non-flammable</p> <p>Multi-component Mixture Eg: 25ppm H₂S, 100ppm CO, 25% CH₄, 18% O₂ in Nitrogen</p>  <p>Bands: Brown, Gold Body: Pewter</p>	<p>Oxidising</p> <p>Multi-component Mixture Eg: 1% Carbon Dioxide, 1% Helium, 1% Nitrogen, 25% Oxygen in Argon</p>  <p>Bands: Black, Gold Body: Peacock Blue</p>	<p>Notes Body colour denotes balance gas or major component, Band colour/s denote minor components or mixture characteristics.</p> <p>Gas Mixtures Band Colour Legend</p> <ul style="list-style-type: none">  Gold: Multi-component  Brown: Non-toxic, non-flammable  Black: Oxidising or oxygen component  Silver: Hydrocarbons  Signal Red: Flammable  Golden Yellow: Toxic 		

Medical gas cylinder colour identification.

INHALO® O_2  Body: White	Oxygen O_2  Body: White	Nitrous oxide N_2O  Band: Ultramarine Body: White	ENTONOX® N_2O/O_2  Band: Ultramarine and White Body: White	Air  Band: Black and White Body: White
Carbon dioxide CO_2  Band: Green Grey Body: White	Carbon dioxide CO_2 Liquid withdrawal  Band: Green Grey Body: White	CARBOGEN CO_2/O_2  Band: Green Grey and White Body: White	Helium He  Band: Brown Body: White	HELIOX He/O_2  Band: Brown and White Body: White

For information regarding the transport of medical cylinders in use, please refer to the Home Oxygen Therapy Patient Information Booklet available from BOC, or contact BOC Healthcare on 1800 050 999.

Notes

1. Colour names refer to AS2700
2. The colour coding/colours of cylinders filled in Australia comply with AS4484, colours of imported cylinders may differ.
3. Refer to Australian Standard definitions
4. Images above are intended for illustration purposes only. They neither reflect the size or shape of the cylinders, nor show the cylinder valve or guard (where fitted).

About your cylinders and valves.

High Pressure Cylinders

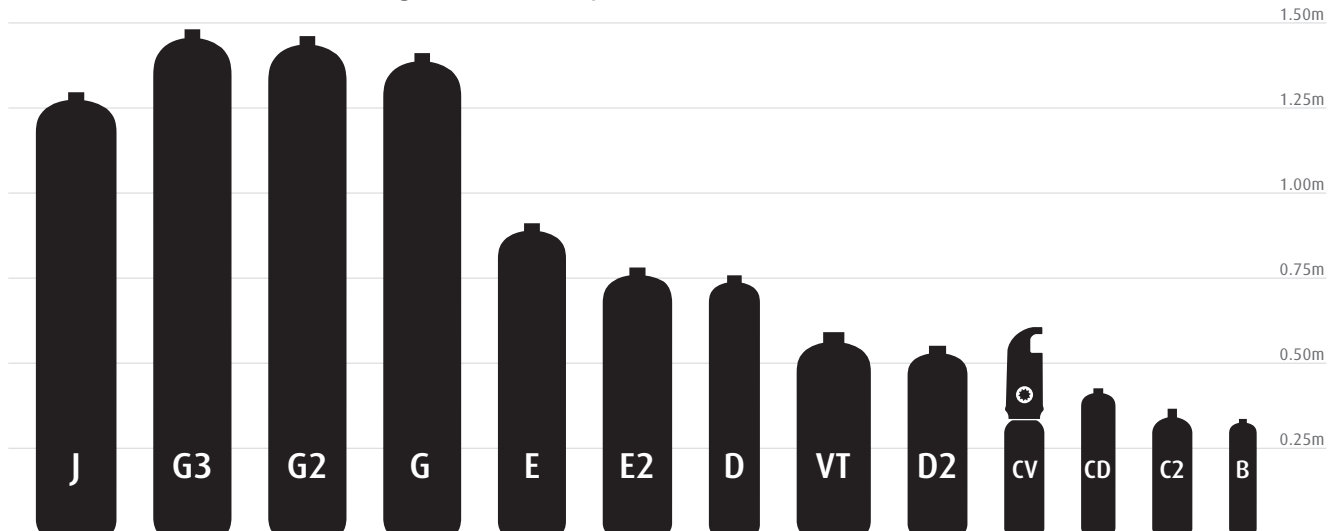

Image is for illustrative purposes only.

Design and construction of gas cylinders

BOC gas cylinders are designed and constructed in accordance with International and Australian Standards as applicable. These Standards define the cylinders:

- Material
- Method of manufacture
- Test pressure
- Maximum permissible filled pressure and
- Method of periodic inspection

Compressed gas cylinder sizes

Single cylinders

BOC offers a wide range of single high pressure cylinders suitable for small volumes of gas, available in many sizes and pressures.

BOC cylinder sizes are denoted by a letter code. The gas content of cylinders is measured in cubic metres, litres or kilograms. If volume unit is given, it refers to standard temperature of 15°C and pressure of 101.3kPa.

Not all cylinder sizes shown are available for each product, please consult BOC on 131 262 for details.

Manifolded Cylinder Pack (MCP, Pack or Bundle)

Cylinders are normally used individually or collectively. A Manifolded Cylinder Pack describes cylinders used collectively, interconnected by a manifold – a portable frame. These are often bundled in packs of 4, 9 or 15 cylinders for onshore products and 16 or 64 cylinders for offshore products. Collective use of cylinders is necessary for customers who require larger quantities of gas.

Where customers do not have adequate handling facilities for on and off loading from the delivery vehicle, BOC can deliver on vehicles with suitable manual handling equipment.



Manifolded Cylinder Pack

1 Contents Pressure Indicator

NEVER remove individual cylinders from Manifolded Cylinder Packs.

These are designed and supplied as integral units with gas content labels to suit. Removal of individual cylinders renders the label contents incorrect and may have safety implications.

Maintenance and testing of gas cylinders

In most cases BOC is the owner of the cylinder. As the owner, BOC is responsible for complying with the statutory requirements relating to maintenance and periodic testing of cylinders.

Australian Standard AS 2030 details the statutory requirements in respect to design, manufacture, inspection and filling.

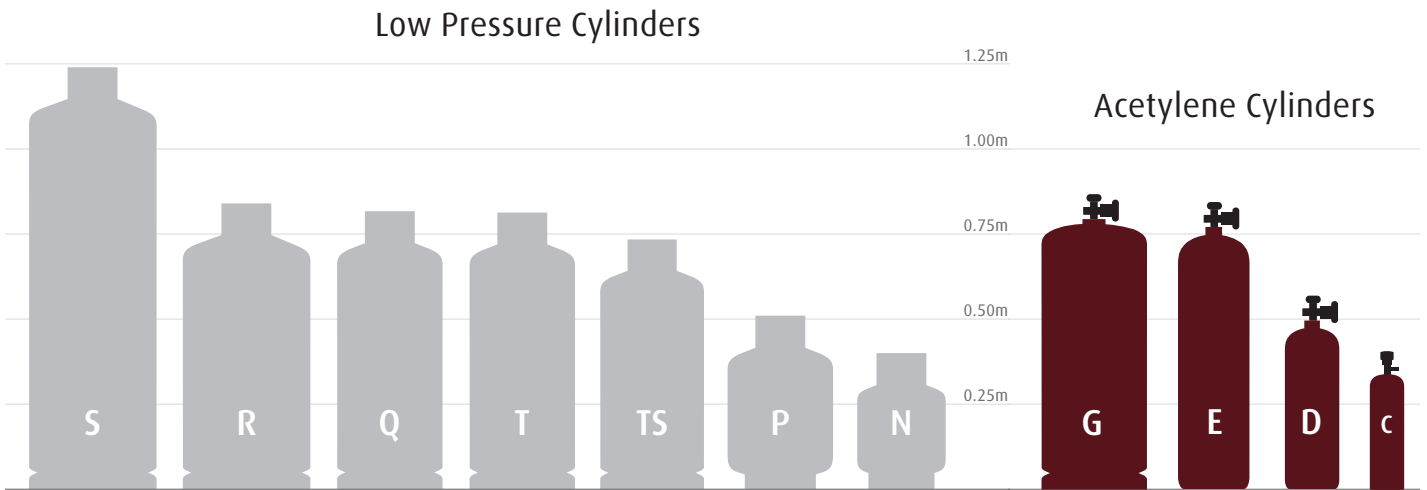

Image is for illustrative purposes only.

Cylinder contents identification

All BOC cylinders are labelled in accordance with the requirements of the Australian Dangerous Goods Code (ADGC) for transport of dangerous goods by road and rail.

Cylinder labels identify the gas contents of the cylinder and provide basic safety information (see page 6).

NEVER use any cylinder or pack unless it is clearly labelled and can be positively identified.

NEVER repaint or obscure a cylinder label, even if the cylinder is rusty, dirty or damaged. This can result in unsafe situations.

NEVER apply any unauthorised labels or markings to cylinders, unless advised by BOC to identify faulty cylinders.



Permanent gas seamless cylinder (Oxygen)

Markings on a Permanent Gas Seamless Cylinder

- Owner Stamp Mark
- Weight
- Serial No.
- Test pressure of shell
- Manufacturer's stamp
- Test date (retest date)
- Specification
- Water capacity



Welded steel cylinder (Acetylene)

Markings on Welded Steel Cylinders

- Owner Stamp Mark
- Weight empty with mass embossed by BOC
- Serial No.
- Test pressure of shell
- Manufacturer's stamp
- Test date (retest date)
- Porous mass manufacturer/type
- BOC – Inspector's approval stamp
- Water capacity



Welded aluminium cylinder

Markings on Welded Aluminium Cylinder

- Owner Stamp Mark
- Empty weight & Tare weight
- Serial No.
- Test pressure of shell
- Manufacturer's stamp
- Test date (retest date)
- Specification
- Water capacity

Typical permanent identification marks on cylinders

For seamless cylinders, permanent identification markings are usually found on the shoulder or base of the cylinders. For fabricated cylinders, markings are found on the valve protection ring (VPR).

It is dangerous to change the contents or external colour of a cylinder

NEVER change a cylinder's contents from what was otherwise intended

NEVER repaint a cylinder

NEVER change a cylinder's markings or identification

Cylinder valves

All BOC cylinders are fitted with a valve. The valve **MUST NOT** be tampered with or removed by anyone other than a BOC certified and MP48 Certified Gas Cylinder Test Station.

Removing fittings under pressure may result in serious personal injury as fittings may be ejected at high velocity.

Each valve outlet is specially threaded to receive commercially available pressure regulators. They can be obtained from BOC Gas & Gear centres and agents.

Regulators are first screwed to the cylinder valve outlet by hand and then tightened using the regulator multi-spanner (inlet spigot).



Typical single stage regulator

- 1 Regulator Outlet Connection
- 2 Cylinder Valve
- 3 Inlet Spigot (regulator)
- 4 Regulator Multi-Spanner (Inlet Spigot)



Important note:
Shut off the valve and remove the regulator when the cylinder is not in use.

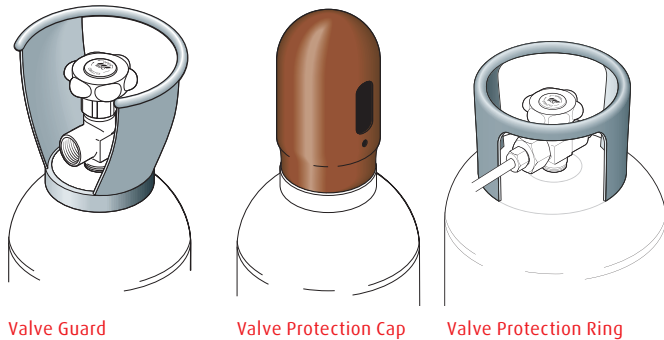

Valve Guard

Valve Protection Cap

Valve Protection Ring

Valve guards, valve protection caps and valve protection rings

Some cylinders are fitted with valve guards or valve protection caps.

DO NOT remove valve guards or valve protection rings.

DO replace valve protection caps whenever the cylinder is not secured or not in use.

DO return your cylinder to BOC with the valve in the closed position and with the protection cap on (refer to Opening or Closing cylinder valves).

Valve outlets threaded

For safety reasons, flammable gases and non-flammable gases have their cylinder valve outlets threaded opposite hand. This prevents the connection of the incorrect regulator to cylinder valve outlets.

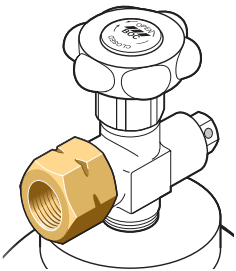

Left-hand thread - Notched

Valve outlets for flammable gases are screwed **LEFT-HAND** (anti-clockwise to tighten). Identifiable by its notched appearance or 'LH' marking near the valve outlet.

Cylinders containing flammable gases like acetylene, hydrogen, propane and mixtures containing fuel gas all have left-hand threads.

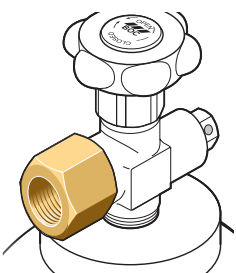

Right-hand thread - Plain

Valve outlets for non-flammable gases are screwed **RIGHT-HAND** (clockwise to tighten).

Cylinders containing non-flammable/non-toxic gases all have conventional right-hand threads. Non-flammable gases can be oxidising e.g. oxygen; or non-flammable, non-toxic e.g. nitrogen, argon and air.

The only exception to this rule are cylinders used on forklift trucks. These cylinders have **right-hand** thread valve outlets.

As an additional safety precaution, in 2006 air and nitrogen cylinder valve outlet sizes and threads were differentiated from oxygen to prevent the:

- Incorrect connection of an oxygen cylinder to applications where an inert gas is required.
- Incorrect connection of an oxygen cylinder to applications where only air (21%) oxygen is required.

DO NOT connect incompatible regulators; this could lead to valve and regulator thread damage, and an uncontrolled release of gas.

DO NOT over-tighten or use excessive force to connect equipment.

DO call BOC for a replacement cylinder if the regulator does not connect properly.

Operating a cylinder valve

OPEN by turning the handwheel or cylinder valve key anti-clockwise. Only use reasonable force.

CLOSE by turning the handwheel or cylinder valve key clockwise. Only use reasonable force.

NEVER use force when opening or closing valves.

When in use, cylinder valves used in the fully open position may become stuck in this open position. To prevent this ensure that the handwheel or cylinder valve key is turned back half a turn.

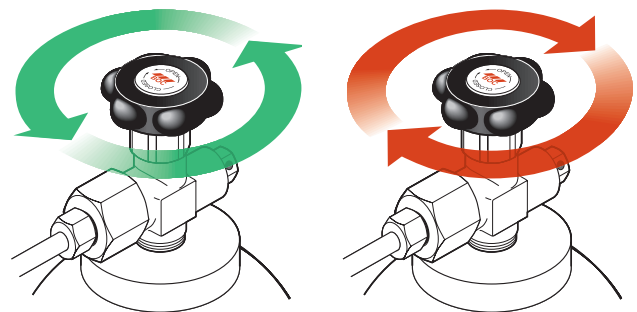

Open

Close

In the case of a key operated cylinder valve, turn the rectangular key **ANTICLOCKWISE** using the cylinder valve key (see below). Cylinder valve keys are available from BOC Gas & Gear centres.

Nearly all cylinder valves are fitted with and operated by handwheels so the need for a cylinder valve key is rare.

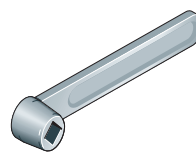

Cylinder valve key

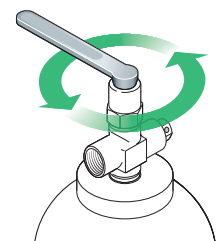

Turn anticlockwise to open key operative valve. (Close not shown).

Cylinder valves with an integrated regulator (applicable currently to 300 bar filled cylinders and MCPs e.g. nitrogen, shielding gases)

BOC cylinders are filled to a variety of pressures e.g. 137, 163, 175 and 200 bar. The largest capacity cylinders are filled to 300 bar to allow more gas to be filled at a higher pressure in an equivalent sized cylinder. Controlling the pressure within these 300 bar cylinders to operating level (i.e. 200 bar or less) is an integral pressure regulator. The cylinder valve complete with this regulator is known as a Pressure Regulating Valve (PRV).

BOC's 300 bar cylinder valves come fitted with PRVs. This PRV is typically set to a maximum output of 60-80 bar pressure at any given time. Therefore an existing regulator of 200 bar or less can be used with these 300 bar cylinders.

As a result of the PRV, when a 200 bar regulator is fitted, the gauge on this 200 bar regulator will only display a 60/80 bar inlet pressure even though the cylinder has actually been filled to 300 bar.

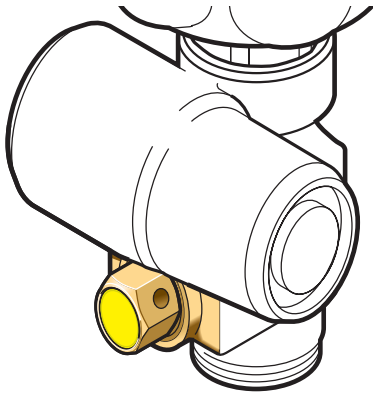

Burst disc

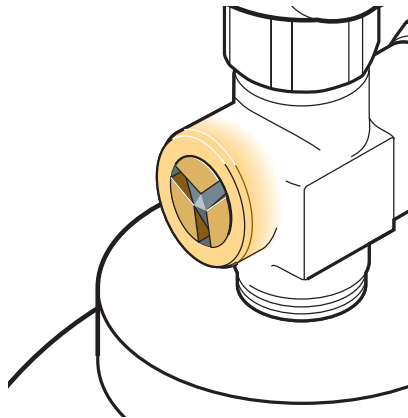

Fusible plug

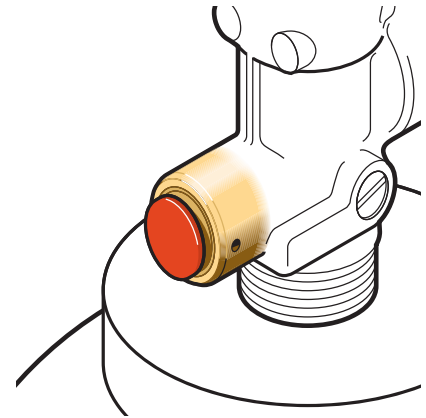

Pressure relief valves

The only exception to this are the Laser Manifolded Cylinder Packs (MCPs) which come fitted with a high flow rate 300 bar regulator. This regulates the outlet of the MCP to the selected outlet pressure which is adjustable from 0 to 35 bar.

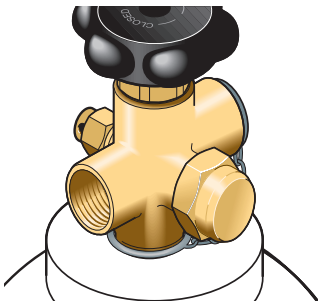

300 bar filled cylinder fitted with a cylinder valve featuring an integrated regulator

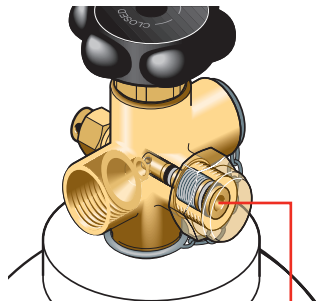

Cross section view displaying the tiny integrated regulator on the right side

Handy hints for identifying the cylinder contents pressure

- 300 bar MCPs have a centrally mounted pressure gauge which indicates the MCP's contents pressure (approx. 300 bar when full).
- For cylinders the contents label indicates the pressure when full. As gas is consumed, the regulator inlet pressure gauge (if fitted) will show the cylinder contents pressure.

To convert from MPa/KPa/psi to bar refer to the pressure cross reference chart in the glossary. Alternatively contact BOC on 131 262.

Note: Gauges are to be used for indication purposes only.

Pressure relief devices

Most cylinders or manifolded cylinder packs are fitted with a relief device. In a situation where excess pressure is encountered, this is designed to discharge cylinder contents either completely or only discharge the excess pressure. Discharge of a pressure relief device

will be accompanied by a high pitched noise and a jet of gas at high speed. There are three types of commonly used pressure relief devices:

- Burst disc (most common)
- Fusible plug (e.g. acetylene)
- Pressure relief valve (e.g. LPG)

Burst disc

In the event of overpressure, this is designed to burst, leaving an open passage for gas contents to escape completely.

e.g. Carbon Dioxide (CO₂) cylinders are fitted with a burst disc which operates at approximately 207 bar and is fitted on the cylinder valve.

Fusible plug

This is designed to melt when the cylinder is exposed to high temperatures and will completely release the cylinder contents.

e.g. Acetylene cylinders are fitted with fusible plugs which melt at approximately 100°C.

Pressure relief valves

This valve is designed to relieve excess pressure and close again after relieving the excess pressure.

e.g. BOC Handigas® (LPG) cylinders are fitted with pressure relief valves which operate at approximately 26 bar.

Safety tip

Cylinders can be dangerous and can release contents given the right circumstances. BOC recommends proper Personal Protective Equipment (PPE) be worn at all times, consult your Occupational Health & Safety officer or BOC on 131 262 for further details.

Storage guidelines appropriate to the gas specified must be adhered to. In the event your cylinder activates any of these devices contact Emergency Services on 000 and then BOC on 1800 653 572.

Ordering, transport and handling of cylinders.



Vehicle explosion caused by a leaking flammable gas cylinder



Damage from inappropriately stored and unrestrained cylinders in a vehicle, which stopped suddenly. Please note: Image is for illustrative purposes only. Cylinder colours do not comply with Australian Standards.

Ordering gas

Take care when ordering gas. Specify the:

- Gas name (in full)
- BOC account number (Ship to or delivery account)
- BOC Gas Code
- Cylinder Size

For example:

Gas Specifics	Example (Oxygen)
Gas Name	Compressed Industrial Oxygen
Grade (purity)	99.5%
BOC Gas Code	020
BOC Cylinder Size Code	G

Receipt of cylinders

- Many gases cannot be seen; so the primary means of identification of a cylinder's contents is the label.
- Only gas cylinders with clearly legible shoulder or body labels are to be used.
- If this is not the case, do not accept it but make arrangements to return and replace the cylinder.
- Also check that what you ordered is what is stated on the label and clearly sign the delivery docket.

Transportation

When transporting small gas cylinders in a vehicle, VENTILATION is the key to reducing the risk of a fire, explosion and/or asphyxiation.

- **DO** use an open vehicle such as a utility, as this provides the best ventilation and avoids the risks of gas accumulation.

- If you are transporting the cylinder inside a trade vehicle:
 - Keep the cylinder in a purpose built sealed compartment or cabinet that provides adequate ventilation of any leaking gas to the outside of the vehicle.
 - A side-mounted sealed compartment with its own door, externally accessed and ventilated to the outside of the vehicle is best practice.
- **DO arrange for delivery of cylinders.** This is the safest option. Goods delivered by BOC will be loaded, restrained, transported and off loaded in accordance with legislative requirements.

If you must transport cylinders yourself:

- **DO find out about transporting cylinders prior to your purchase.** Confirm the requirements for the transportation and handling of goods being collected with BOC's Customer Service Centre prior to making collection.
- **DO transport cylinders in an open vehicle.** BOC does not condone the transport or storage of flammable gas (e.g. Acetylene, LPG) cylinders in enclosed vehicles (unless the vehicle is fitted with a purpose built sealed compartment that provides adequate ventilation of any leaking gas to the outside of the vehicle). There have been several violent vehicle explosions as a result of transporting and storing flammable gas cylinders in enclosed vehicles. Fatalities have occurred.
- **DO transport cylinders properly restrained and in an upright position.** Cylinders and cylinder packs are heavy and need to be properly loaded and restrained prior to despatch to prevent them working loose and becoming a hazard to others.
- **DO close the cylinder valve and disconnect regulators or equipment (e.g. hoses and torch) prior to transport.**
- **DO regularly check for leaks.**
- **DO remove cylinders from the vehicle immediately upon arrival at your destination.**
- **DO check that cylinders are properly labelled and have not been tampered with.**



Example of correct positioning and restraining of gas cylinders



The Dangerous Goods Division (Class) is normally clearly marked on the product label

Transporting gas cylinders

For information regarding the transport of medical cylinders in use, please refer to the Home Oxygen Therapy Patient Information Booklet available from BOC, or contact BOC Healthcare on 1800 050 999.

Hazards

Compressed and liquefied gases are potentially hazardous for the following reasons:

- Some gases are very flammable and a leakage can create an explosive atmosphere in an enclosed vehicle.
- Oxygen enrichment causes material to ignite easily and will increase the intensity of a fire. Any oxidizing gas, e.g. Nitrous Oxide (laughing gas) has similar properties.
- Inert (Non-Flammable/Non-Toxic) gases can cause oxygen deficiency and asphyxiation.
- Toxic or corrosive gases are hazardous to health.
- The gas pressure is high and a ruptured cylinder or valve can cause serious injury or damage.
- Unsecured gas cylinders may cause injury when projected out of place in cases of accidents or rapid traffic movements.
- Cryogenic liquids are very cold and can cause cold skin burns and metal brittle fracture. Cryogenic liquid vaporises to create large amounts of gas.
- When a liquefied gas is released, it vaporises and creates large amounts of gas.
- Heat may cause any safety device fitted to activate and release the gas contents of the cylinder.

Information on the hazards can be found on the cylinder label, and in the Safety Data Sheet that is freely available from BOC.

Risks - Dangerous Goods Divisions

- Division 2.1 Flammables (e.g. Acetylene, Ethylene, Hydrogen, LPG) – may cause flammable or explosive atmospheres in the vehicle compartment.
- Division 2.2 Inerts (e.g. Nitrogen, Argon, Shielding Gases) – may cause an asphyxiating atmosphere leading to drowsiness, unconsciousness and death.
- Division 2.3 Toxic (e.g. Sulphur Dioxide) may lead to a toxic atmosphere which is hazardous to health by breathing and/or skin contact.
- Division 2.2/5.1 Oxidising (e.g. Oxygen, Nitrous Oxide) – may cause some materials to easily ignite (e.g. oil) and will increase intensity of a fire.
- Division 9 – Dry Ice (Solid CO₂) and Division 2.2 Refrigerated Liquids (e.g. Nitrogen, Argon, Oxygen) – evaporate to large volumes of inert gas (see Division 2.2 Inerts).

Note: The Dangerous Goods Division (Class) is normally clearly marked on the product label.

The above information is sourced from the brochure *Transporting gas cylinders or cryogenic liquid receptacles in vehicles* and is reproduced with the permission of ANZIGA.

Carrying a load safely

Choosing a vehicle wisely

The vehicle must be suitable for the size and type of load.

The vehicle must be equipped to conform to the requirements of the transport of dangerous goods regulations.

The maximum payload of the vehicle must not be exceeded.

Positioning the load correctly

The load must be correctly positioned on the vehicle to maintain its stability.

Acetylene, LPG and Liquefied gas cylinders must always be transported in an upright position.

Using suitable restraint equipment

Unrestrained or inadequately restrained cylinders are heavy and may cause injury or damage to vehicles and can lead to a violent cylinder rupture in transport. When transporting cylinders always ensure they are properly restrained to avoid movement.

Every load must be restrained to prevent unacceptable movement during all expected conditions and operation

The load restraint equipment and the vehicle body and attachments must be strong enough for each type of load carried, and must be in good working condition.

The above information is sourced from ANZIGA guideline *Transporting gas cylinders and other gas products* and is reproduced with the permission of ANZIGA.

Restraining gas cylinders for transport in commercial or passenger vehicles under 2.5 tonne.



Example of the potential consequences of transporting a gas cylinder within an enclosed vehicle

General guidelines

Precautions

The safest and recommended method for transporting cylinders (e.g. gas cylinders and cryogenic receptacles) is by using the transport services provided by BOC. Occasionally, there may be a need to use other transport methods in which case it is then essential to follow safety instructions for full and empty cylinders:

- Restrain all cylinders from moving during transport (consider the forces generated in a traffic accident)
- Limit the number of cylinders to be transported.
- Use open vehicles or trailers in preference to any enclosed vehicles or trailers. DO NOT cover the gas cylinders with a tarpaulin.
- Ensure that the contents label on the cylinder can be clearly read.
- NEVER drop cylinders or submit them to shock. This is an extremely hazardous practice which may result in serious injury.
- Where possible, use mechanical lifting devices and trolleys to move cylinders.
- Wear safety shoes or boots, safety glasses or goggles, and leather protective gloves when handling cylinders.
- Smoking is strictly forbidden when loading, transporting, and unloading any gas cylinder.

The above information is sourced from the brochure *Transporting gas cylinders or cryogenic liquid receptacles in vehicles* and is reproduced with the permission of ANZIGA.

For non-flammable, non-toxic gas loads:

- An open vehicle with sides is preferable.
- Panel vans and pantechs may be used provided the driver's cab is separate from the load carrying area. **This means that the driver's cab and load carrying areas are separately ventilated.**

For flammable or toxic gases:

- The vehicle must have a flat bed with sides, a tailboard, and a cab which is separately ventilated from the load carrying area. Flammable gases may be carried in closed compartments separated from the driver provided there is sufficient ventilation to prevent the build-up of a dangerous atmosphere. In Australia, curtain sided vehicles are deemed to be closed compartments.
- Toxic gas cylinders should always be restrained in a well-ventilated compartment separated from the driver.
- When transporting toxic gas cylinders, ensure that the valve outlet cap and protective cap are securely fitted (see page 14).
- Flat bed vehicles without sides must not be used, except where the cylinders are conveyed in approved pallets.
- Vehicles conveying drums over 300 kg need not have sides provided the drums are chocked, roped and sheeted.
- NEVER transport flammable gas cylinders lying down.

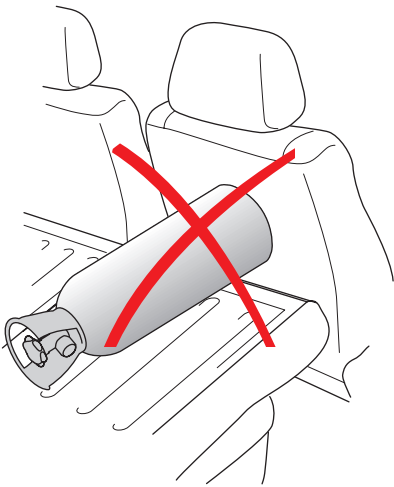

DO NOT carry loose gas cylinders in the rear



DO NOT place cylinders on seats



Purpose built sealed compartment

Enclosed Vehicles

Ventilation is the key to reducing the risk of a fire or explosion.

Trades Vehicles

- Use an open vehicle such as a utility as this provides the best ventilation and avoids the risks of gas accumulation.
- If you are transporting the gas cylinder inside a trade vehicle:
 - keep the gas cylinder in a purpose built sealed compartment or cabinet that provides adequate ventilation of any leaking gas to the outside of the vehicle;
 - A side-mounted sealed compartment with its own door, ventilated externally is best practice.
- DO close the gas cylinder valve and disconnect the regulator, hoses and torch prior to transport;
- DO regularly check for leaks from valves;
- DO secure the gas cylinders and keep them upright;
- DO ensure the vehicle is well ventilated;
- DO unload the cylinder from inside the vehicle immediately on reaching your destination, unless the vehicle has a purpose built sealed compartment vented externally.

Passenger Vehicles

DO NOT transport gas cylinders in the passenger compartment of any vehicle due to the difficulty of providing appropriate load restraint.

Transporting gas cylinders inside the driver or passenger compartment of passenger cars is extremely dangerous and could cause an explosion, fire, exposure to toxic gas, or asphyxiation.

Note: For information regarding the transport of medical cylinders in use, please refer to the Home Oxygen Therapy Patient Information Booklet available from BOC, or contact BOC Healthcare on 1800 050 999.

Enclosed vehicles used to continually transport gas cylinders

When cylinders are continually transported in enclosed vehicles (such as ambulances, service vans with welding equipment, etc.) the following is recommended:

- A permanent system should be in place to secure the gas cylinders (and cryogenic liquid receptacles);
- Gas cylinders should be carried in a side mounted sealed compartment with its own door, ventilated externally.

Loading a cylinder into an enclosed vehicle

Before loading a cylinder into an enclosed vehicle:

- Tighten (do not overtighten) the cylinder valves and check that they are properly closed;
- Check carefully for gas leakage. NEVER transport a cylinder, if a leak has been detected during loading;
- Check that the valve outlet protection cap is fitted where required. NEVER remove any valve protection device (if fitted) during transport;
- NEVER transport gas cylinders with a regulator or any other equipment attached.

When loading gas cylinders at a gas supplier's site or shop, the personnel responsible for the sale and/or loading the cylinders should provide the safety instructions on loading and transport to the driver.

Gas suppliers may refuse to load certain vehicles based on their assessment of the risk associated with the product to be loaded, the particular vehicle and the method of loading and restraining the product.

The above information is sourced from the brochure *Transporting gas cylinders or cryogenic liquid receptacles in vehicles* and is reproduced with the permission of ANZIGA.

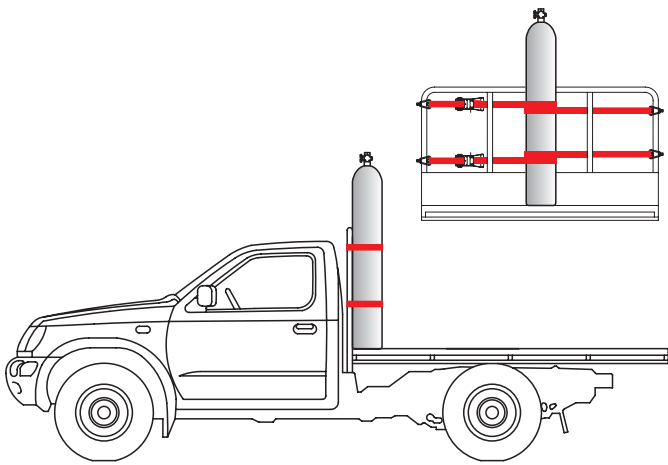

Transporting cylinders upright

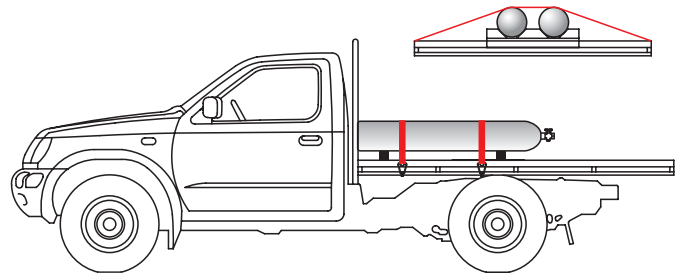

Transporting cylinder lying down. (Note: NEVER transport LPG cylinders, Dissolved Acetylene cylinders or liquefied gas cylinders lying down)

Transporting cylinders in a van

- DO NOT transport gas cylinders in the passenger compartment of a van
- DO NOT carry loose gas cylinders in the rear load compartment of a van
- Vans are only suitable for the transport of gas cylinders if they are fitted with a purpose built sealed compartment or cabinet that provides adequate ventilation of any leaking gas to the outside of the vehicle

Transporting cylinders in utilities and box trailers

If you transport cylinders in a style-side or drop-side utility, **DO NOT** place them in the cab.

Transporting cylinders upright

Restrain cylinders by lashing them to the vehicle body using webbing straps or containing them in a purpose-built frame.

If transporting cylinders upright against a headboard:

- The total weight of the cylinders should not exceed 250 kg.
- Apply at least two horizontal webbing straps, as shown above.

Webbing straps must be at least 38mm wide with a minimum lashing capacity of 1000 kg.

DO NOT use the following materials for restraining cylinders:

- Elastic straps
- Rope
- Duct tape

Transporting cylinders lying down

If transporting cylinders lying down:

- Place the cylinders lengthwise on the deck.
- Place the cylinders on chocks to prevent them rolling sideways and to provide more grip to stop them sliding.

- Position the cylinders with the valves facing rearwards, with the base blocked against the headboard or another strong part of the load.
- Apply at least two tie-down straps (as shown above).

The above information is sourced from ANZIGA Guideline 4 *Restraining individual gas cylinders and other gas products for transport* and is reproduced with the permission of ANZIGA.

- **NEVER** transport LPG cylinders, Dissolved Acetylene cylinders and liquefied gas cylinders such as Carbon Dioxide lying down.

Emergencies and accidents

- If a gas leak occurs during the transportation of gas cylinders, where practical, stop and park the vehicle as far away as possible from other vehicles or people. Leave the vehicle and call **1800 653 572 BOC Emergency Response Line** for specialist advice.
- In the event of a fire or any other emergency, call the fire brigade on **000** and advise them of the details of your load.
- Call the emergency services should the transport vehicle be involved in a road accident whilst carrying cylinders and advise them of the details of your load, and your location.

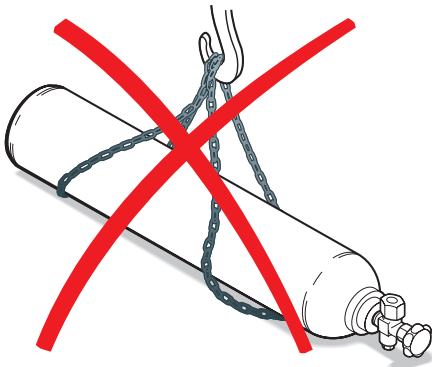

DO NOT use chains or slings to move cylinders



Lift cylinder packs by forklift or by crane.



Ensure cylinder valve is closed before moving or disconnecting equipment

Lifting Manifolder Cylinder Packs (MCPs)

MCPs (weight 1.5 tonnes or higher) can be lifted either by crane (using the lugs located on pack) or forklift truck. It is in the customer's interest to check that their vehicles and lifting devices are of adequate load capacity before ordering cylinder packs. In particular that the tynes of forklifts are sufficiently long. If side access is required for forklifts, longer than standard (1070mm long) tynes are required, with a maximum thickness of 50mm or less. If the stirrups in any of the forklift tyne pockets are damaged then forklifts must not be used to lift them.

Lifting cylinders

- Cylinders must be secured for lifting. For steel cylinders, magnets, slings and chains are not effective as they may slip. For aluminium cylinders, magnets will not work and chains may cause damage.
- Cylinders, being round, are inherently difficult to secure and handle. There is a tendency for them to slide or slip away when lifting from their initial position (whether vertical or horizontal).
- DO NOT attempt to catch a falling cylinder. They are designed to withstand such an impact. Let it fall and move away from the direction of impact. Most cylinder handling injuries occur when people try to prevent cylinders from falling.
- NEVER roll a cylinder horizontally along the ground as this may cause the valve hand wheel to become damaged or open if the cylinder valve handle strikes something. If the surface is rough it will damage the coloured paintwork identification of the cylinder.
- The use of cylinder trolleys is preferable for large cylinders (>12 kg).
- NEVER lift a cylinder by the cylinder valve or valve handwheel.

Moving cylinders – manual risks to be aware of when handling cylinders

- Always close the cylinder valve before relocating a cylinder.
- When using a cylinder trolley to move cylinders, make sure cylinders are properly secured, and the cylinder valves are closed.
- NEVER transport cylinders with the pressure regulator and hose attached unless on a purpose designed trolley or carrier complete with webbing retainers.
- NEVER use cylinders in a storage compound. Cylinders should always be removed from the storage compound, transported by a cylinder trolley (see next page) and positioned adjacent to the workstation to enable immediate access to the cylinder valve and regulator.
- Once in place, the cylinder must be secured by cylinder wall brackets, before ancillary equipment is connected (see next page).

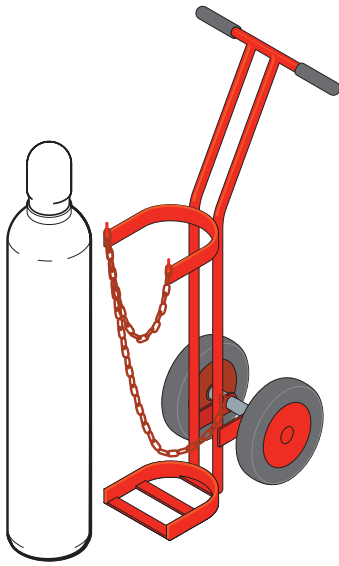

Cylinder trolley

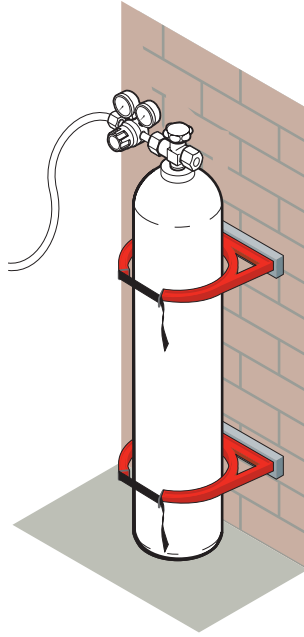

Cylinder wall brackets

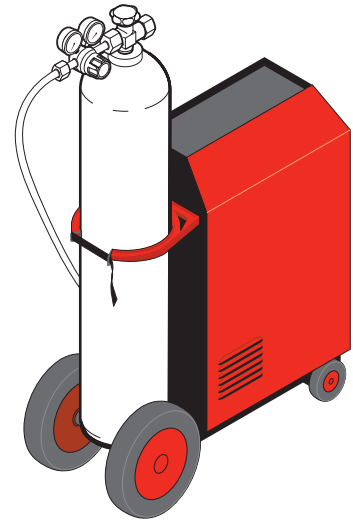

Cylinder bracket on welding machine

Handling gas cylinders — general safety

DO use mechanical aids (ramps, trolleys, forklifts, scissor lifts) in preference to direct manual handling of cylinders.

DO remove any connected equipment (e.g. regulator) AND refit any supplied valve protection cap and/or valve outlet gas tight cap/plug prior to moving cylinders.

DO ensure cylinders are properly restrained to mechanical lifting/handling devices prior to movement.

DO familiarise yourself with and observe appropriate safe lifting techniques/postures prior to manually handling heavy or large gas cylinders.

DO assess the load weight and dimensions before attempting any lift.

DO use suitable personal protective equipment (PPE) – wear safety footwear and leather gloves to protect against falling/ slipping cylinders crushing hands or feet during moving.

DO ensure a positive hand grip prior to commencing a manual lift.

DO ensure proper coordination of the lift and that the load is equally shared when attempting a two-person lift.

DO note environmental conditions prior to handling cylinders – wet, hot or cold cylinders may diminish the quality of hand grip and footing may be compromised.

DO NOT bear-hug cylinders to effect a lift.

DO NOT lift or lower cylinders where the operators hands are above shoulder height or below mid-thigh height.

DO NOT edge-roll cylinders up or down steps of 250 mm or higher.

DO NOT edge-roll cylinders over discontinuous or soft surfaces.

DO NOT edge-roll more than one cylinder at a time

DO NOT attempt to catch or restrain a falling cylinder.

DO NOT attempt to handle cylinders if you are fatigued, physically compromised or under the adverse influence of medication or alcohol.

DO NOT drop cylinders as a method of transfer – this may seriously damage the cylinder or its valve, resulting in their failure and product release.

The above information is sourced from ANZIGA document *Manual Handling Gas Cylinders* and is reproduced with the permission of ANZIGA.

Storing your cylinders safely.

Storage locations

- **Small** quantities of cylinders may be stored in a variety of locations, provided Dangerous Goods and local government regulations and the principles given in the following paragraphs are followed.
- **Larger** quantities of cylinders should be kept in a purpose-designed store or storage area, following the same principles.

Ideal storage

Full or empty compressed gas cylinders should be stored

- In a well ventilated area
- Preferably in the open
- With some weather protection

The area on which cylinders are stored must be well-drained to prevent corrosion of cylinder bases. The location must be free from the risk of fire and well away from sources of heat or ignition.

Store cylinders standing vertically and restrain them

- 1 It is recommended to store cylinders vertically.
- 2 Vertically stored cylinders must always be restrained or under your direct control. When standing or rotating and 'walking' cylinders about their vertical axis, be aware of the hazards of uneven sloping, slippery and unstable surfaces as well as loose surfaces. Restrain cylinders to prevent them falling as unrestrained cylinders are a potential hazard to users and passers-by should they inadvertently bump them.
- 3 Acetylene and LPG must never be stacked horizontally in storage or in use.
- 4 Whenever possible use a cylinder trolley for transporting cylinders higher than one's waist height.

Plan for emergencies

Ensure free and clear access to cylinder storage areas.

All persons with a responsibility for storage or use of gas cylinders must be familiar with the hazards and emergency procedures. Store layouts and emergency procedures need to be structured accordingly and to cater for possible incidents.

Cylinders should be stored in dedicated cylinder-only areas.

You must not store any other products in a cylinder store, particularly oil, paint or corrosive liquids.

Rotate your stock

Your storage arrangements should ensure adequate turn around of stock. DO NOT store empty cylinders longer than necessary; return them to BOC as soon as possible. This applies particularly to cylinders which contain flammable or toxic gases.

Wear the correct Personal Protective Equipment (PPE)

All persons handling gas cylinders must wear the correct PPE. Safety shoes, safety glasses plus ear protection are essential. The correct grade of gloves (where appropriate) may also be required.

In many places, safety signs will designate where and what PPE is to be worn. Loose clothing and hair is an entanglement hazard, and steps must be taken to avoid this.

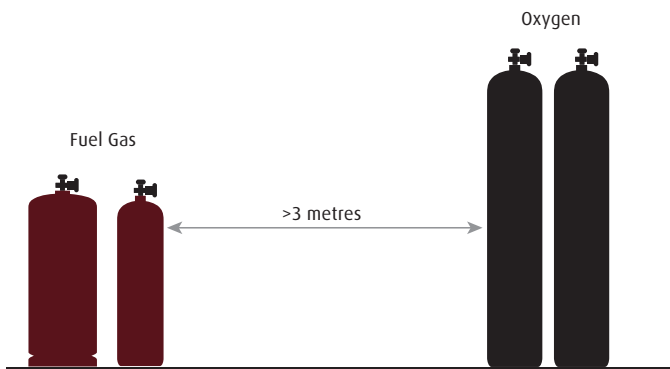

Fuel gases should be stored at least 3 metres from oxygen cylinders

Storage and segregation of cylinders

Within the storage area, oxidising gases such as oxygen must be stored at least 3 metres away from fuel gas cylinders (e.g. Acetylene, LPG, Hydrogen). The use of an appropriately fire rated wall may provide the required separation.

Full cylinders must be stored separately from the empty cylinders, and cylinders of different gases whether full or empty must be segregated from each other.

Where security is an issue, there is available a wide variety of Gas Cylinder Storage Systems which satisfy the cylinder storage requirements of AS 4332.

Contact BOC on 131 262 for details.

Storage of toxic gases

Toxic gases must be stored separately from all other gases and the detailed instructions on the individual BOC Safety Data Sheet (SDS) must be followed.

It is essential that when handling or storing cylinders containing toxic gases that the cylinder valve outlet threaded plug or cap is always replaced in the valve outlet when the cylinder is not in use or connected to a manifold or regulator. The cylinder valve outlet threaded plug or cap acts as a secondary valve to the valve itself and provides increased safety against leakage.

In an emergency involving a toxic gas or any other BOC gas, call 000, then inform BOC on the Emergency Response Line 1800 653 572.

For full details of local storage requirements consult the State Dangerous Goods regulations, and AS 4332.

Storage of fuel gases

Within the storage area, oxygen should be stored at least 3 metres from fuel gas cylinders. The use of a fire wall may provide the required separation. If volume is greater than 200 m³ a separation distance of 5 metres needs to be executed.

Note: wall must be a minimum of one metre higher than the tallest cylinder.

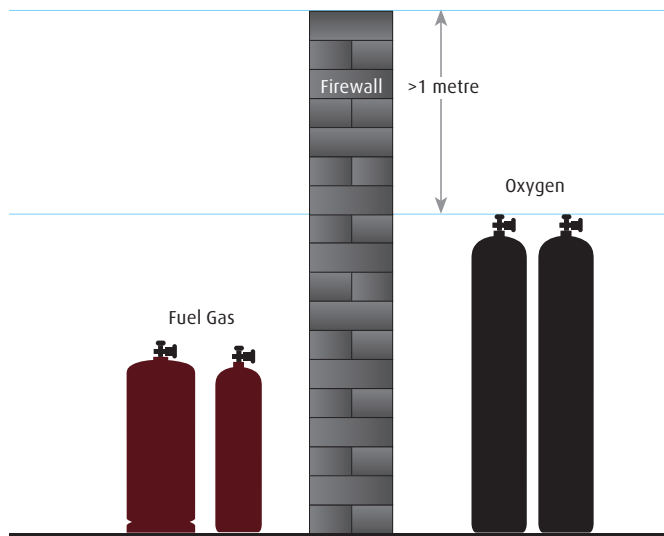

A fire wall must be higher than the tallest cylinder by at least 1 metre

Storing your cylinders safely

All cylinders should be considered and treated as full, regardless of their content. This means:

- Keep cylinders away from artificial heat sources (e.g. flames or heaters).
- DO NOT store cylinders near combustible materials, flammable liquids or incompatible materials.
- Keep flammable gases away from sources of ignition.
- Keep cylinders in well drained areas, out of water pools or ponds.
- The storage area should be kept well ventilated and clean at all times.
- DO NOT store in confined spaces.
- Avoid below-ground storage where possible. Where impractical, consider atmospheric monitoring or other risk control measures.
- There should be good access to the storage area for delivery vehicles. The ground surface should be reasonably level and firm (preferably concrete).
- The storage area should be designed to prevent unauthorised entry, to protect untrained people from hazards and to guard cylinders from theft.
- Different types of gases must be stored separately and in accordance with relevant Dangerous Goods legislation. Also refer to AS 4332 (The Storage and Handling of Gases in Cylinders)
- Stores must clearly show signage in accordance with state Dangerous Goods regulations. This includes Division Diamonds; HAZCHEM; no smoking and naked flame warning signs.
- Full and empty cylinders should be kept separate.
- Toxic and corrosive gases should be stored separately, away from all other gases.
- Liquefied flammable cylinders must be stored upright, to keep the safety devices in the vapour phase, on a firm, level floor (ideally concrete). This is also preferable for most other gas cylinders.
- Store cylinders away from heavy traffic and emergency exits.
- Rotate stock of full cylinders, and use cylinders on a 'first in, first out' basis.
- Avoid storing cylinders below 0°C. Some mixtures may separate below this temperature.
- DO NOT store cylinders at temperatures greater than 65°C (see Care of cylinders).

Care of cylinders.

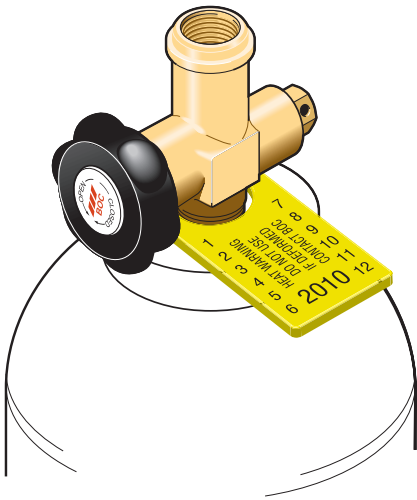

Top outlet valve showing a test date tag



Before

After

Heat indicator test date tags (view from tag underside – without markings)

Most accidents are avoidable

The majority of accidents involving compressed gas cylinders are avoidable with increased training and awareness of safety issues.

Handle cylinders carefully

Take care when handling cylinders to avoid impact damage. DO NOT drop cylinders off vehicles or docks when unloading or allow heavy objects to fall on them.

Impact damage can potentially reduce the cylinder wall thickness, which could lead to premature cylinder rupture.

Barcodes are to alert the fillers and operators when the cylinders are due for re-test, and for identification purposes. DO NOT under any circumstances tamper with or remove these.

Cylinders need to be kept cool

DO NOT store cylinders at temperatures greater than 65°C.

On extremely hot days every effort should be made to keep the cylinders in the shade.

Excessive heat – results in an increase in internal pressure.

Excessive heat can reduce the strength of the cylinder resulting in localised bulging at the source of the heat and in extreme cases cylinder rupture. Care must be taken with an oxy-fuel gas torch when in use. **DO NOT** allow the flame from an oxy-fuel gas torch or other appliance to point onto cylinders.

The plastic Test Date Tags (TDTs) fitted by BOC on the cylinder valve inlet connection will distort or melt at a predetermined temperature when heat-affected. This is to alert BOC (and customers) of any heat damage to the cylinder. Any heat-affected cylinders are sent to a BOC

cylinder test shop to determine if they are safe to be returned back into gas service or if they are to be scrapped.

Keep cylinders away from electric welding tools, red-hot metals, furnaces or any heat sources

Keep electrical welding equipment well away from cylinders. **DO NOT** allow welding torches to contact or get near cylinders.

An accidental arc between the tool and the cylinder could cause localised overheating of the cylinder wall and thereby weaken the cylinder.

Anything hot must be kept away from cylinders.

Take care not to allow welding and cutting sparks, flames or red hot slag to make contact with the exterior of cylinders, or their associated cutting equipment and/or hoses. Keep cylinders a safe distance from potential accidental spillages of molten metal.

If any of these hot items reach an acetylene cylinder, it will melt the fusible plugs and cause a release of acetylene gas and fire from the cylinder.

DO NOT put any cylinders adjacent to a furnace;

DO NOT put LPG cylinders near boilers or heaters.

Keep cylinders, valves and fittings clean

NEVER

- NEVER let oil or grease contact your cylinder or its valve and fittings.
- NEVER apply sealants (liquid or tape form) or lubricants to any cylinder valves or connecting fittings.
- NEVER use cylinders, whether full or empty, as any kind of support structure.
- NEVER roll them along the ground.

High pressure oxygen will react violently with oils and grease and cause a violent explosion or localised ignition leading to injury of the user and damage to equipment.

Oxygen equipment is at most risk from oil and grease so keep greasy hands, rags and gloves away from any part of the cylinder and fittings.

Wipe hands clean and try to minimise hand contact with surfaces which might be subject to oxygen under pressure.

Keeping cylinder valves clean

Cylinders are supplied with their cylinder valve outlets capped or plugged and in some cases PVC shrink wrapped.

The purpose of this is two fold:

- 1 To indicate the cylinder is full and
- 2 To keep the outlet clean and contamination free.

Top outlet valves, are particularly prone to dirt getting in the outlet.

If grit, dirt, oil or dirty water enters the cylinder valve outlet, this may cause damage to the valve internals and result in leakage.

Before assembling regulators and fittings make sure there are no particles of dirt in the cylinder valve outlet. If a supply of clean compressed oil free air or nitrogen is available, then, whilst wearing appropriate eye and ear protection, use this to blow out any loose particles of dirt from the valve outlet.

If a supply of clean compressed oil free air or nitrogen is unavailable, then use a clean lint free rag to clean the cylinder valve outlet, in particular the sealing surfaces.

NEVER open a cylinder valve to clear the outlet. For flammable gases this often leads to the ignition of the escaping gas. Ejected particles and resultant noise can also injure adjacent personnel.

NEVER attempt to repair a cylinder and/or its cylinder valve

If a cylinder is involved in an incident (especially cylinders involved in fires) it must be:

- Withdrawn from service
- Set aside and made clearly identifiable
- Identified to BOC (contact the BOC Emergency Response Line 1800 653 572)

Note: DO NOT immediately handle an Acetylene cylinder that has been involved in an incident.

NEVER disguise damage to cylinders

If a cylinder has been damaged (e.g. impact, involved in a fire), never paint over the damaged, discoloured or heat affected areas. Damaged cylinders must be notified to the gas company so that a detailed examination can be carried out to determine whether the cylinder(s) concerned can be repaired or need to be condemned.

Incidents have occurred where third parties have disguised damage to a cylinder which has resulted in a rupture of the cylinder when next refilled.

Cylinders must never be tampered with, repainted or relabelled by anyone other than the cylinder owner.

NEVER mix gases in a cylinder

NEVER mix gases in a cylinder; this must only be undertaken by authorised competent gas specialist personnel with suitable equipment and facilities under controlled conditions.

NEVER transfer gas to another cylinder

NEVER transfer, transfill or siphon gas from one cylinder to another. This can result in serious accidents.

NEVER scrap a cylinder you do not own

Most gas cylinders are owned by gas companies. There are however small numbers of privately owned cylinders e.g. individuals, companies or Government institutions. Ownership is indicated by the cylinder label. If the label is missing, ownership can be established by the permanent stampings on the cylinder shoulder.

Scrap metal merchants and recyclers must never buy gas cylinders as scrap metal unless the cylinders have been condemned by an authorised Test Shop.

If intact valved cylinders are discovered amongst recycled scrap, these must be set aside and the owner contacted (in most cases this will be one of the gas companies) with relevant particulars (i.e. colour, service, number and markings), to make arrangements for their collection and return.

NEVER use equipment with cylinders for which they are not intended

DO NOT attempt to make any adaptors or pipework to cross connect cylinders as this is potentially dangerous.

Working with gas cylinders. Use of gas cylinders and associated equipment.

Safe connection of equipment

Cylinder valve operation

Use care when opening cylinder valves. Cylinder valves should not be opened unless a pressure regulator has been fitted. Slowly open (anticlockwise) the cylinder valve using the hand wheel or (in a small number of cases) the cylinder valve key (obtainable from BOC Gas & Gear centres).

N.B. Soft seat, spindle key operated cylinder valves should not be subjected to excessive torque. Use the correct spindle key and only use moderate hand torque.

An opened valve should never be left against the backstop (i.e. fully opened until resistance is encountered), but should be turned back at least half a turn to avoid seizure in an open position. This can occur if the valve is left open for long periods of time.

When you shut the valve turn it clockwise just enough to stop the gas completely. NEVER over tighten.

Remember **all** cylinder valves are closed by turning the hand wheel in a clockwise direction. If you are going to stop work for a while (e.g. morning tea break, etc.) then close the cylinder valve.

Acetylene cylinders are to be used standing vertically on their base

Acetylene cylinders are designed to be transported, stored and used in an upright position.

Should Acetylene cylinders have been stored or transported horizontally, place the cylinders in a vertical position and allow 4 hours before use. This will allow the contents to settle and avoid release of solvent that can quickly vaporise potentially leading to an explosive atmosphere. It can also damage equipment. Equipment that has been affected by solvent should be immediately disconnected and placed in an open area where the liquid can evaporate safely.

For the few cylinders now still fitted with cylinder valve keys, only use the recommended cylinder valve keys.

- NEVER increase the leverage of keys by fitting handle extensions.
- NEVER use spanners with long handles.
- NEVER use badly worn cylinder valve keys.

Any of the above will damage the square end of the spindle or the valve's soft plastic (usually Nylon) seat.

If the valve spindle is too stiff to open by hand with the cylinder key, return the cylinder for exchange.

Sheared valve keys

N.B. Most cylinders are now supplied with hand wheels so this will be a rarity.

If you believe your cylinder valve has a broken or damaged spindle, (e.g. the cylinder valve key rotates without the valve opening), tag the cylinder valve as defective (include the date and a contact phone number on the tag), and call BOC on 131 262 for a replacement cylinder.

Only use equipment that is fit for purpose

The gas cylinder and outlet valve are designed to supply gas through pressure regulators that meet the requirements of the relevant Australian Standards.

Pressure regulators thread directly to the cylinder valve outlet (also applies to cylinder packs) so it is vital that the size and tolerance are to specification and meet the specified machining tolerance.

NEVER install additional piping or fittings between regulators and the outlet valves of cylinder packs.

When individual cylinders of the same gas are manifolded together to a common outlet, the pressure regulator must be connected to this single manifolded outlet.

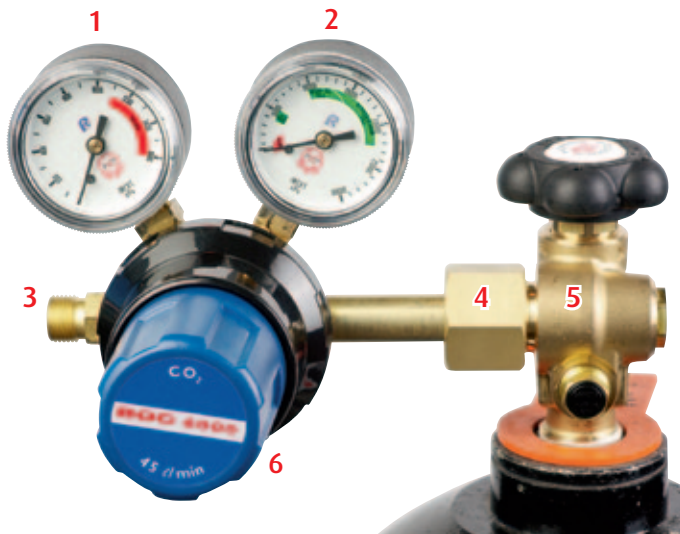

Typical single stage regulator

- 1 Outlet or Regulated Pressure Gauge
- 2 Inlet or Cylinder Pressure Gauge
- 3 Regulator Outlet Connection
- 4 Inlet Spigot (regulator)
- 5 Cylinder Valve
- 6 Regulator Control Knob Increase Pressure (Turn Clockwise)
Decrease Pressure (Turn Anti-clockwise)

Use the adjustment valves downstream of the pressure regulator only and not those fitted upstream, as this will starve the regulator of flow.

Pressure regulators: check the inlet spigot connection first

Make sure the pressure regulator is designed for use with high pressure gas cylinders and that the inlet spigot thread matches the cylinder valve outlet. Also check that the O-ring or seal is in place, clean and undamaged.

NEVER force any regulator connection that does not fit. Regulator connections can be fully threaded in by hand and then only require a fraction of a turn to achieve a gas tight seal. Regulators must be maintained in accordance with the manufacturer's instructions.

DO NOT attempt to repair or modify the regulator.

Before connecting a pressure regulator to a full cylinder always screw out (anticlockwise) the Regulator Control knob so that there can be no flow through the regulator when the cylinder valve is initially opened, this will lower the load on the internal safety device (known as a diaphragm) and increase the regulators life.

Only use gas for its intended purpose. Gas cylinders with their associated regulator and reticulation equipment are supplied for use in their intended application only. These uses are covered in gas supplier catalogues.

DO NOT experiment with gas or gases. If in doubt and/or expert assistance is required, then please consult BOC Technical Service desk on 131 262.

DO NOT use oil or packing on any regulator – oxygen or not

NEVER try to ease any regulator threads with oil

DO NOT use PTFE tape. This advice applies to all gas cylinders and regulators.

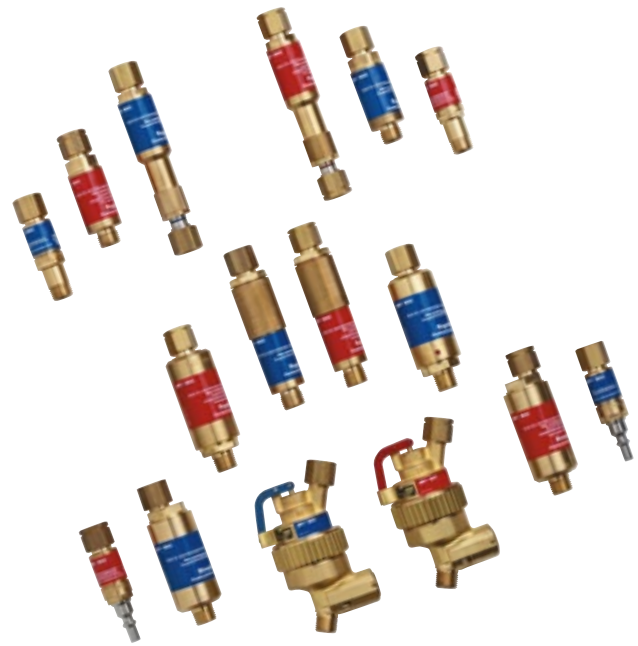

Selection from the range of BOC Flashback Arrestors

NEVER pack out or use any connection that appears worn when tightening or loose when fully screwed home.

Fuel gas (Hydrogen, Handigas® (LPG), Acetylene): use only the regulator designed for the gas

DO NOT interchange left-hand threaded pressure regulators between gases. Each is designed for use with a specific gas, and to interchange them could be hazardous. Remember the cylinder pressure and properties are different for each gas.

DO NOT use left-hand to right-hand adaptors.

Fit flashback arrestors

To prevent flames travelling back into cylinders, flashback arrestors should be fitted onto the outlets of pressure regulators in Oxygen / Acetylene, Handigas® (LPG) and Hydrogen systems as well as the equipment end such as blowpipes where flammable mixtures can occur.

Does your manifold have the right regulators and flashback arrestors?

Where cylinders are connected to a manifold, the system must be properly designed for the task and installed by a competent trained technician. It must be fitted with one or more pressure regulators. Acetylene, Handigas® LPG (industrial applications) and hydrogen manifolds must also be fitted with flashback arrestors at both regulator and equipment ends.

Choosing safe equipment.

Pressure regulator: be guided by the gas supplier

Where a pressure regulator is fitted with gauges (content and delivery pressure), these should never be removed, exchanged or tampered with in any way. Replacement gauges are available from your local BOC branch and should only be fitted using oxygen safe tape.

Hoses: use the right colour and the right quality

Colour coding for hoses

Gas	Colour
Oxygen	Blue
Acetylene	Red
LPG	Orange



Only use hose that conforms to the relevant Australian Standard (AS 1335 for oxygen, acetylene and LPG hose used for welding, and AS 1896C for LPG hose for industrial applications). Hoses should be colour coded in accordance to the same standards.

Hoses: use the right end connection

Incorrect hose connections are a frequent cause of accidents.

Hose connections must conform to the pressure and mechanical properties requirements described in AS 1335 and AS/NZS 1869 for LPG.

BOC twin hose complies with these requirements and is supplied with the correct threaded connections (left handed for fuel and right handed for oxygen) to fit either the pressure regulators or flashback arrestors.

Purge hoses and check for leaks and visible signs of damage before lighting a cutting or welding torch. Check connections regularly.

Flashback arrestors

A flashback is a flame, travelling at supersonic speed, in the opposite direction to normal gasflow in oxy-fuel gas equipment. The use of flashback arrestors is required to limit the potential damage that may result if a flashback occurs. If not stopped, a flashback can melt the equipment which, in the worst case, could explode and travel back to the cylinder.

BOC resettable flashback arrestors have a sensitive non-return valve that stops the gas flow and can be reset once inspection of equipment for the cause has taken place. All BOC flashback arrestors have a fine sintered filter that quenches the flame. On BOC regulator end flashback arrestors, a thermal cut-off valve is built in, which will activate if there are multiple flashbacks or a build up of heat stopping the flow of gas before ignition upstream occurs.

To ensure total safety and protection from the causes and effects of flashbacks, BOC flashback arrestors should be fitted to each gas line, as the risk of a reverse flow of gas exists with both oxygen and fuel gas. According to AS 4839 flashback arrestors should be tested every year.

DO NOT use longer hoses than necessary

For fixed installations according to AS 4289.

For safety purposes, hoses shall be installed as follows:

- a Protected from heat, mechanical damage, traffic, sparks, slag, and oil or grease. They shall be as short as possible. Where longer lengths are needed, extension hoses, coupled by means of hose connectors suitable for use with Oxygen and Acetylene, may be used, but should be avoided wherever possible.
- b Copper pipe shall not be used to couple hoses carrying acetylene.

For portable equipment according to AS 4839:

- a The maximum hose length shall be fifteen (15) metres for each gas, or such a distance which will allow the operator of hand-held equipment to be in sight of all supply cylinders, whichever is the smaller. Hoses shall be single length.

DO NOT use hoses that appear worn

Hoses showing signs of deterioration must be scrapped.

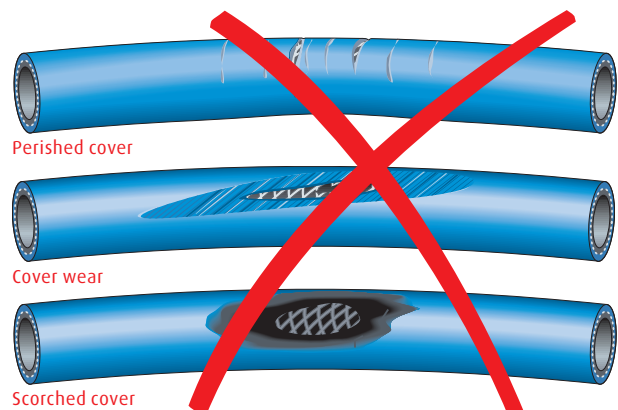

DO NOT use hoses that appear worn

Use correct Personal Protective Equipment (PPE)

When welding or cutting use goggles with double lenses to protect your eyes against glare and mechanical impact from flying fragments. The inner lens should be tinted and the outer lens clear. The clear outer lenses should be changed regularly when spatter builds up.

It is also advisable to wear eye protection (spectacles or goggles) when handling high pressure gases to protect the eyes against flying dust particles in the gas stream.

DO NOT wear clothes made of highly combustible materials. Leather gloves or gauntlets should be used when necessary. In awkward work locations additional protective clothing may be required.

Avoiding contamination of the cylinder.



NRV/MPR valve (side outlet)

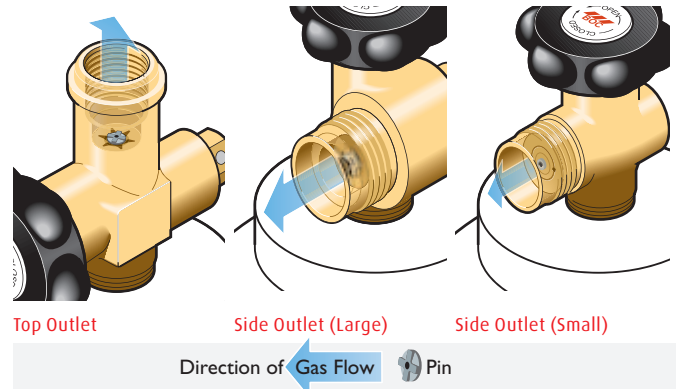

Examining the cylinder valve outlet

Recognise the hazards of backflow

Cylinder contamination can compromise the:

- Quality of the gas,
- Safety of the cylinder; and as a result,
- Safety of the end user.

Minimum Pressure Retention/Non-Return Valves

Minimum Pressure Retention (MPR) valves were developed to reduce the risk of contaminants, such as air and moisture, flowing back into the cylinder which can occur when the valve is left open or the valve is connected to the incorrect equipment. More recent cylinder valves have been fitted with residual pressure device cassettes with a non-return valve (NRV) function designed to counter the risk of backflow, which can occur when manifolded cylinders together. This is commonly referred to as a NRV/MPR valve (pictured above) to distinguish it from its MPR predecessor.

These valves are in both top outlet and side outlet configurations. They can be identified quite easily by examining the cylinder valve outlet. If you look inside the valve outlet, a 'pin' can be seen either in the bore or protruding slightly from the bore of the cylinder valve outlet.

Note: NEVER damage or interfere with the operation of this pin.

If the cylinder valve fitted is not an NRV/MPR cylinder valve then safety hazards can be created if gaseous or liquid contaminants are allowed to pass back into the cylinder. Precautions must be taken to ensure that when the cylinder is in use no backflow of gas or liquid can occur.

Take precautions to prevent backflow into the cylinder

It is particularly important to ensure that when cylinders are connected to a process in which the process pressure can exceed the cylinder

supply pressure that adequate precautions are taken to avoid backflow into the cylinder. The following should be observed:

- **ALWAYS** close the supply cylinder valve when not in use.
- **NEVER** leave an empty cylinder connected to a process.
- **NEVER** use a cylinder as a receiver for waste gas, liquid or other material.

Practical ways of preventing backflow

If the cylinder is not fitted with a NRV/MPR cylinder valve, then

Fit a suitable, good quality 'non-return valve' (also called 'check valve')

This is the simplest and most cost effective method of preventing backflow but it must be considered as the minimum requirement. These valves require regular maintenance as particulate matter or corrosive conditions can prevent efficient resealing.

Fit an automatic shut-off /isolation valve

This should be activated by a low pressure signal when the supply gas cylinder pressure reaches a level that requires the cylinder to be replaced. An alarm should normally be incorporated into the system to alert the operator.

Notify BOC if cylinder contamination occurs

If you know that a cylinder has become contaminated – by whatever means or whatever the contamination – inform BOC and label the cylinder before it is returned giving any relevant information about known or suspected contamination.

This information is required even if the contaminant, such as water, has been emptied out of the cylinder before return.

Keeping your equipment safe. Equipment leak detection.

Regularly check for faults and leaks

Leaks may develop in any part of a gas system, but particularly at joints. It is important that all equipment is regularly checked and corrective action taken before use.

As a matter of routine, always check for leaks when cylinders are stored and when they are assembled with equipment for use.

When assembled, special attention should be paid to all joints and blowpipe valves. Use a BOC approved LDF (Leak Detection Fluid) or an ammonia free, soapy water solution applied with a brush.

Warning – beware of the dangers of using leak detecting fluids which are incompatible with oxygen as LDF residues could cause spontaneous ignition. Only BOC approved LDFs should be used.

Wipe the area dry with a clean lint-free cloth after you have completed the check. If there is any bubbling or foaming of the leak detection fluid during testing this indicates leakage. The equipment should be immediately depressurised and the leak corrected.

- Regularly check for leaks and faults, only with approved leak detection fluid.
- Keep ammonia-based leak detection solutions, oil and grease away from cylinders and valves.
- NEVER use a flame when testing for leaks
- NEVER tighten equipment while the equipment is under pressure

TIPS on equipment safety

- Pay special attention to pressure regulators. If a regulator is defective or if a pressure gauge is broken, have it replaced immediately.
- Leakage around the valve key of the cylinder valve will be revealed by either hissing or, in the case of fuel gases, by an odour.
- Have any hose that shows signs of deterioration replaced.
- Examine the blowpipe nozzle regularly and if it is becoming clogged, clean it in the manner described by the manufacturer.
- Keep equipment clean. In particular oxygen regulators must be kept in a clean area when not in use.
- NEVER cut or weld above or near cylinders or equipment if there is a likelihood that sparks or molten material will come into contact with them.

If in doubt contact BOC on 131 262 for advice. If safe to do so, move the cylinder to a remote, well ventilated area.

DO NOT use coiled hoses

Ensure that both hoses are of equal length. DO NOT coil surplus hose around the cylinder, regulator or on the floor adjacent to cylinder when in storage or when in use.

A fire in a coiled hose is very difficult to extinguish.

If you do have surplus hose, position it behind you to keep it clear of sparks.

If something goes wrong.

In all emergencies, phone Emergency Services on 000, and always use protective clothing and equipment

Gas cylinders in fires

Actions to be taken when fire is discovered

Gas cylinders involved in a fire may explode.

If cylinders are in a fire the key actions to be taken are:

- Evacuate the area (min. 100 m radius).
- Call the fire brigade on 000.
- Advise persons between 100–300 m from the cylinder to take cover.
- When the fire brigade arrives inform them of the location and number of gas cylinders directly involved in the fire, and the names of the gases they contain.
- Cylinders which are not directly involved in the fire and which have not become heated should be moved as quickly as possible to a safe place – provided this can be done without undue risk. Make sure these cylinder valves are closed.
- As soon as possible, inform BOC on the Emergency Response Line 1800 653 572.
- DO NOT use cylinders that have been exposed to a fire until BOC has examined them.

Remember that even after the fire has been extinguished some cylinders which have been heated can explode, particularly acetylene cylinders.

Cylinders exposed to a heat source

Cylinders which have been exposed to excessive heat – such as fire or by accidental impingement of a flame – may fail when next filled and may result in a gas filler's death.

ALWAYS clearly mark fire exposed cylinders and advise BOC. A damaged heat tag is a sign of a fire exposed cylinder.

Under no circumstances should you clean or repair the cylinder!

DO NOT use any fire damaged cylinders.

Leaking cylinders

Gas from a leaking flammable cylinder may ignite in the presence of an ignition source.

DO NOT enter an atmosphere which may contain a flammable gas/vapour and air mixture in the flammable range without either:

- a Testing that the flammable gas/vapour content is less than 20% of the Lower Explosion Limit (LEL) or
- b Ventilating prior to entry to achieve (a).

(DO NOT use electrical fans etc. to ventilate unless flameproof.)

Leaking acetylene cylinders

1 Where an ignition has not occurred.

Try to stop the leak by closing the cylinder valve. If the leak cannot be stopped and:

- a There is no ignition of the escaping gas, and
- b The cylinder is not becoming hot

then take the following actions to prevent ignition and resulting harm to people and/or property:

- Avoid any source of ignition.
- Evacuate uninvolved personnel from the area.
- If safe to do so, remove cylinder outside to a well ventilated area, carefully avoiding shocks, bumps, and ignition sources and staying out of the path of escaping gas in case it ignites.
- Inform BOC Emergency Response Line 1800 653 572.
- Ensure the work area is thoroughly ventilated before re-entry.

Hot acetylene cylinders must be dealt with as set out in the paragraph 'Gas Cylinders In Fires'.

If the leak has ignited then follow the recommendations below:

2 Where an ignition has occurred

Only when it can be done immediately after ignition, close the cylinder valve to stop the gas flow. Feel the cylinder shell with bare hands for any rise in temperature.

If

- The cylinder becomes hot.
- The flame or gas flow does not stop.
- There is any doubt or other reason.

Then

- Call the Fire Brigade on 000.
- Evacuate the area 200m (radius) direct line of view of the cylinders.
- If safe eliminate all other sources of ignition.
- Inform BOC Emergency Response Line 1800 653 572.

A flame from an acetylene cylinder which is in a room and whose valve cannot be closed should normally be left to burn while cooling the cylinder with water. If the flame is extinguished, the acetylene continues to escape and can re-ignite and result in a fire or explosion. The flame should only be extinguished if:

- leaving it burning will cause a more dangerous situation.
- The acetylene flow is very small and the cylinder can be safely and quickly carried out to a safe place in the open air.

Ensure working area is well ventilated before re-use. In all other circumstances, keep the cylinder cool until the fire brigade arrives.

Even once the fire has been extinguished, dissolved acetylene cylinders need to be cooled for a total of 24 hours.

BOC will arrange for collection of the cylinder after the 24 hour cooling period.

Leaking LPG Cylinders

1 Where an ignition has not occurred

If a leak has occurred but not ignited, which cannot be stopped by closing the valve, do not attempt to tighten the cylinder valve in the body or tamper with safety devices, but take the following actions immediately:

- Call the fire brigade on 000.
- Eliminate all sources of ignition.
- Evacuate the area.
- Remove the cylinder to a safe position outside, at least 100m direct line view of the cylinders. If possible keep the leak facing up. Keep away from drains.
- Warn everyone in the area of the gas leak giving priority to those downwind and downhill.

2 Where an ignition has occurred

- Call the fire brigade on 000.
- If the valve is accessible and it is safe to do so, attempt to close the valve.
- If the flame from the cylinder has started a secondary fire which is heating the cylinder, evacuate the area 100m around the cylinder.
- If possible cool the cylinder with a water spray from a protected position.

Leaking hydrogen cylinders

TAKE CARE! Hydrogen burns with an almost invisible flame. Burning hydrogen can be detected by the feel of heat, looking for signs of heat shimmer in the air and falling droplets of water.

1 Where an ignition has not occurred

If a leak has occurred but not ignited, which cannot be stopped by closing the valve, do not attempt to tighten the cylinder valve in the body, but take the following actions:

- Call the fire brigade on 000.
- Eliminate all sources of ignition.
- Remove to a safe position outside.
- Ensure the work area is thoroughly ventilated before re-use, particularly at high level.

2 If an ignition has occurred

- Call the fire brigade on 000.
- If the valve is accessible and it is safe to do so attempt to close the valve (take care as a hydrogen flame is almost invisible).
- If the flame from the cylinder has started a secondary fire take key actions as set out in 'Gas Cylinders in Fires'.

Leaking toxic gases – ammonia

The odour of ammonia is very characteristic and quite recognisable, providing adequate warning of its presence.

Ammonia is severely irritating to the skin and to the mucous membranes of the eyes, nose, throat and lungs. Ammonia is flammable in air only at comparatively high concentrations (15-28% by volume in air). These limits are seldom encountered in practical handling.

DO NOT enter an atmosphere which may contain toxic gas without either:

- Testing that no toxic gases are present, or
- Wearing Self Contained Breathing Apparatus (SCBA).

The precautions to be taken with toxic gases are:

- Leak-check systems by pressurising with inert gas before admitting toxic gas, and using leak detection solution on joints.
- Provide good local ventilation or mechanical extraction.
- Use a gas-specific leak detection method.
- Install atmospheric monitoring and alarm (this may be mandatory by legislation).
- Assure breathing quality air for:
 - Normal operations
 - Emergencies
- Have on hand:
 - SDS
 - Emergency equipment
 - Specific operating and emergency procedures

Leaking asphyxiant gases

Gases which create a hazard by displacing oxygen are called simple asphyxiants.

Poisonous gases are hazardous at parts per million in the atmosphere. Flammable gases enter the flammable range at a few percent in the atmosphere. However, any gas whether poisonous, flammable, non-flammable, toxic or non-toxic can create an additional hazard if its concentration lowers the oxygen concentration to 19% or less.

Risk of altered gas concentrations

Because gases are stored under pressure, gases leaking out of the storage container into the working atmosphere may displace other gases in the atmosphere, upsetting the normal balance.

DO NOT enter an atmosphere which may be deficient in oxygen without either:

- a Testing the oxygen content is normal (19–23%), or
- b Wearing Self Contained Breathing Apparatus (SCBA)

Asphyxiation can cause death in seconds if the oxygen content is 0%, or minutes if it is less than 19%.

Generally there are no warning signs that an atmosphere contains increased concentrations of other gases and a deficiency of oxygen.

Any enclosed area in which gases are being stored, piped, used or vented may become deficient in oxygen.

In addition, because many gases are heavier than air, and collect in pits and drains, even small hatchways and coverings may contain oxygen deficient atmospheres.

DO NOT enter these areas without appropriate Self-Contained Breathing Apparatus & Life Line.

Leaking oxidising gases

Because oxygen is very reactive, almost everything will react with it given the right conditions of heat and pressure.

Oxygen at high pressures in cylinders and pipework poses an extra hazard.

DO NOT enter an atmosphere which may be enriched with oxygen without:

- a Testing the oxygen content is normal (19–23%),
- b Dampening clothing, and
- c Avoiding sources of heat and ignition.

Poor system design can lead to hazards when using oxygen.

Contaminants in oxygen systems

Oxygen systems made up of 'oxygen compatible' components can also be contaminated with non-compatible materials. Oil, dust, and grit are examples of contaminants that burn readily or provide a source of ignition in such systems.

Sources of contamination

Contamination in an oxygen system can come from two sources:

- From poor cleaning of the system at the time of assembly
- From contamination introduced during its service life, either by wear of components or through incorrect maintenance procedures.

Contamination can be ignited

Contamination that is not removed from the system can be easily ignited and can promote fires of other materials. If the fire is extensive it may rupture the system.

Flashback to an acetylene cylinder

Fitment of flashback arrestors at both the regulator and equipment end will greatly lower the likelihood of a flashback travelling back to the cylinder. A flashback is the return of flame through the blowpipe or even the regulators. It may also reach the Acetylene cylinder causing heating and explosive decomposition of the contents; it can be caused by faults in the equipment and/or poor procedure. In most cases a flashback does not travel beyond the cylinder neck.

You may be able to identify a flashback has occurred by:

- An audible 'pop' or muffled gunshot sound.
- Hot spot on the cylinder.

If a flashback occurs take the following actions, if safe to do so:

- Close both blowpipe valves – oxygen first.
- Close both cylinder valves.
- Check the acetylene cylinder shell with the bare hand for a rise in temperature (if hot or glowing, evacuate area immediately and take actions as per 'Gas Cylinders in Fires')

If the temperature of the acetylene cylinder shell rises, treat the cylinder as if it had been involved in a fire – see 'Gas Cylinders in Fires'.

- If the temperature of the acetylene cylinder shell does not rise, unwind pressure adjustment screw on each pressure regulator.
- Check that the nozzle is not damaged and that it is tight.
- If the blowpipe is overheated, plunge it into cold water.
- Carry out the start procedure as recommended by the equipment supplier.
- If the flashback recurs immediately, the blowpipe/nozzle may be faulty and should not be used again. Again check if cylinder is heating (refer 'Gas Cylinders in Fires' and contact BOC).

Frozen regulators or valves

Thaw with warm water, never by flame. This condition may be caused by excessive flow rates. Contact BOC.

Frosted cylinders

This condition is usually due to excessive draw-off rate and can be overcome by seeking expert advice on manifolding cylinders – DO NOT attempt to heat the cylinders.

Keeping your environment safe.

Be aware of all possible hazards

The environment can be contaminated or adversely affected by one or more of the following hazards:

- Oxygen enrichment,
- Oxygen deficiency,
- Accumulation of fuel gases,
- Welding and other fumes,
- Noise,
- Fire.

Know the danger, composition and behaviour of air

The approximate volumetric composition of the main components of air is as follows:

Oxygen	O ₂	21%
Nitrogen	N ₂	78%
Argon	Ar	1%

The atmospheric gases are non toxic, but alterations in their concentrations – especially that of oxygen – have an effect upon life and combustion processes. It is essential to have sufficient oxygen in atmospheres being breathed.

Although not flammable itself oxygen vigorously supports combustion whereas nitrogen and argon inhibit combustion.

If good practice is not observed accidents may occur because changes in gas concentration can be very rapid and cannot be detected in good time by odour or sight.

Fire hazards from oxygen enrichment

Oxygen reacts with most elements. The initiation, speed, vigour and extent of these reactions depend in particular upon:

- The concentration, temperature and pressure of the reactants.
- Ignition energy and mode of ignition.

Combustibility of materials

Oxygen enrichment of the atmosphere, even by a few percent, considerably increases the intensity of fire. Sparks which would normally be regarded as harmless can cause fire and materials which do not normally burn in air, including fireproofing materials, burn vigorously in oxygen-enriched air.

Smoking is not allowed where oxygen is stored or being used

Many burning accidents which occur are triggered off by the lighting of a cigarette, therefore it is impossible to over-emphasise the danger of smoking in oxygen-enriched atmospheres or where oxygen enrichment can occur. Locations where Oxygen is stored or being used are to be designated **NO SMOKING** areas.

IMPORTANT NOTE: Should cylinder show any signs of being affected by flood water or bush fire damage, contact BOC for advice on 131 262.

Prevent oxygen enrichment of the environment

Oxygen enrichment of the atmosphere is best guarded against by careful attention to the following points.

Leakage of equipment

Newly assembled equipment for oxygen service should be thoroughly leak checked using an ammonia free soapy water solution or an approved leak detection fluid available from BOC. Periodic retests are recommended. Pressure drop tests are a good way to identify leaks.

All equipment, for instance welding and cutting nozzles and hose connections, should be properly fitted. Hoses and other equipment should be kept leak tight and be protected from damage. All maintenance and repair work should be carried out by experienced and fully skilled personnel.

When gas is no longer required or the shift is over, the cylinder valve or oxygen supply stop valve must be turned off, in order to avoid possible oxygen leakage in the time between the end of one working period and the beginning of the next. The gas valves on blowpipes or cutting torches should not be used to perform this task.

Incorrect practice in the use of blowpipes

Care should be taken, especially in confined spaces, to avoid delay in lighting the blowpipe after opening the valves.

When flame cutting, besides the oxygen for the preheating flame, a considerable amount of oxygen is also required for burning the material and blowing out the slag. This leads to an excess of unused oxygen, the amount of which will increase if the pressure employed is too high, or if the nozzle is too big for the workpiece being cut. It is therefore important to select the correct nozzles and pressures.

Improper use of oxygen

In addition to the previously mentioned hazards of oxygen enrichment of the air, it is vital to note that **UNDER NO CIRCUMSTANCES** is oxygen to be used as a replacement for instrument air. Oxygen is an oxidising gas and strongly supports combustion and is **UNSUITABLE** for the following purposes:

- Driving pneumatic tools.
- Inflating vehicle tyres, rubber boats etc.
- Cooling or freshening the air in confined spaces.
- Cooling the person as air conditioning.
- Dusting benches, machinery and clothing.
- Starting diesel engines.

It should be appreciated that this list is by no means complete.

Wear the correct clothing

Many so-called non-flammable textile materials will burn fiercely in air containing as little as 30% oxygen, and no material should be considered safe unless it is known to have been subjected to a proper test.

Clothes should be well fitting, yet easy to remove and free from oil and grease.

Persons who have been exposed to an oxygen-enriched atmosphere must not smoke or go near hot spots or sparks until they have properly ventilated their clothes in a normal atmosphere. A ventilation period of a minimum of 5 minutes with movement of the arms and legs and with the coats unbuttoned may be necessary.

When working with flammable gases (acetylene, hydrogen, LPG), only cotton clothing should be worn. Man-made fibres should not be worn as they generate static electricity sparks which can ignite flammable gases.

Prevent oxygen deficiency in the environment

Oxygen deficiency of the atmosphere is best guarded against by careful attention to the following points.

Leakage of gases other than oxygen

This leads automatically to oxygen deficiency.

Consideration should be given to the use of atmospheric monitoring in confined spaces.

Vent outlets

Vented gases are often deficient in oxygen, and work should not be carried out in such atmospheres.

Welding and heating processes

All gas welding and heating processes involve taking oxygen from the air and can tend to cause an oxygen deficiency unless the volume of workspaces and their ventilation is sufficient.

Use of gases other than air in closed areas

An appropriate risk assessment and/or Permit to Work procedure may be needed.

Physiological hazards due to oxygen deficiency

Oxygen is essential to life, and it is therefore vital to ensure that adequate oxygen is present in any atmosphere being breathed.

Respiratory complications may occur in an atmosphere containing less than 19.5% oxygen.

A significant feature of oxygen deficiency is that it cannot readily be detected by the senses, and victims are usually unaware of the danger they are in and may even have a feeling of wellbeing.

Prevent dangerous accumulations of fuel gases

In certain procedures, fuel gases are used along with oxygen. Fuel gases that escape may form ignitable and explosive mixtures with the surrounding air and lead to fires or explosions. The ignition limits of the most common fuel gases when mixed with air are:

Fuel Gases	Upper and Lower Explosive Limits
Acetylene	2.5–85.0 vol %
LPG (e.g. Handigas®)	2.2–9.5 vol %
Hydrogen	4.0–75.0 vol %

The lower limit is particularly important, as this is the one that is reached first. There is less danger that these ignition limits will be reached in large welding shops that have good natural ventilation or are in the open air. However, inside containers or in confined spaces, even small quantities of escaping fuel gas are sufficient under certain conditions to form an ignitable mixture.

Acetylene and LPG can be recognised by their distinctive smell even in very small concentrations.

Acetylene/LPG in the air is therefore very easily detected by a good sense of smell, enabling corrective action to be quickly taken.

LPG (e.g. Handigas®) will accumulate in low-lying areas

Because of its high specific gravity, Handigas® flows to the ground like a liquid when there is little air movement; thus it may remain for a very long time if there is no way for it to flow away. It is then possible for ignitable concentrations to arise.

Check hoses and apparatus for leaks

Undesirable mixtures of fuel gas and air are usually the result of leakages, due for example to faulty hoses, missing hose clips on hose connectors or torches, or faulty torches and torch hoses.

Close valves when apparatus is not in use

In many instances, accidents could have been avoided by closing valves. In some cases, leaky equipment or torches with the fuel gas valve not properly closed have been left in workshops for long intervals resulting in serious accidents when work was resumed.

Remove gas equipment from confined spaces when not in use. Beware of fumes being generated

Gas equipment connected to a supply must not be allowed to remain in confined spaces or vessels during rest intervals or meal breaks, but must be taken out for that time.

Cutting and welding metals by flame or arc processes produces fume. The fume is in two parts.

- 1 Particulate fume, which is usually visible as smoke, and consists of fine metal oxide powder. The composition of this fume depends upon the metal being cut or welded and in the case of welding, the composition of the filler rod or wire.
- 2 Gaseous fume, which is not visible and is usually composed of combinations of oxides of carbon or oxides of nitrogen and ozone.

Ensure that fumes are removed quickly from the work area

The solution to fumes is good local and general ventilation. Local ventilation should be arranged to suck the fume away as it is formed. A number of companies market such units. General ventilation should ensure that the whole atmosphere of the work shop is changed a number of times during a shift.

Check the properties of filler rods and wires

Some filler rods/wires in welding or brazing may contain particular toxic materials, and the suppliers of these rods or wires should be contacted regarding the hazards and any special fume removal requirement as listed in their respective SDS's.

Take special precautions when welding or cutting coated metals

Finally it is most important to take special ventilation precautions when welding or cutting metals that are coated, (e.g. painted, galvanised etc.,) because their coatings can produce copious quantities of toxic fumes.

Noise

Some processes can result in high noise levels. This should be taken into consideration when planning the work and the necessary precautions taken to ensure compliance with current noise legislation.

Fire

NEVER underestimate the fire hazard in flame and arc processes particularly as sparks can travel quite an appreciable distance.

- 1 Where possible work well away from combustible materials such as wood.
- 2 Remove all materials likely to catch fire.
- 3 Make sure the floor is swept clear of combustible debris or dust.

- 4 Work well away from products which give off flammable vapours i.e. paints, thinners, fuels etc.
- 5 Avoid work on wooden floors or close to wooden roof joists, unless protected by sheet steel or other flame/heat resistant material. Sparks falling through gaps in floorboards are a particular source of danger.
- 6 Keep fire extinguishers, sand and water available. If necessary douse floor and walls with water before starting work.
- 7 If you suspect that sparks may have come in contact with wooden structures or entered wall cavities, special visual inspection should be taken after the work has finished. Remember that fire can smoulder for long periods before spontaneous ignition.
- 8 Always check the work area before leaving, for sparks, smouldering materials etc.



DO NOT weld or cut a tank or vessel until it has been treated to make it safe

Working on the welding or cutting of tanks or vessels which may have contained explosive or flammable materials

DO NOT weld or cut tanks or vessels which may have contained petrol, oils, spirits, paint or any flammable or explosive material without making sure that the vessel contains no trace of the substance or explosive vapours, and has been treated to make it safe for welding and/or cutting.

Before beginning to weld or cut a tank:

- 1 Remove residue by thorough boiling or steaming immediately before starting.
- 2 Fill the vessel with water to within 2-5 cm of the points where the flame is to be applied.
- 3 If possible vent the enclosed air space.
- 4 NEVER blow out the vessel with oxygen.
- 5 NEVER approach with naked lights until thorough ventilation has been carried out.
- 6 DO NOT use empty oil, petrol or other flammable liquid drums or containers as support for work.
- 7 Post a warning notice as required.

BOC offers a nitrogen purging service for such tanks or vessels. Contact your local BOC branch or Customer Service on 131 262 for further details.

Glossary.

AS — Australian Standard

Asphyxiate — To cause reduction of or displacement of oxygen from red blood cells.

Backflow — Also known as 'reverse' flow, where contaminants such as air or moisture enter the cylinder.

Backstop — Mechanical stop encountered when fully opening a cylinder valve.

bar — a unit of measure of pressure, equal to one million dynes per square centimetre. 106 dyne/cm², 105N/m², 0.98692 atm. Refer to the pressure cross reference chart on page 39 for more information.

Burst disc — A type of pressure relief device which consists of a disc, usually of metal, which is held so that it confines the pressure of the cylinder under normal conditions. The disc ruptures at a design pressure/temperature range selected for overpressure or in the case of cylinders in fires, to prevent the rupture of the container.

Cylinder Valve key — A tool used to open or close cylinders. Applies to cylinders which do not have a handwheel fitted to the cylinder valve, these cylinders are opened and closed by inserting and turning a cylinder valve key.

Flashback — The return of flame through the blowpipe into the hoses and even the regulators. It may also reach the acetylene cylinder causing heating and explosive decomposition of the contents.

Flashback arrestor — The arrestor quenches a flame front (flashback or acetylene decomposition) travelling in a direction opposite to the normal flow. Flashback arrestors often incorporate other safety features which may include non return valves, cut off valve and safety valve.

Gauge (g) — Suffix to indicate the pressure relative to the local atmospheric pressure, not as an 'absolute pressure'. Indicated as directly following the usual unit measurement e.g. barg, psig, kPag.

Gland nut — An adjustable nut which when tightened compresses a gland seal to form a leak tight joint between the mating metal surfaces (i.e. in the case of a cylinder valve, the body and stem).

Liquefied gas — A gas which, when packaged under pressure for transport, is partially liquid at a temperature above -50°C

LDF — Leak detection fluid, applied to valve and other potential leakage points, to detect leaks e.g. VFV Leak Detector, Teepol HB7.

NRV/MPR — Non Return Valve / Minimum Pressure Retention and is sometimes used in the reverse order. This is a function incorporated in certain cylinder valves in that they retain a minimum pressure in the cylinder, typically of a nominal 5 Barg. They also incorporate a non return gas flow function to prevent higher pressure gas from entering the cylinder if hooked up to the cylinder valve outlet. In Europe, these are simply referred to as RPV valves.

Non return valve — A valve which is designed to only allow flow in one direction. The direction is indicated by an arrow on the valve body.

Pack (also known as Bundle / Manifolded Cylinder Pack / MCP) — A number of cylinders (usually 4-15) manifolded and palletised together to common outlet(s) (usually 2) and contained within a standard pallet footprint.

Permanent gas — A gas that has a critical temperature below -10°C. (In everyday terms a gas that cannot be liquefied by increasing pressure at ambient temperatures e.g. oxygen, nitrogen, argon).

POC — Privately Owned Cylinder

PPE — Personal Protective Equipment relates to clothing, footwear, hand, face and hearing protection appropriate when handling and using gases.

Pressure drop test — A leak check where the equipment is pressurised to normal working pressure and no pressure drop is observed over 5 minutes. If a pressure drop is observed, this indicates a leak in the assembly.

Pressure gauge — A device which indicates pressure.

Pressure regulator — A device used to reduce pressure from a higher pressure source such as a gas cylinder to a controllable safer working pressure range.

SDS (Safety Data Sheet) — Information sheet detailing the following specifics relating to a particular gas:

- Identification of the material and supplier
- Hazards identification
- Composition / information on ingredients
- First aid measures
- Fire fighting measures
- Accidental release measures
- Storage and handling
- Exposure controls / personal protection
- Physical and chemical properties
- Stability and reactivity
- Toxicological information
- Ecological information
- Disposal considerations
- Transport information
- Regulators and other information

TDI — Test Date Tags are tags fitted to cylinders designed to distort or melt when heat affected to alert BOC of any heat damage to the cylinder.

Pressure cross reference chart

kPa	bar	Millibar(mbar)	atm	kg/cm ²	psi	mm.Hg	Metres H ₂ O at 20°C
1	0.010	10.000	0.010	0.010	0.145	7.501	0.102
100.000	1	1000.000	0.987	1.020	14.504	750.063	10.216
0.100	0.001	1	0.001	0.001	0.015	0.750	0.010
101.325	1.013	1013.250	1	1.033	14.696	760.001	10.351
98.067	0.981	980.665	0.968	1	14.223	735.560	10.018
6.895	0.069	68.948	0.068	0.070	1	51.715	0.704
0.133	0.001	1.333	0.001	0.001	0.019	1	0.014
9.789	0.098	97.890	0.097	0.100	1.420	73.424	1

Useful contact

Australia and New Zealand Industrial Gas Association (ANZIGA)

ABN 80 003 067 178

PO Box 422

Flinders Lane Vic 8099

Level 10, 10 Queen Street

Melbourne Vic 3000

Telephone: +61 3 9611 5412

Email: office@anziga.com

For more information on any BOC products or services contact
the BOC Customer Service Centre on:

131 262

Fax: 132 427

contact@boc.com

www.boc.com.au

Emergency Response Line in case of fire:

Australia

1800 653 572

BOC Limited ABN 95 000 029 729

10 Julius Avenue, North Ryde NSW 2113, Australia

www.boc.com.au

© BOC Limited 2012. BOC is a trading name of BOC Limited. Reproduction without permission is strictly prohibited. Details given in this document are believed to be correct at the time of printing. Whilst proper care has been taken in the preparation, no liability for injury or damage resulting from its improper use can be accepted.