

Tech Contributes Health

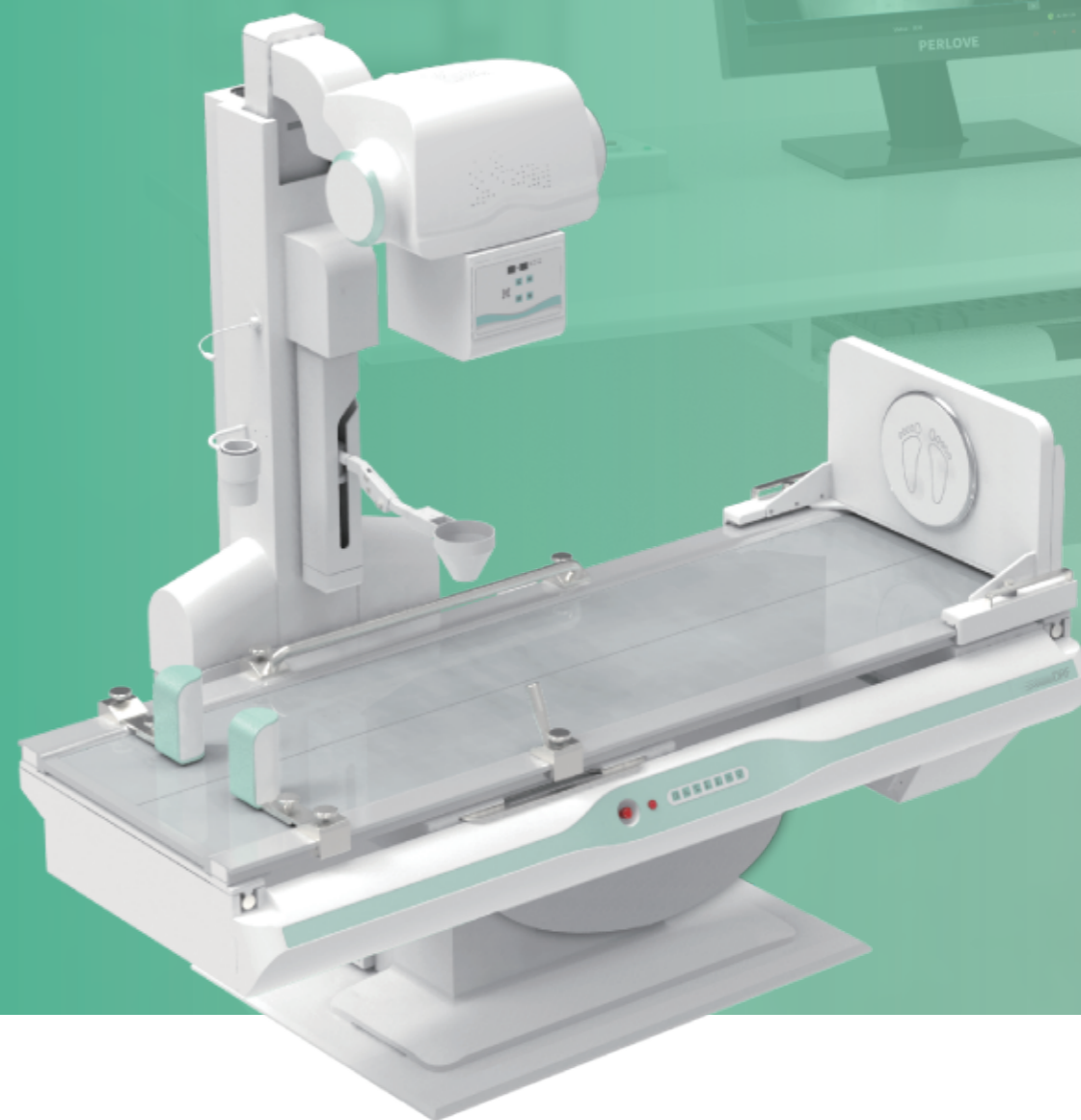

PERLOVE, WORLD OF LOVE

PLD6000 Dynamic FPD Radiography and Fluoroscopy System



NANJING PERLOVE MEDICAL EQUIPMENT CO.,LTD.

Add: NO. 97&99, Wangxi Road, Jiangning District, Nanjing, 211122, China

Tel : +86-25-87187780

+86-25-68571666 9353

Fax : +86-25-87187780

Http: //www.perlove.com.cn

E-mail: per.service@perlove.com.cn

High Performance and Intelligent

SID electrically stretched to 1.8m

- Meeting special radiography needs such as standard chest radiography and occupational pneumoconiosis examinations.

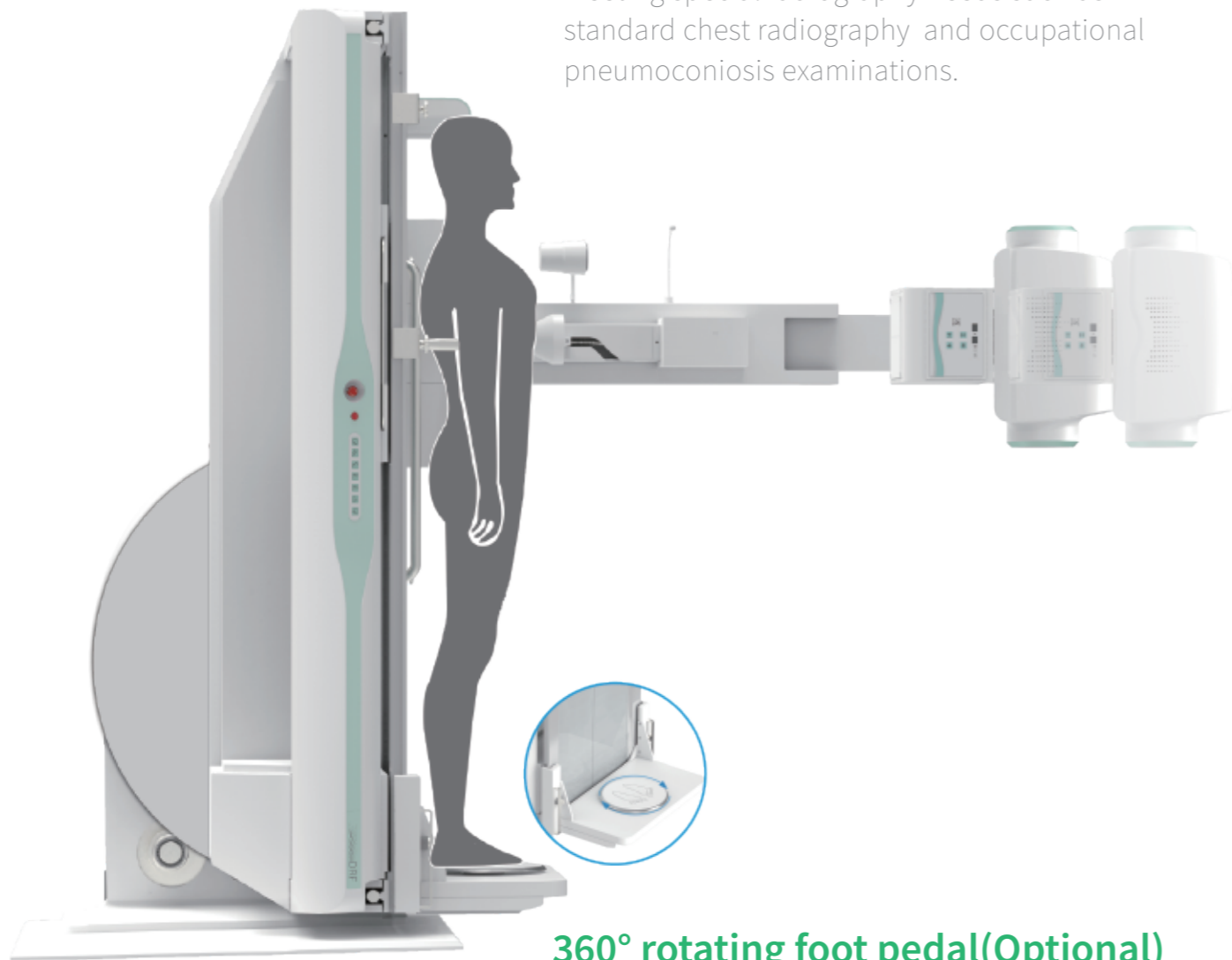

360° rotating foot pedal(Optional)

- The load-bearing capacity up to 200KG, safely and easily satisfy the inspection needs of various body types.

Digital radiography

- Suitable for radiography of all body parts

Digital fluoroscopy

- Suitable for fluoroscopy of all body parts

Digital radiography with contrast agent

- Gastrointestinal tract radiography, salpingography.

Precise digital spot imaging

- Obtain high-definition images and accurately capture lesions during fluoroscopy, avoiding missed diagnoses and misdiagnosis caused by blind shots.



Table rotates in a wide range to meet the needs of different body positions.



Table horizontally moving, reduce movement of patients.



The spot film device move longitudinally in a wide range, cover whole body parts' examinations.

High Performance and Intelligent

Automatic stitching function - accurate and precise(Optional)

- Panoramic images of full spine, full lower limbs
- Accurate measurements of preoperative planning and postoperative surgery
- One-step radiography, providing more reliable diagnostic basis for clinical practice

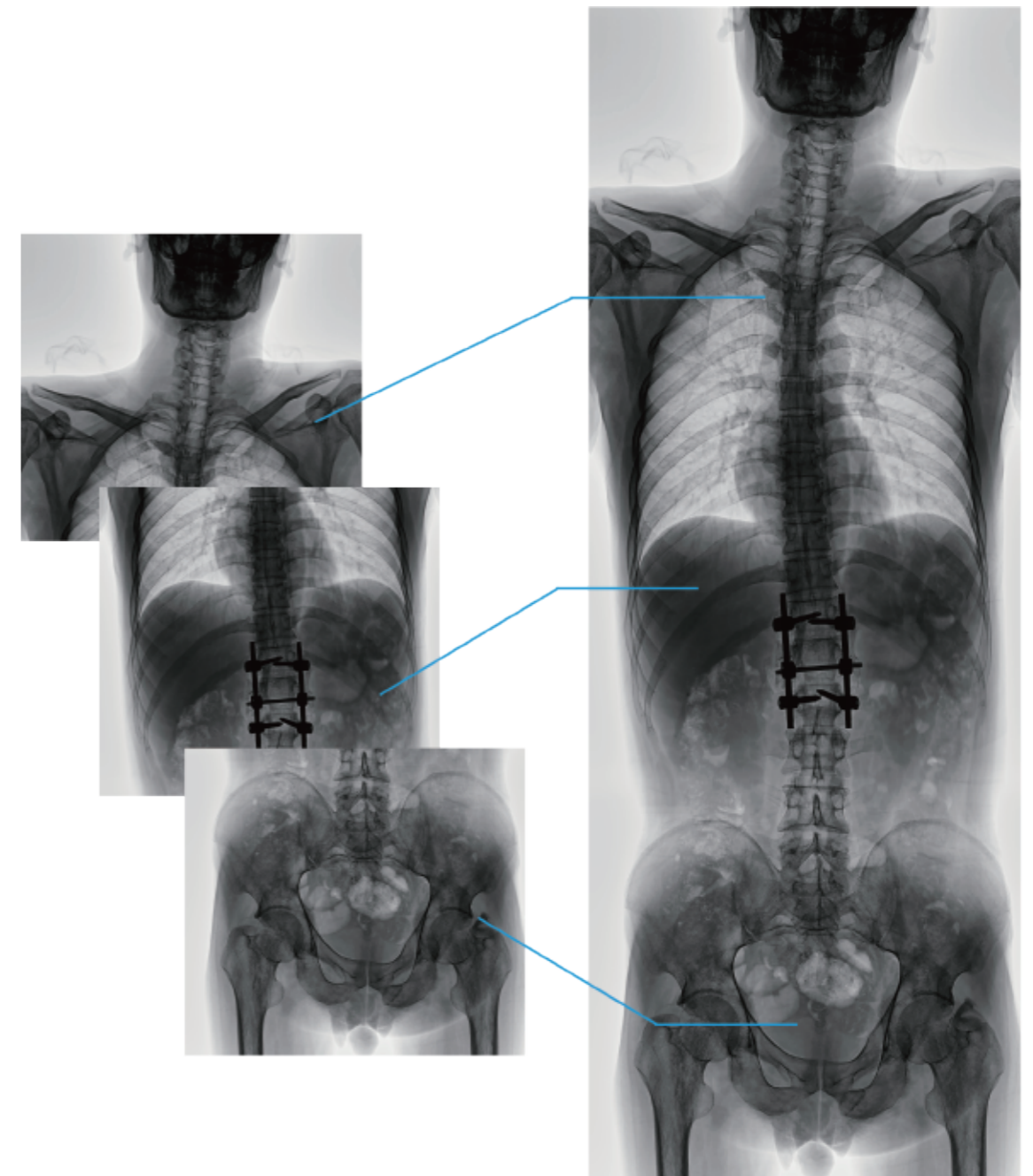
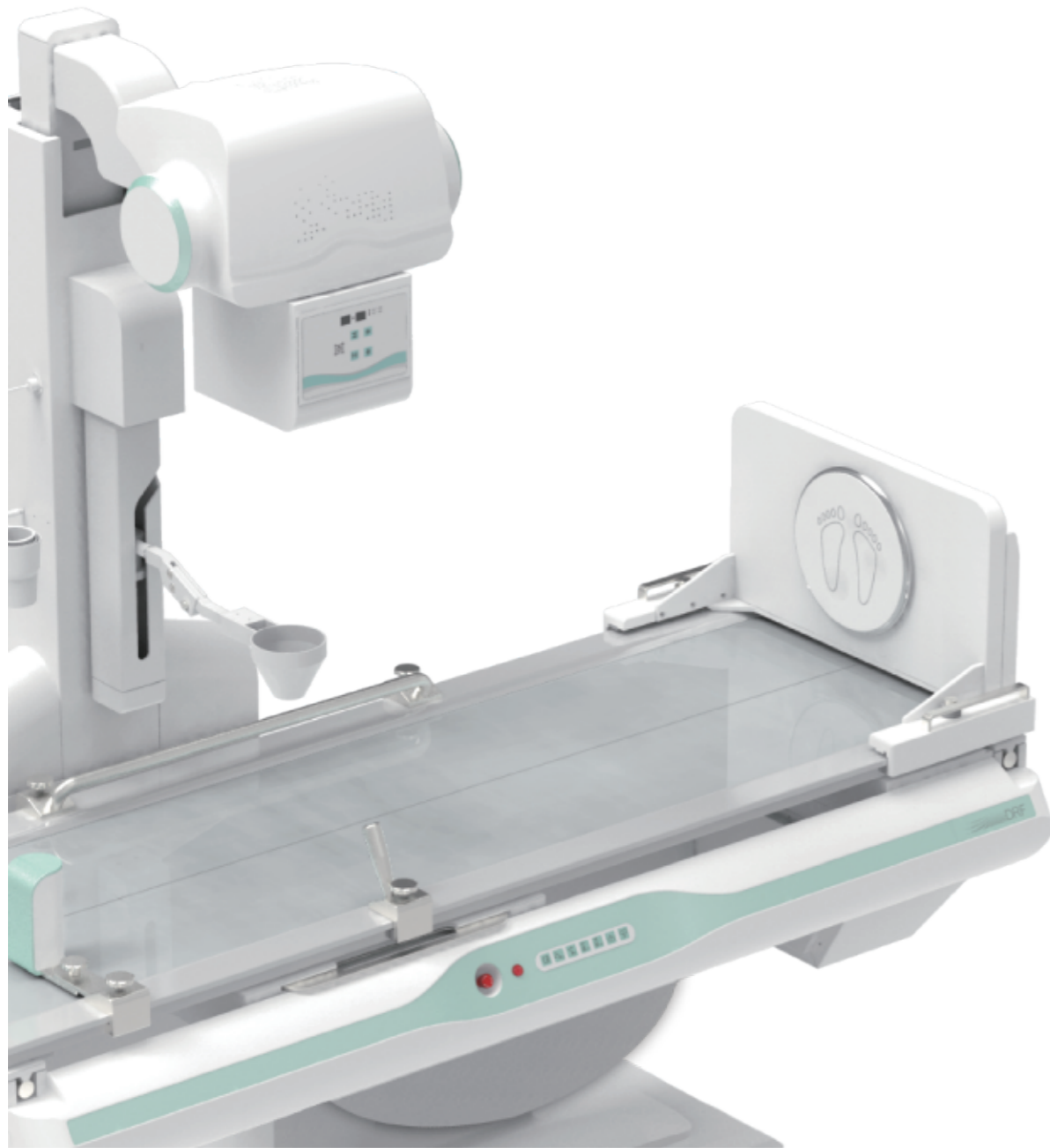

Cloud Image Interconnection

DAP - Dose visualized, safety assured(Optional)

- The pioneer usher in intelligent radiation dose monitoring system
- Synchronous dose monitoring system of hardware and software, guaranteeing more accurate diagnosis

KVP: 88.00
ms: 80.00
mAs: 10.00
DAP: 41.5346uGy.m²

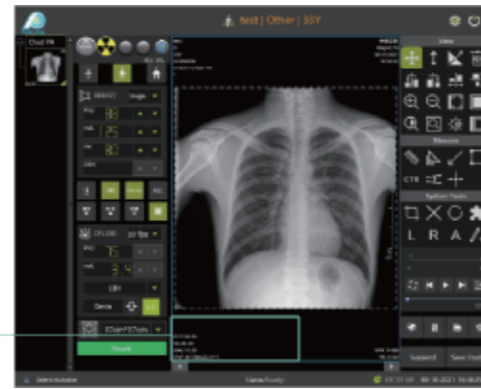

Pulsed fluoroscopy - Low dose and sharp images

- Multiple fluoroscopy modes
- Instant exposure
- Lower dose to protect doctors and patients

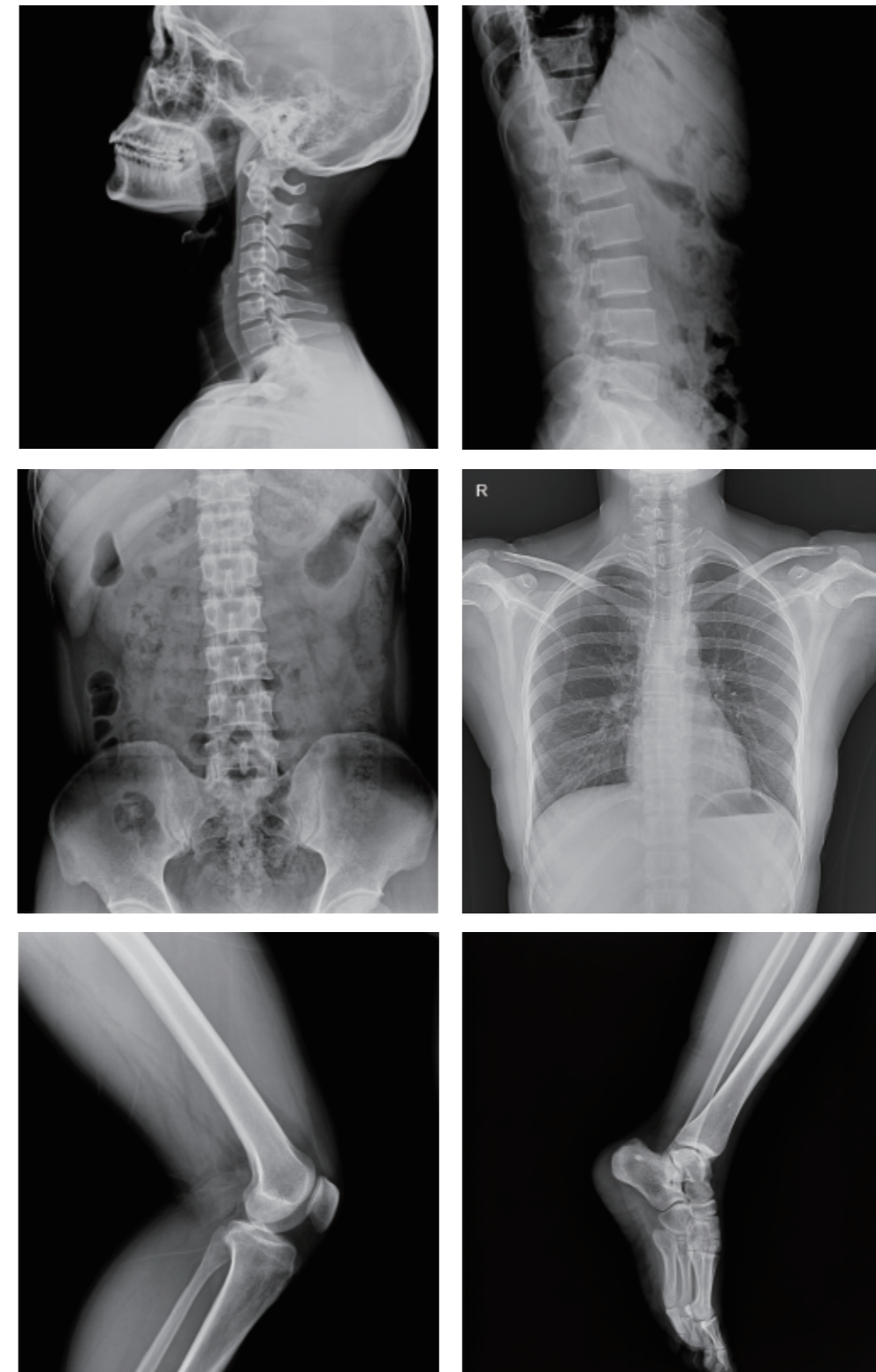

Stable and Reliable Image Chain



Self-developed ultra-high frequency and high voltage generator

- Good X-ray source
- Strong penetration ability
- Low-dose radiation
- Stable performance
- High-quality image
- High efficiency



Imported high-quality X-ray tube

- Large heat capacity
- High rotate speed of X-ray tube
- Suitable for long time and high-intensity work
- Have long service life

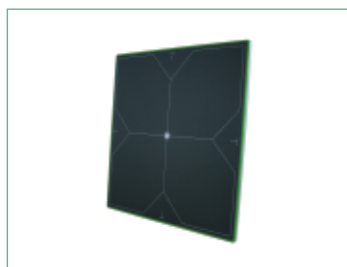

Dynamic flat panel detector

- Standard high-resolution dynamic flat-panel detector

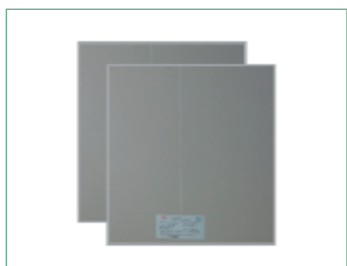

Removable dual grid

- Removable grid for reducing radiation
- Designed for pediatrics

Certifications- ISO approved

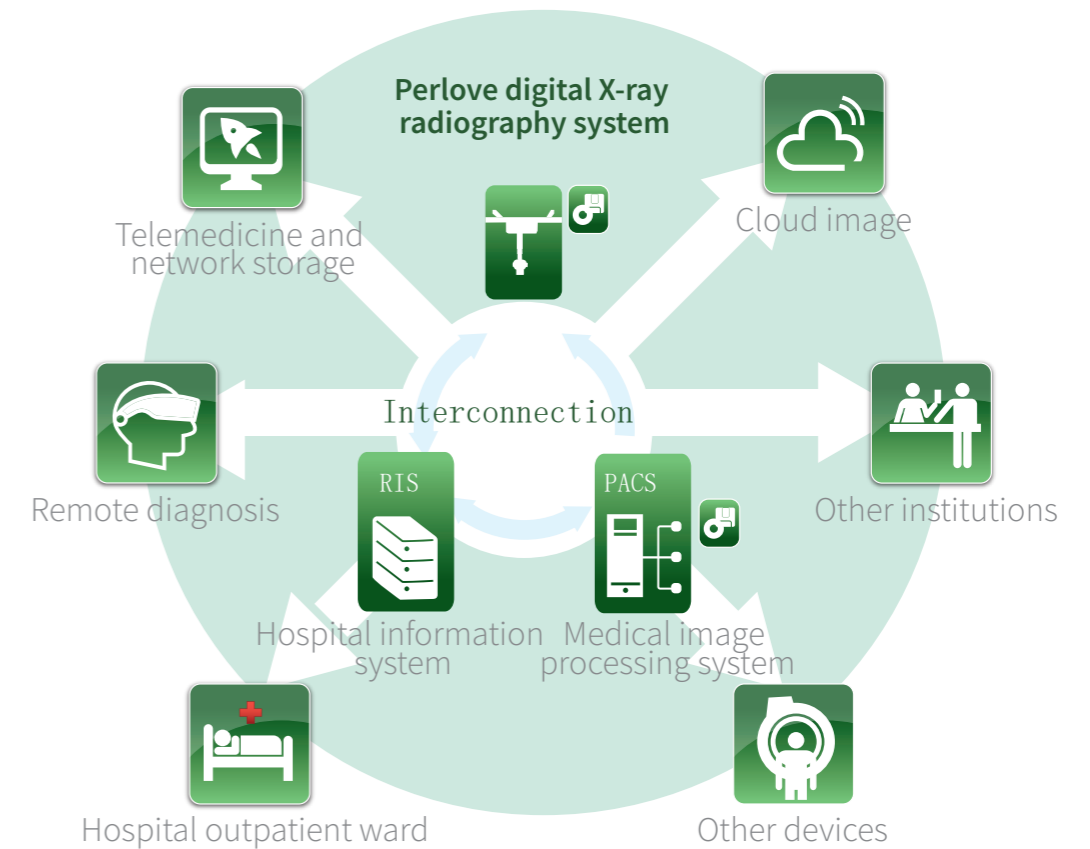

- The system can be maintained remotely, it can perform fault self-diagnosis and display function quickly and accurately determine the fault status and has self-protection function.
- It can share information with PACS system, bring benefits for remote diagnosis.