

INSTALLATION MANUAL

Tools You Will Need:

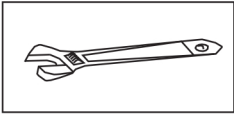

Adjustable wrench

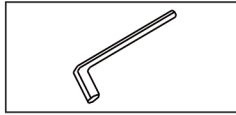

Hexagon wrench

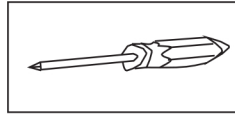

Philips Screwdriver

Model: SS2201

Before the Installation

1. Check the package and confirm all parts are included. If any part is missing or damaged, please contact us.
2. Do not disassemble the main body, as it has been installed & commissioned correctly & precisely before leaving the factory.
3. Shut off the main water supply prior to beginning installation.
4. Do flush the water supply lines to remove any dirt and debris before installation (IMPORTANT).
5. Make sure to connect the hot/cold inlet pipe correctly. If standing in front, connect hot water pipe to the left and cold water pipe to the right.
6. After the installation, check for leaks and make sure every joint is safely sealed.

Cleaning and Maintenance

1. Rinse with clean water and dry with a soft cloth.
2. Do not use any detergent, acid, polisher, abrasives, or harsh cleaners.
3. Do not use cloth with a coarse surface.

Parts List

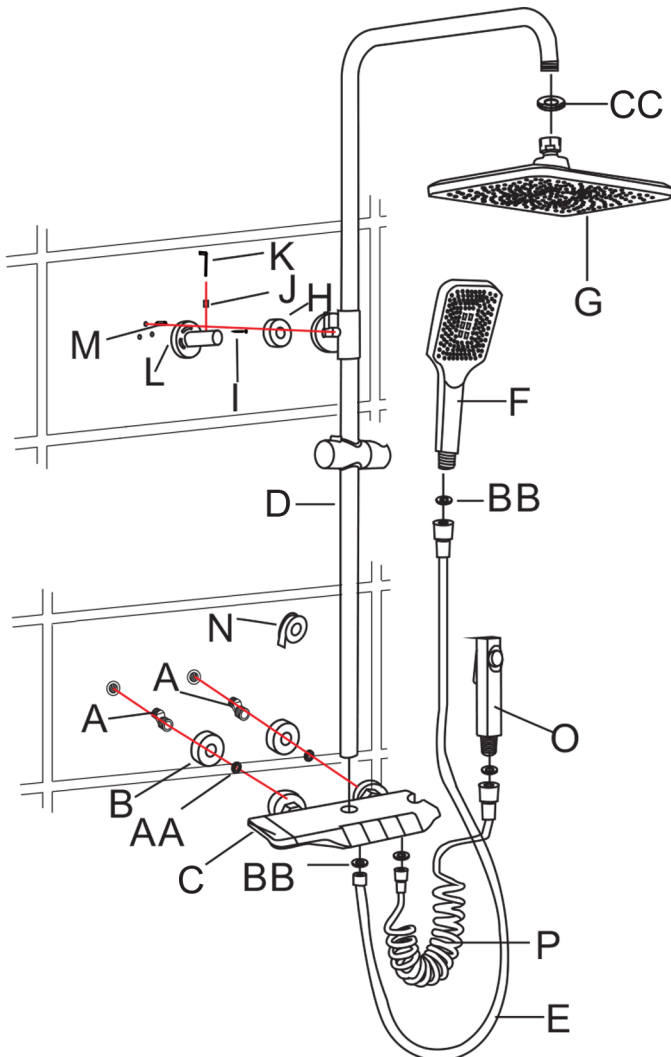

Part	Name	Quantity
A	S-union	2
B	Escutcheon A	2
C	Valve body	1
D	Riser	1
E	Hose A	1
F	Handshower	1
G	Showhead	1
H	Escutcheon B	1
I	Screw	1
J	Set screw	1
K	Alley key	1
L	Mounting plate	1
M	Anchor	1
N	Teflon tape	1
O	Handheld sprayer	1
P	Hose B	1
AA	Rubber washer A	2
BB	Rubber washer B	4
CC	Rubber washer C	1

Installation Guide

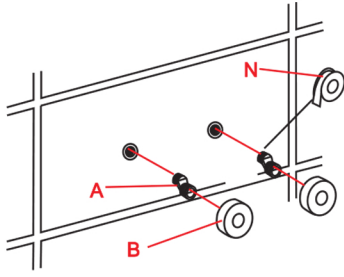

1. Wrap the threads of the s-union (A) with Teflon tape (N). Screw the s-union (A) into the female fittings of water suppliers. Make sure that the s-union (A) are level. Install the escutcheon A (B) to the s-union (A).

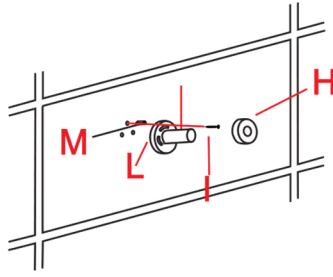

2. Drill the hole and install the anchor (M). Fix the mounting plate (L) to wall with screw (I), then put on the escutcheon B (H) to the mounting plate (L).

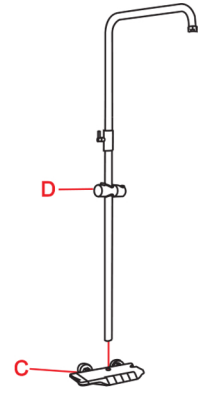

3. Screw the riser (D) into the valve body (C).

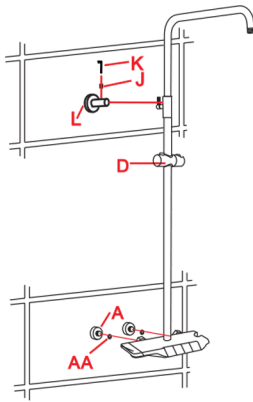

4. Fix the rubber washer A (AA) into the inlets on the valve body (C). Install the connecting threads on the s-union (A). Then, locate the riser (D) assembly into the mounting plate (L) and tighten the set screw (J) with the Alley Key (K).

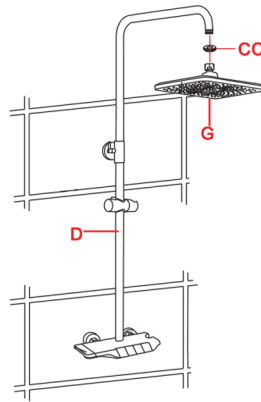

5. Put on the rubber washer C (CC) to the showerhead (G) and thread the showerhead (G) into the riser (D).

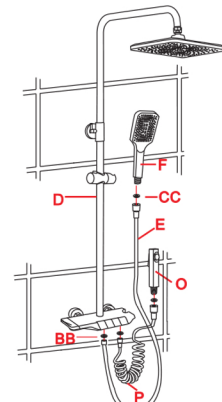

6. Install the handshower (F). Place rubber washer B (BB) in both ends of the hose A (E). Screw one end into the bottom of the valve body (C) and the other end into the handheld sprayer (O). Place rubber washer B (BB) in both ends of the hose B (P). Screw one end into the bottom of the valve body (C) and the other end into the handheld sprayer (O).

Troubleshooting

Problem	Possible Cause	Corrective Action
Water does not shut off completely.	1. O-ring is not seated correctly or worn. 2. Cartridge may be defective.	1. Reseat or replace O-ring. 2. Replace cartridge.
Leaks at waterline connection.	1. Worn or broken washer. 2. Faucet body may be defective.	1. Reseat washer. 2. Replace faucet (contact us for the replacement).
Leaks from handle.	1. Cartridge may come loose. 2. Cartridge may come defective.	1. Reseat cartridge tight. 2. Replace cartridge.
Leaks at hose connection.	1. Hose connection is loose.	1. Tighten hose. 2. Replace hose.
Leaks at shower valve connection.	1. Connection may come loose or not sealed completely. 2. Defective shower valve inlet or outlet connector.	1. Check connections. 2. Replace valve body.
Diverter knob does not work.	1. Diverter cartridge may be defective.	1. Replace cartridge.
LED light does not Light or noisy LED showerhead.	1. Diverter LED generator.	1. Replace LED spray head (for kitchen faucet). 2. Replace LED threaded pipe (for separate faucet spout). 3. Replace LED generator (for others).
Low flow.	1. Check for water pressure problems. 2. Aerator may be dirty or clogged.	1. Clean or replace the aerator. 2. Remove waterflow restrictor if available. 3. Install booster or pump (if applicable).