

**LEFTON<sup>®</sup>**  
INSTALLATION MANUAL

**Single Handle Pull Down  
Kitchen Faucet**

**KF2203**

## **Congratulations on the purchase of your new Lefton plumbing fixture!**

Please keep the box and packaging materials until your product is completely installed. If you have any questions, require technical assistance or have any problems with your product:



**DO NOT RETURN TO STORE**

**Please contact our Customer Service Team  
[customer@leftonhome.com](mailto:customer@leftonhome.com)**

Have the model number available and retain a copy of your receipt with purchase date for reference.

If for any reason this product does not meet your expectations, please be sure to repack this product in the original box and packaging material to avoid damage during transit.

## Prior to Installation:

- Make sure you have all necessary parts by checking the diagram and parts list. If any part is missing or damaged, please contact Lefton Customer Service at [customer@leftonhome.com](mailto:customer@leftonhome.com) for a replacement.
- Turn off the hot and cold water supply at the angle stops and turn on the old faucet to release any built up pressure. Remove existing faucet. Clean sink or countertop to remove any debris, plumber's putty, or silicone.
- Flush angle stops to release any debris prior to installation.
- Pre-drilled hole size requirement: 1 3/8" (min)
- Max countertop thickness: 1 3/4"

## Tools Required

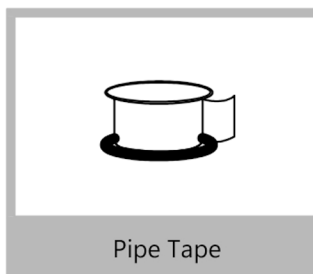
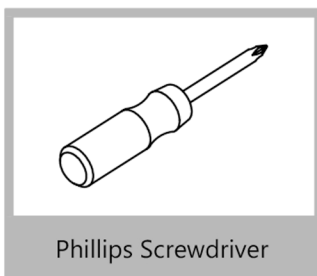
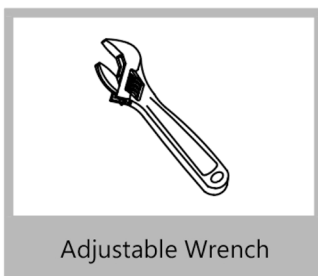

## Diagram and Parts List

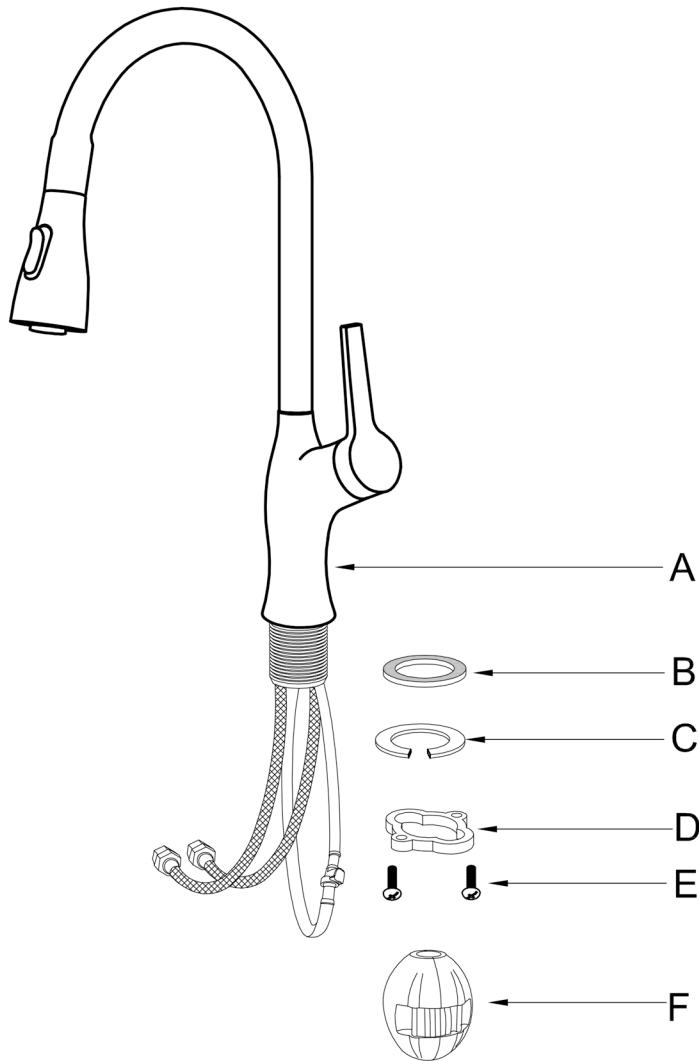

- A. Faucet Body
- B. Rubber Gasket
- C. Metal Gasket
- D. Mounting Nut
- E. Mounting Screws
- F. Gravity Hammer

## Faucet Dimension

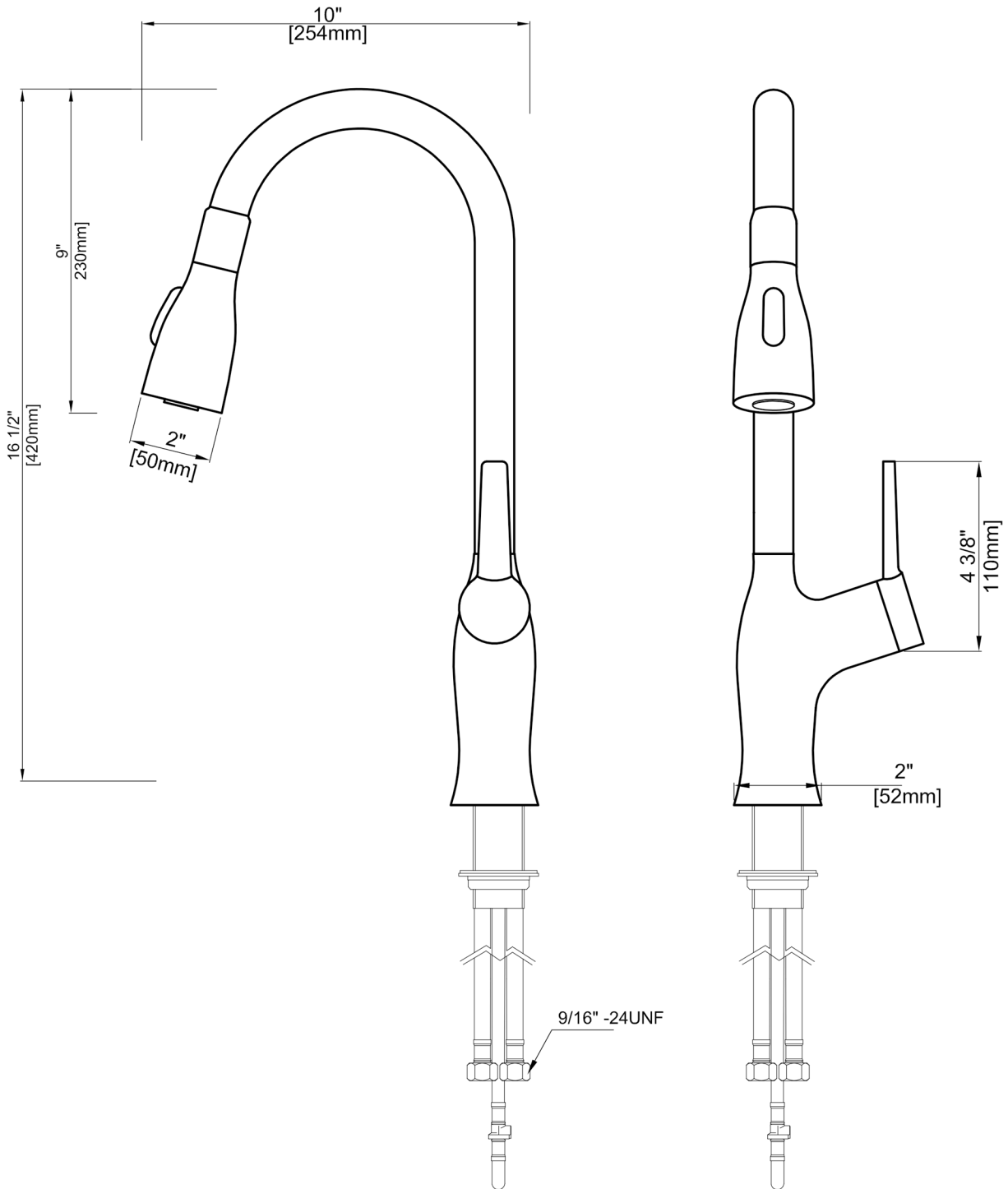

### Installer Tip:

Shut off main water supply before installing new faucet.

## Step 1. Remove mounting hardware

---

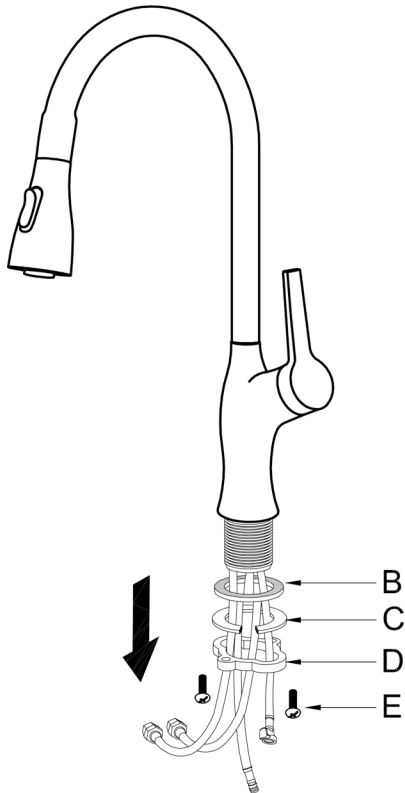

Shut off the water supply. Remove the old faucet. Clean the mounting surface. Remove mounting hardware (B~E) from the faucet.

Untie the rope of the gravity hammer as shown in the figure below.

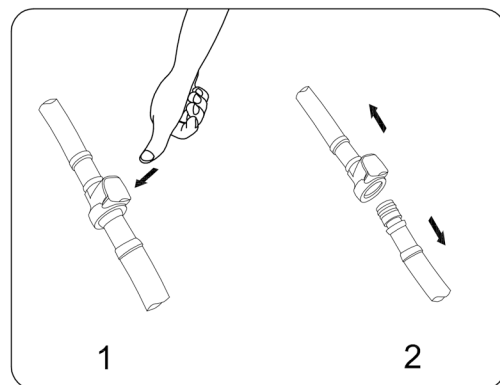

## Step 2. Installing the faucet to the countertop

---

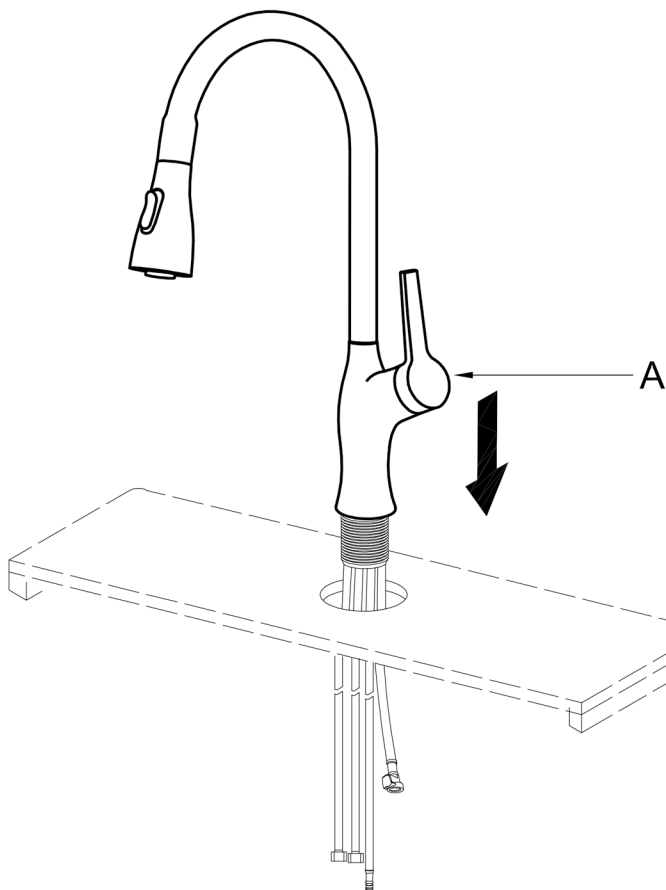

Insert faucet body (A) through the hole in the sink or the countertop.

### Step 3. Install mounting hardware

---

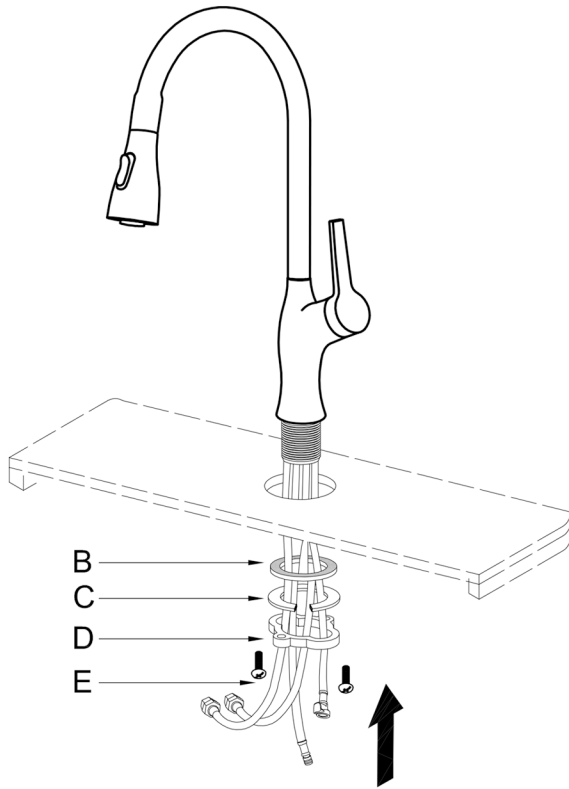

Pass the mounting hardware (B~ E) through the water pipes in turn, install them on the faucet body and tighten.

Pass the mounting hardware through the water pipes according to the figure below.

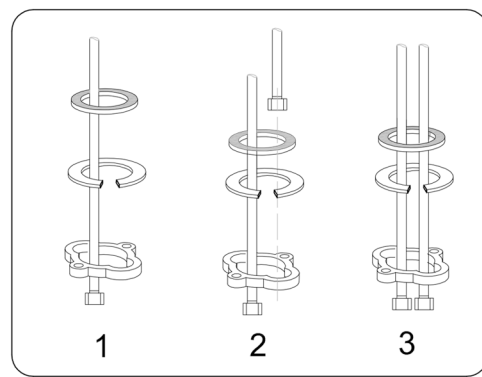

### Step 4. Reattach the gravity hammer rope

---

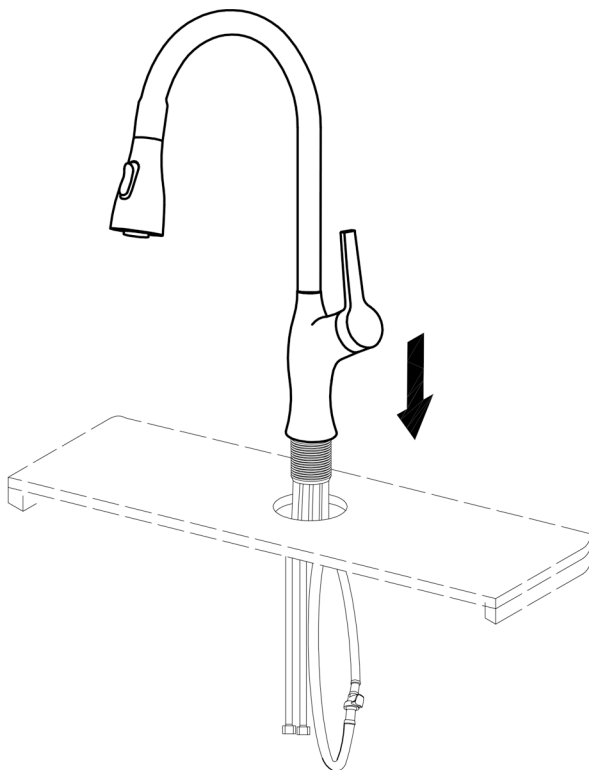

Reattach the gravity hammer rope according to the figure below.

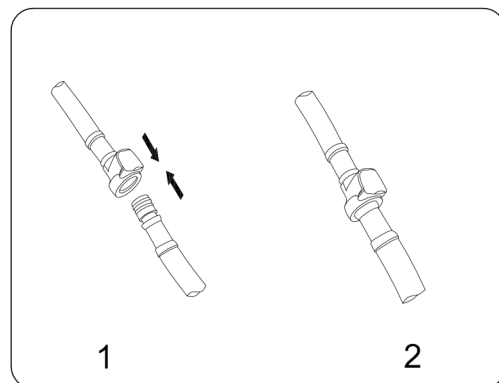

## Step 5. Install gravity hammer

---

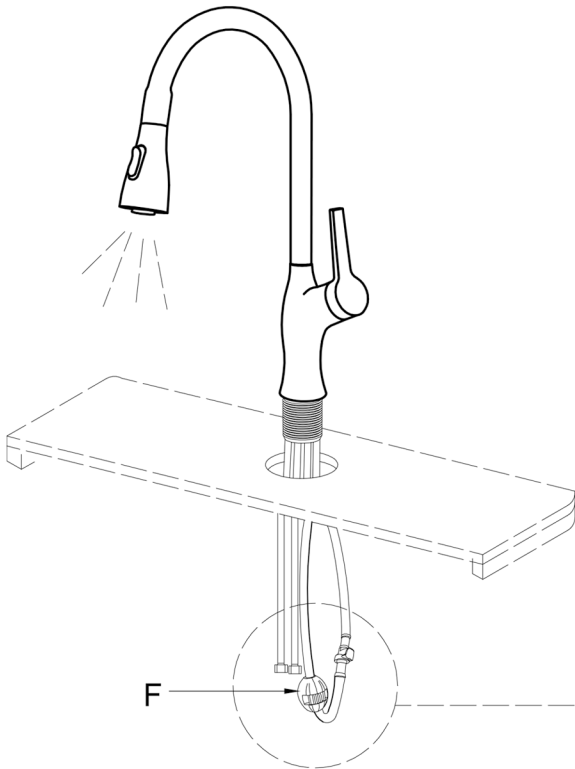

Operate the gravity hammer as shown in the picture below and attach it to the rope.

Check whether the spray can be pulled and rebounded normally. If not, please adjust the position of the gravity hammer and install and test again.

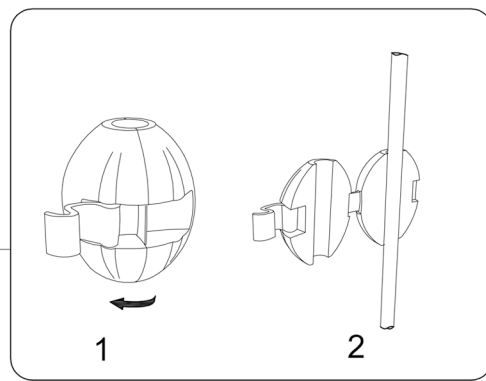

## Step 6. Turn the faucet on and check for leak

---

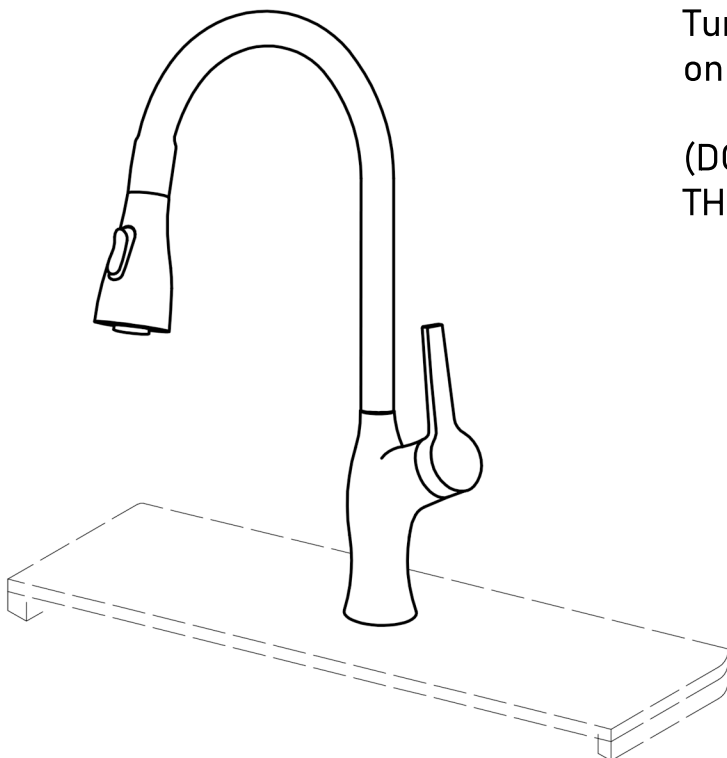

Turn on angle stops, turn the faucet on and check for leaks.

(DO NOT TURN FAUCET ON BEFORE THE INSTALLATION IS COMPLETE)



## Trouble-Shooting

If you have followed the instructions carefully and your faucet still does not work properly, take the following corrective steps:

PROBLEM	CAUSE	ACTION
Leakage under faucet handle	Bonnet nut (11) has come loose	Remove the cover button (15). Loosen set screw (14) with hex wrench (22). Remove the handle. Unscrew cap (12). Tighten bonnet nut (11) with an adjustable wrench.
The aerator has an irregular or reduced water flow	The aerator is dirty or mis-fitted	Remove the aerator and check for debris. Ensure that the rubber washer is properly installed.
The water pressure is low.	The connector underneath the deck is clogged with debris The aerator is clogged	Turn off the water supply and disconnect the connector / aerator. Unscrew the connector / aerator and clean under running water. Screw the connector / aerator back. Test water flow. If water pressure is still low then replace the connector / aerator.
There is a low flow of water.	The screen filter in the hose connectors is dirty.	Turn off the water supply at water valve and unscrew the hose connectors from water supply lines. Clean the screen in the water lines with hot water, removing any debris or calcium build up.

## Care & Maintenance

To keep the product clean & shining, follow the steps below:

1. Rinse with clean water & dry with a soft cloth
2. Do not clean with soaps, acid, polish, abrasives or harsh cleaners
3. Do not use cloth with a coarse surface
4. Unscrew the aerator and clean when necessary

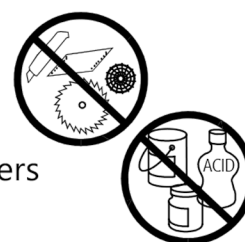

This installation manual is subject to change without further notice.

## **Warranty**

### **Section-1 - Warranty Terms**

#### **Faucets - for Kitchen, Bathroom, Shower, Tub**

##### **Non-electronic Faucets:**

Two-year Limited (residential) and One-year Limited (commercial) on the structure and finish.

Two-year Limited (residential) and One-year Limited (commercial) on the cartridge.

One-year Limited (residential and commercial) on the mechanical components such as but not limited to sprayhead assembly (includes engine, aerators, structure, restrictors, back flow preventers, sprayer hoses, braided supply line hoses which encompasses nylon, silicon and stainless steel, etc), LED function.

##### **Electronic Faucets:**

Two-year Limited (residential) and One-year Limited (commercial) on the structure, finish, electronic parts and cartridge.

One-year Limited (residential and commercial) on the mechanical components such as but not limited to braided supply line hoses, LED function.

##### **Faucet Accessories:**

One-year Limited (residential and commercial) for drains, sink strainers, soap dispensers, escutcheon plates.

#### **Bathroom Accessories - TowelBars/Rings, Holders, Bathroom Shelves, Hooks or the like**

Two-year Limited (residential) and One-year Limited (commercial) on the structure, finish and hardware.

##### **Kitchen Sinks:**

Two-year Limited (residential) and One-year Limited (commercial) on the sink bowl.

One-year Limited (residential and commercial) on hardware and drain assembly.

## Section-2 - Warranty Agreement and Restrictions

Leftonhome.com warrants the products sold by Leftonhome.com shall be free from defects in material, workmanship and function under Normal Use on the warranty period outlined in Warranty Terms from the original date of purchase. "Normal Use" means in strict accordance with the installation, operation and maintenance manual.

If any of the warranted Products are found by Leftonhome.com to be defective in normal residential use, such Products will, at Leftonhome.com's option, be replaced, repaired or made appropriate adjustment at Leftonhome.com's cost. The parties hereto expressly agree that Original Purchaser's sole and exclusive remedy against Leftonhome.com shall be on the repair, replacement or refund of defective products as provided herein. This warranty does not cover labor or other costs or expenses to remove or install any defective, repaired or replaced product. In no event shall the liability of Leftonhome.com exceed the purchase price of the product.

This limited warranty DOES NOT cover any loss and/or damage due to:

Misuse or unusual use

Mishandling

Accident

Neglect

Acts of Relate to events outside human control, like flash floods, earthquakes, or other natural disasters.

Improper installation

Improper maintenance and Using abrasive cleaners such as powders, bleach, ammonia, alcohol, or chlorine, or steel wool, or wire brushes, as these will damage and wear down the finish. Significant product exposure to chemicals, harsh cleaners and harsh outdoor environment will void any and all warranties on finishes and material.

Modification (including but not limited to use of unauthorized parts or attachments), or adjustment or repair. This warranty only applies when all components have been provided by Leftonhome.com. Substituting another manufacturer's product and/or components will render the warranty completely void.

Normal wear and tear from daily use. For example, gloss reduction, scratching, staining and alkaline etching of finishes over time, due to use, cleaning practices or water or atmospheric conditions, are not manufacturing defects but are indicative of normal wear and tear.

This warranty extends to the original purchaser, and is not transferable whether to heirs, subsequent owners, or otherwise. No affirmation of Lefttonhome.com, by words or action, other than as set forth herein shall constitute a warranty.

If you believe that you have a warranty claim, contact Lefttonhome.com by sending an email to [customer@lefttonhome.com](mailto:customer@lefttonhome.com) and submit the return or exchange form here with the necessary info. Please be sure to provide all pertinent information regarding your claim, including a copy of your original order confirmation, confirm the item number & Qty of the defective item(s), a complete description of the problem, provide pictures or video evidence clearly showing the problem.

THE FOREGOING WARRANTY IS IN LIEU OF ALL OTHER WARRANTIES, EXPRESS OR IMPLIED INCLUDING THOSE OF MERCHANTABILITY, FITNESS ON ANY PARTICULAR PURPOSE OR INFRINGEMENT. BUYER SHALL IN NO EVENT BE ENTITLED TO, AND LEFTONHOME.COM SHALL NOT BE LIABLE ON, INDIRECT, SPECIAL, INCIDENTAL OR CONSEQUENTIAL DAMAGES OF ANY NATURE, INCLUDING, BUT NOT LIMITED TO, TO LOSS OF PROFIT, PROMOTIONAL AND/OR MANUFACTURING EXPENSES, OVERHEAD, INJURY TO REPUTATION AND/OR LOSS OF CUSTOMERS.

This warranty relates to defects in manufacture, materials, or workmanship in a Leftton sink or faucet supplied for install on residential. It does not extend to:

Damage resulting from failure to maintain the product in accordance with the Care and Maintenance instructions provided with the product

Normal wear and tear, scratches, or accidental damage

Faults arising from improper use and/or installation

Defects in accessories, strainers, and rinse grids

**LEFTON**

Enjoy Smart and Creative Life

**THANK YOU!**



[www.leftonhome.com](http://www.leftonhome.com)