

**CAT LINK**

# CATLINK AI Water Fountain

**PURE2** User Manual



v1-20220727

Toll free: +1 833 440 2772 Email: [support@catlink.cn](mailto:support@catlink.cn)

# Health Monitoring Water Purifying

## 01 Important

- Thank you for purchasing CATLINK AI Water Fountain - PURE2. CATLINK will, as always, put pet safety, health and service experience first.
- Please read this user manual carefully before use. Once the product is used, it means that the following safety precautions have been carefully read and accepted.
- CATLINK is not responsible for any accident or loss caused by illegal operation and assumes no legal responsibility.
- The right to interpret and modify this statement belongs to CATLINK.

## 02 Important Safety Instructions

Failure to comply with the following terms may result in product failure or other accidental damage.

- ① Please assemble and use the product in strict accordance with the instructions.
- ② Please use this product indoors, avoiding high temperature, high humidity and direct sunlight.
- ③ This device uses a low-voltage 5V power supply. Pets will not get electrocuted by biting wires, but it will cause leakage. Please guide your pet to use this product correctly.
- ④ Please use the original adapter, otherwise it will damage the device or cause safety hazards.
- ⑤ Please place the device on a dry, stable and level floor. Keep it horizontal and do not overturn it, otherwise the device will not work properly.
- ⑥ The base of this product should not be immersed in or soaked in water.
- ⑦ If children use this device, be sure to use it under the guidance of an adult.
- ⑧ Please carry out maintenance under the guidance of professionals to avoid accidental injuries.
- ⑨ In order to provide a better experience, we will regularly carry out product upgrades. The actual equipment or related functions may be different from this manual.
- ⑩ Feel free to contact us if you have any problems.

## 03 Package List

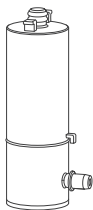

Ultrafiltration  
Filter x1

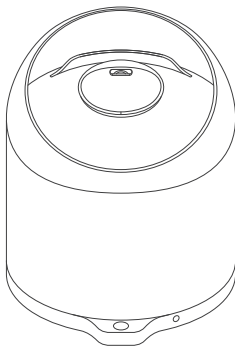

Ultrafiltration  
AI Water Fountain x1

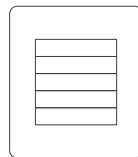

Foam Filter (White) x5



User Manual x1



Quick Start Guide x1



Adapter x1

## 04 Device Structure

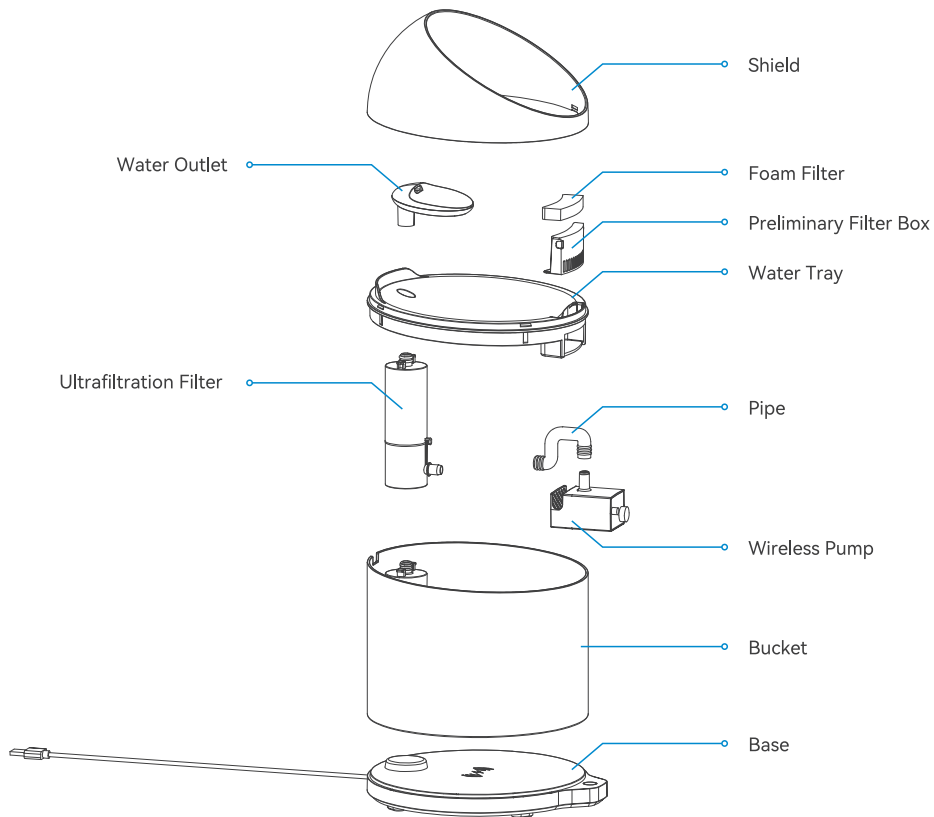

## 05 Button Functions

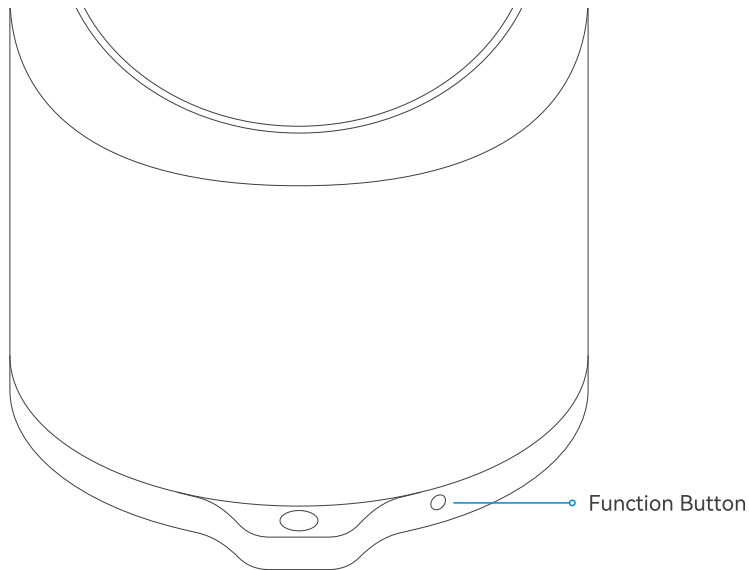

Button	Operation	Function
Function Button	Press and hold for about 5 seconds, release when hearing 2 beeps.	Enter wifi setting mode
	Long press for about 15 seconds, you will hear 2 beeps first, release when hearing the third beep.	Activate the filter

## 06 Indicator Lights

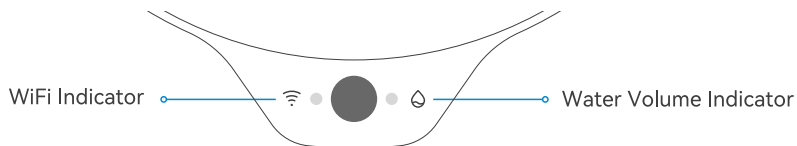

Indicator	Indicator status	Device Status	Sound
WiFi Indicator	<b>On</b>	<b>WiFi Connect</b>	
	Slow Flash	Enter WiFi Setting	2 Beeps
	Fast Flash	WiFi Connect Failed	
	<b>Off</b>	<b>Wifi Not Connected</b>	
	Flash 3 Times	Cat Detected	
	Flash 1 Times	Mode Switch	1 Beep
Water Volume Indicator	<b>Green Light On</b>	<b>Enough Water</b>	
	<b>Red Light Fast Flash</b>	<b>Insufficient Water</b>	
	<b>Red/Green Flash Alternately</b>	<b>Filter Expired</b>	
	Yellow Light Fast Flashes	Water Pump is Blocked	
	Red Light On	Water Pump Not in Place	



## 07 Device Setting

### WiFi connection



IOS



Android

- ① Search “CATLINK” in app store, or scan the QR code, download and install CATLINK APP.
- ② Connect your phone to 2.4G Wifi. The App currently does not support 5GHz, and WiFi that requires special certification such as hotels and airports.  
*\*Note: The WiFi name cannot contain spaces or other special characters, otherwise it will affect the WiFi connection.*
- ③ Open the CATLINK APP, register an account and log in, click **【Devices】** , add a water fountain and follow the prompts.  
*\*Please turn on the mobile phone's Bluetooth and allow location access; Android phone also needs to turn on GPS.*
- ④ Press and hold the function button for 5 seconds, release the button after you hear 2 beeps and see the blue Wifi indicator flashing.  
*\*Please keep the water fountain as close to the router as possible, and make sure the water fountain is powered on.*
- ⑤ Follow the instructions of the APP to operate.
- ⑥ After completing the above steps, all functions of the water fountain can be used.  
*\*If the WiFi setting fails, please try again patiently and check whether the WiFi password is entered correctly. If the wifi setting fails many times, please contact the after-sale service for assistance.*

## 08 Working Mode

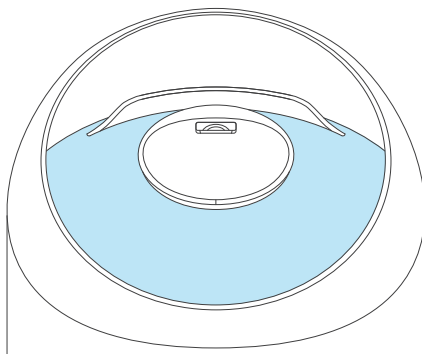

\*Please switch the Mode in CATLINK APP.

The button is only used when pairing WIFI and activating the Filter

Mode	State
Flowing Mode	Keep flowing water to attract cats to drink water to the greatest extent. (Recommend)
Eco Mode	Flowing water for 3 minutes every 5 minutes, suitable for timid cats.
Smart Mode	It is an Eco Mode when in standby, and turns into a Flowing Mode when it detects a cat approaching. Stimulate the cat's curiosity and interest in drinking water.
Night Mode	Under Night Mode, the device switches to Eco Mode, and the indicator light turns off.

## 09 Installation Instructions

### ① Install the Ultrafiltration Filter

Please clean the Bucket and related parts before use.

(\*Do not wash the Base, keep it dry.)

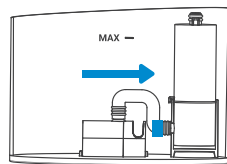
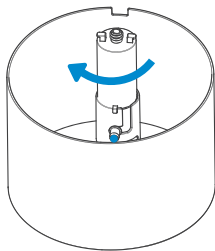
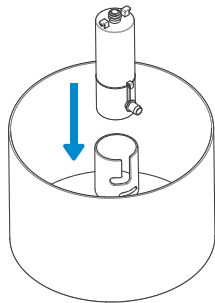

**1** Put the Ultrafiltration Filter along the groove inside the Bucket.

**2** Rotate the Ultrafiltration Filter to the left until it reaches the end of the groove.

**3** Install the Water Pump Pipe to the Filter Inlet.

## 09 Installation Instructions

### ② Add Water

Fill the Bucket with water up to the Max line.

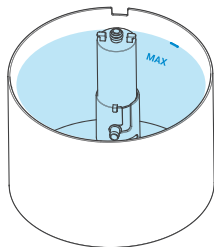

### ③ 3. Install Tray, Water Outlet, Preliminary Filter Box

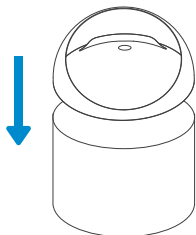

1 Install the Water Tray.

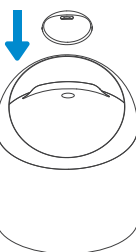

2 Install the Water Outlet, Insert the Water Outlet as far as possible to fix the Water Tray.

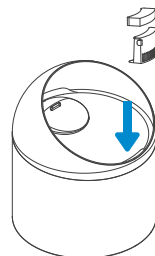

3 Install the Foam Filter at the bottom of the Preliminary Filter Box, and then install the Preliminary Filter Box to the Water Fountain.

## 09 Installation Instructions

### ④ Power On

Power on the Base and place the Bucket on the Base.

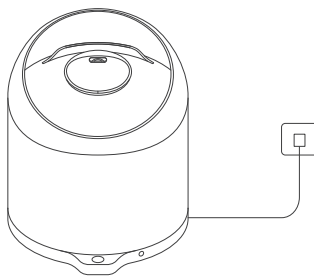

## 10 Product Cleaning

### Cleaning and Attention

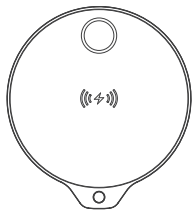

① Do not wash the Base, keep it dry.

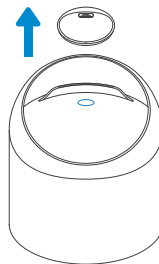

② Before disassembling and cleaning, please pull out the Water Outlet.

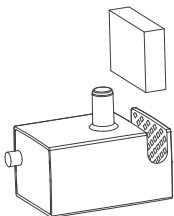

- 3** It is recommended to disassemble and clean the Water Pump every 7 days.

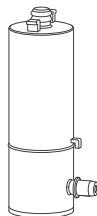

- 4** It is recommended to simply rinse and dry the Ultrafiltration Filter with clean water every 7 days.

## 11 Replace Ultrafiltration Filter

### Replacement Cycle

- The service life of the Ultrafiltration Filter is 3 months, please replace it every 3 months.
- When the service life of the Ultrafiltration Filter expires, in the state of sufficient water, the Water Volume Indicator will flash alternately red and green. In addition, you can also view the Ultrafiltration Filter usage in real time on APP

### Activate the Ultrafiltration Filter

- ① Install new Ultrafiltration Filter
- ② In the state of sufficient water, press and hold the button for 15 seconds until the water indicator light stop flashing, which means the Ultrafiltration Filter is activated.

## 12 Replace Foam Filter

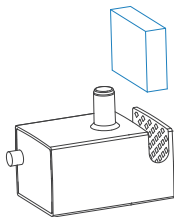

- 1 It is recommended to replace (or clean once) the Water Pump Foam Filter (black) once a week.

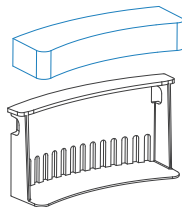

- 2 Preliminary Filter Box  
It is recommended to replace the Foam Filter (white) of Preliminary Filter Box once a week (Repeated cleaning is not recommended)

## 13 Other Accessories

### Smart Collar (Only for PRO version)

- CATLINK Smart Collar - CoNet (sold separately), only for PRO version Water Fountain Pure 2, for multi-cat identification.

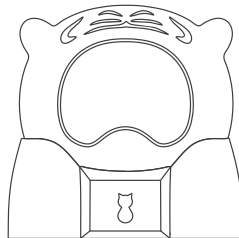

## 14 Product Specifications

Name	CATLINK AI Water Fountain - PURE 2
Model	CL-WA-01
Main Material	ABS
Total Capacity	2.6 L
Size	7.48 * 7.48 * 9.53 inch
Rated Voltage	5V ==
Rated Power	3W
Target Audience	Cats and small dogs
Weight	2 lb
Carried Standard	GB 4706.1-2005
Website	<a href="http://www.catlinkus.com">www.catlinkus.com</a>
Toll Free	+1 833 440 2772



## **15** Customer Service

We will provide customers with a one-year free warranty service.  
If you have questions or need assistance, contact us!

### **Phone Support**

+1 833 440 2772

Mon-Fri: 10AM-6PM EST

### **Email Support**

support@catlink.cn 24/7







Toll free: +1 833 440 2772 Email: [support@catlink.cn](mailto:support@catlink.cn)