



# Automatic Feeder

FRESH 2 User Manual



Toll free: +1 833 440 2772 Email: [support@catlink.cn](mailto:support@catlink.cn)

## **Thank you for purchasing a CATLINK Automatic Feeder - FRESH 2!**

CATLINK is dedicated to developing innovative pet products that bring joy to your furry friends and simplify your daily routine. This manual is a guide to help you get the most out of your Fresh 2, providing detailed instructions on setting up your Fresh 2 and offering valuable tips and advice.

This manual applies to both the Standard and Pro versions of FRESH 2. The Pro version is designed to recognize multiple cats, while the Standard version can only recognize one cat.

Our FRESH 2 is packed with many features, so be sure to keep this manual handy for future reference. If you require assistance or have any questions, please don't hesitate to reach out to us at [support@catlink.cn](mailto:support@catlink.cn) or call us at +1 833 440 2772.

We hope you and your pets enjoy the freedom that comes with our FRESH 2.

CATLINK

## 02 Important Safety Instructions

- ① To properly install and use FRESH 2, it is important to strictly follow this manual.
- ② Only use the recommended adapter to power the device to prevent damage, malfunction, or potential security risks.
- ③ To prevent damage to the device or shorten its service life, use it indoors and keep it away from sources of fire, high temperatures, high humidity, or direct sunlight.
- ④ Keep any objects at least 8 inches away from the front of the device to avoid interfering with your cat's eating experience or the device's proper operation.
- ⑤ Do not manually press the bowl as this may affect the weighing accuracy and feeding mechanism.
- ⑥ After cleaning the bowl, gently place it back on the device once it has dried. Make sure to align it correctly and re-zero the calibration.
- ⑦ If your FRESH 2 will not be used for an extended period, remove the battery, clean the device, pack the parts in the original order, and store in a dry place.
- ⑧ Do not immerse the device in water. Instead, turn it off, clean it with wet wipes, and allow it dry completely before turning it back on. Avoid using gasoline, alcohol, or other chemicals, as this may cause damage.
- ⑨ Please note that the device or related functions may differ from those described in this manual as we continue to improve it. For any questions, refer to the latest e-Manual in the CATLINK app.
- ⑩ This device complies with Industry Canada licence-exempt RSS standard(s). Operation is subject to the following two conditions:
  - (1) this device may not cause interference, and
  - (2) this device must accept any interference, including interference that may cause undesired operation of the device.

# Table of Contents

① Packing List	1	④ Feeding Mode	7
② Product Structure	2	⑤ Button Functions	8
③ Setting Up Your Feeder - FRESH 2	4	⑥ Indicator	9
1. Placement	4	⑦ Desiccant	10
2. Power-on the Device	4	⑧ Backup Battery (Optional)	10
3. Installation of Bowl and Tray	5	⑨ How to Clean	11
4. Adding Food	5	⑩ Product Specifications	13
5. Wi-Fi Connection	6	⑪ Model Comparison	14
6. Scale Reset	7	⑫ Customer Service	15

# 01 Packing List

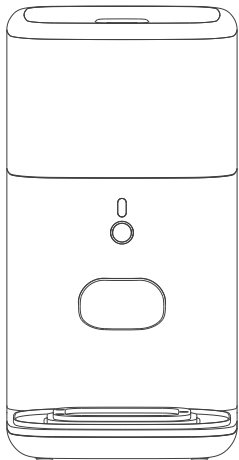

Automatic Feeder - FRESH 2 x 1

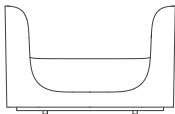

Tray x 1



Bowl x 1



Adapter x 1



Power Cable x 1



Desiccant x 1



Collar x 2



Tag x 2



User Manual x 1

**\*Only the Luxury version comes with the Collar and Tag.**

## 02 Product Structure

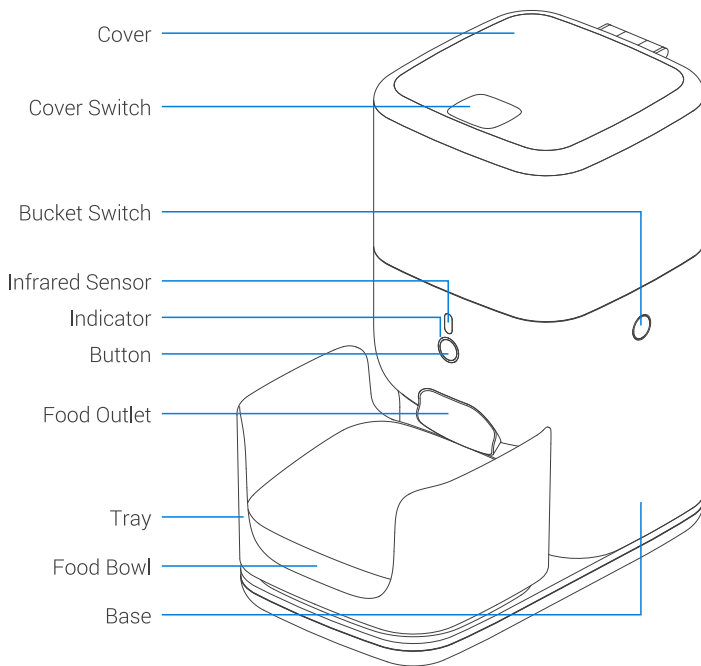

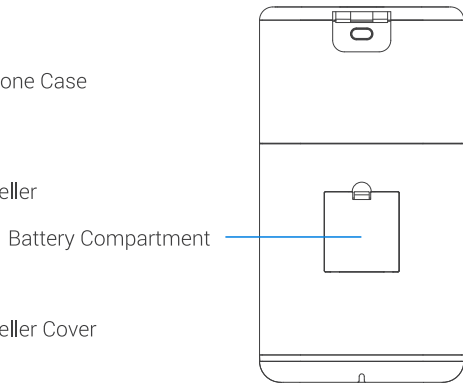
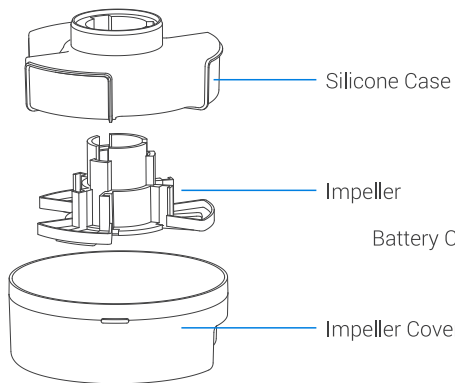
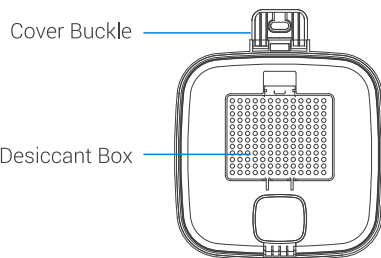
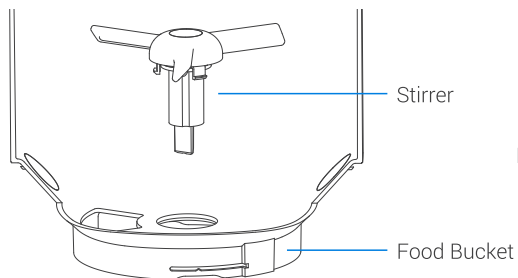

## 03 Setting Up Your Feeder - FRESH 2

### ① Placement

- Make sure that the unit is positioned on a flat and stable surface, protected from light and moisture.
- Place it in a location where it can consistently receive a strong Wi-Fi signal.
- Ensure that there are no obstructions within 8 inches in front of the sensor to prevent interference.
- Keep the power cord as close to the power socket as possible to avoid potential safety hazards.

### ② Power-On the Device

- Plug in the unit as shown on the right side.

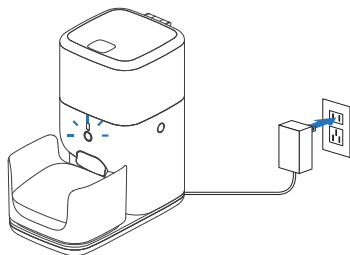
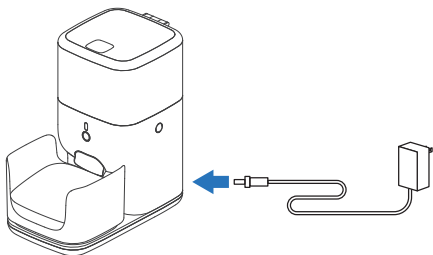



### ③ Installation of Bowl and Tray

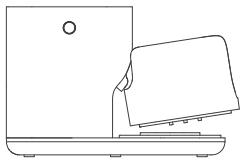

Tilt the Tray approximately 30° from the bottom of the Food Outlet.

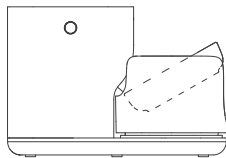

Tilt the Food Bowl approximately 30° from the bottom of the Food Outlet.

### ④ Adding Food

- The unit is compatible with cat food with a maximum size of 0.63 inches. If the size is too large, there is a certain risk of food jam.
- It supports mixed feeding of freeze-dried and other cat dry food. Since freeze-dried is less dense than other cat dry food, there will be uneven food output to varying degrees. To ensure even dispensing, stir the cat food regularly.
- In the event of a food blockage, the unit's motor will automatically reverse three times in an attempt to clear it. If the blockage cannot be resolved, the unit will promptly notify you, and it is important to remove the blockage manually to prevent any potential damage to the unit.
- Do not use chipped cat food. Special-shaped cat food is not recommended.

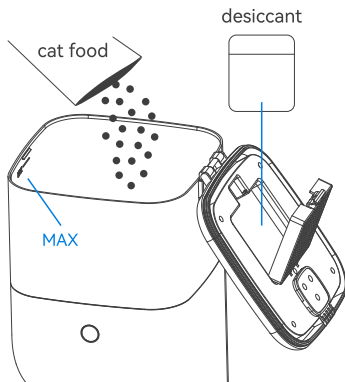

## ⑤ Wi-Fi Connection

### NOTE:

- Place the unit as close to the router as possible and make sure it is powered on.
  - Authorize the location information, and turn on GPS on your Android phone.
  - Use only letters and numbers for the Wi-Fi name to ensure a stable and reliable connection.
  - Use a 2.4GHz Wi-Fi network to connect the unit. 5GHz Wi-Fi is not supported, and certain locations such as hotels and airports that require special Wi-Fi certification may also not be supported.
- ① Download the CATLINK app from your phone's application market or scan the QR code.



CATLINK app



IOS/Android

- ② Connect your phone to 2.4GHz Wi-Fi.
- ③ Register your account in the app and log in (Make sure to authorize the location information and turn on GPS for your Android phone).

On the DEVICE page, click the "+" in the upper right corner, and select FRESH 2.

If you are unable to find the unit through the app, press and hold the Button for 5 seconds until the blue light flashes, and then click "Search" in the app.

Follow the instructions to complete the Wi-Fi connection.

- ④ After successfully connecting to the Wi-Fi, the Wi-Fi indicator on the unit will remain on.

## ④ Scale Reset

- ① Make sure the Food Bowl is empty.
- ② Make sure the Food Bowl is placed properly.
- ③ Press and hold the Button for 3 seconds. And release the Button when the indicator light turns green. The white light will turn on when the reset is complete.

### **Congratulations!**

**You have completed all the steps and your Fresh 2 is now ready to be used.**

## 04 Feeding Mode

Mode	Explanation	Note
Auto Mode (Default)	When the remaining food in the bowl is insufficient, the unit will automatically dispense more food.	The number of feedings per dispensing and the maximum number of feedings per day can be customized in the app.
Schedule Mode	Feed your pet every day based on the schedule you have set in the app.	You can program the schedule via app.

## 05 Button

Press/Hold	Function	Note
Press once	Dispense a single portion	The feeder dispenses a single portion and sounds a "beep", and the white light flashes once.
Press and hold for 3 seconds	Scale Reset	Press and hold the Button for 3 seconds. Release the Button when the indicator light turns green. The reset is complete when the white light turns on.  When you need to reset the scale to zero: 1.The pet touches the Food Bowl strongly while eating. 2.The unit has not been calibrated for a long time. The unit has not been recalibrated after cleaning.
Press and hold for 5 seconds	Wi-Fi Connection	Press and hold the Button for 5 seconds, and release it when the blue light flashes. The unit is ready to connect to Wi-Fi. If the unit is not connected to Wi-Fi within 5 minutes, it will exit the Wi-Fi setting mode.

\*Please note that the device or related functions may differ from those described in this manual as we continue to improve it. For any questions, refer to the latest e-Manual in the CATLINK app.

## 06 Indicator

Indicator Lights	Status	Explanation
White	Solid	The unit works well.
	Blinking	A cat is eating. / The unit is dispensing food.
Blue	Blinking	It is connecting to Wi-Fi network.
Red	Blinking	There is not enough food.
	Solid	There is a problem with the device. Check the app for more details.

\*Please note that the device or related functions may differ from those described in this manual as we continue to improve it. For any questions, refer to the latest e-Manual in the CATLINK app.

## 07 Desiccant

- One pack of Desiccant has been placed in the Desiccant Box. If you notice any damage to the package, replace it promptly.
- It is recommended to replace the Desiccant every 30 days. You will receive a reminder message on the app when it expires.

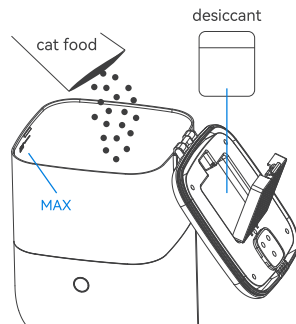

## 08 Backup Battery (Optional)

- It is recommended to use high-quality AAA alkaline batteries.
- If the app alerts a low battery warning, promptly replace the batteries.
- If there is a power outage, the device will automatically switch to battery power and enter low power mode. It will continue to dispense food based on the feeding schedule set before the outage. During this period, the device will be offline. It will briefly connect to the internet and sync data with the app when the cat eats or food is dispensed until the battery is depleted.

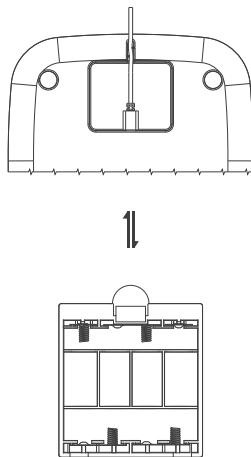

## 09 How to Clean

### ① Food Bowl

- The Food Bowl can be washed with water. We recommend cleaning it once a week. After completely drying the Food Bowl, reinstall it into the Tray and recalibrate the weight scale.
- Avoid pressing down on the high-precision component underneath the Food Bowl.

Washable

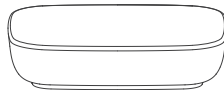

### ② Tray Washable

- Use wet wipes to clean the Tray. Avoid frequent disassembly of it.
- Avoid pressing down on the high-precision component underneath the Food Bowl.

Washable

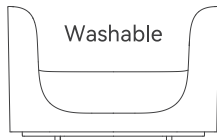

### ③ Base Unwashable

- Do not wash the Base. Instead, wipe it clean with a damp cloth.

Unwashable

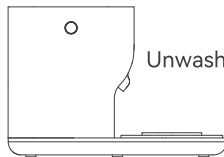

## ④ Food Bucket

- The Bucket is washable. We recommend cleaning it once a month.
- Avoid washing the Cover as it contains the Desiccant. Instead, wipe it clean with a damp cloth.

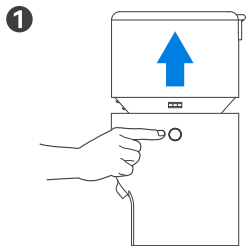

Unlock the Bucket

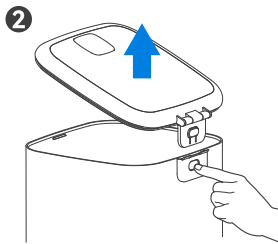

Disassemble the Cover

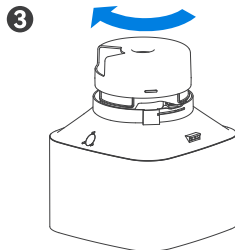

Disassemble the Impeller Cover

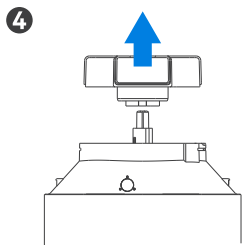

Disassemble the Impeller

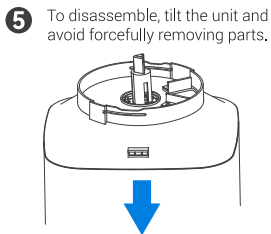

Disassemble the Stirrer

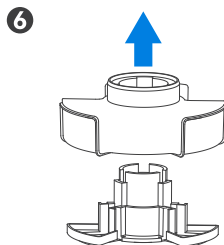

Disassemble the Silicone Case



## 10 Product Specifications

Product Name	CATLINK Automatic Cat Feeder - FRESH 2
Product Model	CL-FD-01/ CL-FD-02
Main Material	HIPS
Product Size	350*195*360 mm/13.78*7.68*14.17 inches
Rated Voltage	5V/1A
Rated Power	5W
Applicable Scope	Cats or small Dogs
Weight	6.61 lbs
Carried Standard	GB 4706.1-2005
Brand	CATLINK
Website	<a href="http://www.catlinkus.com">www.catlinkus.com</a>

## 11 Model Comparison

Version	Anti-stuck	Ceramic bowl	Triple sealing	Food lacking alert	Food weighing	Dual power supply	Multi-cat recognition
Standard	✓	✓	✓	✓	✓	✓	×
Luxury	✓	✓	✓	✓	✓	✓	✓

## 13 Customer Service

We will provide customers with a one-year free warranty service.

If you have questions or need assistance, contact us!

### Phone Support

+1 833 440 2772

Mon–Fri: 10AM–6PM EST

### Email Support

support@catlink.cn 24/7



Toll free: +1 833 440 2772 Email: [support@catlink.cn](mailto:support@catlink.cn)