

VILLA SERIES



El Series

On/Off Models

Installation & Operation
Instructions



FIRE INSPIRED®

Inspired by safety.
Innovated for your lifestyle.

**Hearth Products
Controls**



This is a Safety Alert Symbol



When you see this symbol on the fire pit insert, or in this manual, look for one of the following signal word panels alerting you to the potential for personal injury, death, or major property damage.



WARNING: For Outdoor Use Only.

Installation and service must be performed by a qualified installer, service agency, or the gas supplier.



WARNING

Do not store or use gasoline or other flammable vapors and liquids in vicinity of this or any other appliance.

An LP-cylinder not connected for use shall not be stored in the vicinity of this or any other appliance.



DANGER

FIRE OR EXPLOSION HAZARD

If you smell gas:

- **Shut off gas to the appliance.**
- **Extinguish an open flame.**
- **If odor continues, leave the area immediately.**
- **After leaving the area, call your gas supplier or fire department.**

Failure to follow these instructions could result in fire or explosion, which could cause property damage, personal injury, or death.



DANGER

CARBON MONOXIDE HAZARD

This appliance can produce carbon monoxide which has no odor.

Using it in an enclosed space can kill you.

Never use this appliance in an enclosed space such as a camper, tent, car, or home.



WARNING: Improper installation, adjustment, alteration, service, or maintenance can cause property damage, injury, or death. Read the installation, operating and maintenance instructions thoroughly before installing or servicing this equipment.



WARNING: If the information in this manual is not followed exactly, a fire or explosion may result causing property damage, personal injury, or loss of life.

⚠ DANGER • FLAMMABLE GAS UNDER PRESSURE.
LEAKING LP-GAS MAY CAUSE A FIRE OR EXPLOSION IF IGNITED
CAUSING SERIOUS BODILY INJURY OR DEATH.
CONTACT LP GAS SUPPLIER FOR REPAIRS, OR DISPOSAL OF THIS
CYLINDER OR UNUSED LP-GAS.

⚠ WARNING • FOR OUTDOOR USE ONLY.*
DO NOT USE OR STORE CYLINDER IN A BUILDING,
GARAGE OR ENCLOSED AREA.

⚠ WARNING:

- Know the odor of LP-gas. If you hear, see or smell leaking LP-gas, immediately get everyone away from the cylinder and call the Fire Department. Do not attempt repairs.
- Caution your LP-gas supplier to:
 - Be certain cylinder is purged of trapped air prior to first filling.
 - Be certain not to over fill the cylinder.
 - Be certain cylinder requalification date is checked.
- LP-gas is heavier than air and may settle in low places while dissipating.
- Contact with the liquid contents of cylinder will cause freeze burns to the skin.
- Do not allow children to tamper or play with cylinder.
- When not connected for use, keep cylinder valve turned off. Self contained appliances shall be limited to a cylinder of 30 lb capacity or less.
- Do not use, store or transport cylinder where it would be exposed to high temperatures. Relief valve may open allowing a large amount of flammable gas to escape.
- When transporting, keep cylinder secured in an upright position with cylinder valve turned off.

WHEN CONNECTING FOR USE:

- Use only in compliance with applicable codes.
- Read and follow manufacturer's instructions.
- Consult manufacturer's instructions concerning the cylinder connection provided with your appliance.
- Be sure regulator vent is not pointing up.
- Turn off all valves on the appliance.
- Do not check for gas leaks with a match or open flame. Apply soapy water at areas marked "X". Open cylinder valve. If bubble appears, close valve and have LP-gas service person make needed repairs. Also, check appliance valves and connections to make sure they do not leak before lighting appliance.
- Light appliance(s) following manufacturer's instructions.
- When appliance is not in use, keep the cylinder valve closed.

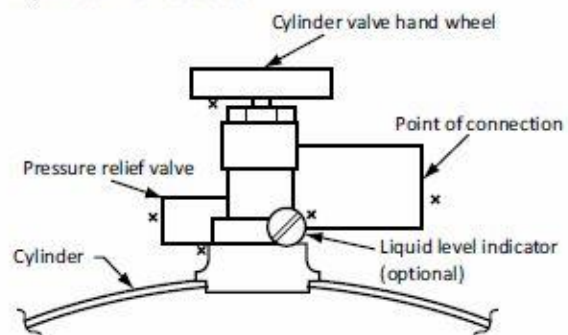

DO NOT REMOVE, DEFACE, OR OBLITERATE THIS LABEL
***EXCEPT AS AUTHORIZED BY ANSI/NFPA 58.**

⚠ DANGER. Do not store a spare LP cylinder under or near a barbecue grill, or other heat sources.
NEVER fill an LP cylinder beyond 80% full: a fire causing death or serious injury may occur.

Table of Contents

1 Important Safety Information	5
Technical Support.....	5
Symbol Legend	6
Important Safety Information for Installers.....	6
Important Safety Information for End-Users.....	7
2 Remote LP Tank System Enclosure Requirements - If Applicable	8
3 Villa Series Installation	12
4 Battery Requirements (Battery or DC Adaptor)	24
5 Lighting the Oven	25
6 First Firing	27
7 Troubleshooting	28
8 Wiring Diagram	29
9 Compatible Accessories	29
10 Replacement Parts	29
11 Warranty	30

Important Safety Information

- HPC Fire Inspired recommends that our products are installed by professionals locally licensed by the authority having jurisdiction in gas piping. All installation instructions must be followed to ensure proper performance and safety. HPC Fire Inspired assumes no responsibility for problems relating to the installation.
- To qualify for a warranty, all instructions must be strictly followed. Otherwise, the warranty may be void. Never alter product or configuration in any way.
- Annual servicing should be handled by professionals certified in the US by the National Fireplace Institute (NFI) as NFI Gas Specialists or in Canada by WETT (Wood Energy Technical Training).
- It is the installer's responsibility to ensure a safe installation and to educate the end-user regarding the features, safety recommendations and proper operation of this product.
- Please reference page 1 for all warnings.

INSTALLER:

Leave this manual with the appliance.

END USER:

Retain this manual for future reference.

Technical Support

For information and support contact your Hearth Products Controls dealer.

Important Safety Information

Symbol Legend



This is a Safety Alert Symbol

When you see this symbol on the fire pit insert, or in this manual, look for one of the following signal word panels alerting you to the potential for personal injury, death, or major property damage.

Please reference page 1 for all warnings.

Important Safety Information for Installers

Leave this manual with the end-user and instruct them to retain it for future reference. Instructions and product updates are also available at www.hpcfire.com under the Support tab.

Installers must carefully follow the instructions in this manual to prevent personal injury or property loss. These instructions contain information critical to the safe installation and operation of the fire pit.

- Instructions are updated as needed. It is the responsibility of the installers to check for product updates and installation manual updates at www.hpcfire.com prior to installation.
- It is the responsibility of the installer to follow:

Electrical

- The National Electrical Code, ANSI/NFPA 70. In Canada, Canadian Electrical Code CSA22.1
- Local codes
- Electrical should be checked prior to use and installation:
 - One 120VAC – 2.5-amp outlet

Gas

- Only use the gas/fuel type specified for this oven. Never use an alternative fuel to include biofuel, ethanol, lighter fluid, or any other fuel.
- The National Fuel Gas Code, ANSI Z223.1/NFPA 54 or International Fuel Gas Code.
- Natural Gas and Propane Installation Code CSA B149.1 or CSA B149.2.
- Local codes
- Gas pressure and type should be checked prior to use and installation.
 - **Natural Gas Fire Pit:** Supply Pressure: Minimum: 6.0 inches W.C.; Maximum: 7.0 inches W.C.
 - **LP Gas:** Supply Pressure: Minimum: 8.0 inches W.C.; Maximum: 11.0 inches W.C.

Important Safety Information

IMPORTANT

If pressure is low, this will reduce flame height on HIGH setting, resulting in little to no flame variation.



WARNING

- **DO NOT** move oven while it is operating or hot.
- **Keep outdoor cooking gas appliance area clear and free of combustible materials, gasoline or other flammable vapors or liquids.**
- **The oven is not to be installed in or on a recreational vehicle and/or boat.**
- **The oven is not to be installed inside of a living space (unless a ventilation exhaust system has been approved by the local building authority.)**



WARNING

- **DO NOT** lean on oven.
- **NEVER** use lighter fluid in the oven.
- **Oven is hot when in use; to avoid burns, DO NOT touch hot oven parts or surfaces. Keep children and pets away from hot oven.**
- **NEVER** leave the oven unattended while it is in use.
- **It is your responsibility to assemble and store, operate, and care for your gas oven properly.**
- **Do not vent propane vapors from the cylinder before taking it to be refilled.**
- **Do not use oven indoors or store any propane cylinder indoors, including in the garage, breezeways, sheds, or enclosed areas.**
- **Under some circumstances, propane may lose the distinctive odor that was added. Keep the service valve closed and plugged or capped (as recommended by the manufacturer) when the cylinder is not connected to the appliance including “empty” cylinders, Other strong odors may hide or mask the odor of propane. Colds, allergies, sinus congestion and the use of tobacco, alcohol or drugs may impair your ability to detect the odor of propane.**

Remote LP Tank System Enclosure Requirements - If Applicable

IMPORTANT

Locate the hose out of pathways to avoid accidental damage and prevent it from becoming a trip hazard.

For an enclosure using an LP tank system, follow these recommended specifications:

- You must follow local codes.
- One side of the enclosure shall be completely open: OR
- For an enclosure having four sides, a top, and a bottom:
 - At least two ventilation openings shall be provided in the side walls of the enclosure, located within 5 inches (127mm) of the top of the enclosure, equally sized, spaced at a minimum of 180 degrees, and unobstructed. The opening(s) shall have a total free area of not less than 1 in² lb. (14.2 cm²kg) of stored fuel capacity. See Figure 6.1.
 - Ventilation opening(s) shall be provided at the floor level of the enclosure and shall have a total free area of not less than 1/2 in² lb. (7.1 cm²kg) of stored fuel capacity. If ventilation openings at floor level are in a side wall, there shall be at least two openings. The bottom of the openings shall be 1 inch (25.4mm) or less from the floor level and the upper edge no more than 5 inches (127mm) above the floor level.
 - The openings shall be equally sized, spaced at a minimum of 180 degrees and unobstructed. See Figure 6 1.
- Every opening shall have minimum dimensions to permit the entrance of an 1/8-inch (3.2mm) diameter rod.

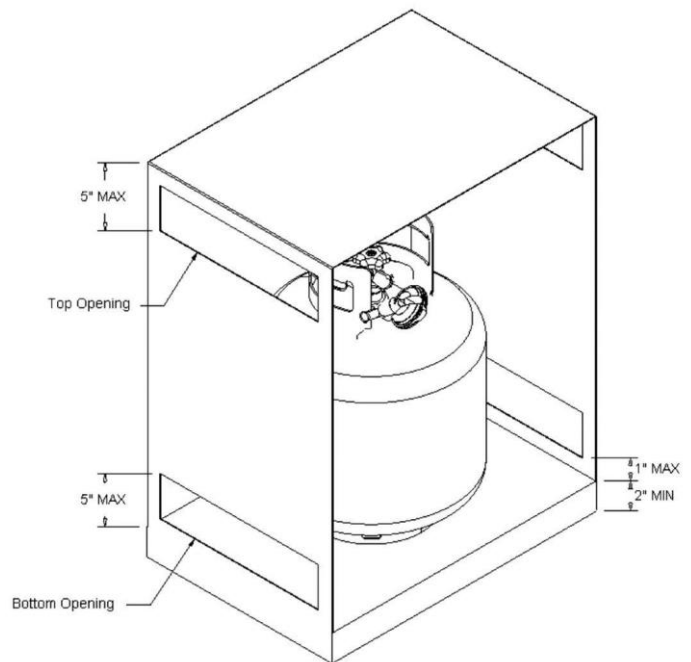

Figure 6.1 – Top and bottom side ventilation openings for LP tank enclosure.

Remote LP Tank System Enclosure Requirements - If Applicable

Ventilation openings in sidewalls shall not communicate directly with other enclosures of the appliance. See Tables 6.1 and 6.2.

LP Tank Size	Top Opening	Bottom Opening
20 LB (9.1 KG)	20 in ² (130 cm ²)	10 in ² (65 cm ²)
30 LB (13.6 KG)	30 in ² (195 cm ²)	15 in ² (100 cm ²)

Table 6.1 – LP tank enclosure opening specifications by tank size.

LP Tank Enclosure Specifications
2 Openings for each top and bottom - 180° apart
From LP tank base to bottom of opening - Max. 1" (25.4mm)
From floor to base of LP tank - Min. 2" (50.8mm)

Table 6.2 – LP tank enclosure opening specifications.

- The cylinder valve shall be readily accessible for hand operation. A door on the enclosure to gain access to the cylinder valves is acceptable, provided it is non-locking and can be opened without the use of tools. Designs using a cover to gain access to the cylinder and cylinder valve shall be provided with handles or the equivalent at a minimum of 180 degrees apart to facilitate lifting of the cover.
- The enclosure for the LP-gas cylinder shall isolate the cylinder from the burner compartment to provide:
 - Shielding from radiation.
 - A flame barrier; and
 - Protection from foreign material.
- There shall be a minimum clearance of 2 inches (50.8mm) between the floor of the non-disposable LP-gas cylinder enclosure and the ground.
- The design of the enclosure shall be such that:
 - A non-disposable LP-gas cylinder can be connected, disconnected, and the connections inspected and tested outside the cylinder enclosure; and Those connections, which could be disturbed when installing the cylinder in the enclosure, can be leak-tested inside the enclosure.

Remote LP Tank System Enclosure Requirements - If Applicable

Propane Cylinder: Safety Requirements

- This appliance has been designed for use with a 20-lb. or 30-lb. size propane cylinder (not supplied).
- The propane cylinder should be checked by your propane supplier prior to installation and use.
- Never use a cylinder with a damaged valve. A worn cylinder may be hazardous and should be checked by your propane supplier.
- Use only a propane supply cylinder constructed and marked in accordance with the specifications for LP gas cylinders by the National Standard of Canada, CAN/CSA B339, Cylinders, Spheres and Tubes for Transportation of Dangerous Goods; and Commission, as applicable or the Specifications for LP-Gas Cylinders of by the U.S. Department of Transportation (DOT).
- Do not store a spare LP-gas cylinder under or near this appliance.
- Never fill the cylinder beyond 80 percent full.
- Only use the pressure regulator and hose assembly provided with this appliance or replacement pressure regulators and hose assemblies as specified by the manufacturer. The regulator supplies a pressure of 11 inches water column to the appliance and has a QCC1 type fitting.

Propane cylinder specifications

- The propane cylinder must be provided with a cylinder connection device compatible with the connection for outdoor appliances.
- The propane cylinder must be supplied with a shut-off valve terminating in a propane cylinder valve type QCC1 and include a collar to protect the cylinder valve. A QCC1 cylinder has a positive seating connection, which will not allow gas to flow until a positive seal has been achieved. It is also equipped with an excess flow device. To attain full flow to the appliance, the valve must be in the off position when the cylinder valve is turned on.
- The propane cylinder must have a safety relief device having direct communication with the vapor space of the cylinder.
- The cylinder supply system must be arranged for vapor withdrawal.
- The cylinder shall incorporate listed overfill protection device (OPD).

Remote LP Tank System Enclosure Requirements - If Applicable

Securing the LP tank:

1. Fasten the L-bracket to the bottom of the propane tank using the nut and bolt (supplied). Ensure the nut is tight and will not loosen.
2. Select the location for the propane tank following the guidelines above, Figure 6.2.
3. Screw the bracket to the mounting surface. For concrete surface, use a concrete anchor (not supplied). Ensure that screw is tight so that the cylinder cannot move.

Connecting the Cylinder:

1. Ensure the gas regulator has no kinks and is smooth.
2. Remove the cap or plug from the cylinder fuel valve.
3. Insert the black QCC1 regulator nipple onto the QCC1 fuel valve and tighten until snug. Do not use tools.
4. Perform a leak test on all joints prior to using the gas appliance. A leak test must be performed annually and each time a cylinder is hooked up or if a part of the gas system is replaced.
5. Follow the instructions for natural gas hook-up if the appliance is to be connected directly to a house propane gas supply line.



WARNING

Failure to follow location and mounting guidelines for the LP tank could result in severe injury.



WARNING

- Locate the LP Tank and enclosure out of pathways to avoid accidental damage and prevent them from becoming a trip hazard.
- Locate the hose out of pathways to avoid accidental damage and prevent it from becoming a trip hazard.



WARNING

- Always ensure L-bracket is securely fastened to prevent the LP tank from tipping.

INSTALLATION

We suggest that our products be installed by professionals that are locally licensed by the authority having jurisdiction in gas piping.

Villa Series Installation

Install the Villa Series only in a solid surface counter that can withstand hot temperatures, like granite, concrete, or ceramic tile.

Adequate clearance must be provided for air openings into the combustion chamber, for servicing, and proper operation of the bottom half of the oven should stay open. This will allow for proper combustion of air into the burner housing. Not having proper combustion of air will cause improper operation and may cause damage to the burner system.

1. Always maintain a minimal clearance of 24 inches or 60 cm from front and sides of oven to any combustible construction.
 2. Minimum clearance of most superior part of oven opening to any combustible material immediately above the oven's opening; including attached roof overhang/soffit connected to a building is 36 inches. Do not obstruct the flow of combustion and ventilation air.
 3. Keep the ventilation opening(s) of the gas cylinder enclosure and cabinet under hearth free and clear from debris.
 4. The oven burns solid fuel and exhausts through the front opening. Smoke and carbon monoxide decipation should be taken into consideration whenever designing a permanent location for the oven under a covered structure, a liscenced professional should be able to determine if the installation of an exhaust hood is necessary and determine if your installation location supports these types of equipment. Please consult a local HVAC liscenced professional for further assistance. This is to prevent any smoke inhalation and carbon monoxide dangers, to estheitcally minimize the discoloration of surrounding structures, and to assure permits and inspections comply with local authorities.
- ✓ Keep combustible materials 24 inches from side of oven's hearth.
 - ✓ Oven cannot be set on top of counter (its design needs to have air flow throughout the entire bottom)
 - ✓ To prolong the life of your oven, use an outdoor cover whenever oven is not in use. It will protect oven from UV rays, rain, and snow.

Cut-out Diagram for Countertop

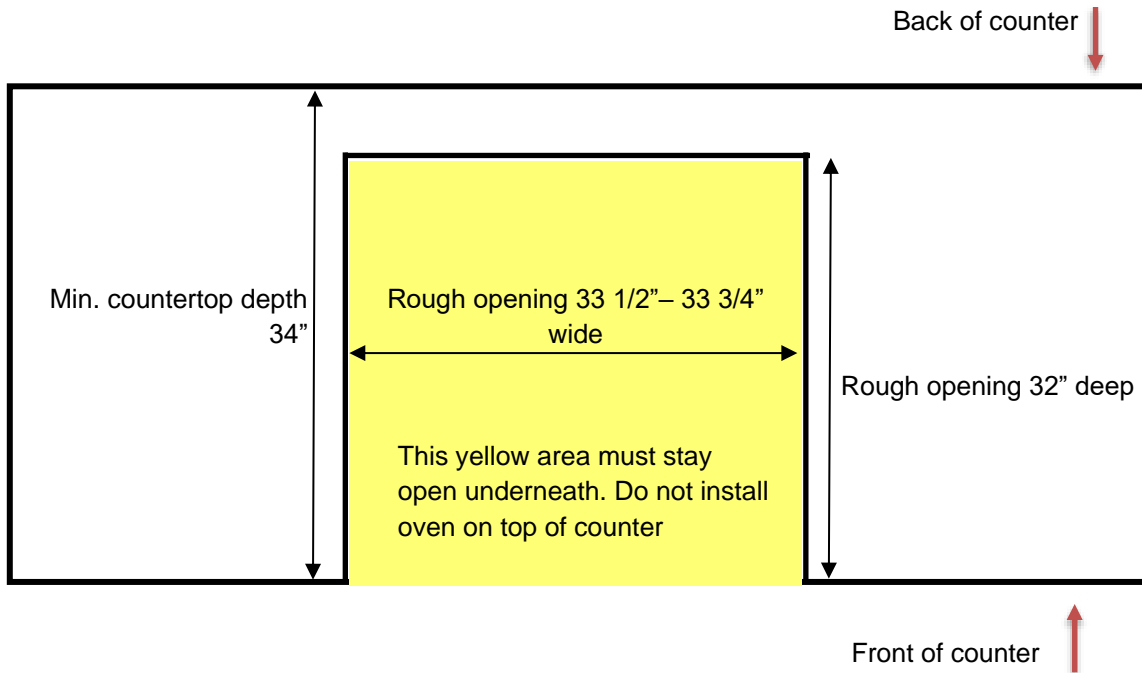

*Minimum opening width must be 33 1/2 inches

*Maximum opening width must be 33 3/4 inches

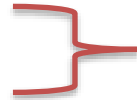

For flange rough opening cutout

*Support is needed on each side of the counter 1 1/2 inches from rough opening (locking tabs from phalange need to go underneath the counter)

* Oven cannot be set on top of counter (its design needs to have air flow throughout the entire bottom)

Preparation



Stainless Steel Flange



Hearth



Oven

Before beginning installation or operation of the product, please make sure all the parts are present. If any part is damaged or missing, do not attempt to assemble, install, or operate this product.

- Please have a licensed hearth installer perform the installation.
- Always have two to three people to install the oven.
- The Villa Series installed weighs approx. 400lbs. Please make sure the counter cutout has support on each side where the oven will be installed, otherwise the weight from the oven and heat might break the counter. (Please follow weight requirement from the cut-out diagram)

IMPORTANT

Do not install oven on top of countertop.



Scan this QR code to access
Villa Series Install Video



Villa Series Installation

1- Remove flange's protective plastic from flange



2- Place Flange in desired location and mark for



3- cut countertop



4- Safely remove countertop cutout



5- Place flange into opening. Edge of flange flush with countertop edge

Villa Series Installation



6- Locate holes of flange and insert locking tabs underneath and tighten screws to secure flange in place



If front support is covering front hole use (Tapcon) concrete screw to fasten flange



7- Two people place hearth onto flange

Villa Series Installation



8- Tighten 3 thumb screws to bottom of



9- Tighten gas line to bottom of hearth

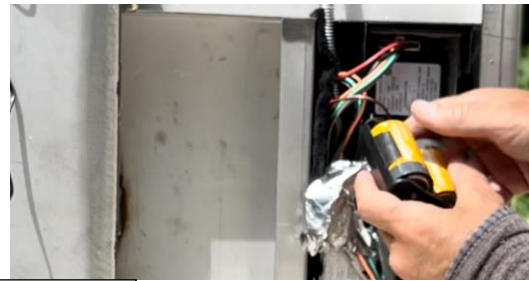

9- Either connect 3v adapter to module or use batteries.

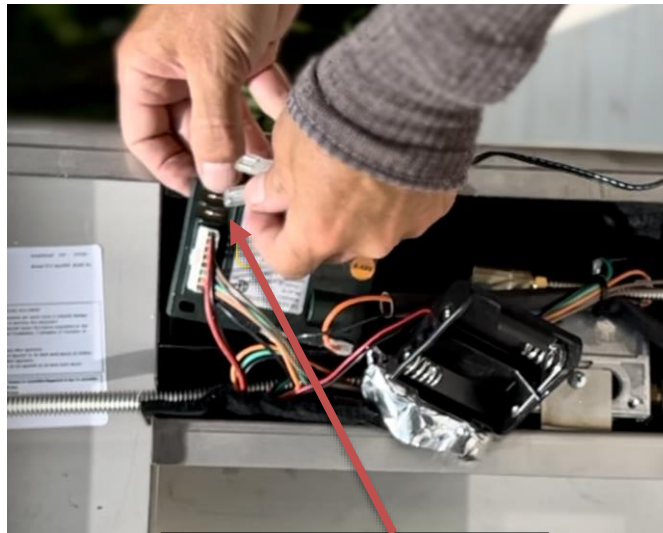

10- Adapter connects here

Villa Series Installation



11- Check for gas leak and connect 3v adapter to 110v

12- Place oven on 36x36 inch 3/4 thick board and transport



13- Place board on top of burner and slide to back of oven



14- Hold board and slide oven to

15- Lift front of oven and remove board



Villa Series Installation



16- Position oven in desired location



17- Install vent



Your oven is ready!

How to assemble the Villa Series on concrete countertop

For concrete counters with more than 1" thickness a slit must be made on concrete counter to accommodate for fastening brackets.

- A- place flange in opening
- B- then mark with pencil location for slits
- C- then with a concrete diamond blade make the slits on the concrete counter deep enough so bracket can safely hold flange in concrete countertop
- D- tighten screws



Front elevation of cabinet

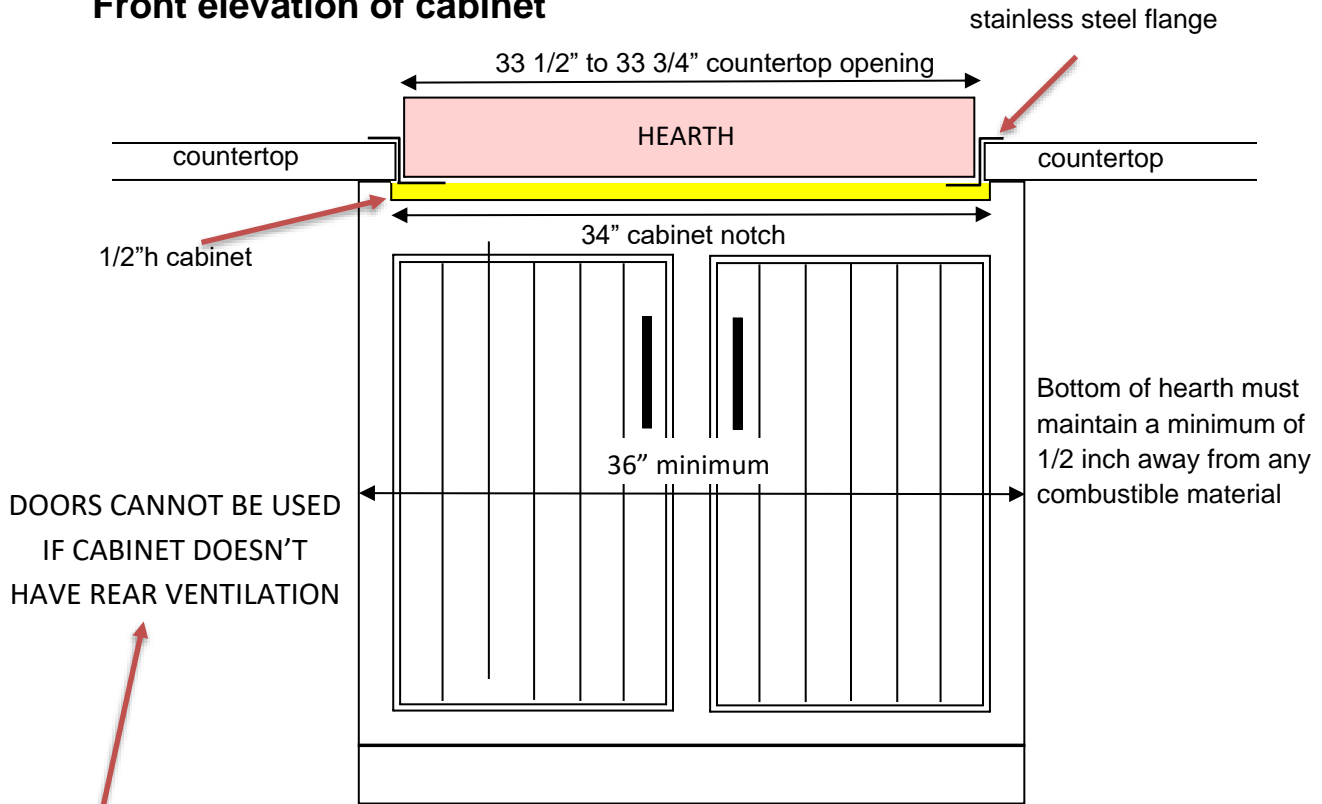

Rear elevation of cabinet

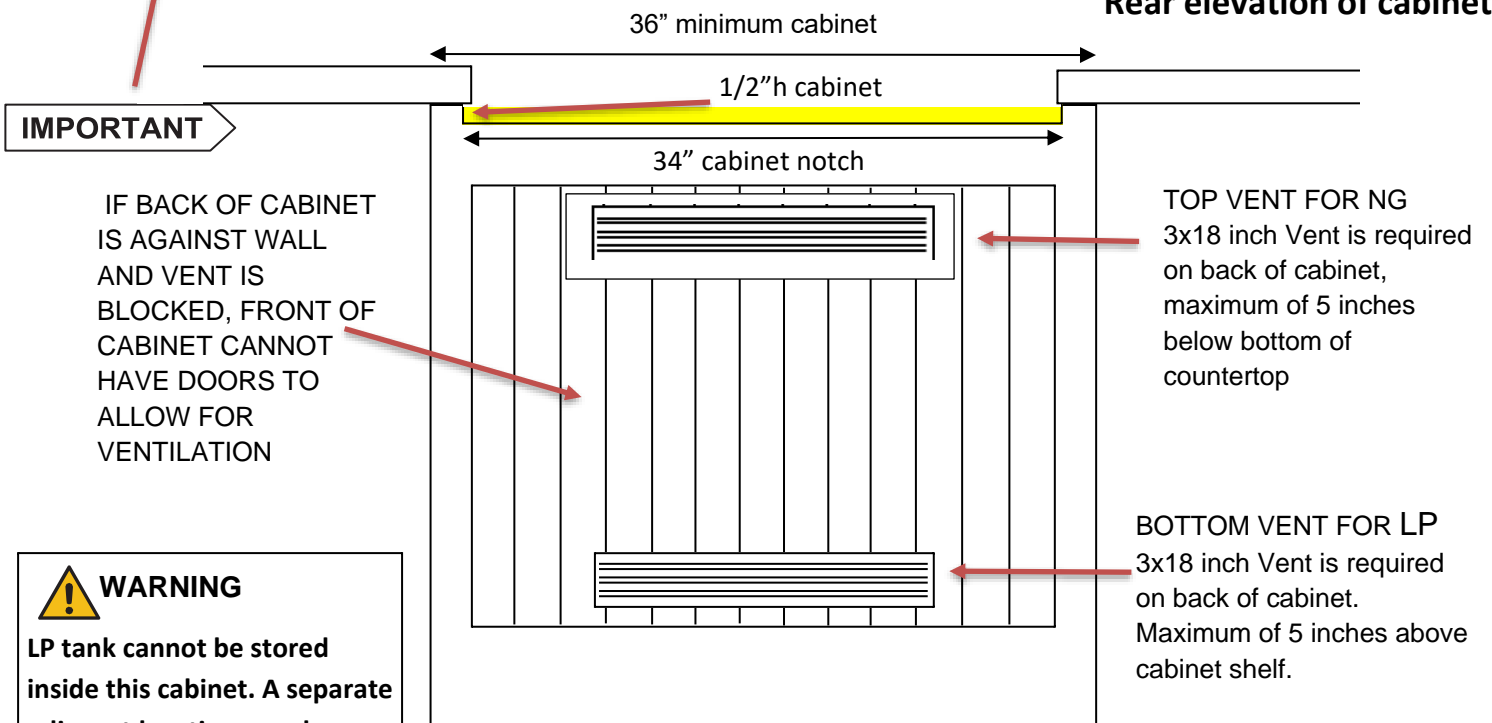

IMPORTANT

WARNING
 LP tank cannot be stored inside this cabinet. A separate adjacent location may be used.

Top view

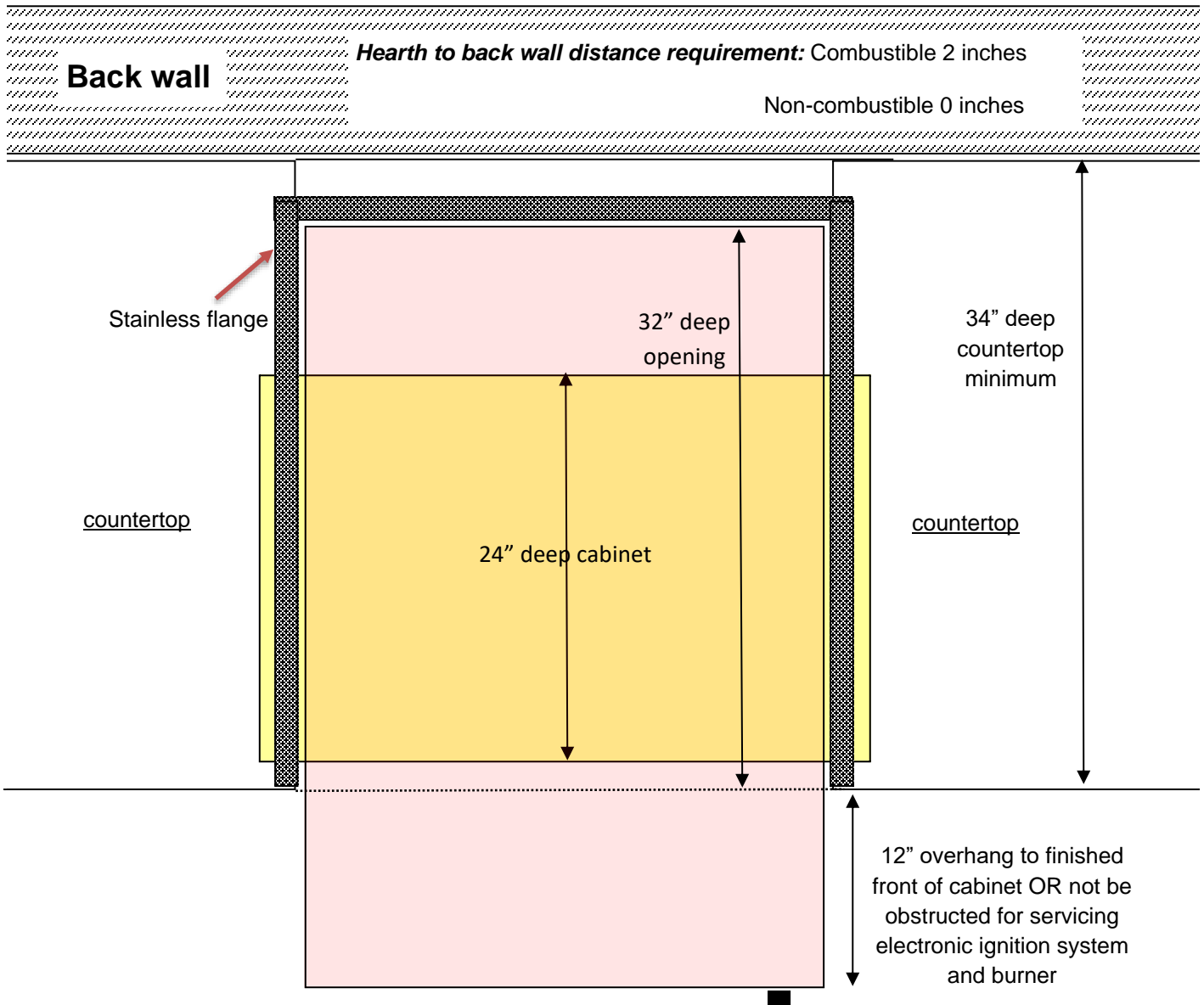

IMPORTANT

OVEN HAS TO OVERHANG 12 INCHES FROM FINISHED FRONT

Villa Series Installation

Vent and door install

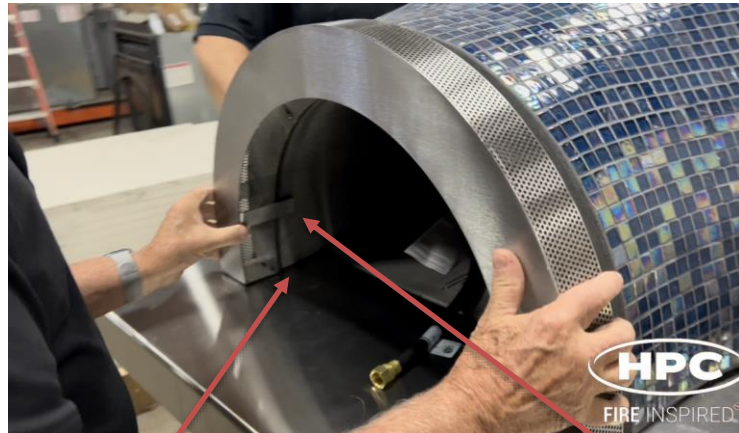

Insert vent in front of oven opening by lifting front of oven and inserting vent tabs under and around the inside of door opening.

- Make sure burner is off

The Oven Vent enables you to use the door and burn wood and use gas while door closes the opening, like your oven at home. You may control the heat by regulating the flame on the gas burner.

- Do not touch Oven Vent. It is hot and may cause burn.
- Use wooden door handle to remove door, door is also hot and may cause burn.



WARNING

- Vent must be installed prior to operating the oven. If oven is used without vent, it can cause dangerous and unsafe conditions to the user
- Door cannot be used with gas unless oven vent is in place or gas is off

Battery Requirements (Battery or DC Adaptor)

NOTE: This appliance is equipped with a low voltage electronic ignition system. The electronic ignition requires 3 Volts DC. It can either be supplied by a 110v to 3v transformer adaptor or 2 D cell batteries (in case electrical supply cannot be supplied).

Battery powered use 2 D cell batteries:

Please follow the built-in instruction requirement picture for the location of 110v 15-amp GFCI outlet. (Outlet should be located on left side of oven base minimum 12 -18 inches from oven's hearth). You must follow all National Electrical Code regulations. In addition, be aware of local codes and ordinances when installing your service.



IMPORTANT Do not ground to a gas pipe.

IMPORTANT Keep the power supply cord and fuel hose away from hot surfaces.

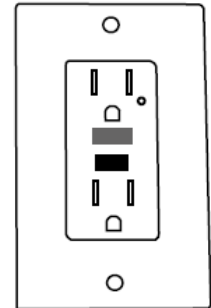

Upon installation of electrical outlet and oven installation, plug in outlet 3volt transformer and proceed with installation.

Lighting the Oven

This oven is equipped with an electronic ignition system. This system can operate with 2 D batteries, or it can be used with a 3-volt DC adaptor. The batteries should last between 6 months to 1 year depending on use and where the oven is placed (extreme heat and cold temperatures will decrease the life of the batteries). Please check battery frequently to make sure its appearance is normal. We recommend battery replacement every 1 year from time of purchase. Forno de Pizza by HPC also has an adaptor that can be used to electronically ignite the pilot and operate the oven gas burner. This adaptor must be plugged into a 110v GFCI outlet.

The oven's gas burner will not operate unless the safety pilot is on (oven cannot be lit with a lighter flame)

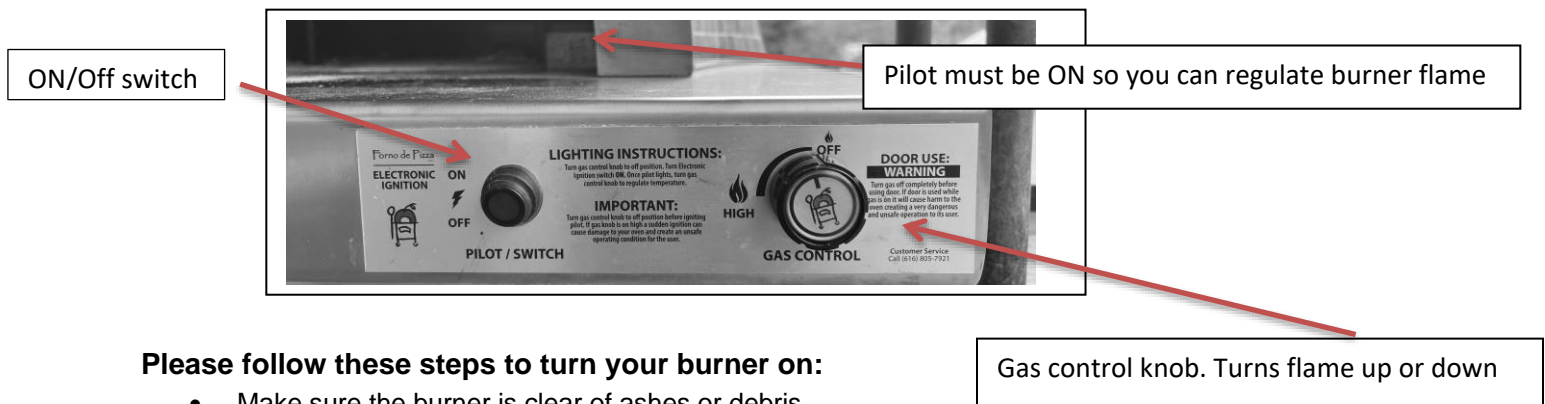

Please follow these steps to turn your burner on:

- Make sure the burner is clear of ashes or debris.
- Make sure valve control valve is on off position.
- Turn on valve on LP cylinder or natural gas shut off valve.
- Turn valve in the oven control panel to off position.
- Turn the electronic igniter switch ON. It might take 30 to 60 seconds for gas to travel from tank to pilot the first time you start your oven)
- Once pilot is lit, turn the gas control knob from OFF position slowly to regulate burner flame.
- Turn gas regulator knob to OFF and place small pieces of dried hardwood on burner. Regulate gas flame so wood can ignite. Leave gas on.
- Once wood has ignited and smaller pieces of coal have formed, with the back of brush push wood to center of oven to heat the hearth. Then place more wood on top of the coals.
- Leave the gas line ON. It will do a couple of things.
 1. Keep the oven hot and the flame steady.
 2. Keep the smoke to a minimum.

(If you have too much smoke because the fire is dying, wood is wet or not enough wood – try turning the gas up a bit, it usually burns off the smoke.)

- Your oven should be hot enough to bake a pizza in about 30 min. (obviously cooler temperatures take a bit longer) the use of our insulating blanket should also help with heat retention.)
- Distinct locations in the oven heat up differently – The hearth at its hottest temperature gets around 800°. Inside the dome on top-over 1000°. The outside of dome on left side (where the burner is lit) can reach about 400°
- A clever way to test the hearth to see if it is hot enough to bake a pizza – throw some flour on the hearth and it should burn within 1-2 seconds. If not, then with brush bring the wood back to center of oven, add more wood and let it burn hotter. Then move it to the back of the oven.
- Brush center of the hearth

Lighting the Oven

- Place pizza on hearth and turn pizza ¼ turn every 30 seconds or watch for golden brown on cheese and dough.
- Remove pizza and enjoy.

To Use as a Grill

- Follow the same steps to start oven and hearth.
- Place disposable aluminum pan on the hearth to catch grease.
- Insert grill rack with a hot pad/mittens.
- Add grill rack to oven (It is a clever idea to spread some olive oil on the grill rack top before putting it in the oven.)
- Add food – Watch it sizzle.
- Remove. Enjoy.
- If your food does not need a grease pan, you can leave amber on hearth and slide grill rack on top of it.
- You may grill, bake, or use a skillet on top of the rack. The possibilities are endless.
- We suggest the use of an infrared thermometer if you want to do more detailed temperature control like breads and chicken.
- We suggest baking bread in the front of the oven where the temperature is around 300-400°.
- We suggest smoking after cooking is complete. Close the door and let the fire die out. Adding some of your favorite smoking wood chips to the “died-out fire” will create smoke in the oven and it will remain circulating inside the oven. Smoking should be done at lower temperatures. Oven door temperature gauge should be pretty accurate in displaying oven temperature.
- Heat control can be achieved by decreasing the amount of wood, decreasing gas, closing the door (Door works as a damper-less oxygen entering oven, less fire).



CAUTION

Never place door without door vent whenever gas is turned on. It might cause an explosion. If smoking, remove door vent turn gas completely “off” at gas control knob and at the LP tank/shut off valve.

- Whenever you are done using the oven, make sure LP tank is off and let oven cool down.
- Do not place outdoor cover on till oven has cooled down.
- Careful! Door will be hot. Only touch the wooden handle.
- The oven will create soot(creosote) and the use of properly seasoned (6-12 months dried) wood (oak) that has no bark nor any contaminants (oil, paint, dirt) will help minimize the smoke and soot buildup.
- Do not use wood that generates sparks and pops in the oven, it may create fire hazard outside of the oven, and give food undesirable taste.

First Firing

Forno de Pizza by HPC Fire ovens are constructed for optimum performance. It is important to heat the oven gradually in first firing.

IMPORTANT

Follow oven curing instructions to properly cure the oven.

Do not heat up the oven too quickly. It will damage the tile.



About your refractory oven:

A refractory material is one that retains its strength at hot temperatures. Your oven's refractory material can withstand temperatures up to 2400 degrees.

Unlike other ovens in the industry that are multi-pieced and joined together with mortar, your oven is shaped as one piece allowing it to be moved maintaining its shape and aesthetics of a century's old oven.

This shape enables the best functional heat distribution in the oven. Its two-inch wall thickness reflects enough heat back to the inside of the oven, and the temperature on the outside of the oven remains one third of the inside temperature, optimizing heat retention.

3 heat sources and temperatures that exceed 1000°

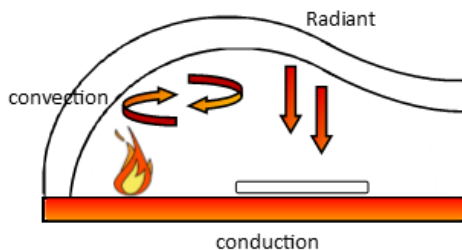

Please scan this QR code for video:

HOW TO CURE YOUR OVEN -1ST FIRING



Your oven's first firing:

First time firing- heat up with gas only.

1. Start with a 1/2 inch extremely low flame on the gas burner for 2 hours.
2. Raise flame to 1 1/2 inch in size for 1 hour.
3. Increase flame to 2 1/2 for 1 hour
4. Stoke with kindling on the burner to continue to raise oven's temperature for another 1 hour
5. Do not use door during first firing
6. Complete at least 5 hours for the first firing

Essential information:

Once your oven is poured and removed from its mold, it goes through a drying process that allows water to evaporate. Glass is mortared using a proprietary formula that will withstand the high heat generated during normal operation. To properly cure the glass to the oven a heat up schedule should be properly performed. During your first oven firing, small water molecules that remained trapped in the refractory during the drying process will come out in a vapor form.

WOOD-OAK-ONLY!

Simple and important for proper operation.

-Use at least 1 year dried, debarked 1 1/2-to-3-inch diameter, 12- to 14-inch-long OAK. You will have consistency during operation, no smoke, no popping ambers on to your food, intense heat, and a great smell.

Troubleshooting

Table 11.1 below indicates some potential causes and countermeasures to the symptoms indicated in bold type. **Please contact your retailer or certified technician for service and repair.**

Service



We suggest that our products be serviced by a professional certified in the US by the National Fireplace Institute (NFI) as NFI Gas Specialists.

Problem	Possible Causes	Solution
Gas burner does not light up	No spark	Replace your battery, make sure you have power to the oven if using adaptor Check pilot for spider webs or ashes and clear it from the pilot burner
	No gas	Make sure gas valve is open
		Make sure tank has propane and for natural gas make sure shut off valve is ON
		Tank might be empty
Pilot does NOT stay lit	Insufficient gas (Most common in Natural gas hook-up)	- (check recommended gas tubing sizes/run) if you do not have sufficient natural gas pilot will not ignite. If there is more than one appliance using gas at a time, pressure to oven might be diminished
	Debris in pilot	Ashes or spider webs can obstruct pilot not allowing it to fire- blow with a compressed air keyboard duster
	Faulty pilot sensor	Could be faulty sensor, loose sensor wire from pilot or faulty module sensor- test and replace pilot, or replace module
Too much smoke coming out of oven	Wood is wet	-Make sure wood is dry and free of paint, oils, sap, varnishes
	Fire is not hot enough	Turn gas valve to high till smoke diminishes
	Oven door opening is not allowing air in to vent, thus killing fire	Make sure door opening allows enough air to burn fire (remove door)
Pizza dough not cooking fast enough	Hearth is not hot enough	-use infrared thermometer to check hearth temperature should be 625 to 650 degrees
	Oven temperature is low	Add wood or turn gas higher
Pizza is burning	Oven too hot	-let oven cool down
		Turn pizza more often
Pizza is not cooking on top	Pizza has too many ingredients	-Put pizza on aluminum paddle And raise it to the top of oven (it is hotter on top of the oven)
	Fire is not hot enough	Turn gas up

Wiring Diagram

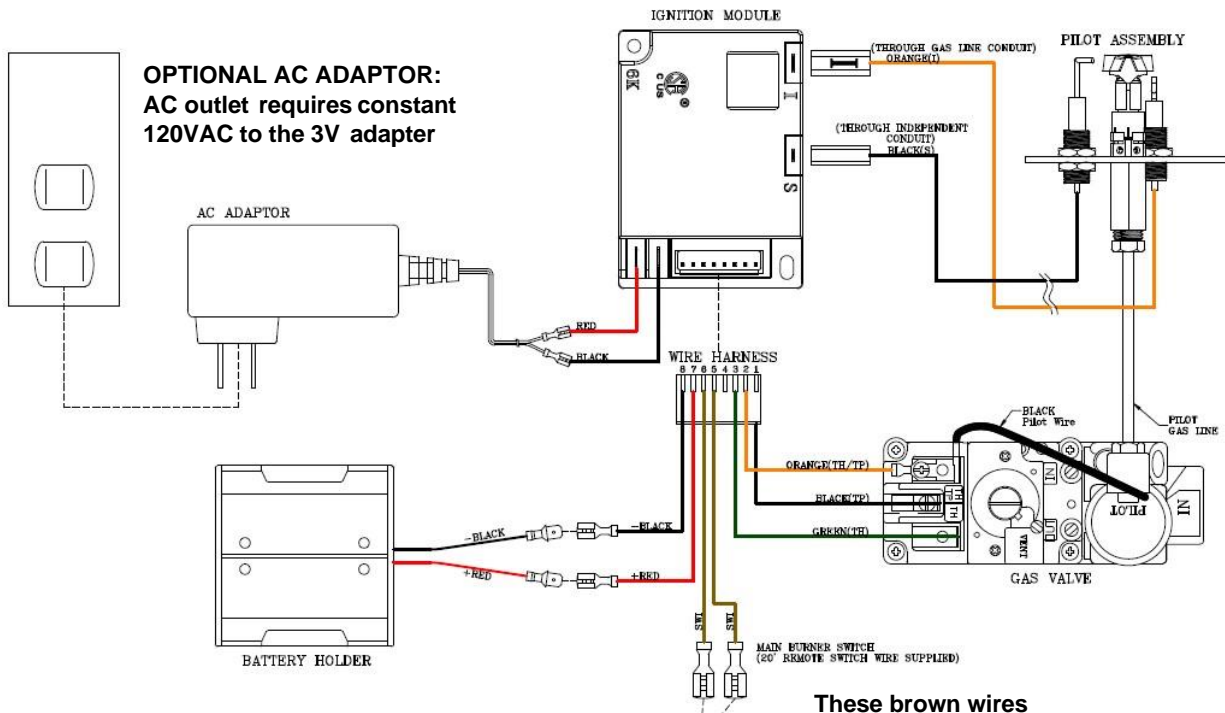

These brown wires control the ON/OFF switch that operates the Oven.

Compatible Accessories

For a complete list of accessories, visit www.hpcfire.com



Link QR code to accessories page

Replacement Parts

Please contact your dealer for parts – if unsure please contact HPC Fire Inspired or visit our website at www.hpcfire.com and we will be happy to help you.

Warranty

HPC Fire Inspired warrants that for a period of two years from the original purchase, this product will be free of defects in material and workmanship. HPC'S Forno de Pizza Oven, at its option, will repair or replace this product or component of the product found to be defective during the warranty period. Replacement will be made with new or remanufactured products or components. If this product is no longer available, replacement may be made with a similar product of equal or greater value. This is your exclusive warranty.

This warranty is valid for the original retail purchaser from the date of the initial purchase and is not transferable. Keep the original sales receipt. Proof of purchase is required to obtain warranty performance. HPC Fire Inspired dealers, service centers, or retail stores selling HPC Fire Inspired do not have the right to alter, modify or in any way may change the terms and conditions of this warranty. This warranty does not cover normal wear on parts or damage resulting from any of the following: negligent use or misuse of the product, improper handling, use on improper voltage or current, and use contrary to the operating instructions, improper disassembly, repair, or alteration by anyone other than HPC Fire Inspired or an authorized service center. Further, the warranty does not cover the improper use of gas and subsequent explosion or poisoning due to gas exposure, Acts of God, such as fire, flood, hurricanes, and tornadoes. HPC Forno de Pizza Oven's two-year warranty only applies for the oven in residential use.

With extreme temperature fluctuation in oven cracks will form on the oven but should not affect its performance and or break the oven apart. These cracks are to be expected HPC Fire Inspired cannot warranty a crack free oven. Oven replacement is not included due to cracks. Improper heating or handling of the refractory material can affect the oven's integrity and HPC's Forno de Pizza oven is not responsible for cracks in the refractory material larger than one eighth of an inch. If cracks become larger than one eighth of an inch, please contact HPC Fire Inspired for repairing instructions or servicing. Please contact HPC Fire Inspired if you do not understand your warranty or the instructions on how to use the oven. HPC Fire Inspired shall not be liable for any incidental or consequential damage caused by the breach of any express or implied warranty or conditions. Some states, provinces or jurisdictions do not allow the exclusion or the limitation of incidental or consequential damages, so the above limitation or exclusion may not apply to you. Except to the extent prohibited by the applicable law, any implied warranty of merchantability or fitness for a particular purpose is limited in duration to the duration of the above warranty or conditions. Some states, provinces or jurisdictions do not allow limitations on how long an applied warranty lasts, so the above limitations may not apply to you. This warranty gives you specific legal rights, and you may also have other rights that vary from state to state or province to province.



FIRE INSPIRED™

Inspired by safety.
Innovated for your lifestyle.

Hearth Products Controls

2225 Lyons Road
Miamisburg, OH 45342

For detailed product information, go to
www.hpcfire.com