

**TUNGSTEN**  
SMART-HEAT™ ELECTRIC

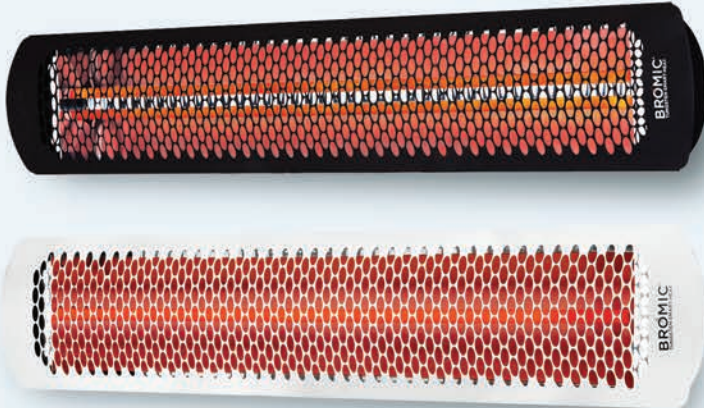

An infrared electric heater  
blending aesthetics and function

The Tungsten Smart-Heat™ Electric range brings high-performance radiant heating to open outdoor applications and semi-enclosed spaces alike. This heater's extended body and parabolic specular reflector (PSR) provides a wide wall of heat across a vast footprint, maximizing the comfort created by each unit. Available in 4 models with heat outputs of up to 6kW, these units emit minimal light and present a scalable solution for those wishing to tailor heating systems specifically to the space serviced.





# TUNGSTEN SMART-HEAT™ ELECTRIC

MODEL NUMBER	2000 SERIES	3000 SERIES	4000 SERIES	6000 SERIES
PRODUCT CODE	BH0420030	BH0420031	BH0420032 BH0420034 BH0420012	BH0420033 BH0420035 BH0420013
FUEL TYPE	ELECTRIC	ELECTRIC	ELECTRIC	ELECTRIC
COLOR	BLACK	BLACK	BLACK   WHITE	BLACK   WHITE
HEAT AREA	65FT <sup>2</sup>	100FT <sup>2</sup>	130FT <sup>2</sup>	160FT <sup>2</sup>
RATED CURRENT **	240V/8.3A 208V/9.62A 277V/7.22A	240V/12.5A 208V/14.42A 277V/10.83A	240V/16.6A 208V/19.23A 277V/14.44A	240V/25A 208V/28.85A 277V/21.66A
MINIMUM FLOOR CLEARANCE	WALL 72"   CEILING 96"		WALL 72"   CEILING 96"	

## MOUNTING OPTIONS

CEILING MOUNT	✓	✓	✓	✓
CEILING RECESS KIT PRODUCT CODES	BH8180010	BH8180011	BH8180010	BH8180011
WALL MOUNT	✓	✓	✓	✓
RECESSED   FLUSH MOUNT	✓	✓	✓	✓
CEILING POLE MOUNT	✓	✓	✓	✓
TUBE SUSPENSION KIT (36") PRODUCT CODE	BH8180012			
FREESTANDING	-	-	-	-

## CONTROL OPTIONS

ON   OFF	✓	✓	✓	✓
ON   OFF PRODUCT CODE	BH3130010-1			
DIMMER	✓	✓	✓	✓
DIMMER PRODUCT CODE	BH3130011-1			
MASTER REMOTE *	✓	✓	✓	✓
MASTER REMOTE PRODUCT CODE	BH3130012			

Measurements displayed within this catalog are minimum requirements for installation. Bromic takes no responsibility for incorrect or non-compliant installations. All measurements in this catalog are displayed in inches.

\*\* Available in varying voltages: 240V, 208V and 277V

\* Control up to six zones of heaters with unlimited heaters per zone from a single control. Works with dimming controllers. Control operates within 100ft of heaters.

## PRODUCT MEASUREMENTS

2000W & 4000W

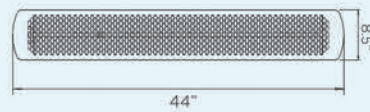

3000W & 6000W

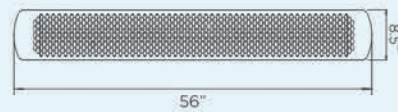

## CEILING RECESS

CEILING RECESS FRAME 2000W & 4000W

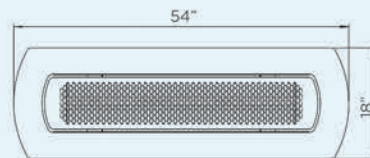

CEILING RECESS FRAME 3000W & 6000W

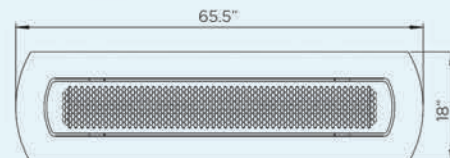

### CEILING RECESS

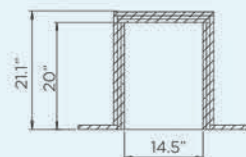

MINIMUM  
CEILING  
CAVITY

2000W & 4000W

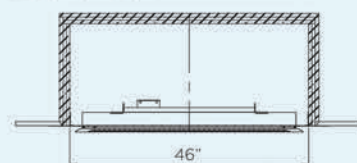

3000W & 6000W

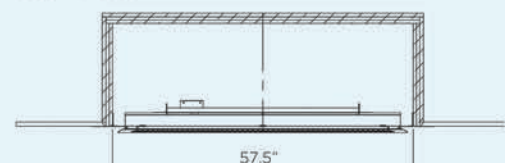

## CEILING & WALL MOUNT CLEARANCE

### CEILING MOUNT CLEARANCE

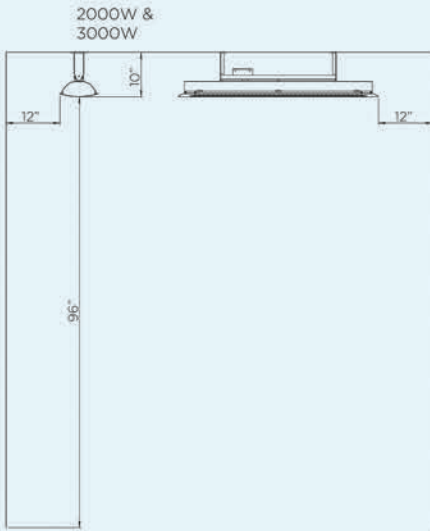

### CEILING MOUNT CLEARANCE

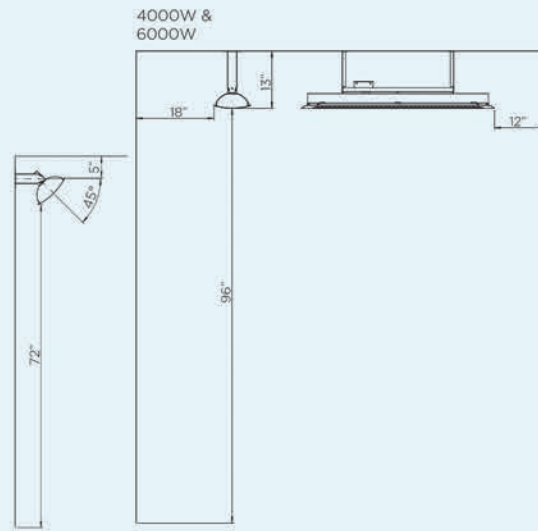

### CEILING POLE CLEARANCE

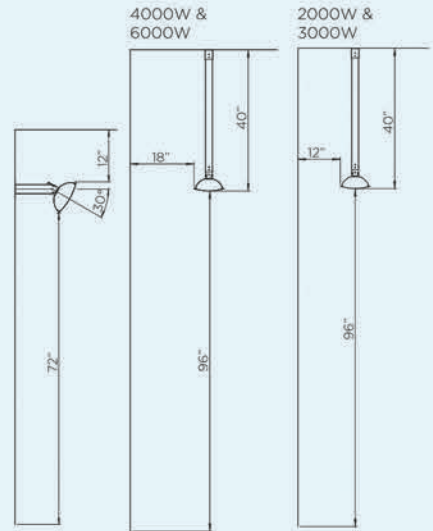

## WALL BRACKET (INCLUDED)

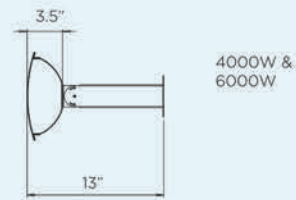
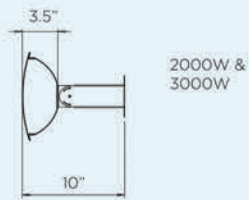

## HEAT AREA

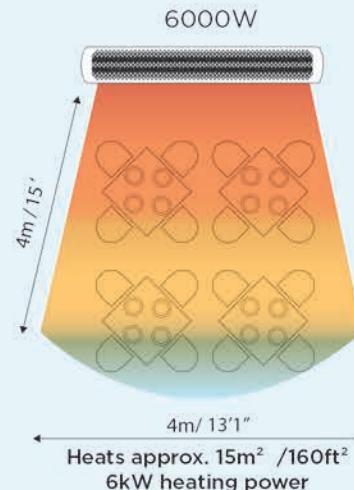
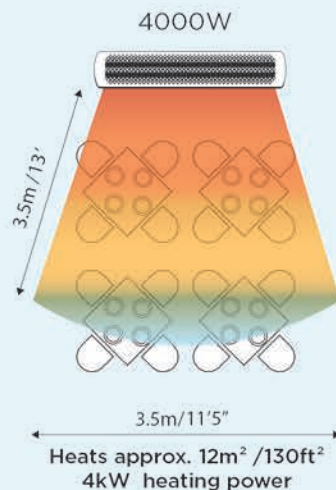
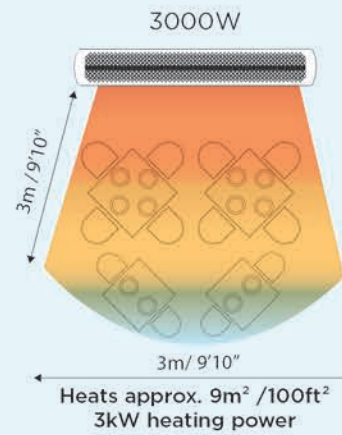
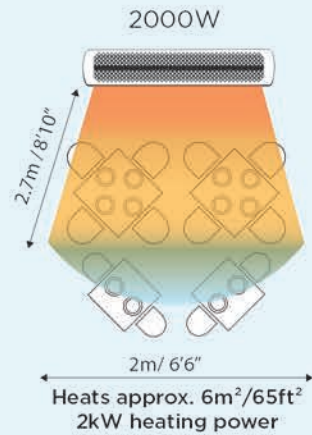

\*HEAT AREA DEPENDENT ON AMBIENT TEMPERATURE AND WIND. OPTIMUM CONDITIONS EXPERIENCED AT APPROX 60°F AND IN A LOW WIND COVERED ENVIRONMENT.



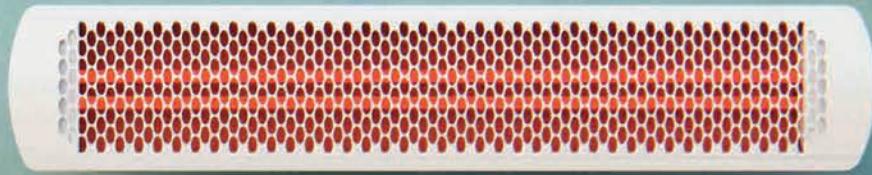

EXTEND YOUR COMFORT OUTDOORS  
WITH THE SUPERIOR HEAT AND  
STYLISH DESIGN OF OUR  
SMART-HEAT™ OUTDOOR HEATERS.

---

