

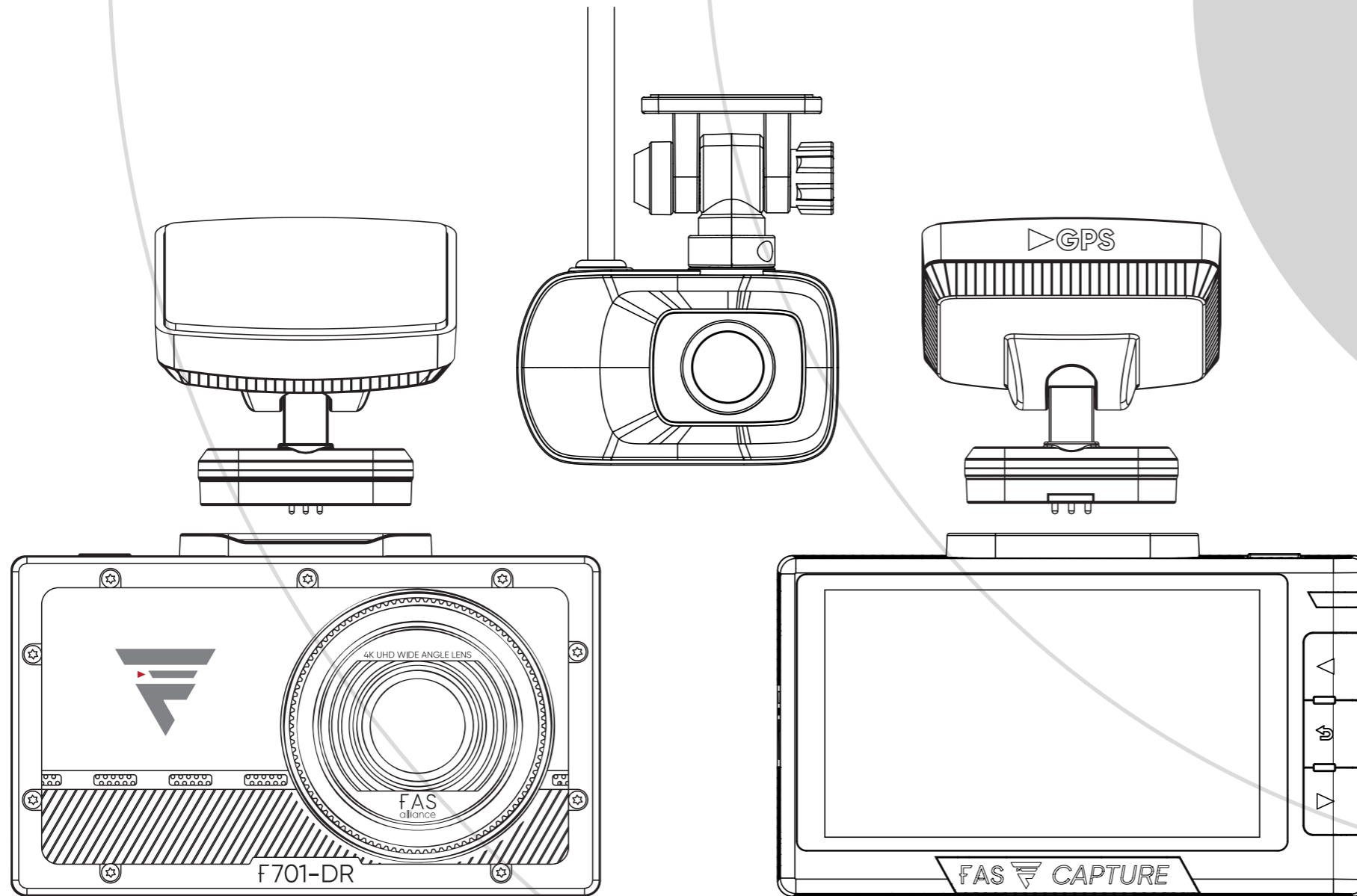

FAS-CAM

**F701
F201 (Optional)
User Manual**

English V22.05.12



www.fasalliance.com

Table of Contents

1: Introduction

2: Safety Information

3: Product Overview

3.1 Box Content

3.1.1 Standard Items

3.1.2 Accessories (Sold Separately / Coming Soon)

3.2 Part Name

3.2.1 Front Camera F701-DR Front View

3.2.2 Front Camera F701-DR Rear View and Dimension

3.2.3 Front Camera F701-DR Bottom View and Dimension

3.2.4 Front Camera F701-DR View Display Icon Names

3.2.5 Front Camera F701-DR Mount Bracket and Dimension

3.2.6 Rear Camera F201-IR (Optional) Front View and Dimension

4: Installation

4.1 Front Camera F701-DR Installation

4.1.1 Insert TF Card (SD Card)

4.1.2 Unit Test

4.1.3 Front Camera Pre-Alignment

4.1.4 Surface Preparation

4.1.5 Optional Electrostatic Film

4.1.6 Power Cord Wiring Placement - Cigarette Lighter

4.2 Rear Camera F201-IR Installation

4.2.1 Rear Camera Pre-alignment

4.2.2 Rear Camera Installation

4.2.3 Rear Camera Wiring Route and Placement

4.2.4 Rear Camera Wiring Route and Placement for SUVs

4.3 Power-on

4.3.1 Power-on

5: FAS-CAPTURE / FAS-MODE

5.1 FAS-CAPTURE

5.2 FAS-MODE

5.2.1 When to use

6: Operation

6.1 Recording

6.1.1 Power-on and Start Recording

6.2 Playback

6.2.1 Browse File

6.2.2 Delete File

6.2.3 Play and Pause File

6.2.4 Protect and Unprotect File

7: Settings

7.1 Function Settings

7.1.1 Presets

7.1.2 G-Sensor

7.1.3 Loop Recording

7.1.4 Screen Brightness

7.1.5 Indicator Light

7.1.6 Parking Mode

7.1.7 RearCam NightVision



Table of Contents

7.2 Video Settings

7.2.1 Exposure

7.2.2 Refresh Rate

7.2.3 Audio Recording

7.2.4 Stamp Display

7.2.5 Rotate Rear Cam

7.2.6 Exposure Rear Cam

7.3 System Settings

7.3.1 Date & Time

7.3.2 Language

7.3.3 Format TF Card (SD Card)

7.3.4 Speed Units

7.3.5 Screen Saver

7.3.6 Device Sound

7.3.7 System Info

7.3.8 Default Restore

8: Video Playback App

8.1 Request for Registration Code

8.2 Installing DVPlayer

8.3 Video Playback

8.4 Understanding Video Information

9: Cabin View

10: Firmware

10.1 Firmware Version and Product Registration

10.2 Firmware Update

11: Specification

11.1 Front Camera F701-DR

11.2 Rear Camera F201-IR (Optional)

12: Troubleshoot

13: Warranty and Product Support

13.1 Warranty

13.2 Product Support



[Video Tutorials QR Code]

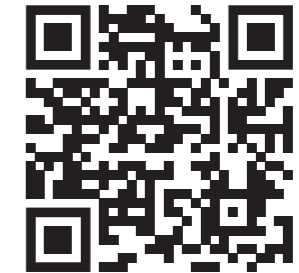

[Other User Manuals QR Code]



1 Introduction

Thank you for purchasing FAS-CAM Dash Mount Camera.

This User Manual introduces information on how to operate your FAS-CAM. Before using your FAS-CAM, we strongly recommend that you read through this User Manual to ensure proper operation and full machine performance. For product performance improvement purpose, the contents of this User Manual and product specifications may change without prior notice.

Note

We highly recommend using Lexar microSD cards with FAS-Alliance dash cams. Our dash cams have been tested specifically for use with Lexar branded SD cards. We recommend using at least a 64GB U3 card for the F701-DR series. If connecting to our rear cam, we advise using a 64GB U3 or 128GB U3 card for best results. The F701-DR series supports up to 256GB max microSD cards. For those looking to use FAS-CAPTURE, FAS-MODE, or Parking Mode frequently, we recommend using a microSD card larger than 32GB due to the size capacity. However, a 32GB card can be used for regular use. Other brands of microSD cards may cause the processor to overheat and are not recommended. Please note that using an unrecommended brand may cause your warranty to be voided.

Lexar® Professional 1066x microSDXC™ UHS-I Cards SILVER Series - Best option for long term use

Lexar® microSDHC/microSDXC UHS-I Cards E-Series - Acceptable option

When you first-time starting your FAS-CAM, please make sure to format your TF Card (SD Card) with your FAS-CAM, see chapter “**7.3.3 Format TF Card (SD Card)**” to continue this option.

2

Safety Information

For user's safety and to avoid property damage, read through this manual and follow these safety instructions to use the product properly.

DANGER Failure to observe the following directions could result in injury, death, or property damage:

General

- ▶ Do NOT disassemble, repair, or modify the product yourself.
- ▶ If any foreign matter gets inside the product, detach the power cord immediately.
- ▶ If smoke or an unusual smell is emitted from the power cord, detach the power cord from the power source immediately.
- ▶ Keep the terminals of the power cord clean.
- ▶ Use the correct input voltage.
- ▶ Do NOT cover the product with any material.
- ▶ Do NOT adjust the product while driving.
- ▶ Do NOT operate the product while driving.
- ▶ Do NOT install the product in a location where the product can interfere with the driver's field of vision.
- ▶ Check with your state and municipal laws before mounting the product to the windshield.
- ▶ Do NOT use a damaged or modified power cord and ONLY use the cords provided by the manufacturer.
- ▶ Use the power cable with the correct connector and make sure the power cable is connected securely and is firmly in place.
- ▶ Do NOT operate the product with wet hands.
- ▶ Do NOT install the product in an environment with high humidity, or combustible gases or liquids.

2

Safety Information

Children and Pets

- ▶ Ensure that the product is out of the reach of children and pets.

Other Information

- ▶ Use the product at a temperature between $-15^{\circ}\text{C} \sim 65^{\circ}\text{C}$ ($5^{\circ}\text{F} \sim 149^{\circ}\text{F}$) and store the product at a temperature between $-25^{\circ}\text{C} \sim 75^{\circ}\text{C}$ ($-13^{\circ}\text{F} \sim 167^{\circ}\text{F}$). The product may NOT function as designed and some permanent physical damages may result if it is operated or stored out of the specified temperature ranges. Such damages are NOT covered by the warranty.
- ▶ Frequently check the product for the proper installation position.
- ▶ Do NOT remove or insert TF Card (SD Card) / Micro SD Card while the camera is powered on
- ▶ Do NOT apply excessive force when pressing the buttons.
- ▶ Do NOT spray cleaning products directly onto the product.
- ▶ Do NOT use chemical cleaners or solvents to clean the product.
- ▶ Clean the product using a clean, soft, and dry fabric.
- ▶ Clean the lens regularly with professional lens cleaning product.
- ▶ Handle with care.
- ▶ Do NOT attempt to insert foreign objects into the device.
- ▶ Avoid excessive humidity and do NOT allow any water to enter the product. Electronic components inside the product may fail if exposed to excessive humidity or water.
- ▶ Do NOT spray water or wax directly onto the product while cleaning inside of the car.

2

Safety Information

Note

- ▶ Depending on the make and model of your car, the power may be constantly supplied to the Dash Mount Camera even when the ignition is turned off. Installation of the device to a continuously powered 12V outlet could result in vehicle battery drainage.
- ▶ This device is designed to record video while the vehicle is in operation. The quality of the video might be affected by weather conditions and the road environment, such as whether it is day or night, presence of street lighting, entering / exiting tunnels, and the surrounding temperature.
- ▶ FAS-CAM is NOT responsible for the loss of any recorded video during operation.
- ▶ Although the device was designed to withstand high-impact car collisions, FAS-CAM does NOT guarantee the recording of accidents when the device is damaged as a result of the accident.
- ▶ Keep the windshield and camera lens clean for optimal video quality. Particles and substances on the camera lens or windshield may reduce the quality of the recorded videos.
- ▶ This device is intended to be used inside the vehicle ONLY.

2

Safety Information

FEDERAL COMMUNICATIONS COMMISSION INTERFERENCE STATEMENT

FAS-CAM

F701 F201

www.fasalliance.com

WARNING: This device complies with Part 15 of the FCC Rules. Operation is subject to the following two conditions: (1) This device may not cause harmful interference, and (2) This device must accept any interference received, including interference that may cause undesired operation.

NOTE: This equipment has been tested and found to comply with the limits for a Class B digital device, pursuant to Part 15 of the FCC Rules. These limits are designed to provide reasonable protection against harmful interference in a residential installation. This equipment generates, uses, and can radiate radio frequency energy and, if not installed and used in accordance with the instructions, may cause harmful interference to radio communications. However, there is no guarantee that interference will not occur in a particular installation. If this equipment does cause harmful interference to radio or television reception, which can be determined by turning the equipment off and on, the user is encouraged to try to correct the interference by one more of the following measures:

Reorient or relocate the receiving antenna.

Increase the distance between the equipment and receiver.

Connect the equipment into an outlet on a circuit different from that to which the receiver is connected.

Consult the dealer or an experienced radio/TV technician for help.

FCC CAUTION: Changes or modifications not expressly approved by the party responsible for compliance could void the user's authority to operate the equipment.

FAS-CAM

3

Product Overview

3.1 Box Content

▶ 3.1.1 Standard Items

Front Camera F701-DR

F701-DR Front Cam

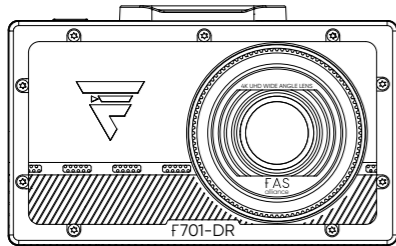

Front Camera Mount

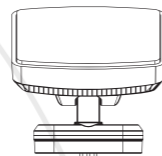

Power Cable (Cigarette Lighter)

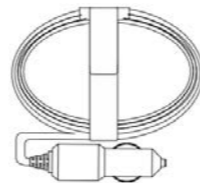

Cable Clips

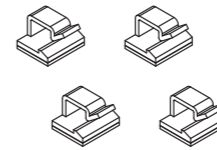

Quick Start Guide



Alcohol & Dry Wipes



Extra 3M Tape

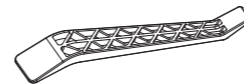

Cable Tucker Tool



Stickers



Installation Manual

Rear Camera F201-IR

F201-IR Rear Cam

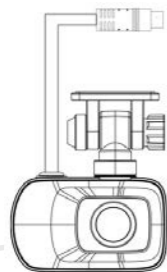

USB-C Extension Cable

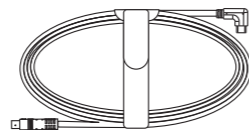

Cable Clips

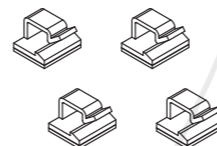

Alcohol & Dry Wipes



Extra 3M Tape

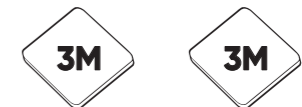

3

Product Overview

3.2 Part Names

▶ 3.2.1 F701-DR Front Camera Front View

Power / Menu / Confirm Button

Power button: Press and hold about 5 seconds to turn on / off the device

Menu Button: Press once to enter the Menu options

Confirm button: to confirm selections while in System Menu

TF Card (SD Card) Slot

Insert memory card into slot

Speaker

Outputs device to indicate the device's status during power-on / shut-down, Menu selection sounds, and playback audio recording during video playback

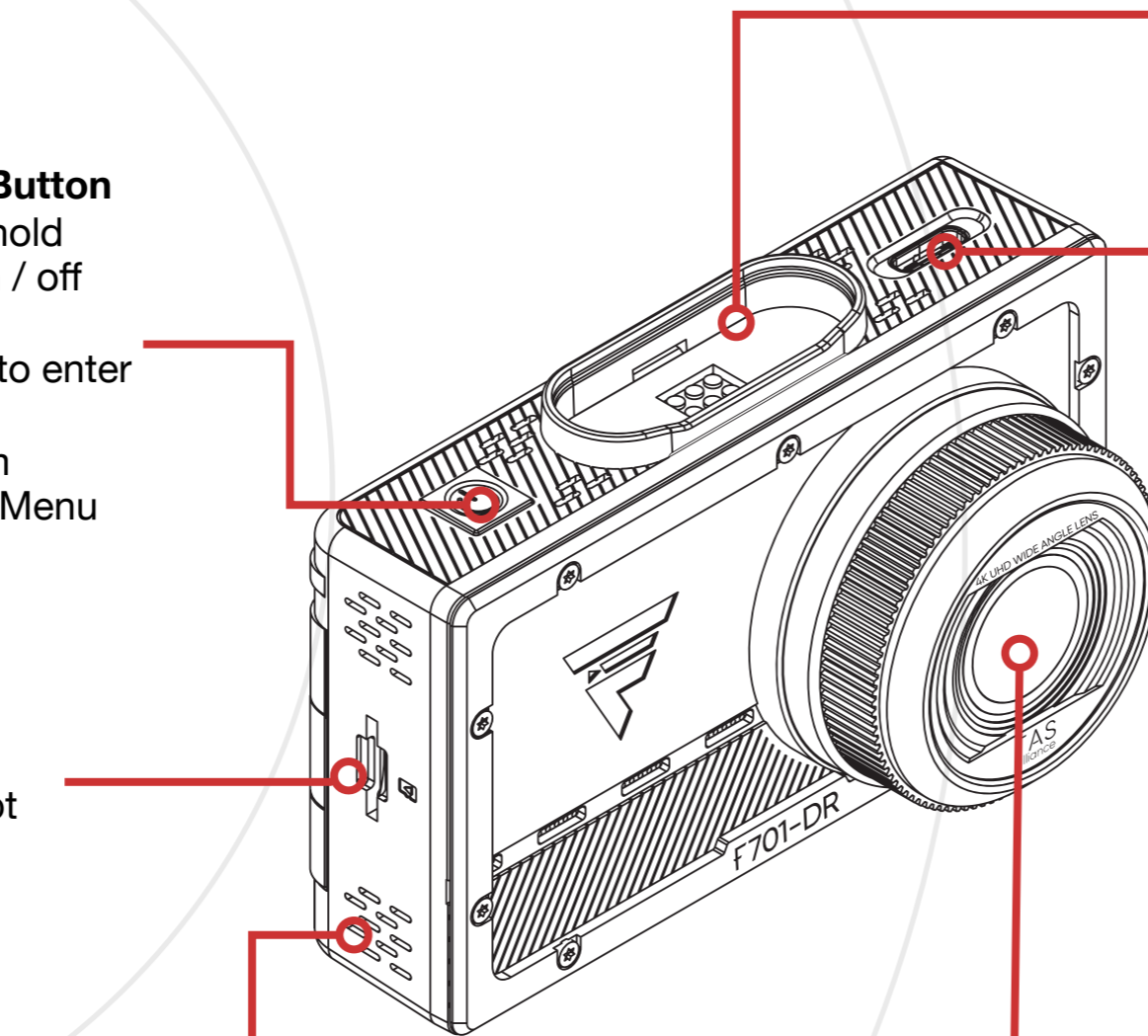

Magnetic Front Camera Mount Bracket Slot

Connects the Front Camera GPS Mount Pin Connector Side to the magnetic mount in order to power supply and connect to the GPS

Rear Camera Cable Port (if Rear Camera is purchased)

Connect with the *F201-IR Rear Camera ONLY* thru the USB-C Extension Cable included in the F201-IR box

Front Camera Lens

Provides users a 4K full-view recording of 5 road lanes

3

Product Overview

3.2 Part Names

▶ 3.2.2 F701-DR Front Camera Rear View and Dimension

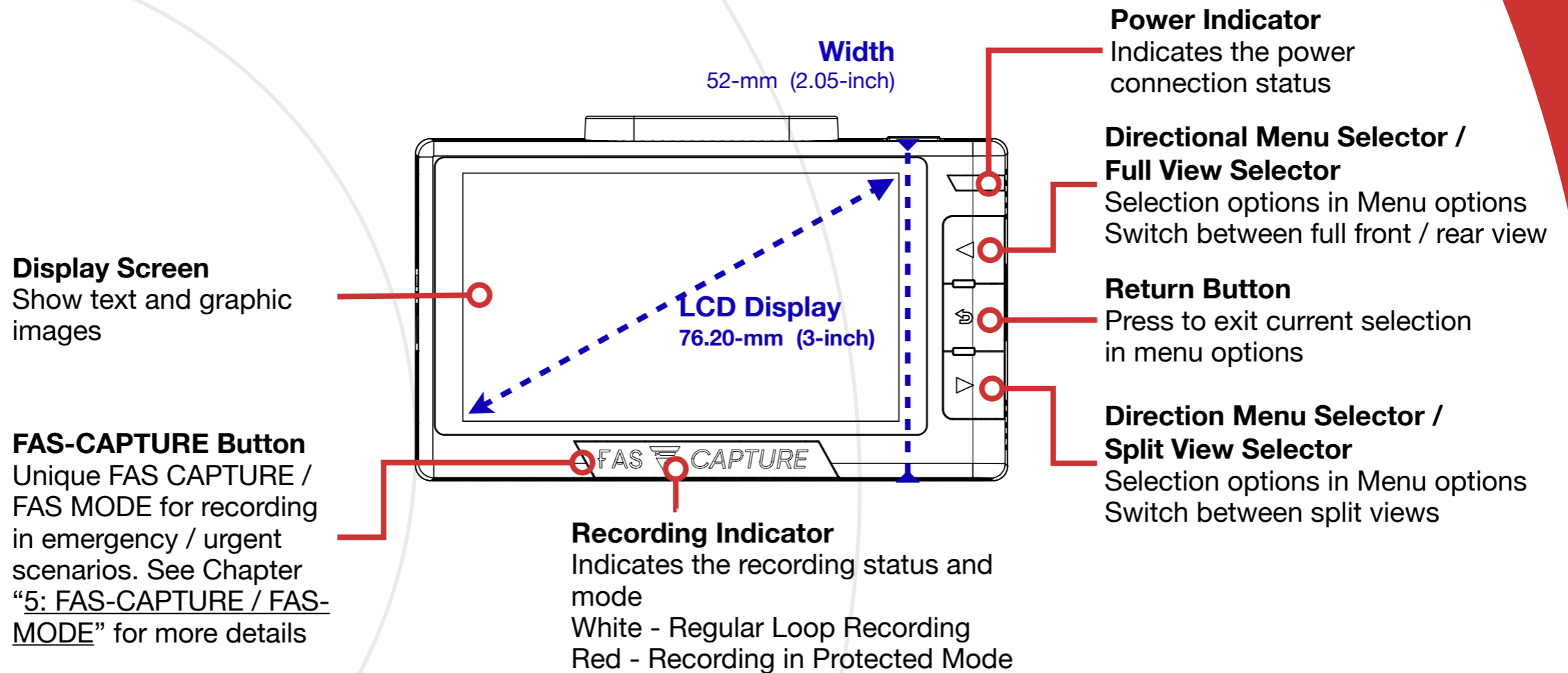

F701-DR Dimension	Length	Width	Height	LCD Display
Millimeter	90	52	22.97	76.20
Inch	3.54	0.90	2.05	3

3

Product Overview

3.2 Part Names

▶ 3.2.3 F701-DR Front Camera Bottom View and Dimension

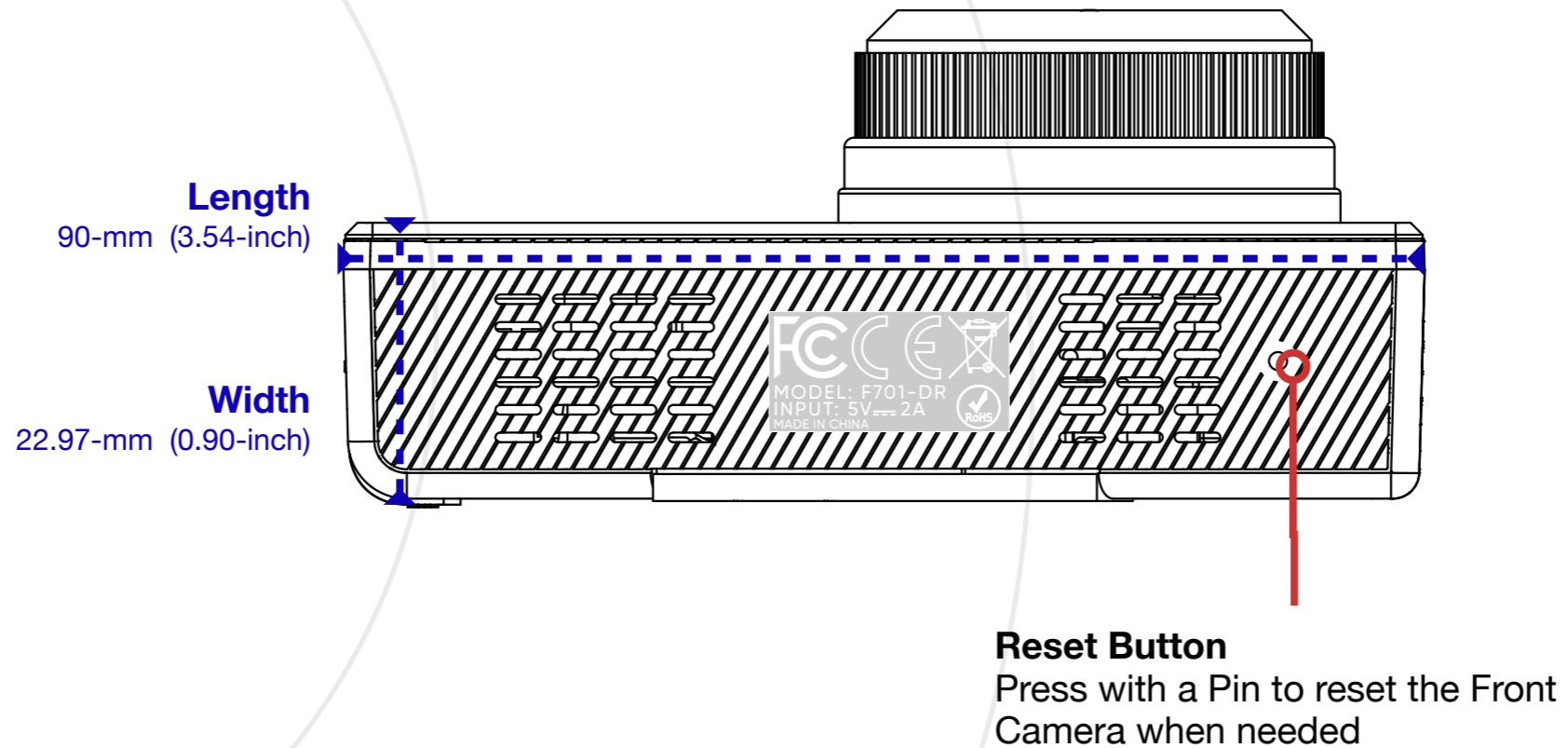

F701-DR Dimension	Length	Width	Height
Millimeter	90	52	22.97
Inch	3.54	0.90	2.05

3

Product Overview

3.2 Part Names

▶ 3.2.4 F701-DR Front Camera View Display Icon Names

Icon Name Graph

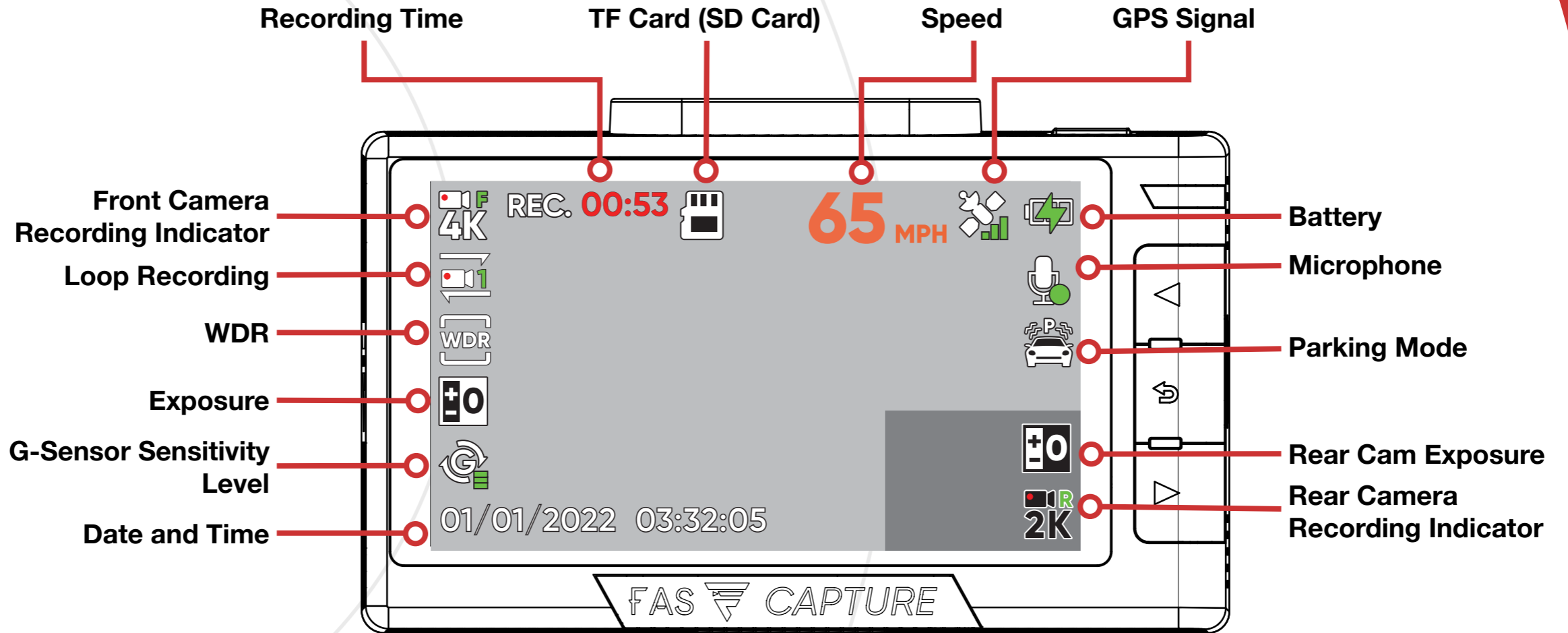

3

Product Overview

3.2 Part Names

▶ 3.2.4 F701-DR Front Camera View Display Icon Names

Icon Name Chart

Icon	Description	Icon	Description
	Front View Cam 4K Recording Enable		No GPS Signal
	Rear View Cam 2K Recording Enable		GPS Signal Weak
	Audio Recording Disabled		GPS Signal Moderate
	Audio Recording Enabled		GPS Signal Strong
	Battery Power Depleted		G-Sensor Sensitivity Level Low
	Battery Power 33% Available		G-Sensor Sensitivity Level Moderate
	Battery Power 66% Available		G-Sensor Sensitivity Level High
	Battery Power 100% Available		Loop Recording 1 Minute Length
	Constant Power Source Connected		Loop Recording 2 Minute Length
	Front / Rear Cam Exposure -3		Loop Recording 3 Minute Length
	Front / Rear Cam Exposure -2		Parking Mode Disabled
	Front / Rear Cam Exposure -1		Parking Mode G-Sensor & Motion Enabled
	Front / Rear Cam Exposure 0		Parking Mode G-Sensor Enabled
	Front / Rear Cam Exposure +1		Parking Mode Motion Enabled
	Front / Rear Cam Exposure +2		TF Card in Use
	Front / Rear Cam Exposure +3		TF Card NOT Available
	WDR Enabled		TF Card Full

3

Product Overview

3.2 Part Names

3.2.5 F701-DR Front Camera Dash Camera Mount and Dimension

Front View

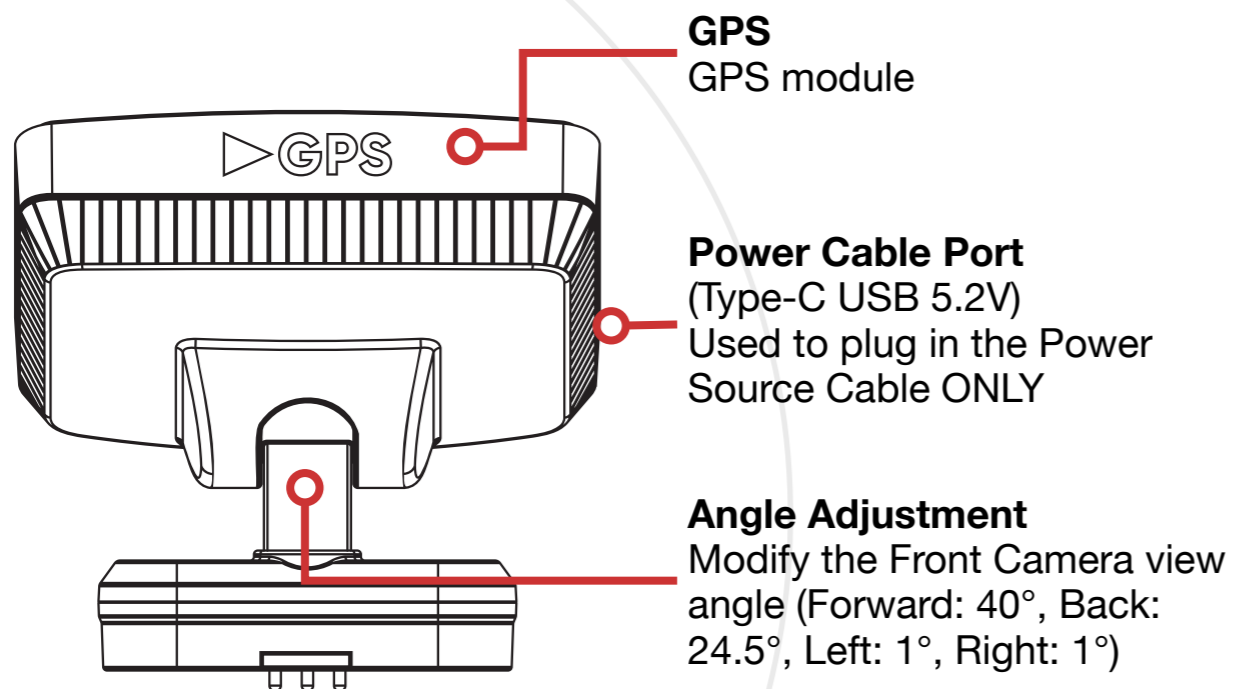

Rear View

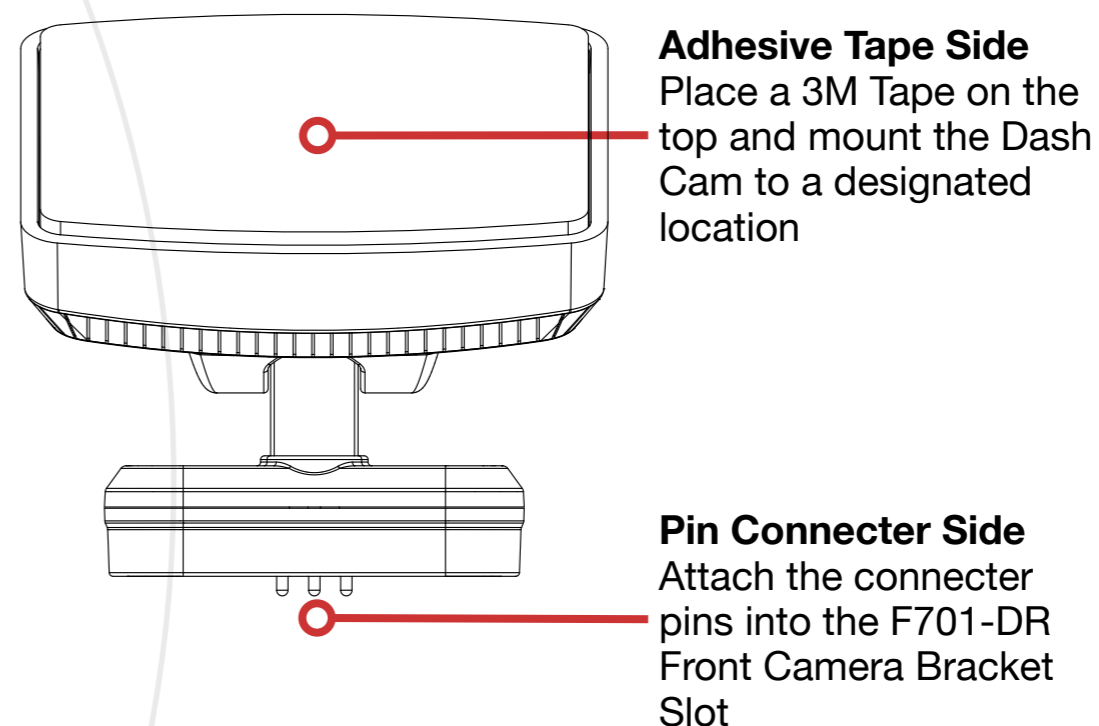

Side View

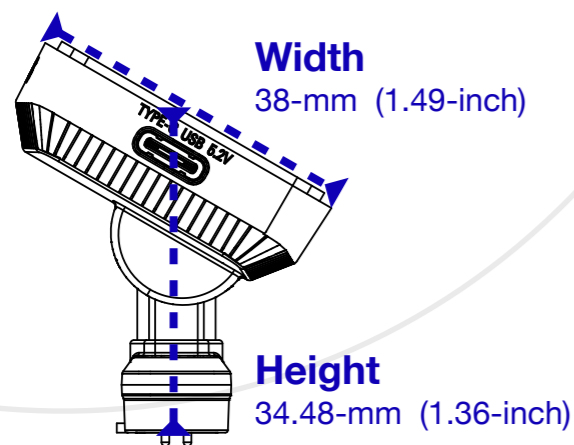

Bottom View

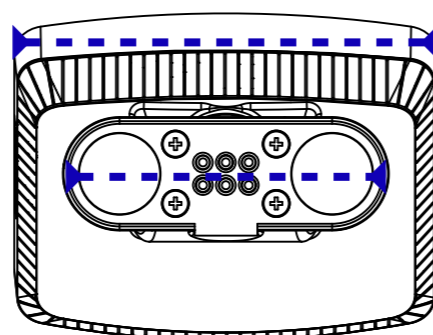

Length
47-mm (1.85-inch)

Connector
36.12-mm (1.42-inch)

F201-IR Dimension	Length	Width	Height	Connector
Millimeter	47	38	34.48	36.12
Inch	1.85	1.49	1.36	1.42

3

Product Overview

3.2 Part Names

▶ 3.2.6 Rear Camera (Optional) Front View and Dimension

Adhesive Tape Side

Place a 3M Tape on the top and mount the bracket to a designated location

F201-IR Camera Cable

Transfer data and deliver electricity power supply

Camera Lens

Records in 2K

Angle Adjustment

Modify the F201-IR Rear Camera view angle

Angle Adjustment Locking Knob

Lock the view angle of F201-IR Rear Camera

Night Vision Sensor Module

Enhance image quality in the dark environment or night view

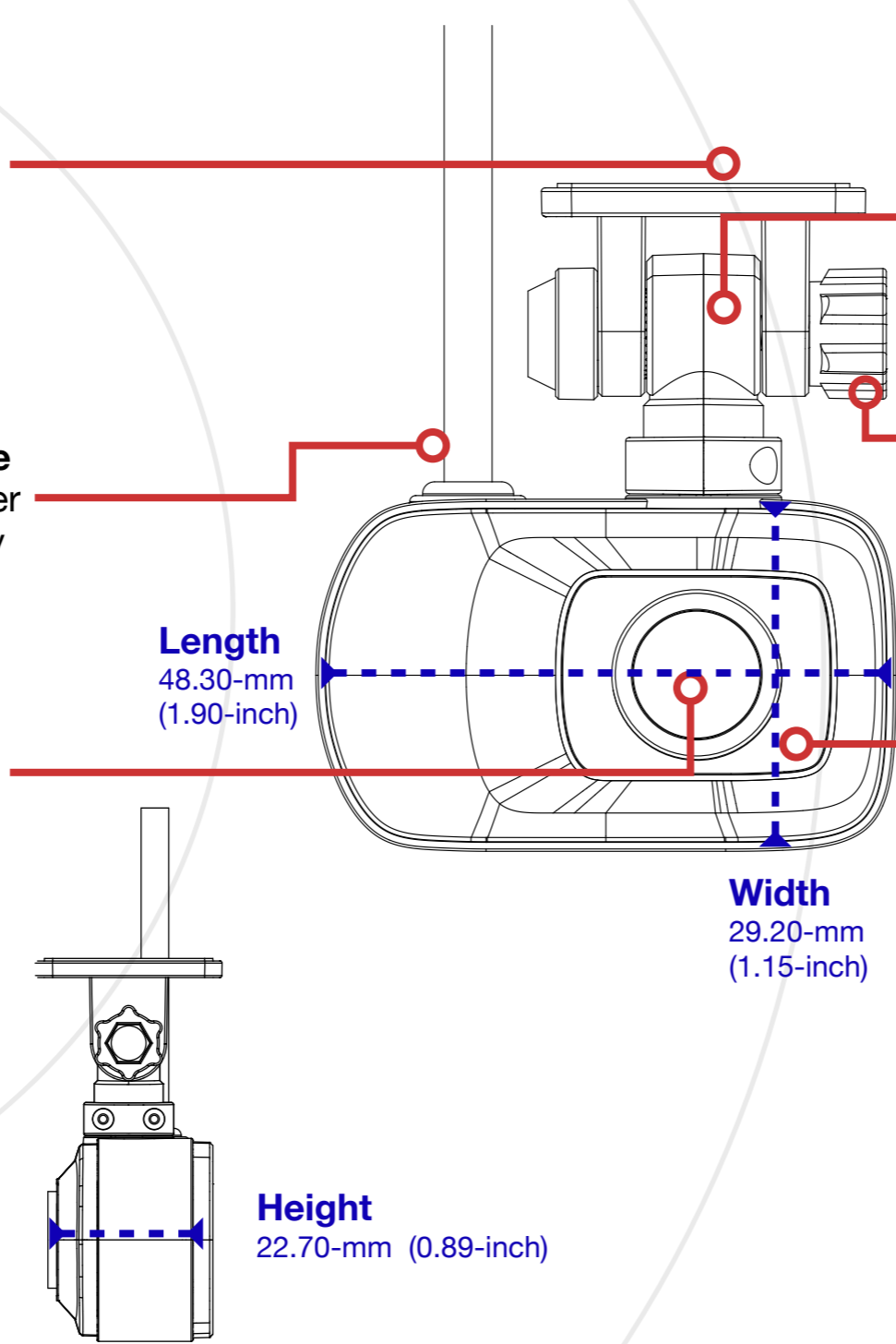

Length
48.30-mm
(1.90-inch)

Width
29.20-mm
(1.15-inch)

Height
22.70-mm (0.89-inch)

F201-IR Dimension	Length	Width	Height
Millimeter	48.30	29.20	22.70
Inch	1.90	1.15	0.89

4 Installation

4.1 F701-DR Front Camera Installation

▶ 4.1.1 Insert TF Card (SD Card)

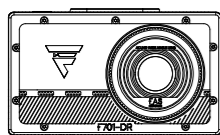

***Memory card not included.**

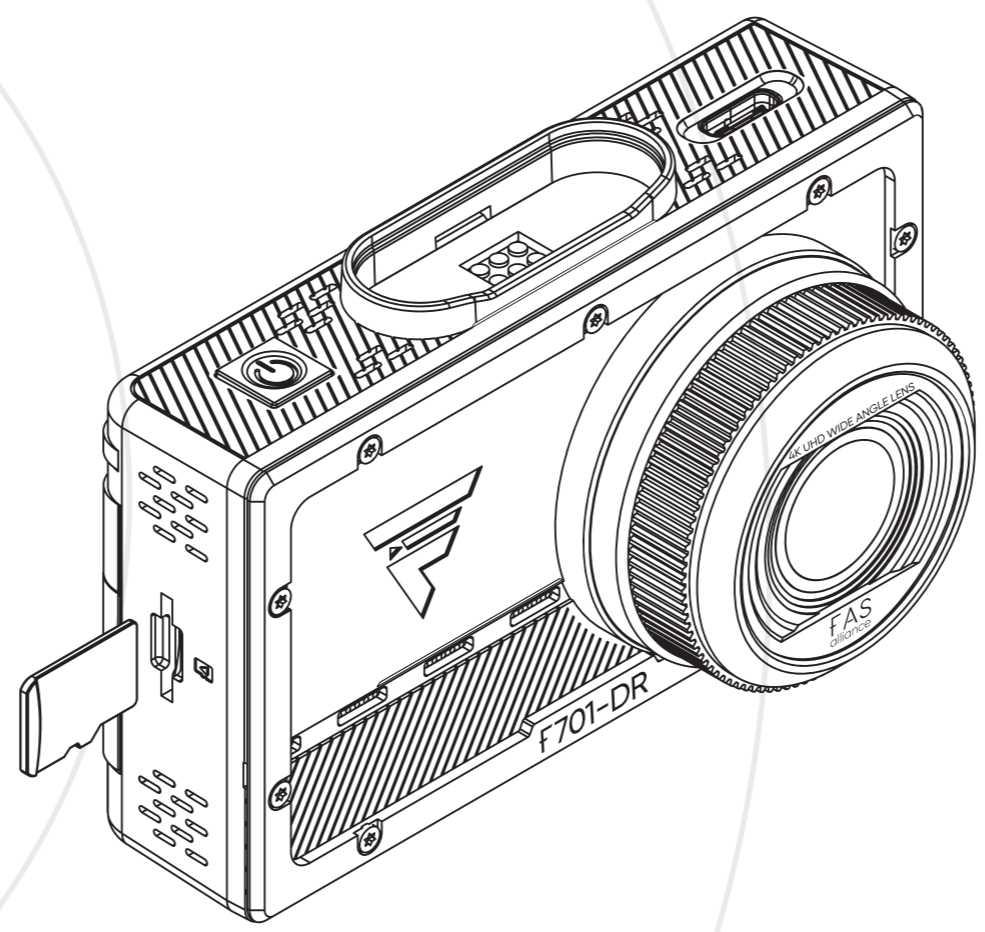

- ▶ Insert the memory card into the memory card slot in the front camera.

Recommended Brand

Lexar® Professional 1066x microSDXC™ UHS-I Cards SILVER Series - Best option for long term use

Lexar® microSDHC/microSDXC UHS-I Cards E-Series - Acceptable option

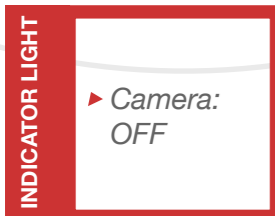

4

Installation

4.1 F701-DR Front Camera Installation

4.1.2 Unit Test

Unit test helps users ensure that camera functions are working properly before they proceed to the installation.

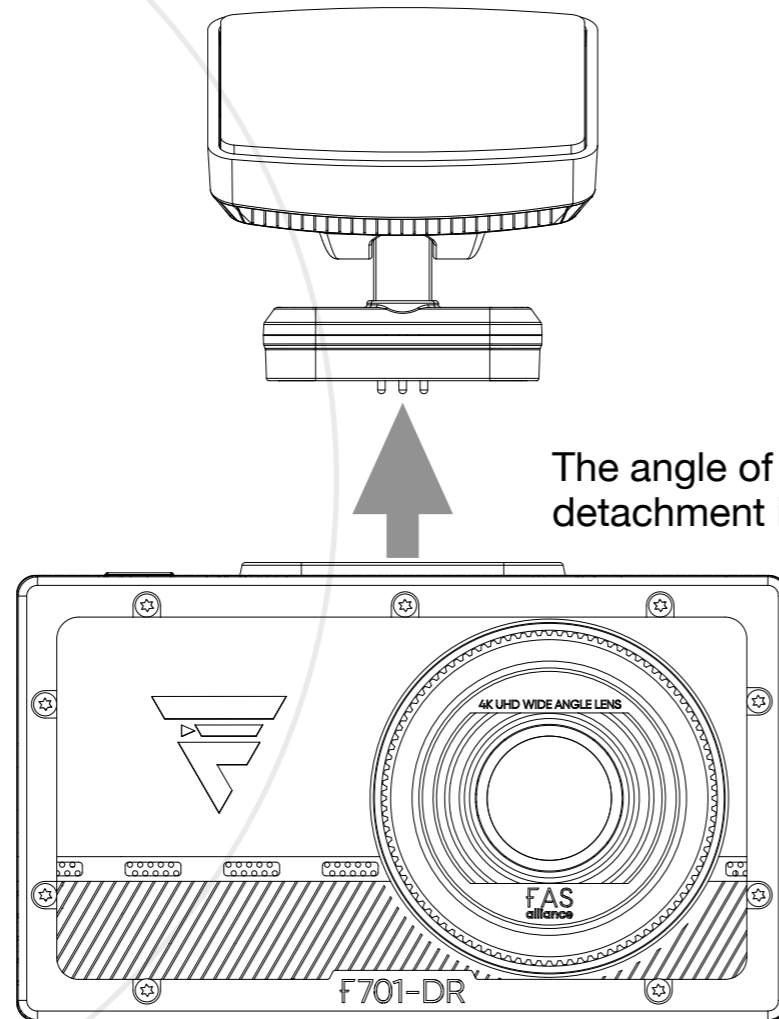
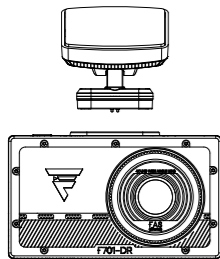

The angle of attachment / detachment is about 35°

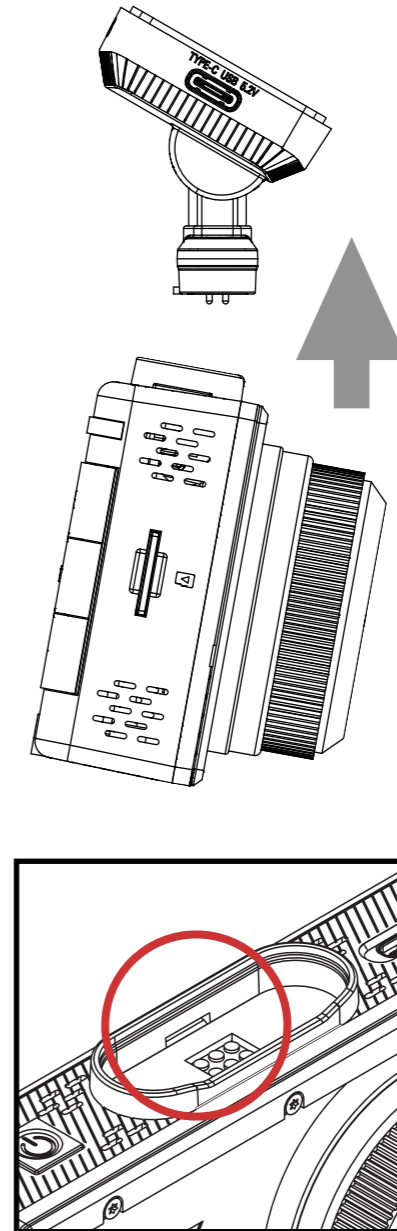

- ▶ Connect the front camera to the front camera mount.
- ▶ The angle of attachment / detachment is about 35°.
- ▶ There is a small indentation where the mount hook attaches. Be careful not to snap off the hook by forcing an incorrect angle

INDICATOR LIGHT

▶ Camera:
OFF

FAS-CAM

4

Installation

4.1 F701-DR Front Camera Installation

4.1.2 Unit Test

*Skip this step if you only purchased the F701- DR front camera.

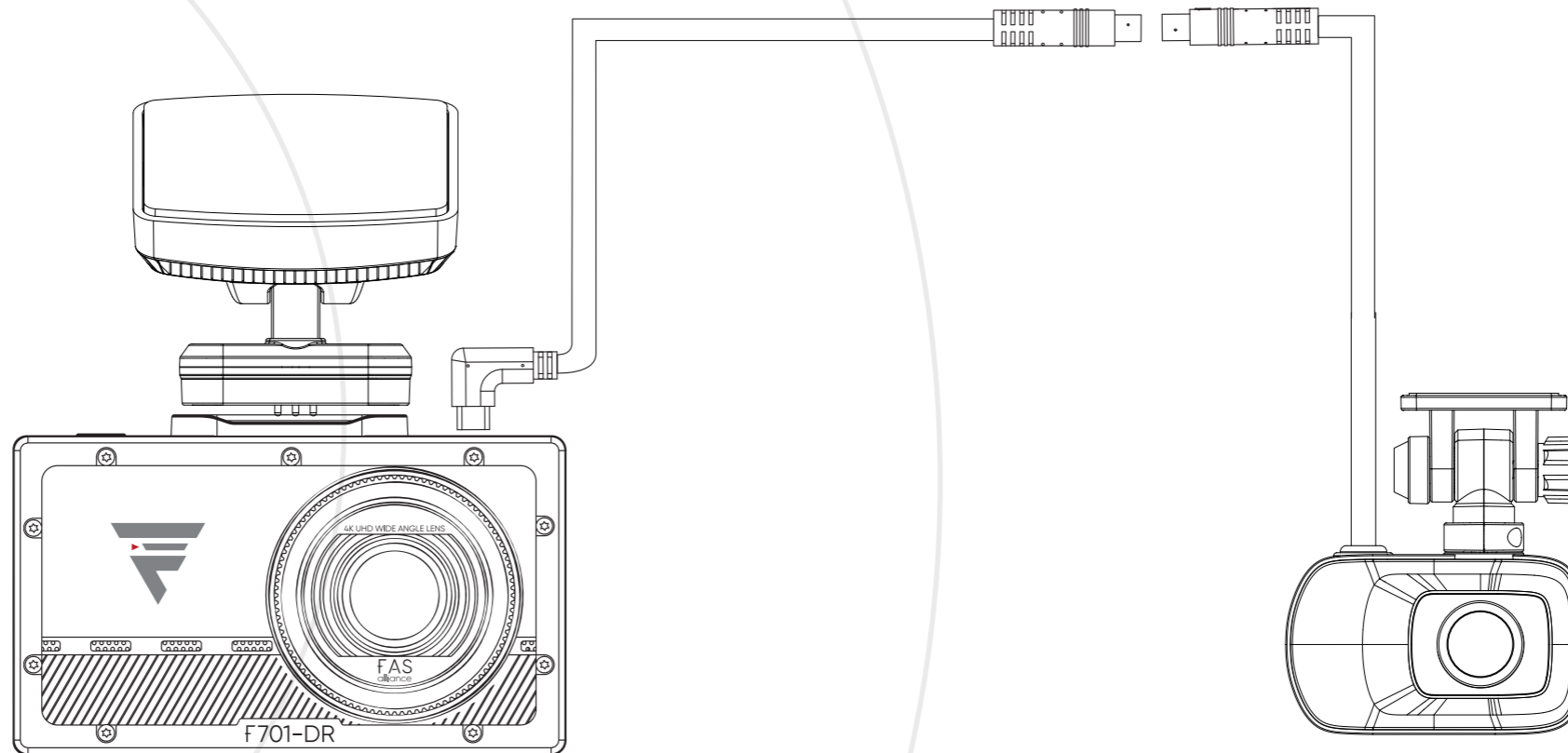
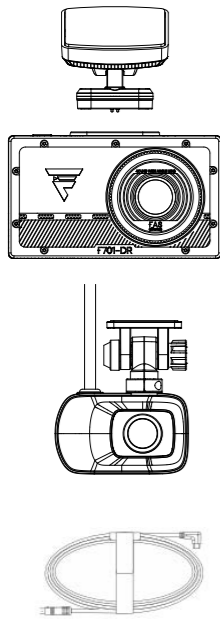

- ▶ Locate the rear camera and rear camera USB-C Extension Cable. Connect the front camera and the rear camera using the rear camera USB-C Extension Cable.

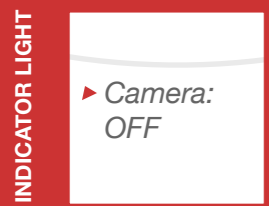

4

Installation

4.1 F701-DR Front Camera Installation

4.1.2 Unit Test

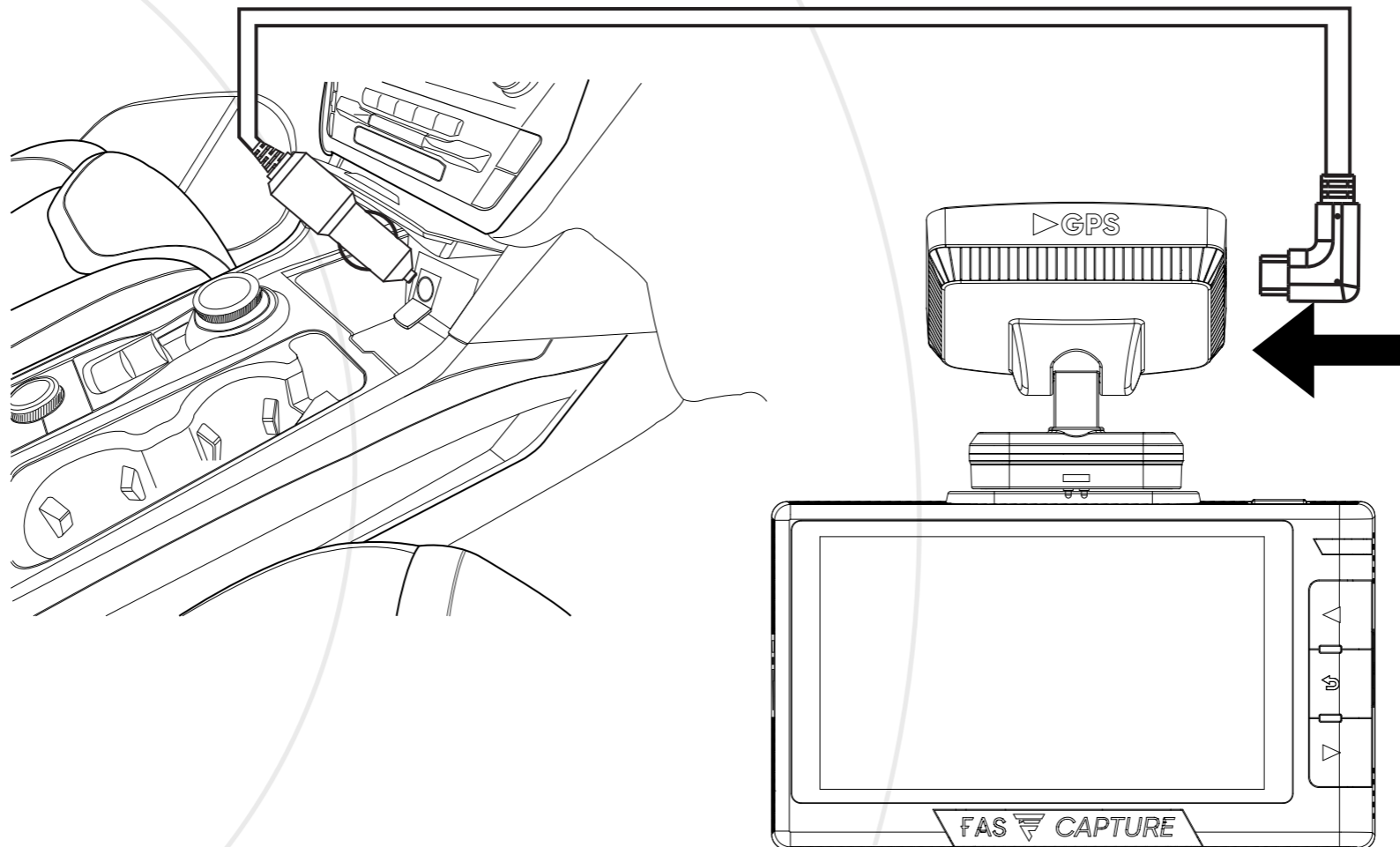
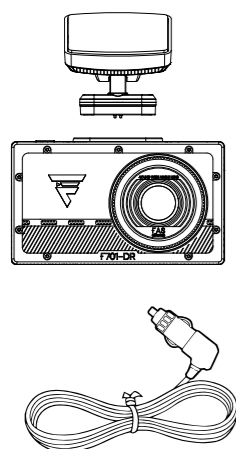

- ▶ Locate the power cable. Connect the power cable to the car cigarette lighter socket and the other end of the power cable to the front camera mount.

INDICATOR LIGHT

▶ Camera:
OFF

FAS-CAM

4

Installation

4.1 F701-DR Front Camera Installation

4.1.2 Unit Test

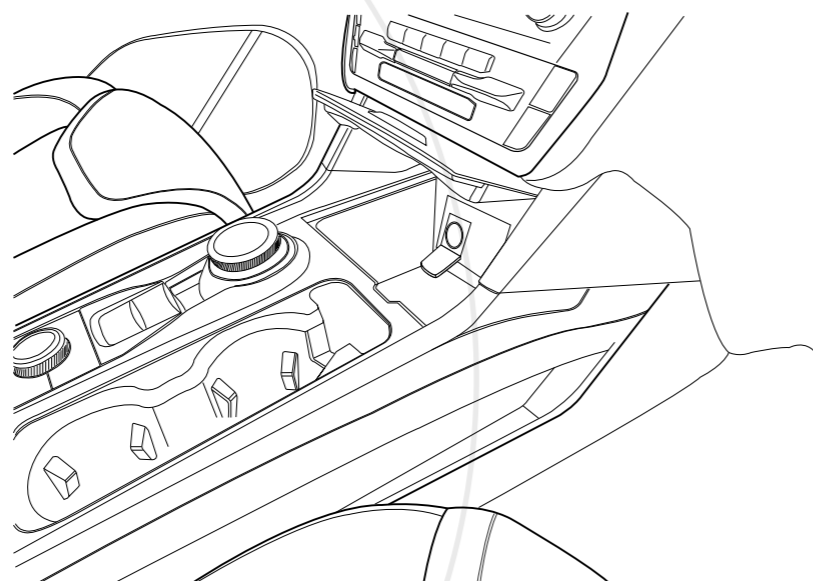
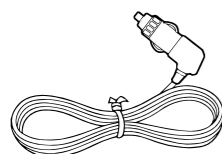
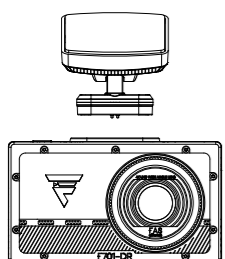

- ▶ Power Indicator: ON
- ▶ Recording Indicator: ON - RED (while recording during protected mode)

- ▶ Power on the front camera by starting the vehicle ignition.
- ▶ Remove protective covering on camera screen and lens.

INDICATOR LIGHT

- ▶ Power: ON
- ▶ Recording: WHITE - ON

FAS-CAM

4

Installation

4.1 F701-DR Front Camera Installation

4.1.2 Unit Test

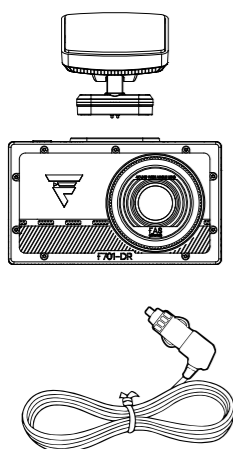

Startup



1st



2nd

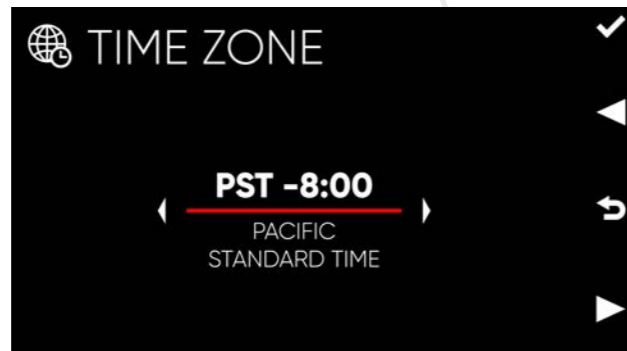

3rd

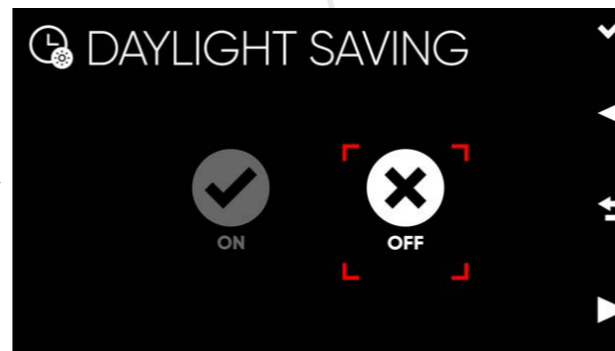

4th

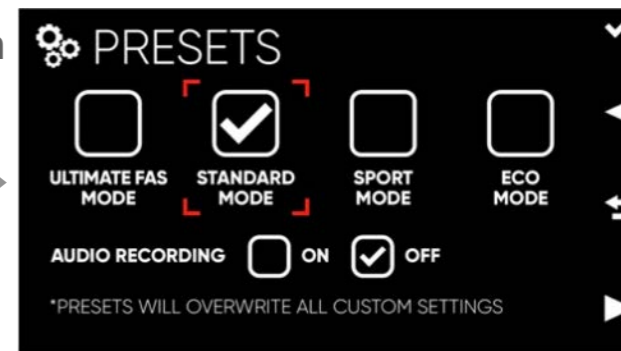

- ▶ Language: select a preferred system language.
- ▶ Time Zone: select your time zone.
- ▶ Daylight Saving: select ON or OFF base on your time zone and local regulation.
- ▶ Presets: “Eco Mode”, and Audio Recording “OFF” will be the default setting. We recommend to select “Standard Mode” during this setup.

Refer to Chapters:
[7.1.1.2 Presets Mode](#)
[7.1.1.2 & 7.2.3 Audio Recording](#)
[7.3.1 Date & Time settings](#)
in this User Manual for the comprehensive feature setup instruction.

INDICATOR LIGHT

- ▶ Power: ON
- ▶ Recording: WHITE - OFF

FAS-CAM

4

Installation

4.1 F701-DR Front Camera Installation

4.1.2 Unit Test

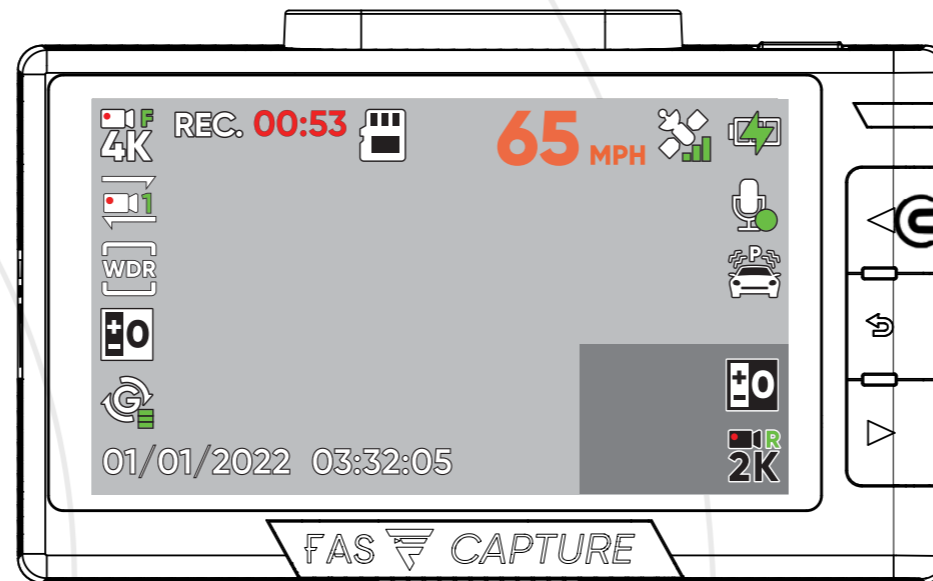
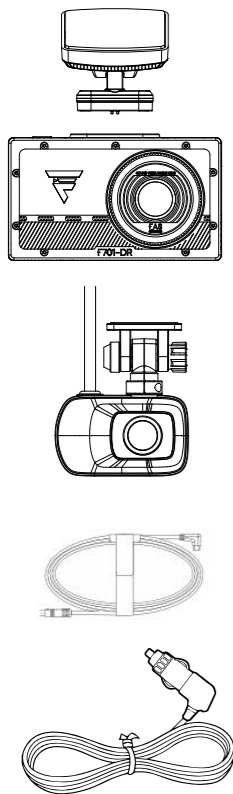

Full View Selector

- ▶ After complete the initial setup, system will automatically switch to Main View.
- ▶ If you purchased the F201 rear cam, use the ▷ button to switch between front and rear views.
- ▶ Check “Front View” and “Rear View” to confirm they are being displayed.
- ▶ If any of the views fails to show, or if you experience any malfunction. Please review chapter [“10: Troubleshoot”](#) in this User Manual.

INDICATOR LIGHT

- ▶ Power: ON
- ▶ Recording: WHITE - ON

FAS-CAM

4

Installation

4.1 F701-DR Front Camera Installation

4.1.2 Unit Test

- ▶ We recommend formatting the TF Card (SD Card) using the camera's internal format application before initial recording.

Enter Menu

Press the Power Button Once

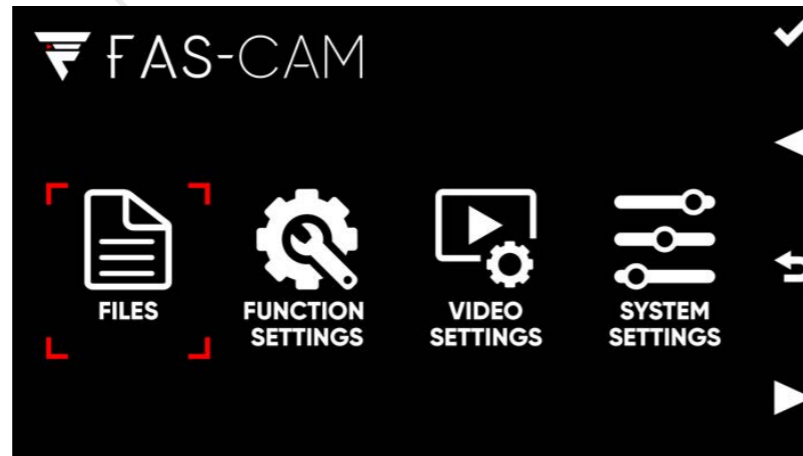

1st

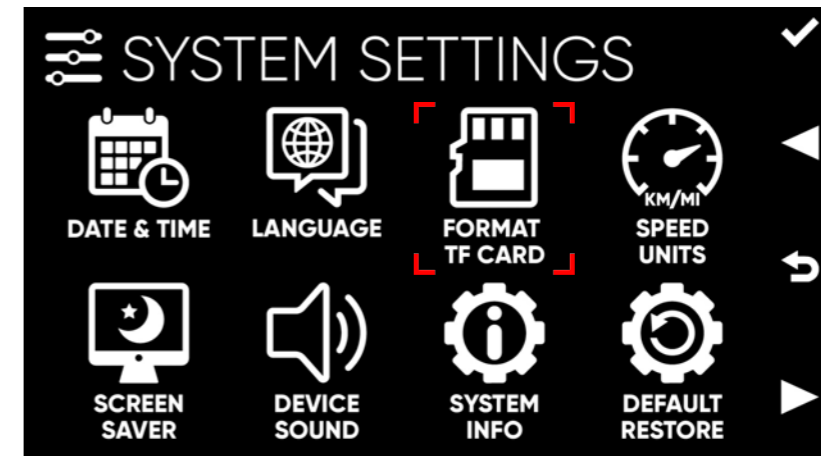

2nd

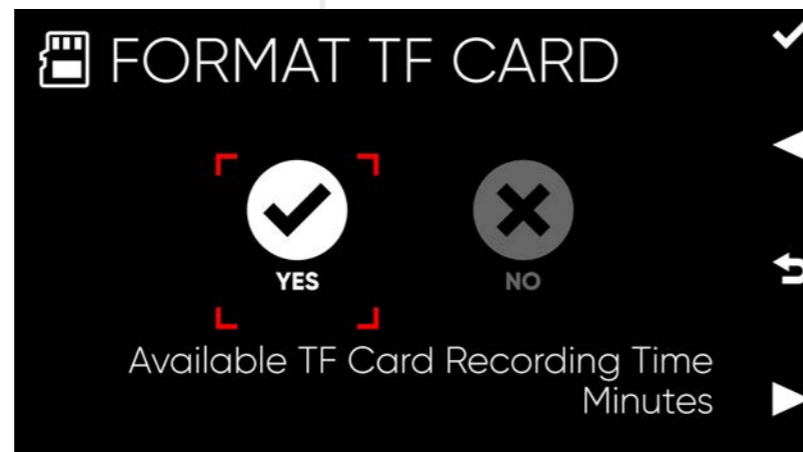

3rd



- ▶ Enter *MENU*
- ▶ Navigate to **SYSTEM SETTINGS** ▶ **FORMAT TF CARD**
- ▶ Select **YES**
- ▶ A “WARNING MESSAGE” will pop-up
- ▶ Select option and press  key to confirm

NOTE: The estimated “Available TF Card (SD Card) Recording Time (Minutes)” info will be displayed at the bottom of the page

4

Installation

4.1 F701-DR Front Camera Installation

4.1.2 Unit Test

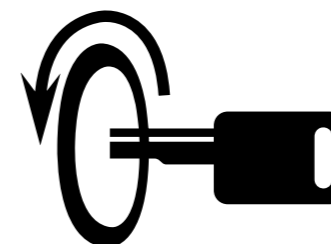
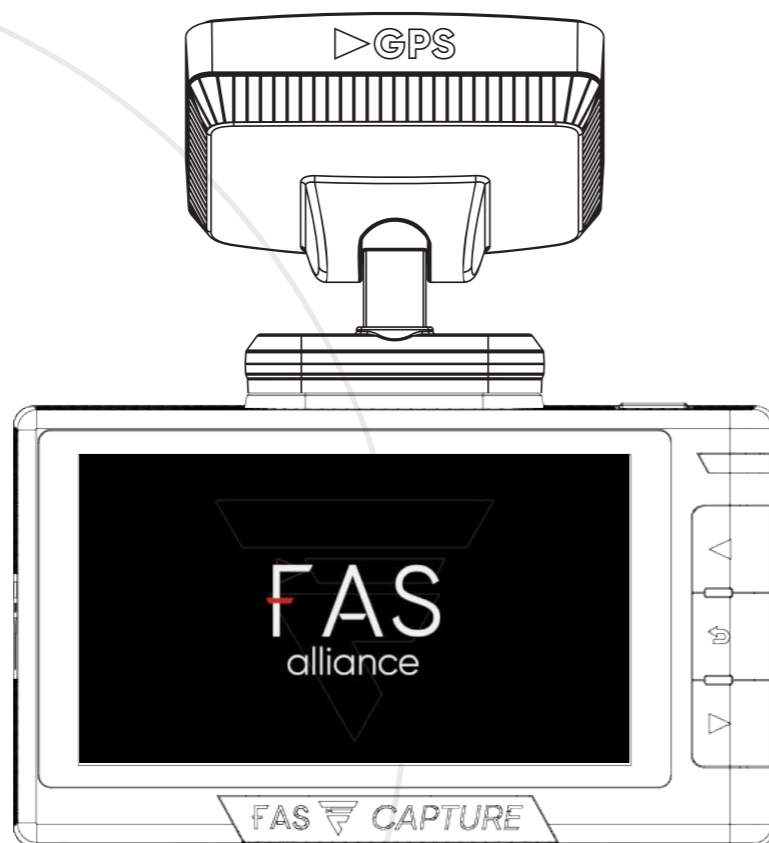
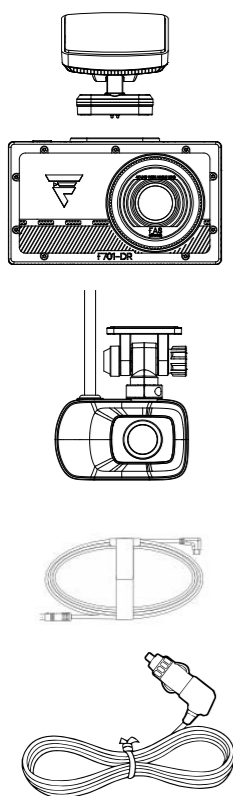

Power-off the vehicle ignition

- ▶ Power off the front camera by turning off the vehicle.
- ▶ Disconnect the power cable.
- ▶ Disconnect the rear camera cable from both the rear camera and front camera.
- ▶ Keep the mount attached to the front camera.



FAS-CAM

4 Installation

4.1 F701-DR Front Camera Installation

4.1.3 Front Camera Pre-Alignment

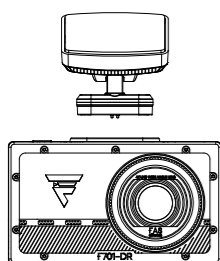

* Check with your state and municipal laws before mounting the product to the windshield

This step helps users find their desired front camera placement before using 3M adhesive tape to attach the mount to the windshield.

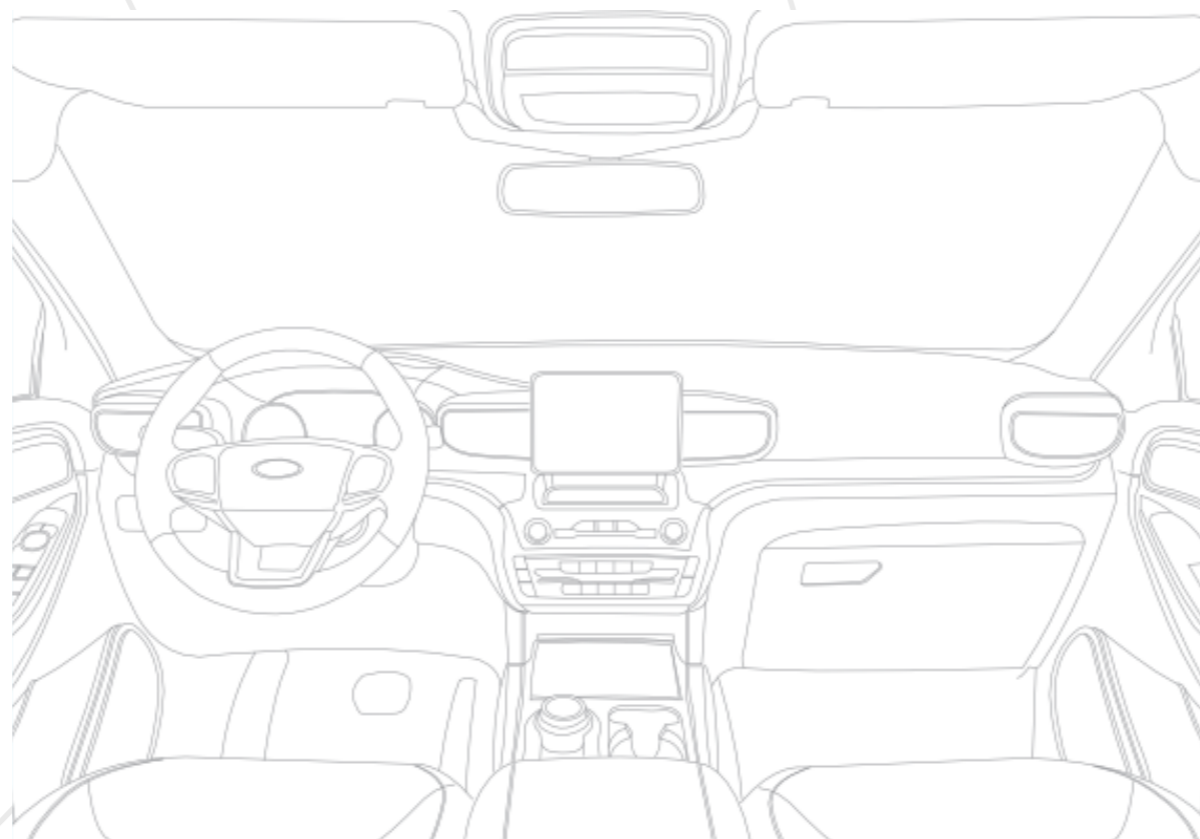

- ▶ While the front camera is connected to the front camera mount, determine the desired placement on the windshield.



4

Installation

4.1 F701-DR Front Camera Installation

4.1.4 Surface Preparation

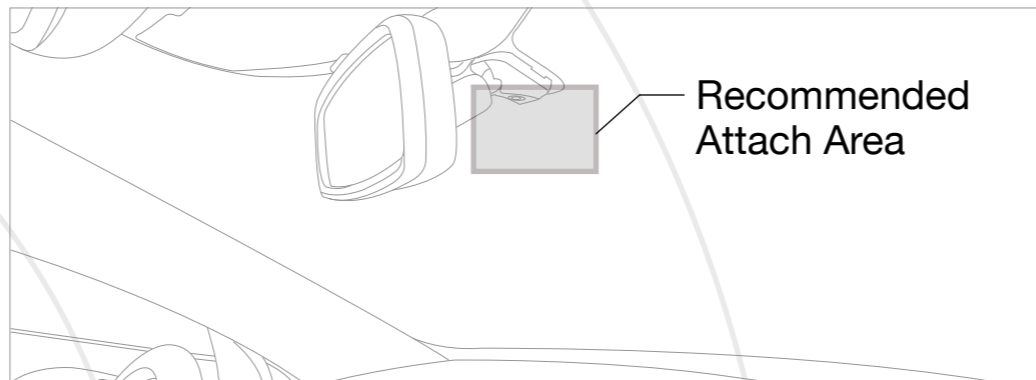
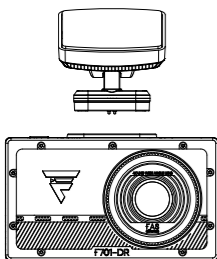

- ▶ Before attaching the mount, use the alcohol pads to wipe down the area on the windshield.

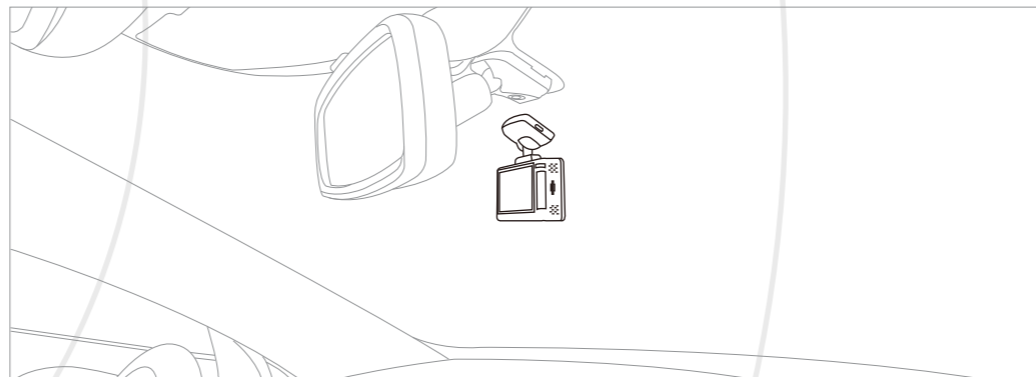

- ▶ After using the alcohol pads, use the cleaning cloth to dry the area.



4

Installation

4.1 F701-DR Front Camera Installation

4.1.5 Optional Electrostatic Film

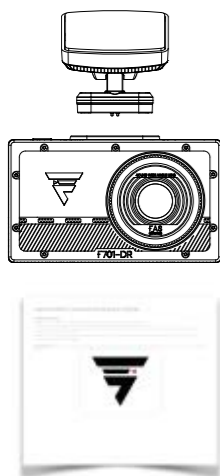

ELECTROSTATIC FILM FOR THE 3M STICKY MOUNT

INSTRUCTIONS:

1. Measure and decide the designated installation area using the camera's viewfinder.
2. Thoroughly clean the applicable area using the alcohol wipe then dry with the dry wipe provided.
3. Peel the top of the film & apply the sticky side on the windshield. Apply pressure to the film and remove any air bubbles for a strong bond to the windshield.
4. Securely attach the FAS-CAM Mount to the windshield on top of the electrostatic film in the dotted box and adjust the view angle accordingly.

IMPORTANT: Please ensure that the camera's field of view (lens) is NOT overlapping the electrostatic film. Otherwise, the video will appear blurry.



- ▶ The electronic film is an optional step for those who do not wish to apply the 3M tape directly onto the window. Using this static film, you can apply the mount on the designated boxed area.
- ▶ Make sure the box on the electric static film is on the area you selected for the mount placement.
- ▶ Peel the backing off the static film and apply it smoothly onto the clean surface. Push out any residual bubbles.
- ▶ Peel off the 3M adhesive backing from the bottom of the mount and attach the mount into the indicated box on the static film or the desired location on the windshield if applying directly.

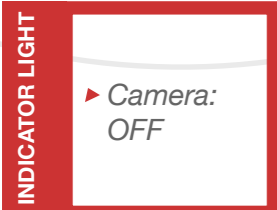

4

Installation

4.1 F701-DR Front Camera Installation

4.1.6 Power Cord Wiring Placement - Cigarette Lighter

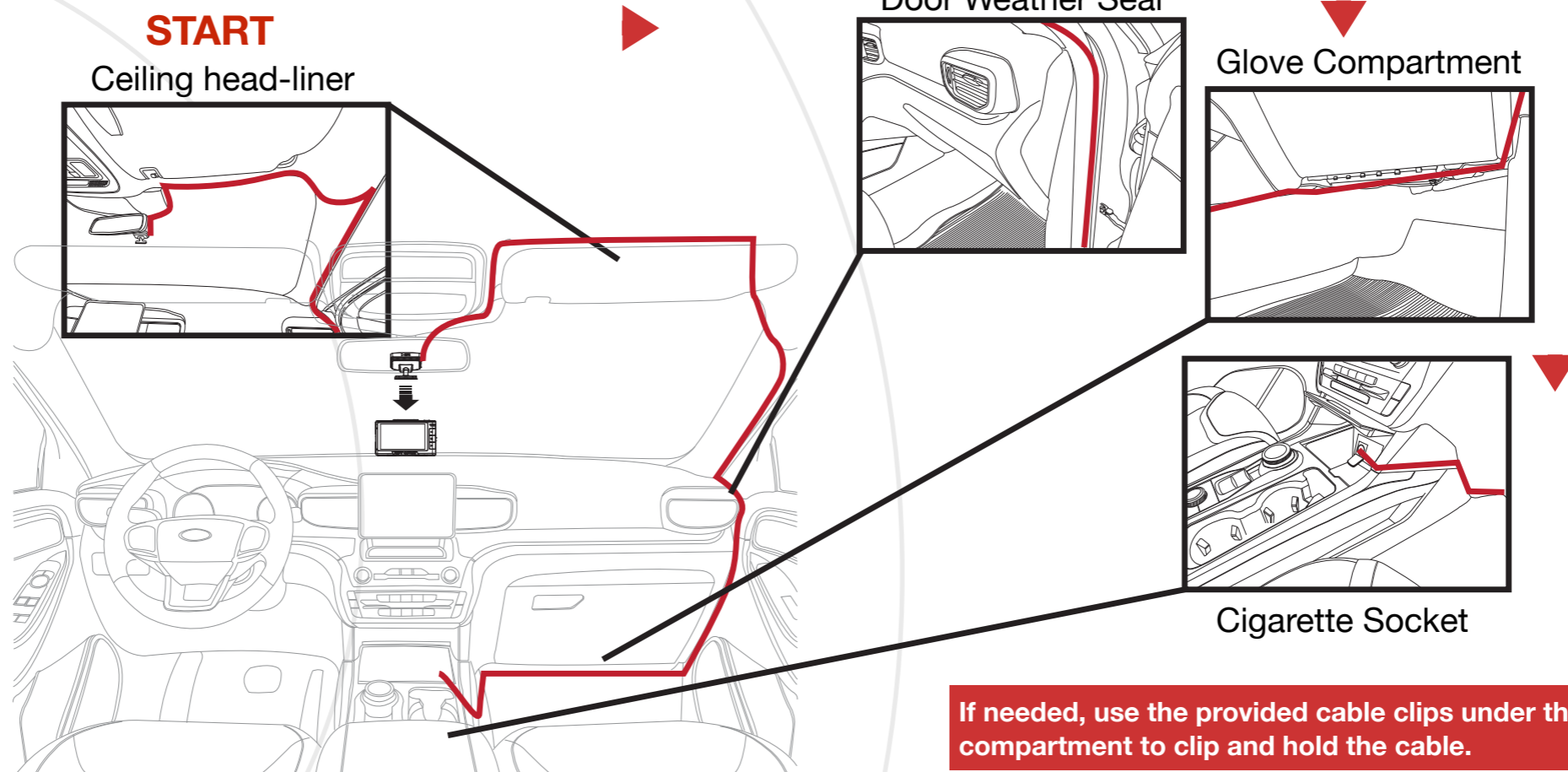
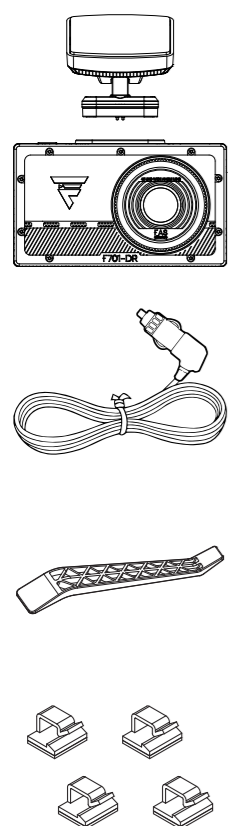

- ▶ Dismount the front camera from the front camera mount.
- ▶ Extend the power cable and connect it to the mount.
- ▶ Place the power cable in between the vehicle body and the vehicle interior trim by using the cable tucker tool provided.
- ▶ Plug the power cable into the cigarette lighter socket outlet.
- ▶ Remount the front camera to the front camera mount.

Depending on the vehicle types and models, cable routing might be done either through the driver side or the passenger side. However, for most of the vehicle types and models, the passenger side usually provides less obstacles than the driver side. Determine the path you would wish to tuck the cables.

INDICATOR LIGHT

▶ Camera:
OFF

FAS-CAM



Video Tutorials



Follow along with our installation video for a smoother installation

4

Installation

4.2 F201-IR Rear Camera Installation

4.2.1 Rear Camera Pre-Alignment & Surface Preparation

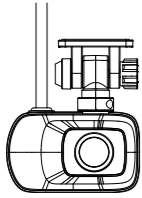

***Skip this step if you only purchased the F701- DR front camera.**

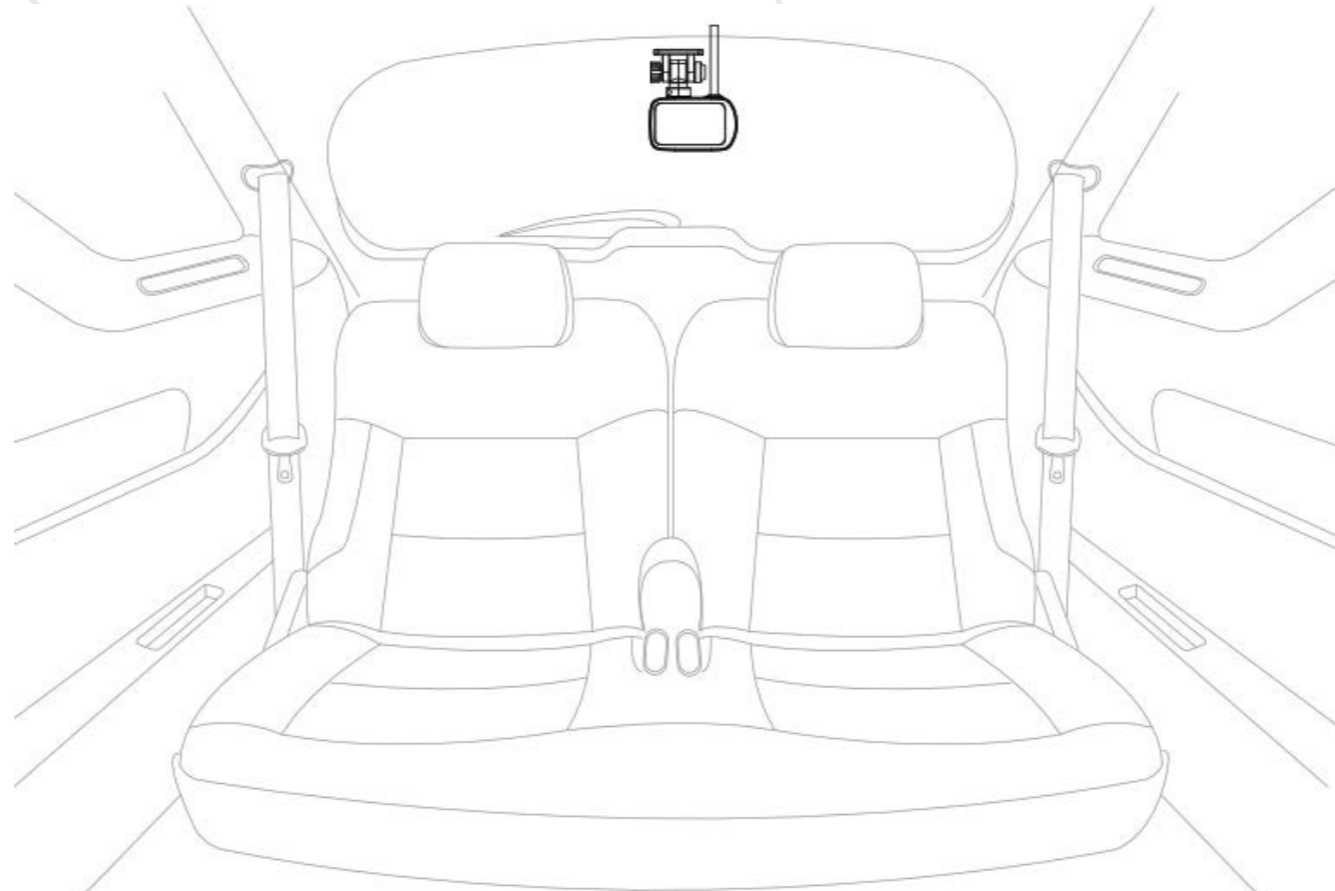

- ▶ Place the rear camera on the back windshield to find the desired placement location.
- ▶ Before attaching the mount, use the alcohol pads to wipe down the area on the windshield and use the cleaning cloth to dry the area.

INDICATOR LIGHT

▶ Camera:
OFF

Rear camera can also be used as an internal camera to view the inside of the vehicle and can be attached anywhere the user sees fit. Rear camera installation guide is only a suggestion.

4

Installation

4.2 F201-IR Rear Camera Installation

4.2.1 Rear Camera Installation

***Skip this step if you only purchased the F701- DR front camera.**

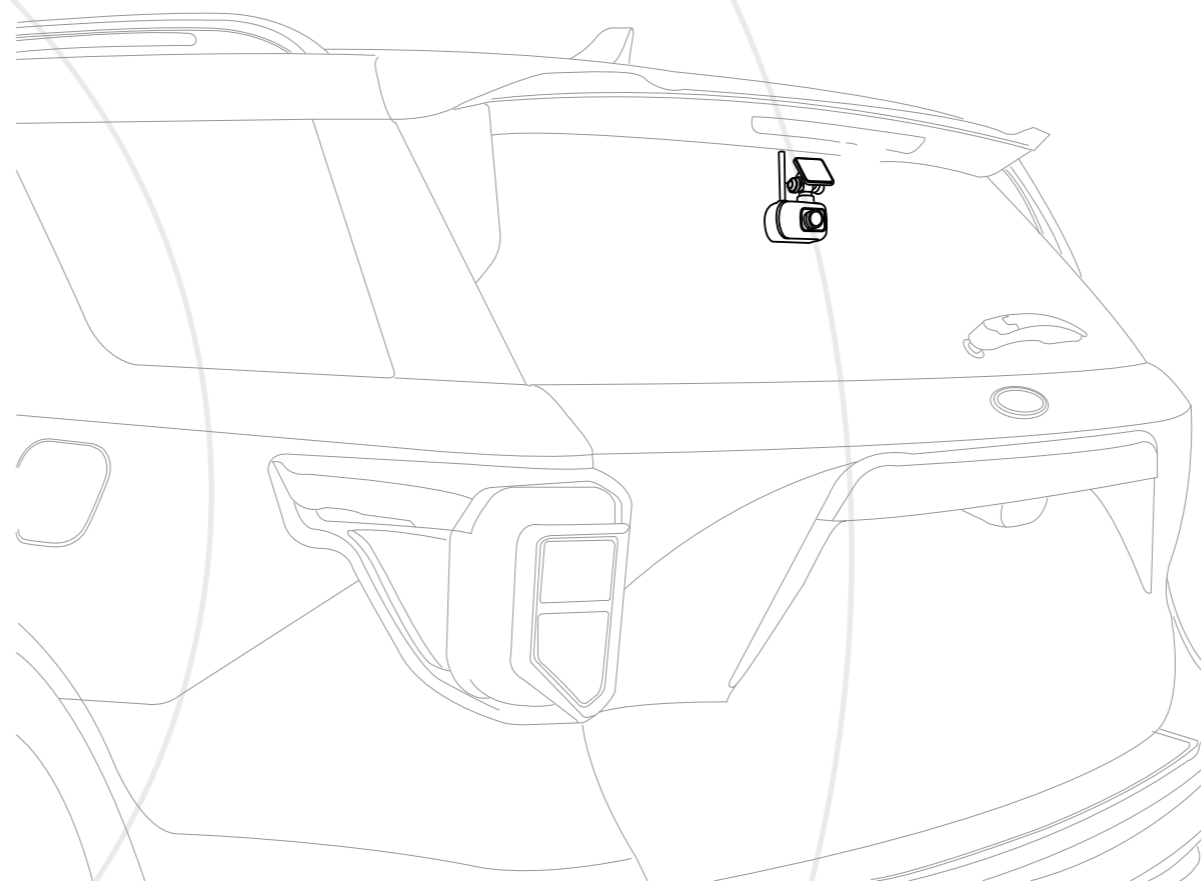
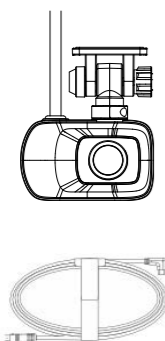

- ▶ Peel off the backing of the pre-attached 3M adhesive on the rear camera. Attach the rear camera to the desired location on the back windshield.

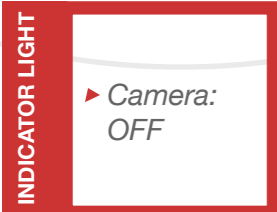

FAS-CAM

4

Installation

4.2 F201-IR Rear Camera Installation

4.2.3 Rear Camera Wiring Route and Placement

*Skip this step if you only purchased the F701- DR front camera.

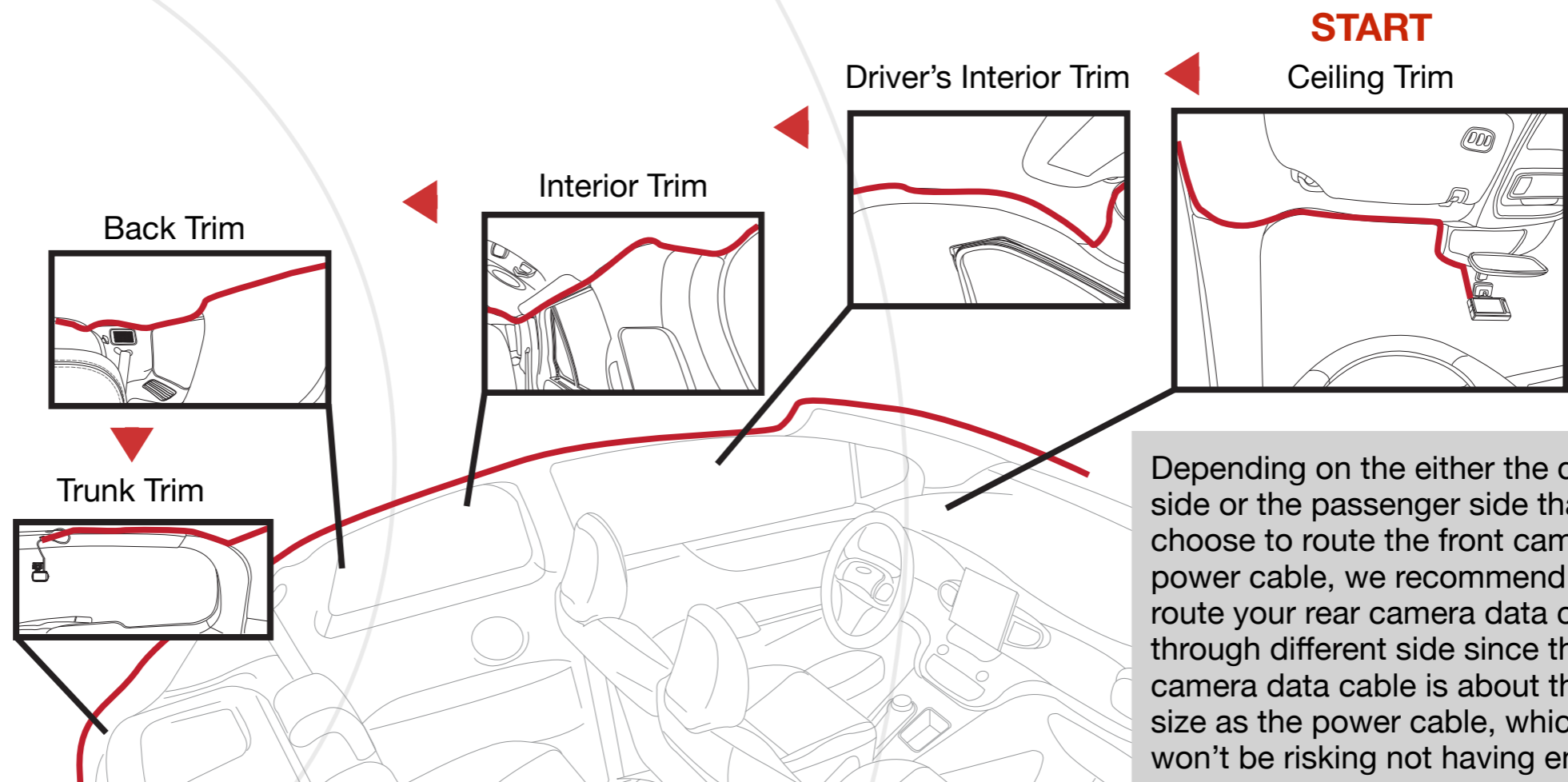
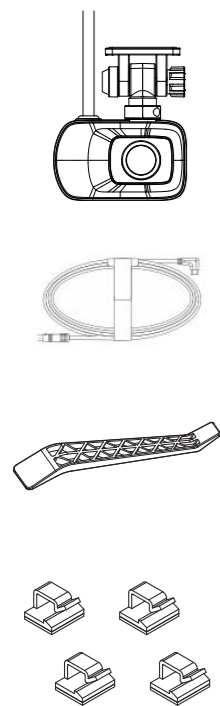

Depending on the either the driver side or the passenger side that you choose to route the front camera power cable, we recommend that you route your rear camera data cable through different side since the rear camera data cable is about the some size as the power cable, which you won't be risking not having enough space between vehicle body and interior trim and weather stripping.

- ▶ Connect the rear camera USB-C Extension Cable to the front camera.
- ▶ Place the rear camera wire in between the vehicle body and the vehicle interior trim by using the cable tucker tool provided from the installation kit.



4

Installation

4.2 F201-IR Rear Camera Installation

4.2.4 Rear Camera Wiring Route and Placement for SUVs

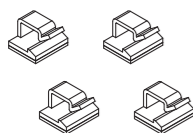
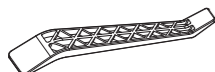
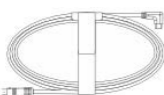
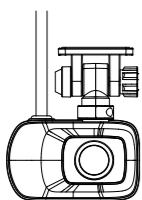

***Skip this step if you only purchased the F701- DR front camera.**

****SUV's or Vehicles with Tailgate Trunks Only**

If needed, set the cable clip on top of the rear deck to clip and hold the cable.

For SUVs, position the rear camera wire between the vehicle ceiling and trunk door. This will account for the extended distance between the ceiling and trunk when the trunk door is fully opened.

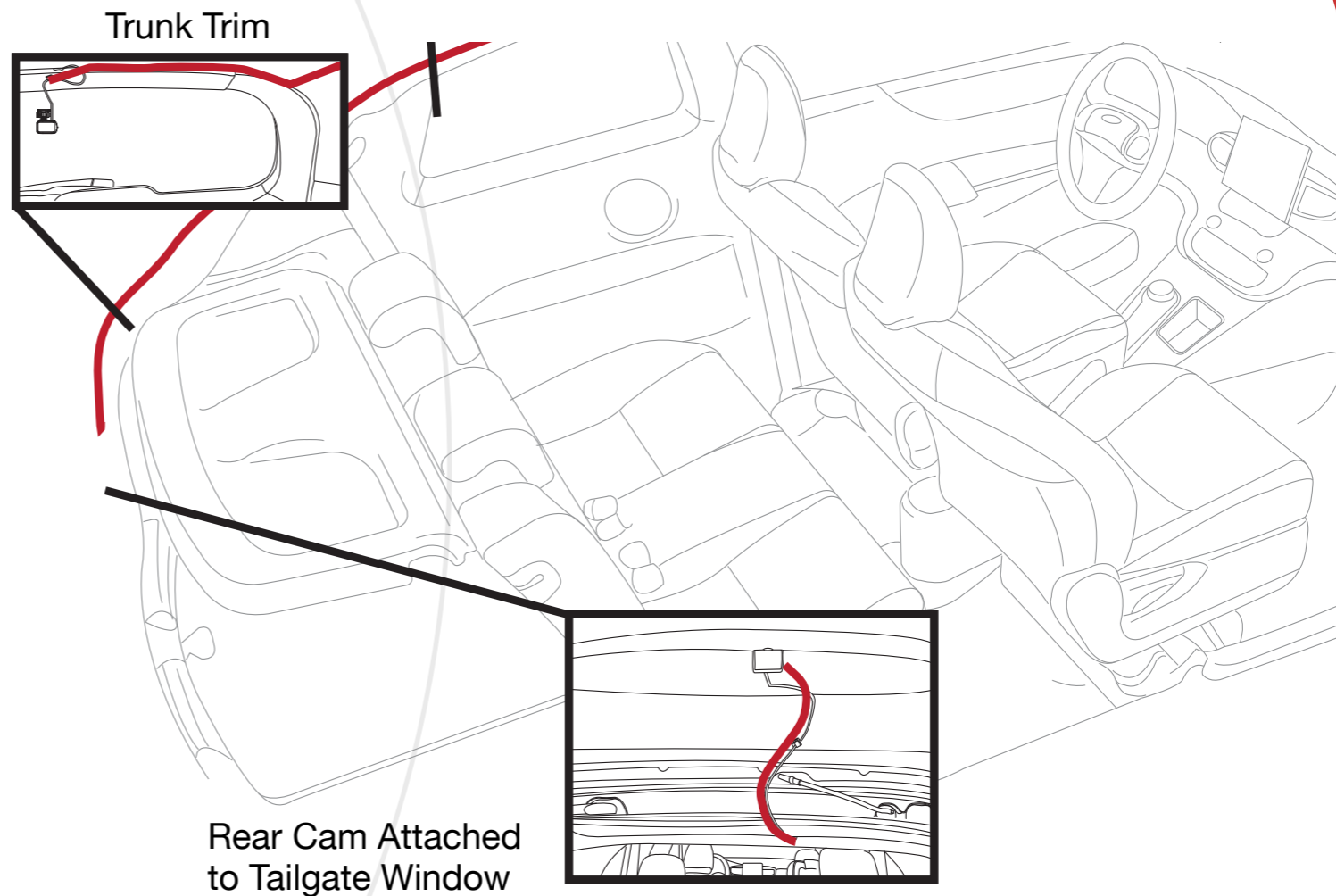

- ▶ Leave out enough cable that allows the rear cam stays connected without putting any tension on the cable when opening and closing the tailgate.

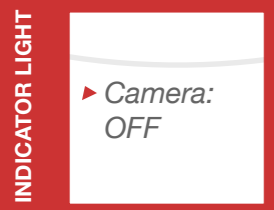

FAS-CAM

4

Installation

4.3 Power-On

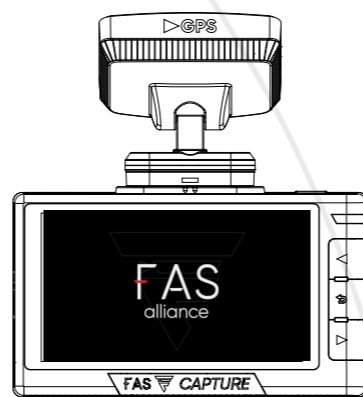
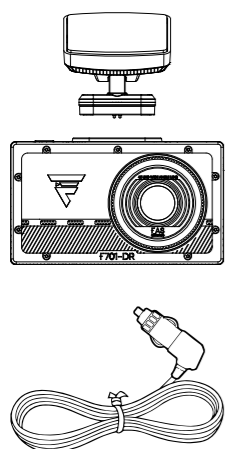

It is recommended to keep a portion of the vehicle engine hood in the front view of the camera.



INDICATOR LIGHT

- ▶ Power: ON
- ▶ Recording: WHITE - ON

- ▶ Power-on the front camera by starting the vehicle ignition.
- ▶ View the displayed front view and adjust the front camera to the desired angle.

FAS-CAM

4

Installation

4.3 Power-On

*Skip this step if you only purchased the F701- DR front camera.

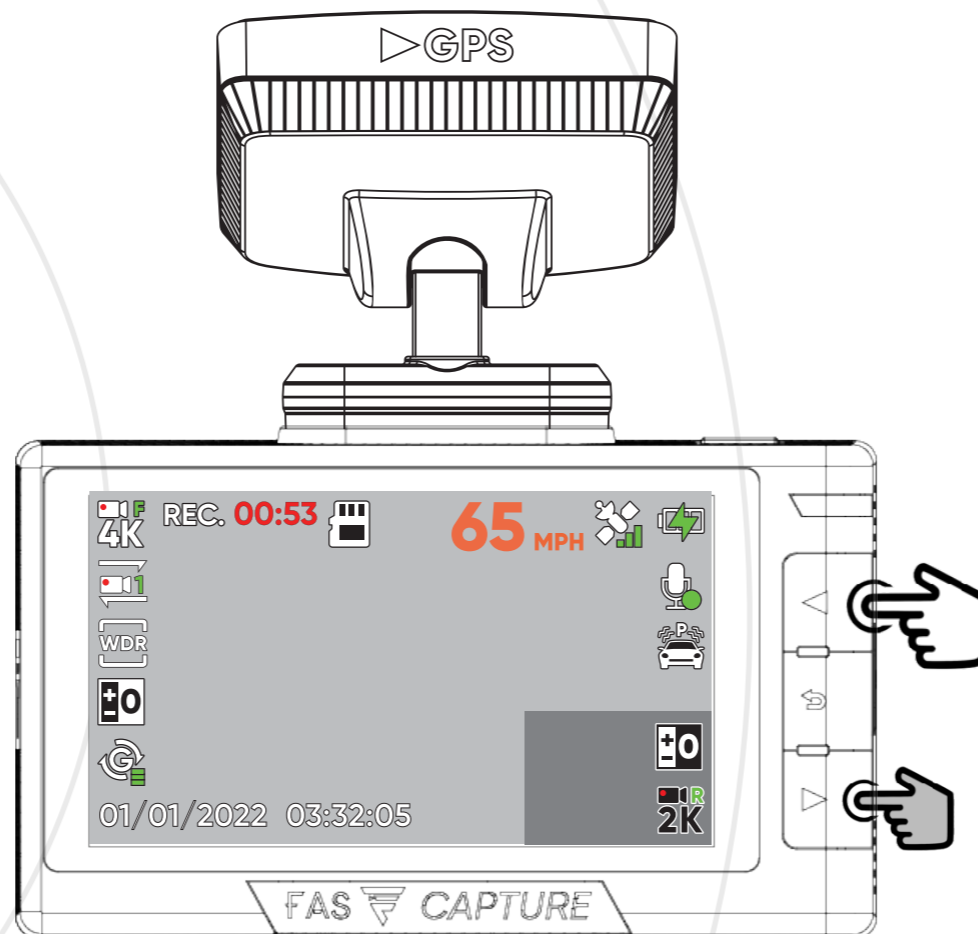
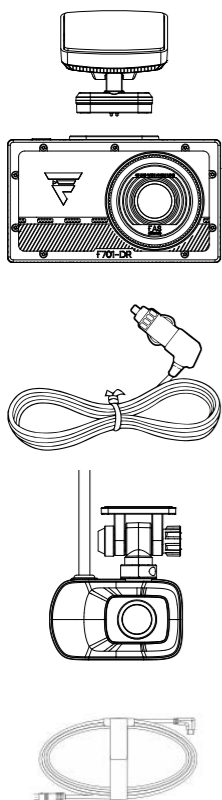

Make sure to close the trunk door before reviewing the displayed rear camera view on the front camera.

Full View Selector

Split View Selector

- ▶ Use the ◀ button to switch the displayed view to “Rear View”.
- ▶ View the displayed rear view and adjust the rear camera to the desired angle.
- ▶ Use the ◀ or ▶ button to switch between views.

INDICATOR LIGHT

- ▶ Power: ON
- ▶ Recording: WHITE - ON

FAS-CAM

5 FAS-CAPTURE / FAS-MODE

5.1 FAS-CAPTURE

FAS-CAPTURE **Instant**



Press once

To use: Press FAS-CAPTURE once to screenshot and protect your current recording. Users will hear a camera shutter sound.

Files being protected: Screenshot photo during click & protect the *previous*, *current*, and *next* loop recording clips.

Protected Videos will be under
Menu ▶ Files ▶ Protected

Screenshot Photos will be under
Menu ▶ Files ▶ Photos

FAS-CAPTURE will capture your desired image in place so you don't need to rewind your videos to search for important info. It protects and locks previous, current, and next loop recording clips from being accidentally overwritten.

Indicator Light

- ▶ Power: ON
- ▶ Recording: RED - ON (while recording during protected mode)

5 FAS-CAPTURE / FAS-MODE

5.2 FAS-MODE

FAS-MODE Continuous



Press and hold

To use: Click FAS-CAPTURE button three times OR press and hold for 5 seconds. A red frame will appear on the screen.

To exit: Press and hold the return button for 5 seconds.

Files being protected: previous and current (until manual exit) loop videos

Protected Videos will be under
Menu ▶ Files ▶ Protected

FAS-MODE will continuously record the scenes on the road in protected mode until you exit FAS-MODE. This feature gives you peace of mind in the event of an emergency so you won't have to worry about losing important footage.

Indicator Light

- ▶ Power: ON
- ▶ Recording: RED - ON (while recording during protected mode)

5 FAS-CAPTURE / FAS-MODE

5.2 FAS-MODE

5.2.1 When to Use

USE FAS-MODE TO PROTECT YOUR FILES

Activate FAS-MODE to protect video files from being overwritten and to continue recording when emergencies occur.

FAS-MODE ensures strong evidence is preserved for police investigations and insurance claims if you encounter emergencies, accidents, collisions, etc.

Indicator Light

- ▶ Power: ON
- ▶ Recording: RED - ON (while recording during protected mode)

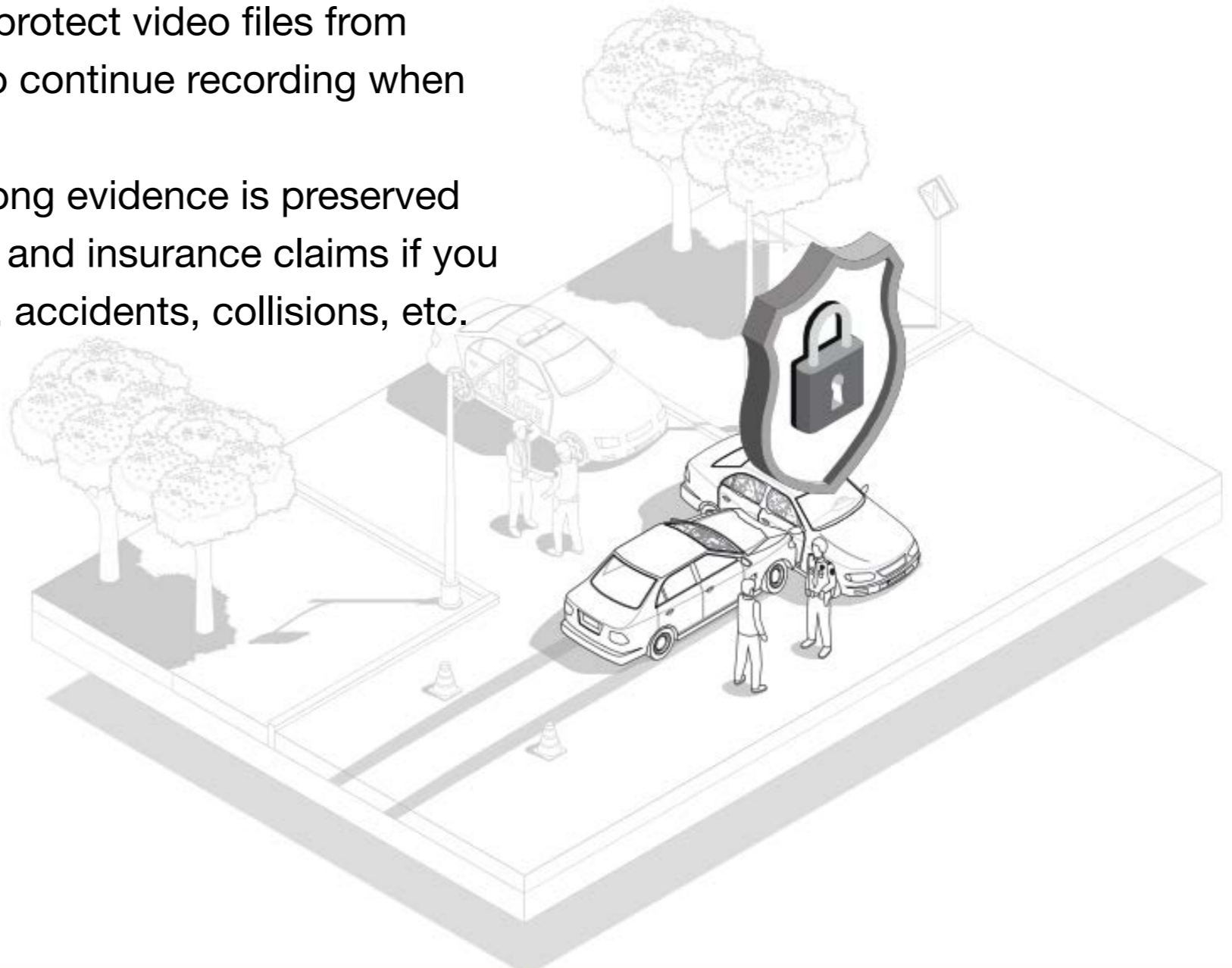

5 FAS-CAPTURE / FAS-MODE

5.2 FAS-MODE

▶ 5.2.1 When to Use

USE FAS-MODE TO CONTINUOUSLY RECORD WHEN THE ENGINE IS OFF

Activate FAS-MODE to continue to record videos using the camera's internal battery. The camera can detach from the vehicle for handheld use to record wherever the evidence is located.

Indicator Light

- ▶ Power: ON
- ▶ Recording: RED - ON (while recording during protected mode)



5 FAS-CAPTURE / FAS-MODE

5.2 FAS-MODE

5.2.1 When to Use

USE FAS-MODE TO RECORD VIDEOS WHEN YOUR PHONE IS UNAVAILABLE

Use FAS-MODE if you need to record videos of the accident while using your cell phone to call emergency responders.

FAS-MODE will continue to record events while the driver can get out of the car to check on the actual situation or call for help.

Indicator Light

- ▶ Power: ON
- ▶ Recording: RED - ON (while recording during protected mode)

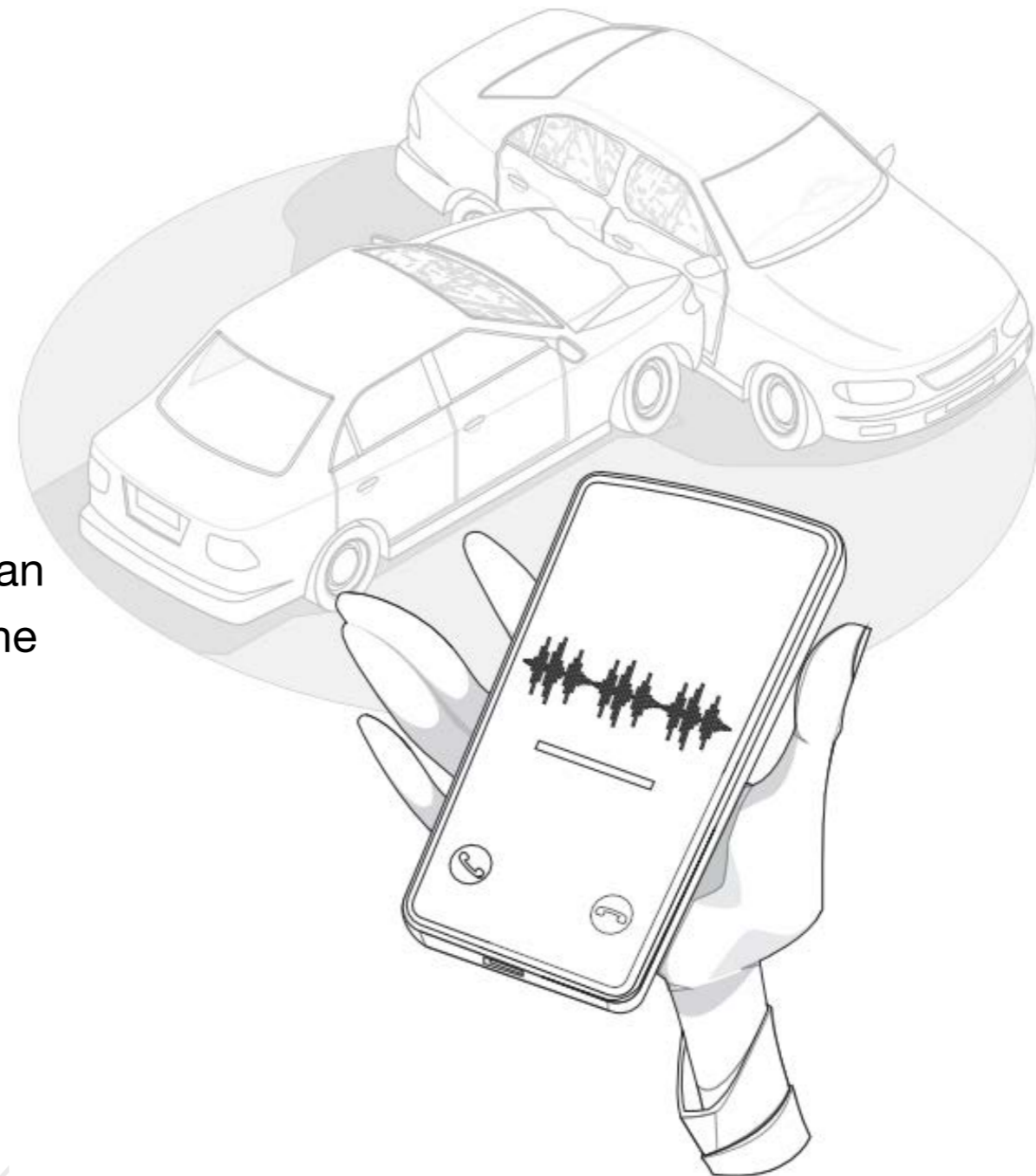

How to Read Side Bar

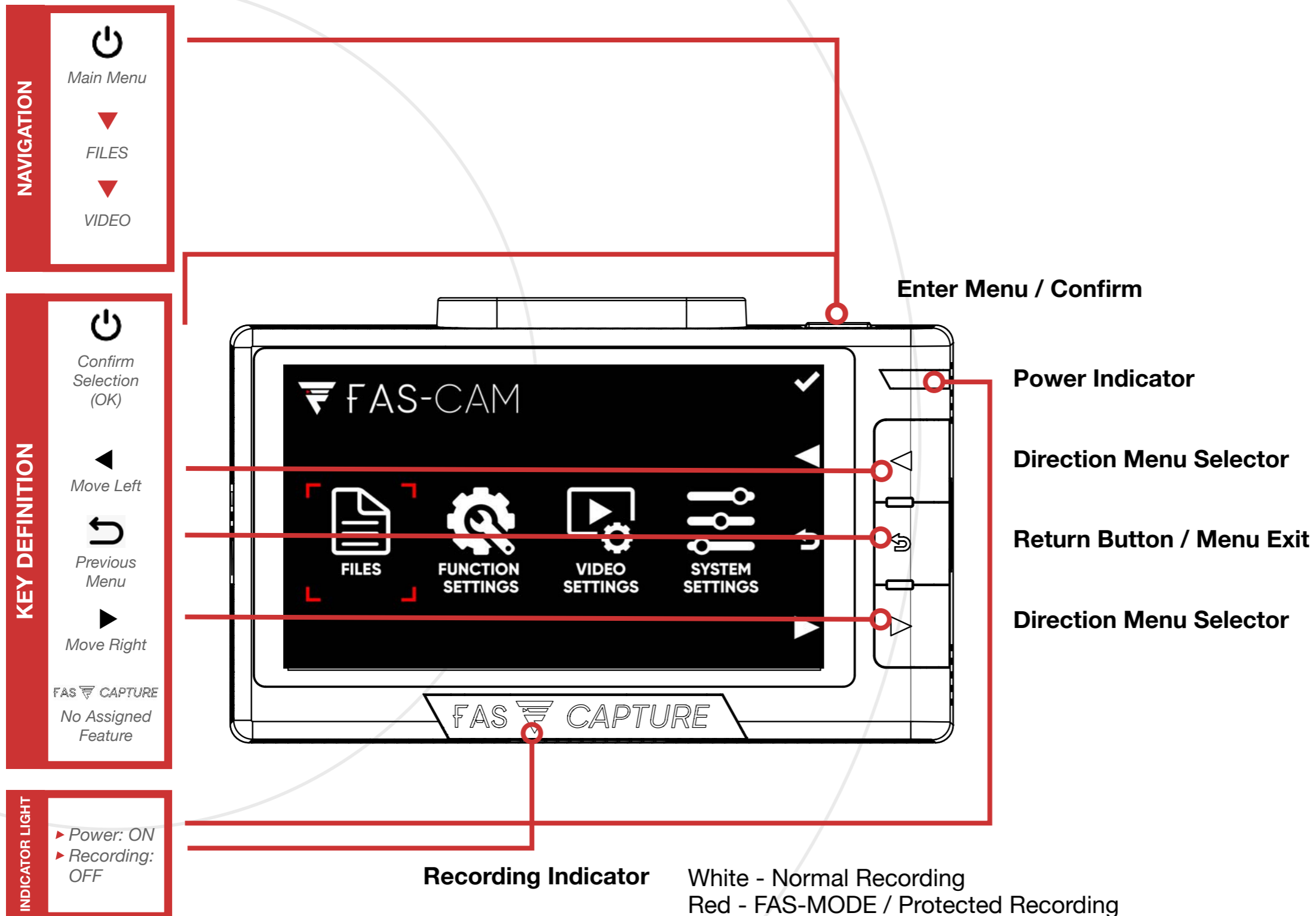

Recording Indicator White - Normal Recording
Red - FAS-MODE / Protected Recording

6

Operation

6.1 Recording

6.1.1 Power-on and Start Recording

NAVIGATION

- Power icon: Main Menu
- Down arrow icon: FILES

KEY DEFINITION

- Power icon: Confirm Selection (OK)
- Left arrow icon: Move Left
- Right arrow icon: Move Right
- Up arrow icon: Previous Menu
- Down arrow icon: No Assigned Feature

INDICATOR LIGHT

- ▶ Power: ON
- ▶ Recording: WHITE - ON

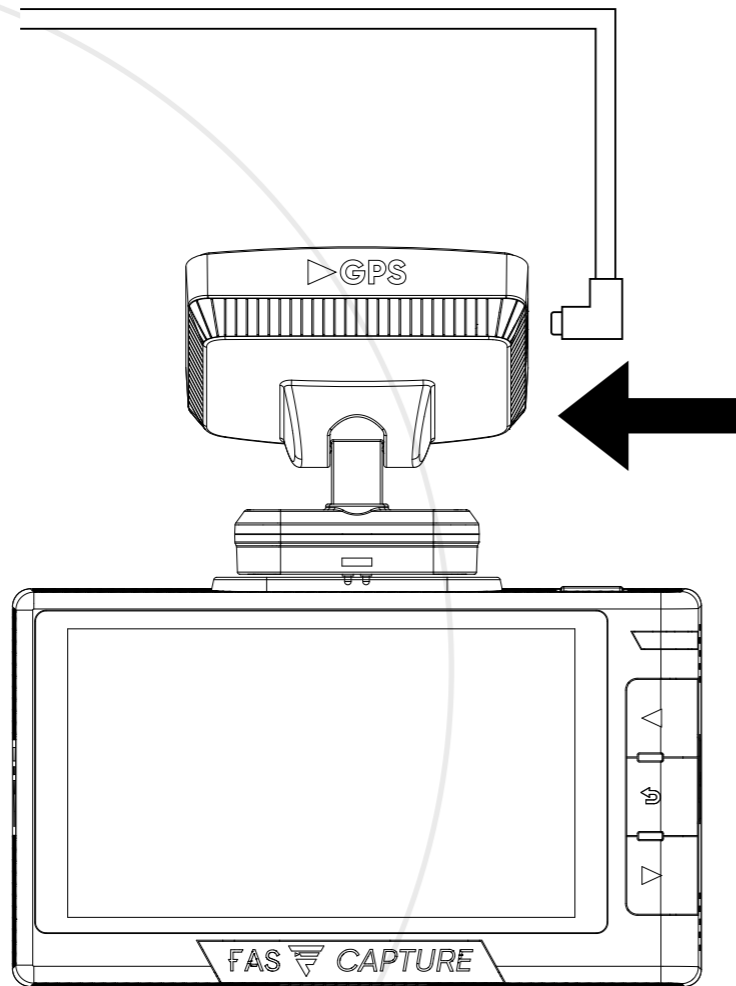

- ▶ Connect the power cable to the camera and the car's power source.
- ▶ Start the engine.
- ▶ Device will turn on automatically after a few 5 seconds.

Startup View



Recording View

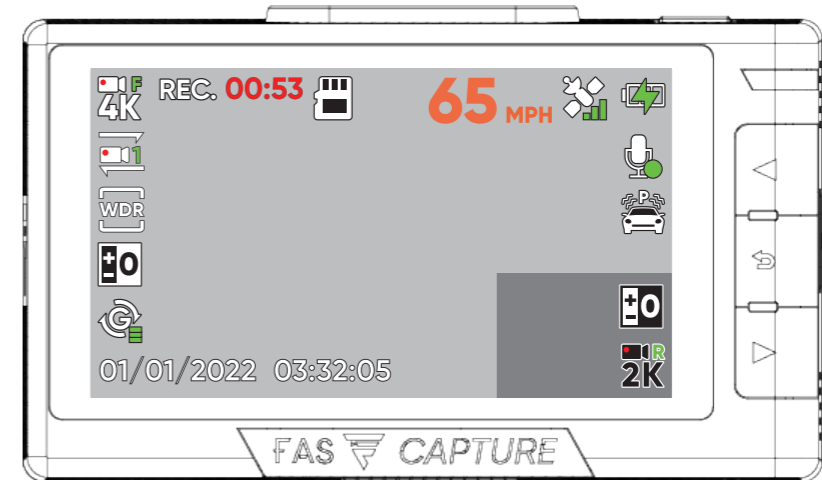

- ▶ Format the TF Card before your first use.
- ▶ Rear view camera will NOT turn on if there is no external power source
- ▶ Never take out TF Card (SD Card) when recording

6

Operation

6.2 Playback



6.2.1 Browse File

FUNCTION DEFINITION

To playback past video recording on the camera. To playback on the computer see Chapter "**8: Video Playback App**"

NAVIGATION



Main Menu



FILES

KEY DEFINITION



Confirm Selection (OK)



Move Left



Previous Menu



Move Right

FAS CAPTURE

No Assigned Feature

INDICATOR LIGHT

- ▶ Power: ON
- ▶ Recording: OFF

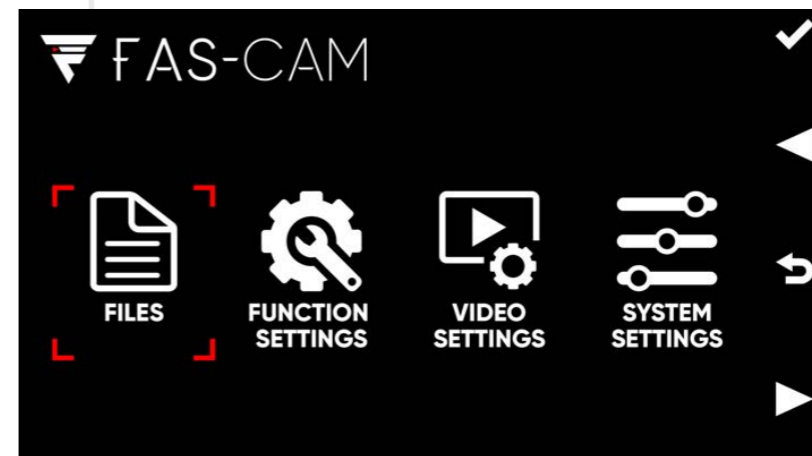
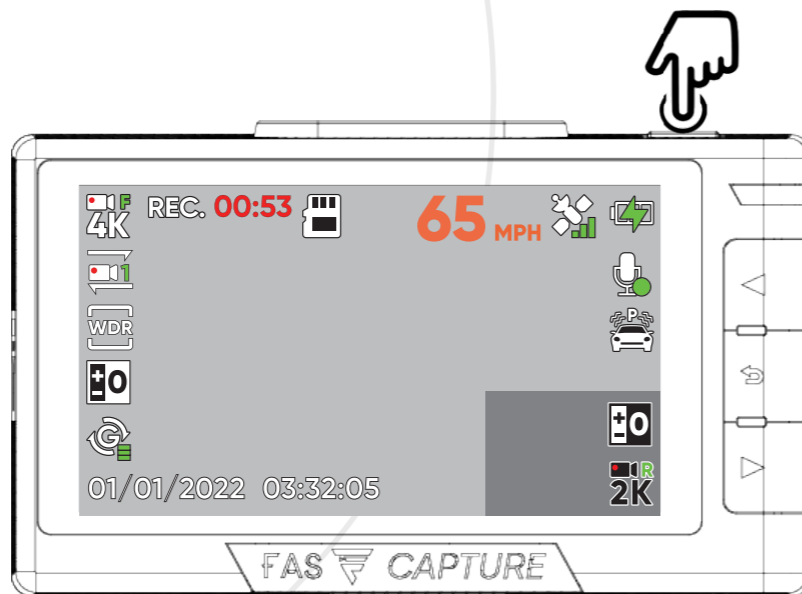

6

Operation

6.2 Playback

6.2.1 Browse File

NAVIGATION

 Main Menu

 FILES

 VIDEO / PHOTO

KEY DEFINITION

 Confirm Selection (OK)

 Move Left

 Previous Menu

 Move Right
 FAS  CAPTURE
 DELETE

INDICATOR LIGHT

▶ Power: ON
 ▶ Recording: OFF

FILE TYPE

Key	Function / Description
VIDEO	MOV video file
PROTECTED	Protected MOV video file
PHOTO	JPG image file

Browse VIDEO or PHOTO

▶ Play / View

Select a video, and press  key to enter player (see [6.2.3 Play and Pause](#) video to continue with this option)

▶ Delete

Select a designated video or photo to delete directly by press **FAS  CAPTURE** key (see [next page](#) to continue with this option)

Note: Photos are taken via [FAS-CAPTURE](#)

FILE NAME

	Date	Time	View source
Example	220603	144437	F / R
Format	YYMMDD	HHMMSS	Front / Rear

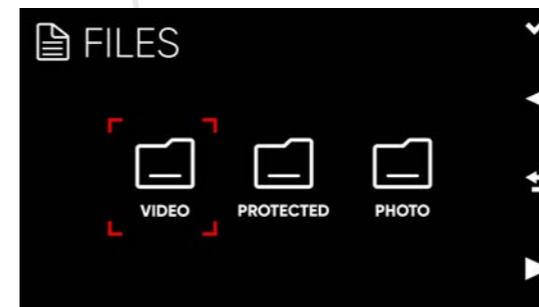

Or

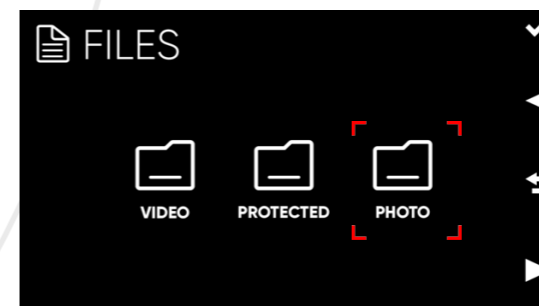

6

Operation

6.2 Playback



6.2.2 Delete Files

NAVIGATION

- Power icon
Main Menu
- Down arrow
FILES
- Down arrow
VIDEO / PHOTO

KEY DEFINITION

- Power icon
Confirm Selection (OK)
- Left arrow
Move Left
- Up arrow
Previous Menu
- Right arrow
Move Right
- FAS CAPTURE
DELETE

INDICATOR LIGHT

- ▶ Power: ON
- ▶ Recording: OFF



FAS CAPTURE

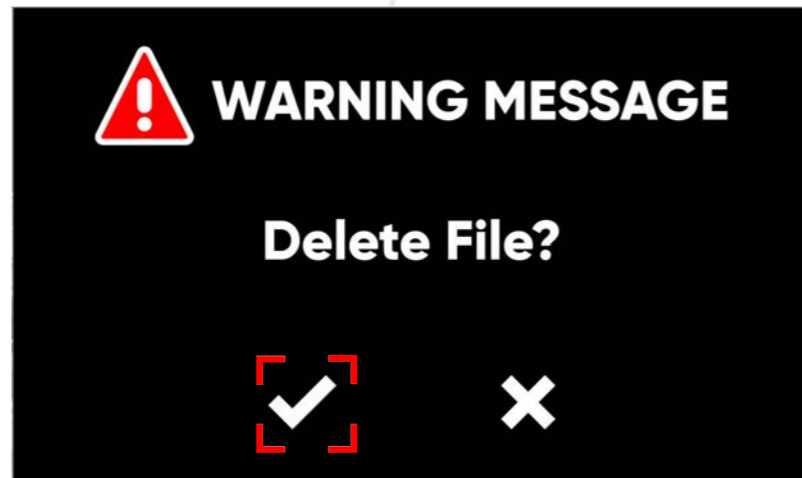

- ▶ In “VIDEO” or “PHOTO” folder, press FAS CAPTURE to delete the selected video
- ▶ “WARNING MESSAGE Delete File?” option:
 1. Select option, and press Power key to confirm
 2. or select option, and press Power key to exit

6

Operation

6.2 Playback



6.2.3 Play and Pause File

NAVIGATION

Power icon
Main Menu

▼
FILES

▼
VIDEO



KEY DEFINITION

Power icon
Confirm Selection (OK) / PLAY / PAUSE

◀
Move Left

↶
Previous Menu

▶
Move Right

FAS CAPTURE
DELETE

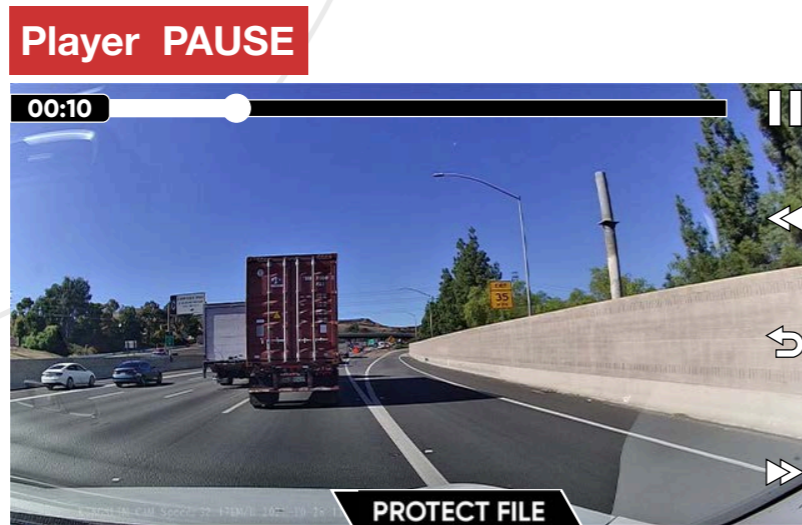
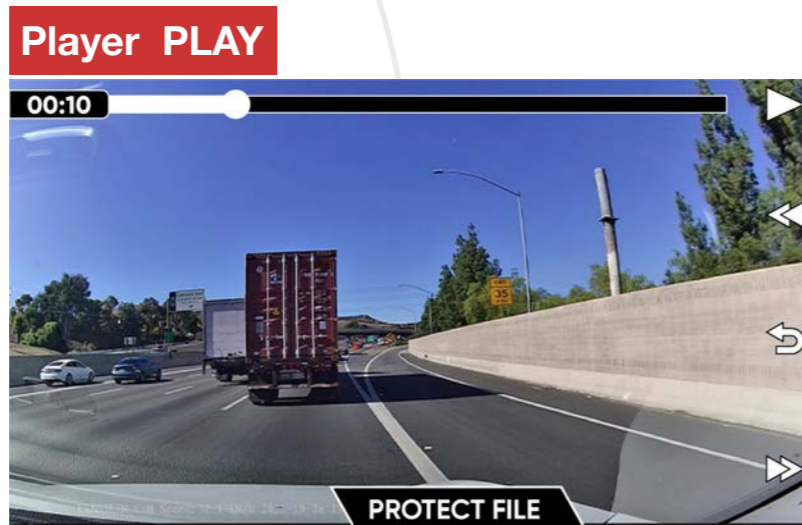

INDICATOR LIGHT

- ▶ Power: ON
- ▶ Recording: OFF

- ▶ In “VIDEO” folder, select a video and press key to enter player
- ▶ Press key to **PLAY** current video
- ▶ Press key again to **PAUSE** the video
- ▶ **Exit Player**
Press key to exit file player
- ▶ **Protect File**
Press key to “PROTECT FILE” (see next page to continue with this option)

6

Operation

6.2 Playback

6.2.4 Protect and Unprotect File

6.2.4.1 Protect File

NAVIGATION



Main Menu



FILES



VIDEO

KEY DEFINITION



Confirm Selection (OK) / PLAY / PAUSE



Move Left



Previous Menu



Move Right

FAS CAPTURE

PROTECT FILE

INDICATOR LIGHT

- ▶ Power: ON
- ▶ Recording: OFF

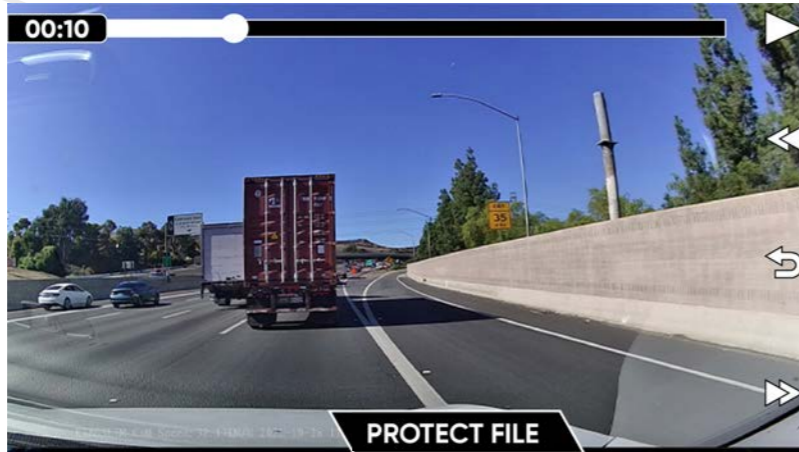

FAS CAPTURE



Protect File

- ▶ Press FAS CAPTURE key to “**PROTECT FILE**”
- ▶ Warning Message: “FILE PROTECTION Protect or Unprotect File?”
 1. Select option, and press key to “**PROTECT FILE**” on Warning Message window. Then, this file will be moved into “**PROTECTED**” folder
 2. Select option, and press key to exit.

6

Operation

6.2 Playback

6.2.4 Protect and Unprotect File

6.2.4.2 Unprotect File

NAVIGATION



FAS CAPTURE

KEY DEFINITION



INDICATOR LIGHT

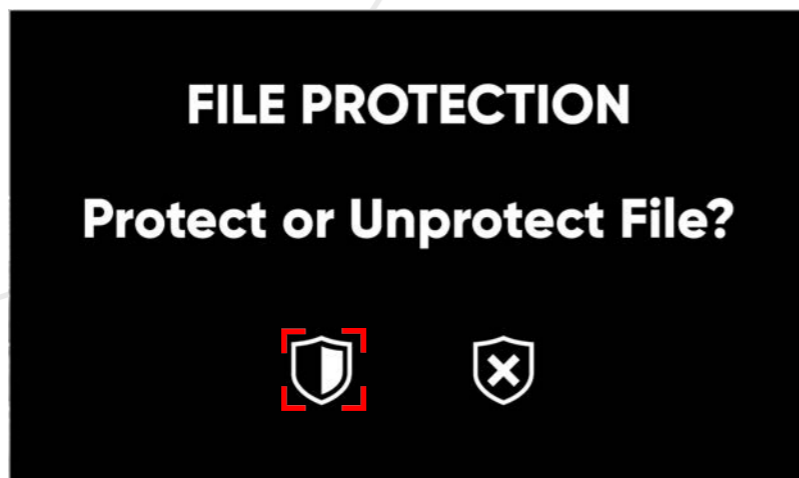

- ▶ In “FILES” menu, select “**PROTECTED**” folder, and press key to confirm the selection
- ▶ **Unprotect File**
 1. Press key
 2. Warning Message: “FILE PROTECTION Protect or Unprotect File?”
 - ▶ Select option to “**PROTECT FILE**”
 - ▶ Select option to “**UNPROTECT FILE**”
- ▶ **Play Video**

Press key to enter player (see next page to continue with this option)

6

Operation

6.2 Playback

6.2.4 Protect and Unprotect File

6.2.4.2 Unprotect File

NAVIGATION



KEY DEFINITION



INDICATOR LIGHT

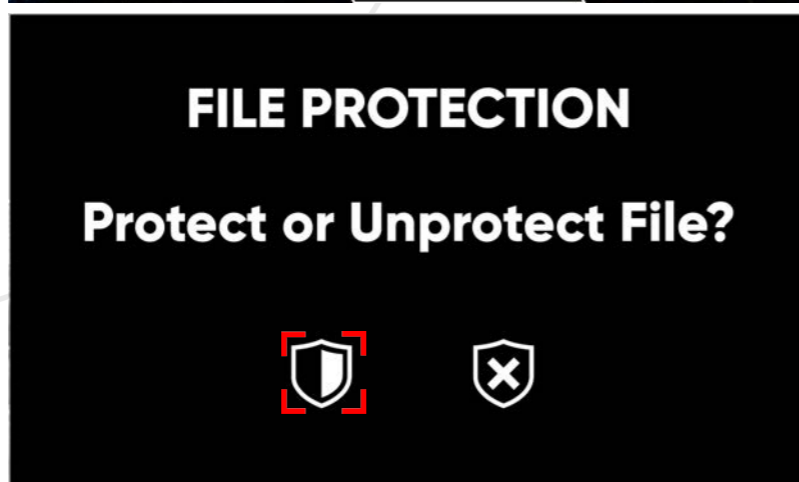

- ▶ After enter the player, press key to play or pause current file

Unprotect File During Video Playback

1. Press key
2. Warning Message: “FILE PROTECTION Protect or Unprotect File?”
 - ▶ Select option to “**PROTECT FILE**”
 - ▶ Select option to “**UNPROTECT FILE**”

7

Settings

Menu Display Overview

NAVIGATION



Main Menu

KEY DEFINITION



Confirm Selection (OK)



Move Left



Previous Menu



Move Right

FAS CAPTURE

No Assigned Feature

INDICATOR LIGHT

- ▶ Power: ON
- ▶ Recording: OFF

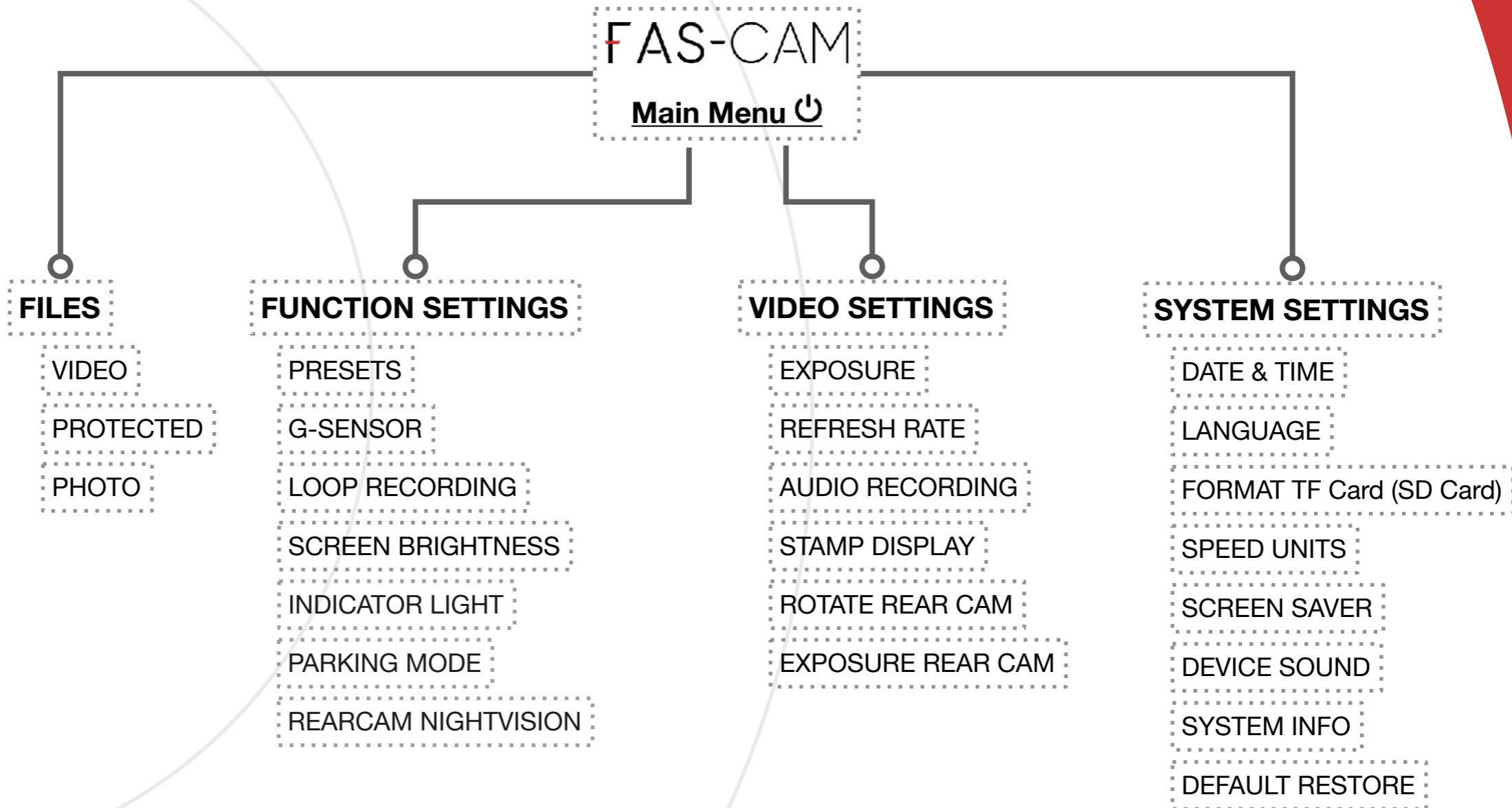

System will not be recording when in the menu.
System will not activate SCREEN SAVER when in the menu

7

Settings

NAVIGATION



Main Menu

KEY DEFINITION



Confirm Selection (OK)



Move Left



Previous Menu



Move Right

FAS CAPTURE
No Assigned Feature

INDICATOR LIGHT

- ▶ Power: ON
- ▶ Recording: OFF

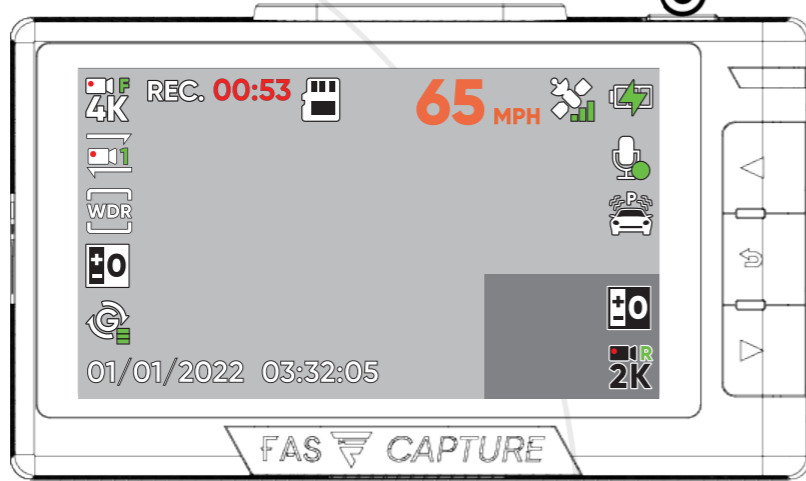

Enter Main Menu

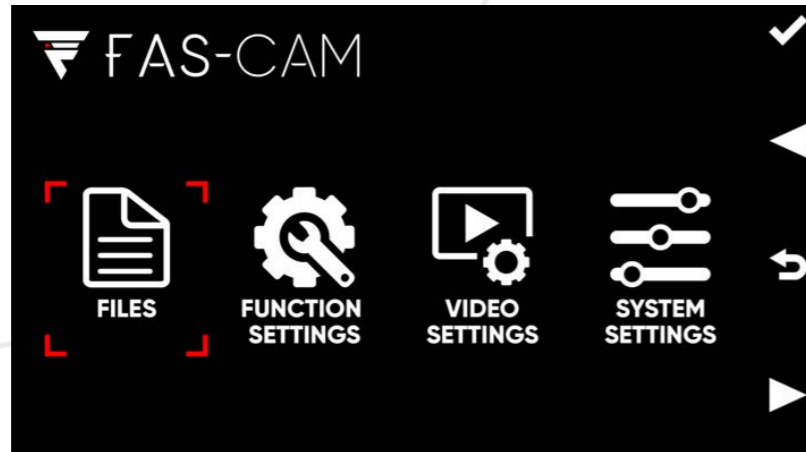

FUNCTION SETTINGS

- PRESETS** easy preset setup ULTIMATE, STANDARD, SPORTS, ECO
- G-SENSOR** adjust impact detection/video lock LOW, MED, HIGH, OFF
- LOOP RECORDING** set video recording length before overwriting 1,2,3 MIN
- SCREEN BRIGHTNESS** adjust intensity of screen light AUTO, NORMAL, SUNNY
- INDICATOR LIGHT** set indication light ON, OFF
- PARKING MODE** ACC wire connection required MOTION, G-SENSOR
- REARCAM NIGHTVISION** activate cabin view AUTO, ON, OFF

VIDEO SETTINGS

- EXPOSURE** adjust brightness of video files -3, -2, -1, 0, 1, 2, 3
- REFRESH RATE** adjust speed of video display 50 HZ, 60 HZ
- AUDIO RECORDING** adjust audio on video recordings ON, OFF
- STAMP DISPLAY** select info display DATE & TIME, GPS LOCATION, SPEED
- ROTATE REAR CAM** adjust video display STANDARD, 180 DEGREE
- EXPOSURE REAR CAM** adjust brightness of rear cam -3, -2, -1, 0, 1, 2, 3

SYSTEM SETTINGS

- DATE & TIME** easy date and time setup TIME ZONE, DAYLIGHT SAVINGS, AUTO
- LANGUAGE** ui language settings ENGLISH, SPANISH, FRENCH, CHINESE
- SPEED UNITS** easy unit conversion KM, MI
- SCREEN SAVER** set screen blackout time 1 MIN, 3 MIN, 5 MIN, OFF

7

Settings

7.1 Function Settings

7.1.1 Presets

NAVIGATION



KEY DEFINITION

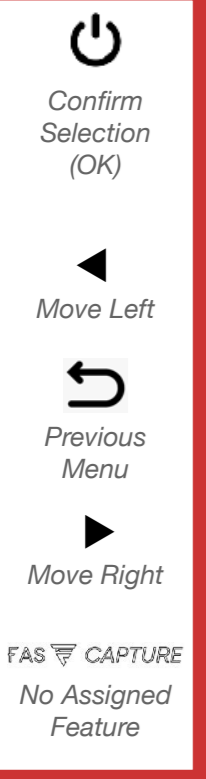

INDICATOR LIGHT



FUNCTION DEFINITION

The only dash cam on the market to offer presets for easy user setup. Using Presets will overwrite any custom settings. You can easily change your settings for a more personalized user experience.

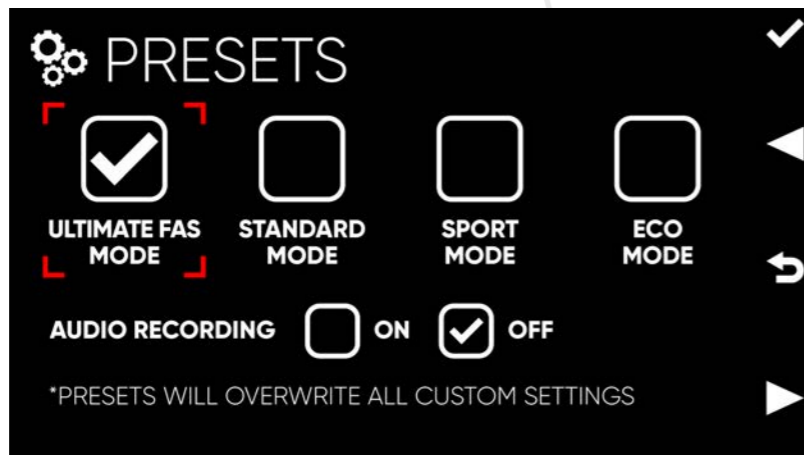

FUNCTION OPTIONS

- ▶ **ULTIMATE FAS**
- ▶ **STANDARD**
- ▶ **SPORT**
- ▶ **ECO**
- ▶ **AUDIO RECORDING**
ON / OFF audio in video playback
“AUDIO RECORDING” option can also be set at [7.2.3 Audio Recording](#)
- ▶ **Default Setting**
ECO MODE / AUDIO: OFF
We recommend selecting “Standard Mode” during initial setup.

	ULTIMATE FAS BEST USER EXPERIENCE	STANDARD BASIC USAGE	SPORT ON THE GO	ECO MAX MEMORY & POWER SAVING
LOOP RECORDING	3 MIN	3 MIN	2 MIN	1 MIN
G-SENSOR	MED	LOW	OFF	OFF
PARKING MODE	ON	ON	OFF	OFF
AUDIO RECORDING	OFF	OFF	ON	OFF
STAMP DISPLAY	ON	ON	ON	OFF
SCREEN SAVER	OFF	3 MIN	OFF	1 MIN

7

Settings

7.1 Function Settings

7.1.2 G-Sensor

NAVIGATION



KEY DEFINITION

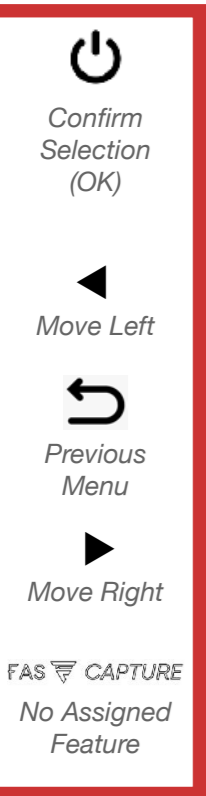

INDICATOR LIGHT



FUNCTION DEFINITION

To detect a sudden change while driving, and video footage will be automatically saved as a PROTECTED non-overwritable clip. This setting does not affect the Parking Mode's G-Sensor.

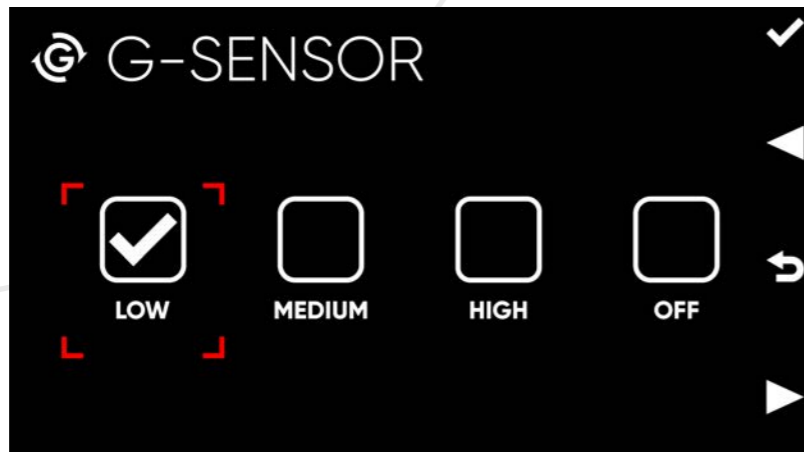
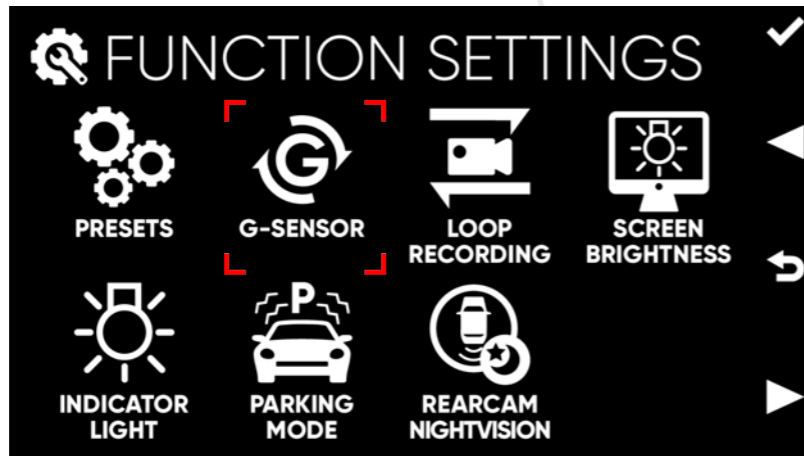

FUNCTION OPTIONS

- ▶ Select a preferred sensitivity level from “LOW”, “MEDIUM”, “HIGH”, and “OFF”.
- ▶ **Default Setting**
Depending on Preset Selection

Event	LOW	MEDIUM	HIGH
Light Accident / Crash	Triggered	Triggered	Triggered
Rough Road	NOT Triggered	Triggered	Triggered
Close Door or Tailgate	NOT Triggered	NOT Triggered	Triggered

7

Settings

7.1 Function Settings

7.1.3 Loop Recording

NAVIGATION



KEY DEFINITION



INDICATOR LIGHT



FUNCTION DEFINITION

To control video clip time length when the file is saved or overwritten. Loop Recording automatically overwrites the oldest UNLOCKED file when your TF card is full. Remove the hassle of manually deleting unnecessary videos.

FUNCTION OPTIONS

- ▶ Select a preferred video clip time length from “1 MIN”, “2 MIN”, and “3 MIN”.
- ▶ **Default Setting**
Depending on Preset Selection

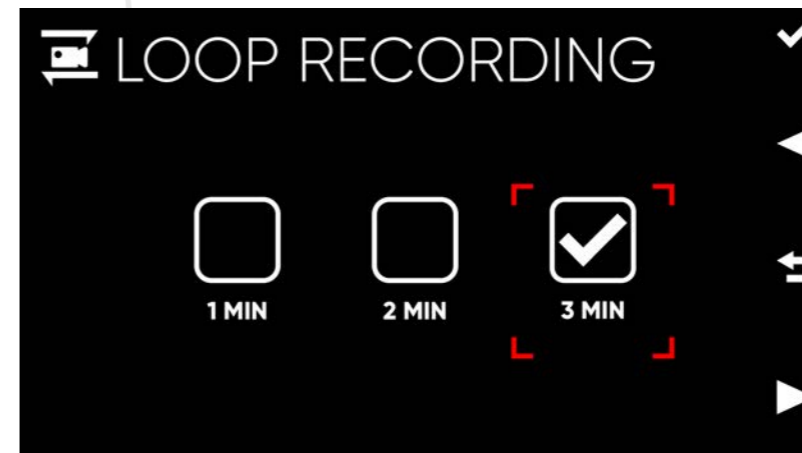
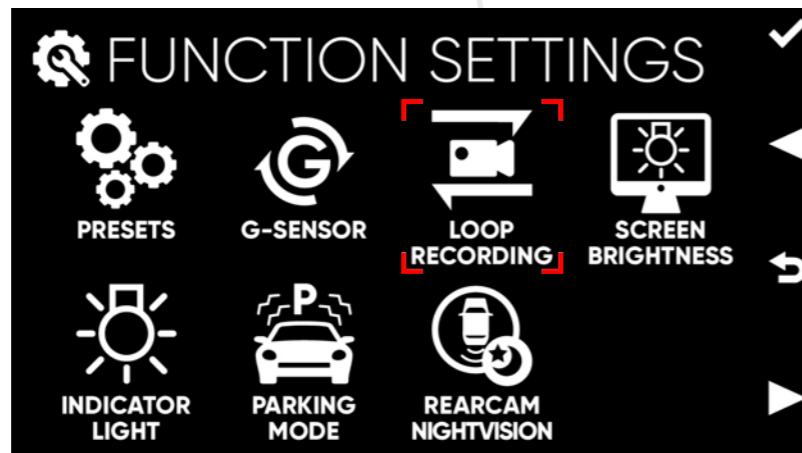

7

Settings

7.1 Function Settings

7.1.4 Screen Brightness

NAVIGATION



KEY DEFINITION



INDICATOR LIGHT

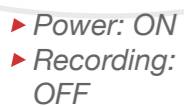

FUNCTION DEFINITION

To adjust the brightness level of the camera's display screen

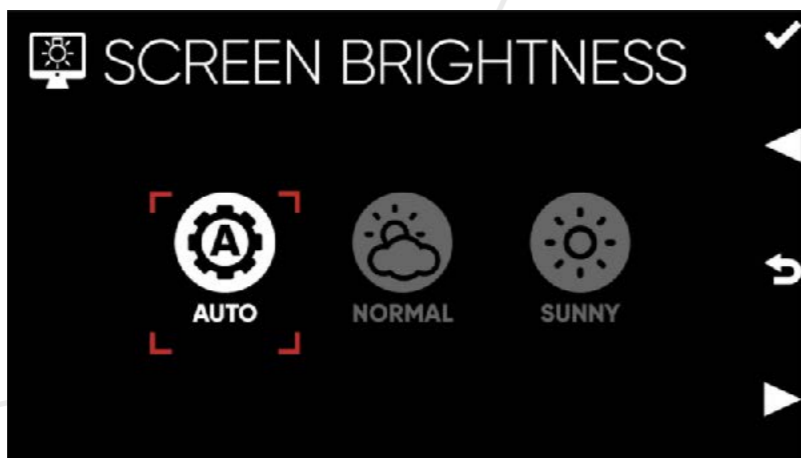
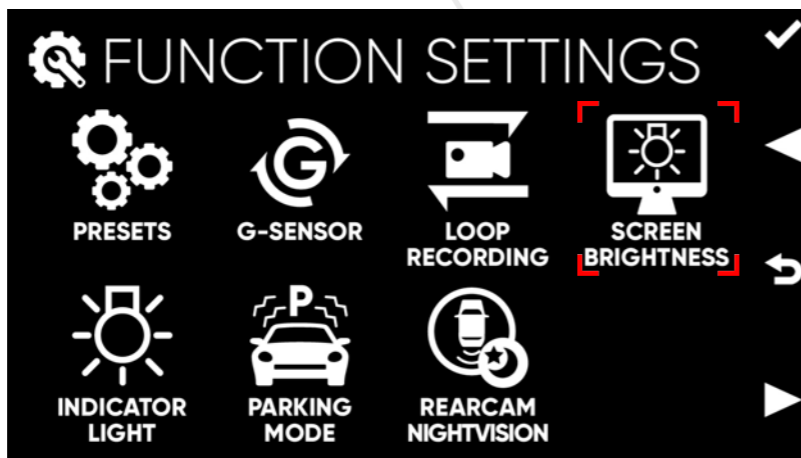

FUNCTION OPTIONS

- ▶ **AUTO**
Screen will adjust according to the recording environment
- ▶ **NORMAL**
Screen brightness will be standard
- ▶ **SUNNY**
Screen brightness will be dimmer than normal
- ▶ **Default Setting**
AUTO

7

Settings

7.1 Function Settings

7.1.5 Indicator Light

NAVIGATION



Main Menu



FUNCTION
SETTINGS



INDICATOR
LIGHT

KEY DEFINITION



Confirm
Selection
(OK)



Move Left



Previous
Menu



Move Right

FAS CAPTURE

No Assigned
Feature

INDICATOR LIGHT

- ▶ Power: ON
- ▶ Recording: OFF

FUNCTION DEFINITION

When the indicator light is switched on, the light will be RED whenever the camera is receiving power.

FUNCTION OPTIONS

- ▶ **ON**
to have the indicator light be on when the camera is receiving power
- ▶ **OFF**
to record videos without the Indicator Light
- ▶ **Default Setting**
ON

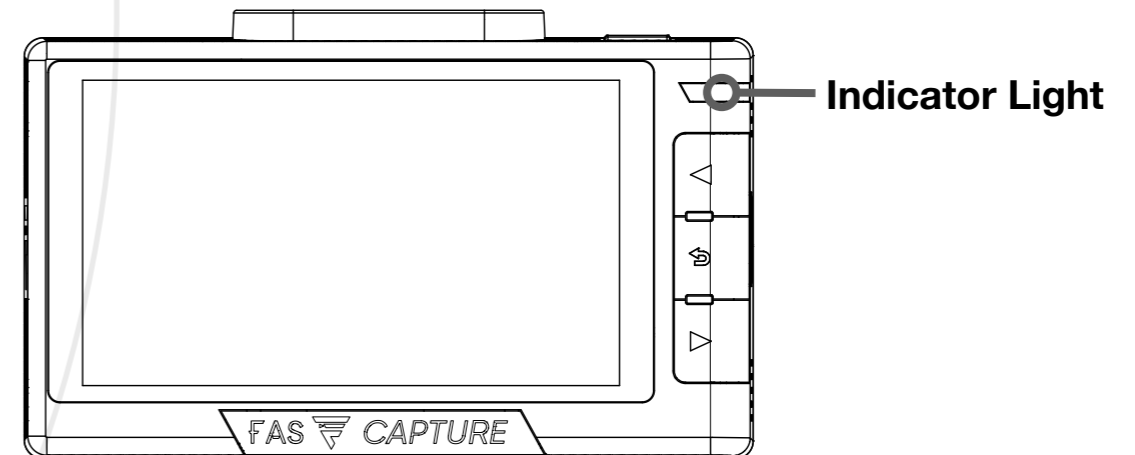
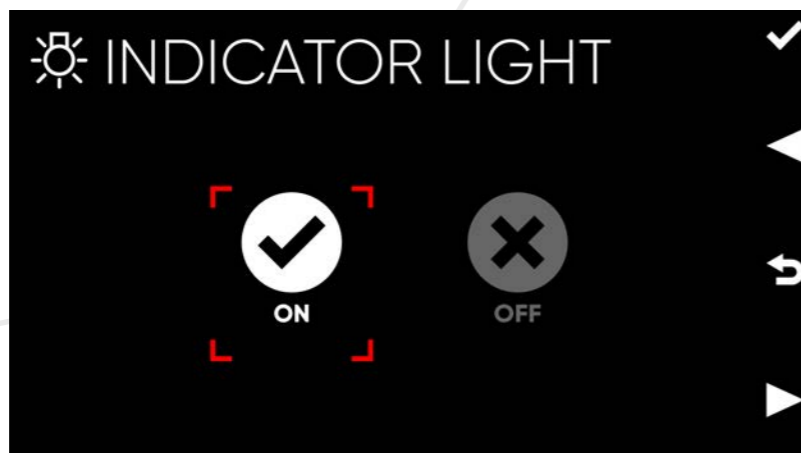
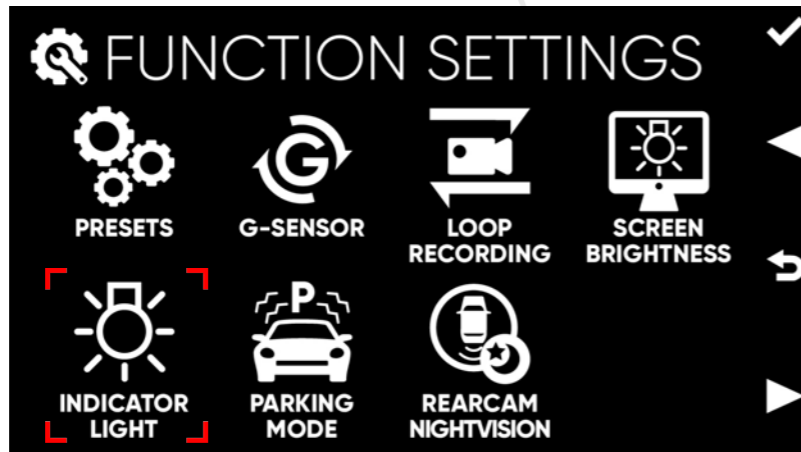

7

Settings

7.1 Function Settings

7.1.6 Parking Mode

NAVIGATION



KEY DEFINITION



INDICATOR LIGHT



FUNCTION DEFINITION

Parking mode allows you to record from your vehicle while your car is parked and your engine is off. The FAS-CAM automatically switches to parking mode when necessary, removing the hassle of manually switching your dash cam's mode before leaving your vehicle.

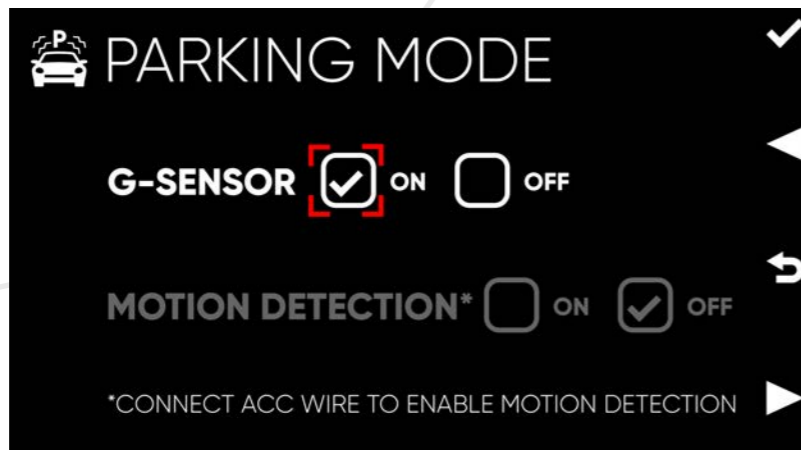
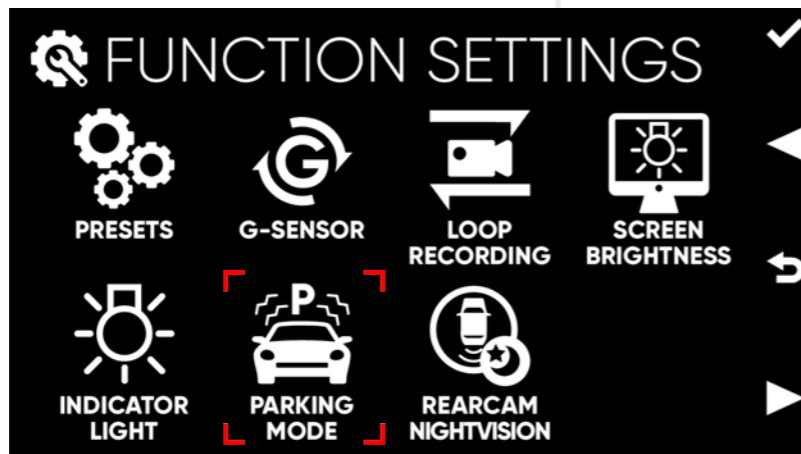

FUNCTION OPTIONS

▶ G-SENSOR

ON: to enable parking mode with impact detection

OFF: disable parking mode with impact detection

▶ MOTION DETECTION*

ON: enable parking mode with motion detection

OFF: disable parking mode with motion detection

* It is required to "CONNECT ACC WIRE TO ENABLE MOTION DETECTION"

* ACC Wire is sold separately

▶ Default Setting

Depending on Preset Selection

7

Settings

7.1 Function Settings

7.1.6 Parking Mode

Parking Mode - Function Details

** Rear cam will not be activated during parking mode.

The **activation time** (from the point when the G-Sensor or Motion Sensor is triggered to going into recording):

- ▶ Connected with ACC wire: within 1 sec.
- ▶ Using the camera's internal battery: within 8 sec.

NAVIGATION



Main Menu



FUNCTION SETTINGS



PARKING MODE

KEY DEFINITION



Confirm Selection (OK)



Move Left



Previous Menu



Move Right

FAS CAPTURE

No Assigned Feature

INDICATOR LIGHT

- ▶ Power: ON
- ▶ Recording: OFF

Sample Event	G-Sensor Connected with ACC Wire	Motion-Sensor Connected with ACC Wire	G-Sensor + Motion Sensor Connected with ACC Wire	G-Sensor Camera's Internal Battery	Motion Sensor Camera's Internal Battery
Open or Close Doors or Tailgate	Might be Triggered	Might be Triggered	Might be Triggered	Might be Triggered	NOT Supported
Light Hit from Pedestrian	Triggered	NOT Triggered	Triggered	Triggered	NOT Supported
Light Hit from a Bicycle	Triggered	NOT Triggered	Triggered	Triggered	NOT Supported
Light Hit from a Vehicle	Triggered	Triggered	Triggered	Triggered	NOT Supported
Someone Walking In Front of Your Vehicle	NOT Triggered	Triggered	Triggered	NOT Triggered	NOT Supported
Other Object Moving In Front of Your Vehicle	NOT Triggered	Triggered	Triggered	NOT Triggered	NOT Supported

The FAS-CAM is the only dash cam on the market that is designed with an internal battery that powers parking mode, getting rid of the need to connect your vehicle's fuse box.

7

Settings

7.1 Function Settings



7.1.7 RearCam NightVision

* Connect RearCam to activate this option

NAVIGATION



KEY DEFINITION

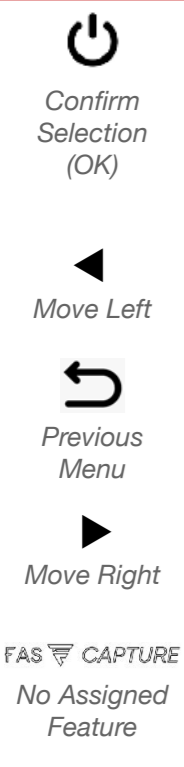

INDICATOR LIGHT

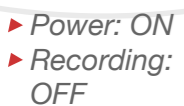

FUNCTION DEFINITION

To enhance RearCam picture quality in order to better fit with different types of scenario.

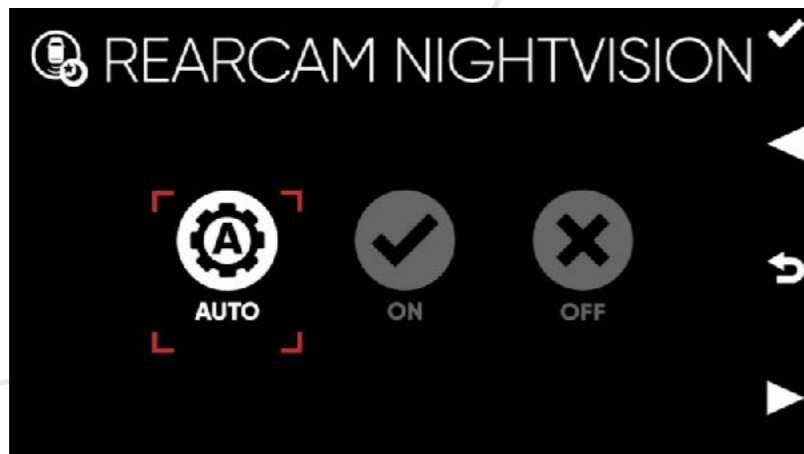
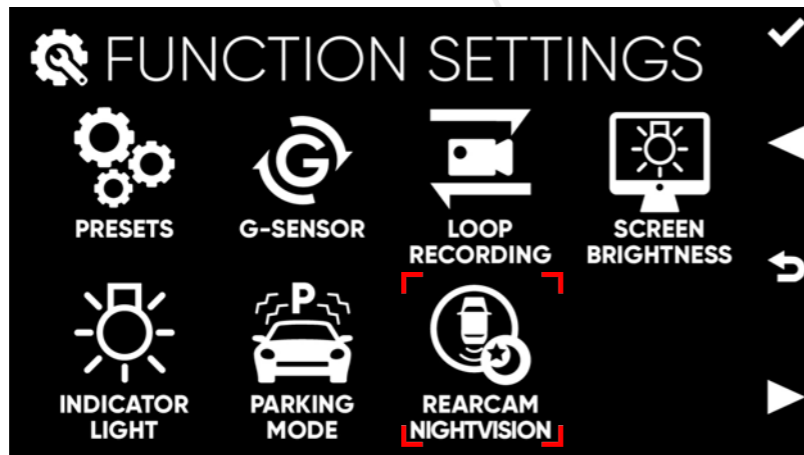

FUNCTION OPTIONS

- ▶ **AUTO**
Automatically adjust “REARCAM NIGHTVISION” base on the surrounding and environment
- ▶ **ON**
F201 is being used as a Cabin View Camera. See Chapter “**9: Cabin View**” for more information.
- ▶ **OFF**
F201 is being used as a Rear View Camera and camera is placed on the rear windshield
- ▶ **Default Setting**
AUTO

AUTO:
NightVision is activated when the environment brightness is lower than 60 illuminance and the exposure is lower than 400 Light Value for 4 seconds.

NightVision is deactivated when the environment brightness is higher than 120 illuminance and the exposure is higher than 600 Light Value for 30 seconds.

7

Settings

7.2 Video Settings



7.2.1 Exposure

NAVIGATION



Main Menu



VIDEO
SETTINGS



EXPOSURE

KEY DEFINITION



Confirm
Selection
(OK)



Move Left



Previous
Menu



Move Right

FAS CAPTURE

No Assigned
Feature

INDICATOR LIGHT

- ▶ Power: ON
- ▶ Recording: OFF

FUNCTION DEFINITION

Exposure is the amount of light that reaches your camera's sensor. Adjust the Exposure level in order to reach a better image quality.

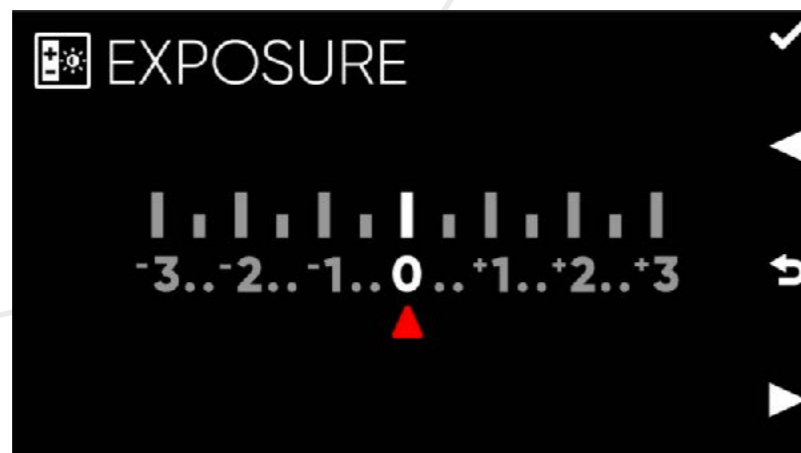

FUNCTION OPTIONS

▶ Exposure level

“-3” is the least Exposure level option

“+3” is the strongest Exposure level option

▶ Default Setting

0

In general, “+” number settings will make the recordings brighter, and “-” number settings will make the recordings darker.

7

Settings

7.2 Video Settings ▶ 7.2.2 Refresh Rate

NAVIGATION



Main Menu



VIDEO
SETTINGS



REFRESH
RATE

KEY DEFINITION



Confirm
Selection
(OK)



Move Left



Previous
Menu



Move Right

FAS CAPTURE

No Assigned
Feature

INDICATOR LIGHT

- ▶ Power: ON
- ▶ Recording: OFF

FUNCTION DEFINITION

To set Refresh Rate base on the requirement of your Country / Region. See Chapter “[12: Troubleshoot](#)” to find your country’s refresh rate.

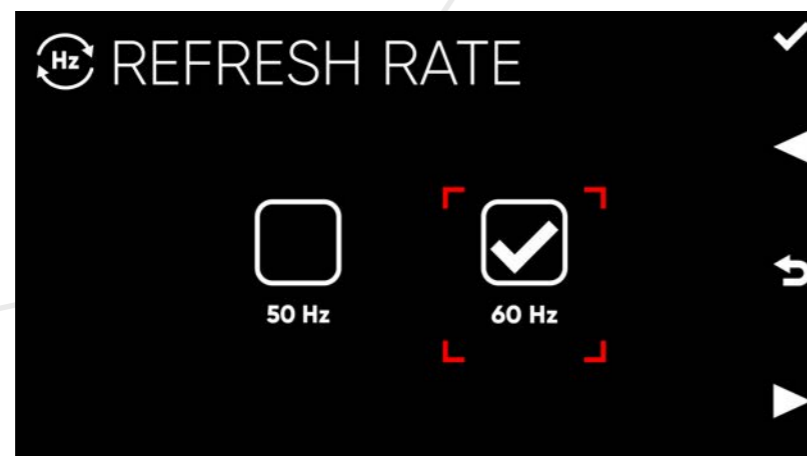
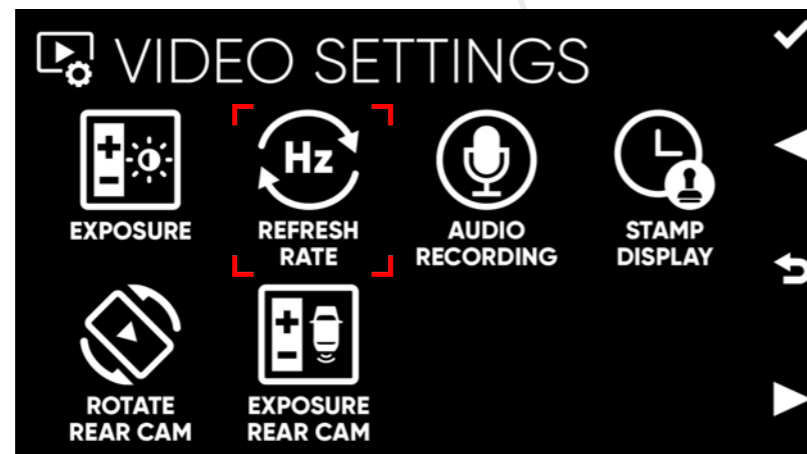

FUNCTION OPTIONS

- ▶ **50 Hz**
- ▶ **60 Hz**
- ▶ **Default Setting**

The default option is Automatically set based on user’s location.

In general, if your local household power voltage is 220v, 50 Hz is recommend, and if your local household power voltage is 120v, 60 Hz is recommend. Please refer to Chapter “[12: Troubleshoot](#)” - Chart “List of Worldwide AC Voltages and Frequencies” in this User Manual for details.

7

Settings

7.2 Video Settings



7.2.3 Audio Recording

NAVIGATION



Main Menu



VIDEO
SETTINGS



AUDIO
RECORDING

KEY DEFINITION



Confirm
Selection
(OK)



Move Left



Previous
Menu



Move Right

FAS CAPTURE

No Assigned
Feature

INDICATOR LIGHT

- ▶ Power: ON
- ▶ Recording: OFF

FUNCTION DEFINITION

To control the audio recording when recording video(s).

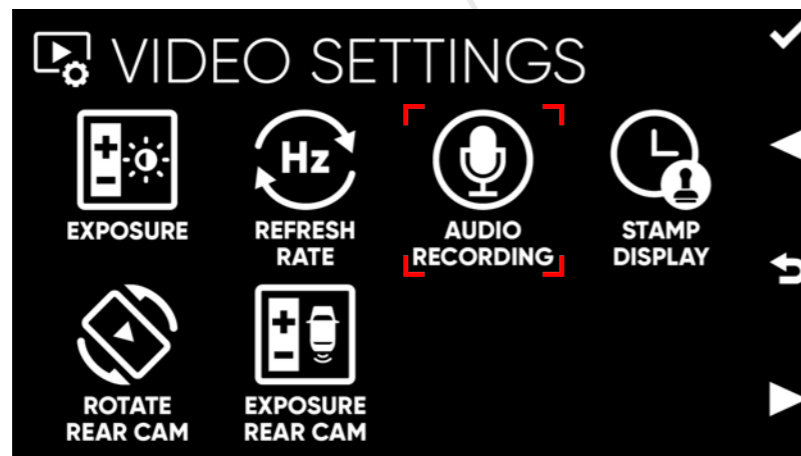

FUNCTION OPTIONS

- ▶ This can also be set at Chapter **“7.1.1 Presets and Audio Recording”**
- ▶ **ON**
Record video with audio recording
- ▶ **OFF**
record video without audio
- ▶ **Default Setting**
The default option is Automatically set based on user's location.

Please follow your local laws and regulations regarding the use of dash cam audio recording

7

Settings

7.2 Video Settings



7.2.4 Stamp Display

NAVIGATION



Main Menu



VIDEO
SETTINGS



STAMP
DISPLAY

KEY DEFINITION



Confirm
Selection
(OK)



Move Left



Previous
Menu



Move Right

FAS CAPTURE

No Assigned
Feature

INDICATOR LIGHT

- ▶ Power: ON
- ▶ Recording: OFF

FUNCTION DEFINITION

To manage all stamp information on the recorded footage. GPS location can be tracked using the DVPlayer, see Chapter **“8: Video Playback App”**

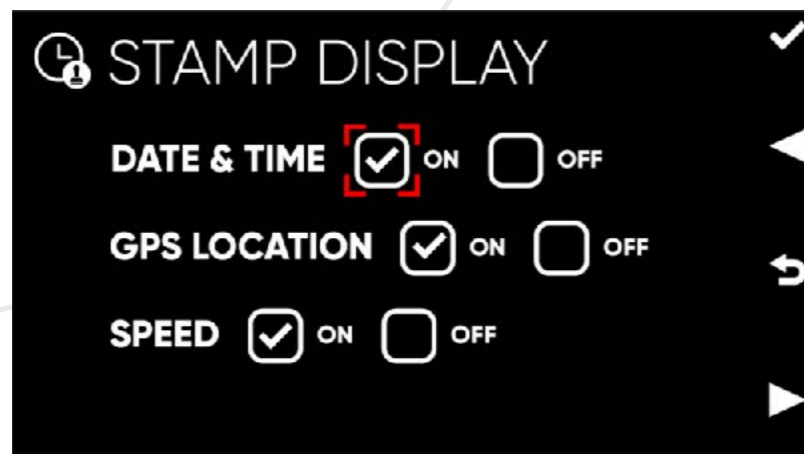
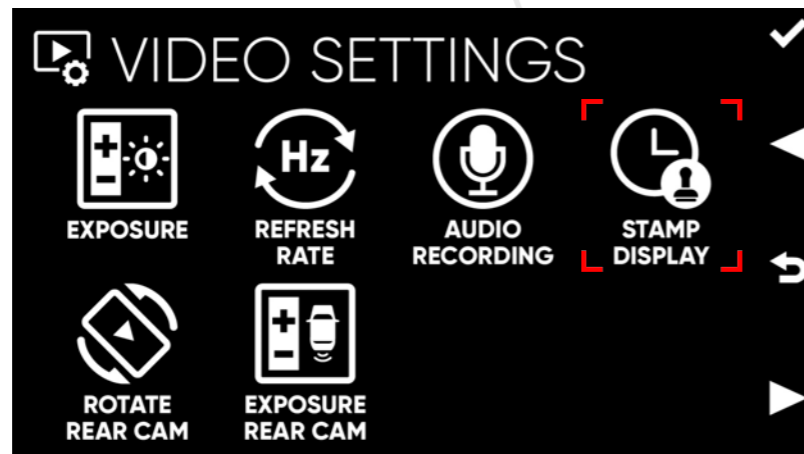

FUNCTION OPTIONS

▶ DATE & TIME

Date: Month-Day-Year “MM-DD-YYYY”

Time: Hour:Minutes:Seconds “HH:MM:SS”

▶ GPS LOCATION

Latitude and Longitude coordinates

▶ SPEED

Recorded in MPH or KPH depending on your settings

▶ Default Setting

All settings are ON

7

Settings

7.2 Video Settings



7.2.5 Rotate Rear Cam

* Connect RearCam to activate this option

NAVIGATION



KEY DEFINITION



INDICATOR LIGHT



FUNCTION DEFINITION

To change the screen display direction for the Rear Camera base on your needs of installation.

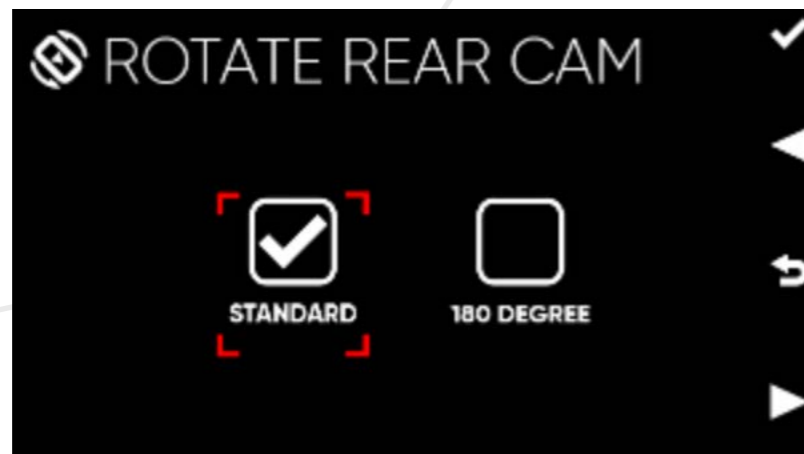
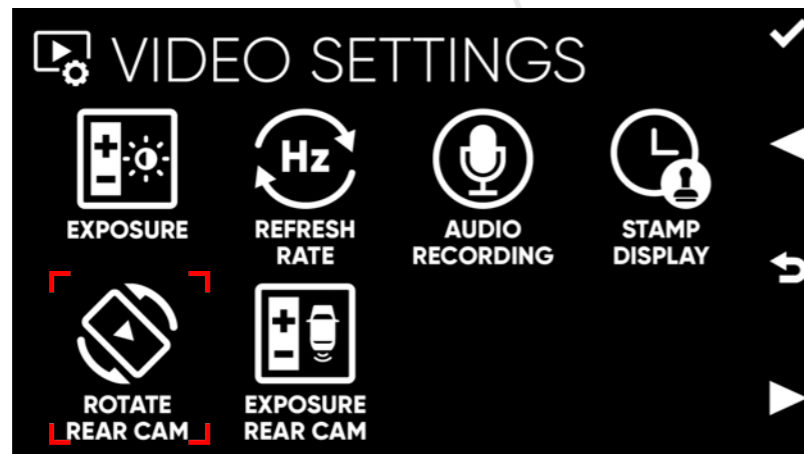

FUNCTION OPTIONS

- ▶ **STANDARD**
If mounting the camera normally on the windshield
- ▶ **180 DEGREE**
Rear Camera Display screen will be rotated 180 if user decides to mount the F201 on the vehicle's dashboard
- ▶ **Default Setting**
STANDARD

7

Settings

7.2 Video Settings

7.2.6 Exposure Rear Cam

* Connect RearCam to activate this option

NAVIGATION

 Main Menu
 ▼
 VIDEO SETTINGS
 ▼
 EXPOSURE REAR CAM

KEY DEFINITION

 Confirm Selection (OK)
 ◀
 Move Left
 ↶
 Previous Menu
 ▶
 Move Right
 FAS CAPTURE
 No Assigned Feature

INDICATOR LIGHT

▶ Power: ON
 ▶ Recording: OFF

FUNCTION DEFINITION

Exposure is the amount of light that reaches your camera's sensor. Adjust the Exposure level in order to reach a better image quality for the F201 camera.

FUNCTION OPTIONS

- ▶ **Exposure level**
 “-3” is the least Exposure level option
 “+3” is the strongest Exposure level option
- ▶ **Default Setting**
 0

In general, “+” number settings will make the recordings brighter, and “-” number settings will make the recordings darker.

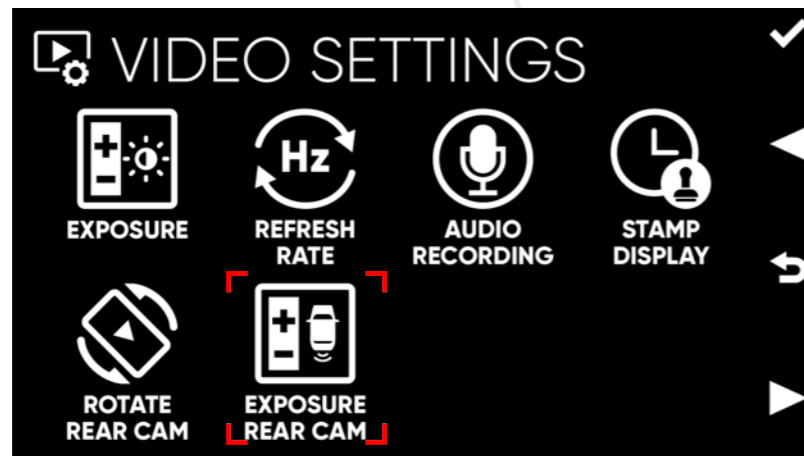

7

Settings

7.3 System Settings

▶ 7.3.1 Date & Time

▶ 7.3.1.1 Enable GPS Date and Time Calibration

NAVIGATION



KEY DEFINITION

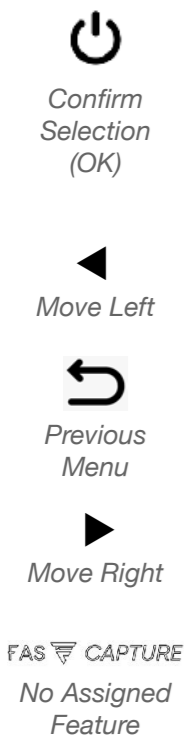

INDICATOR LIGHT

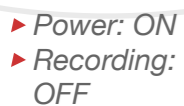

FUNCTION DEFINITION

To set Date and Time setting for the camera using the camera's internal GPS

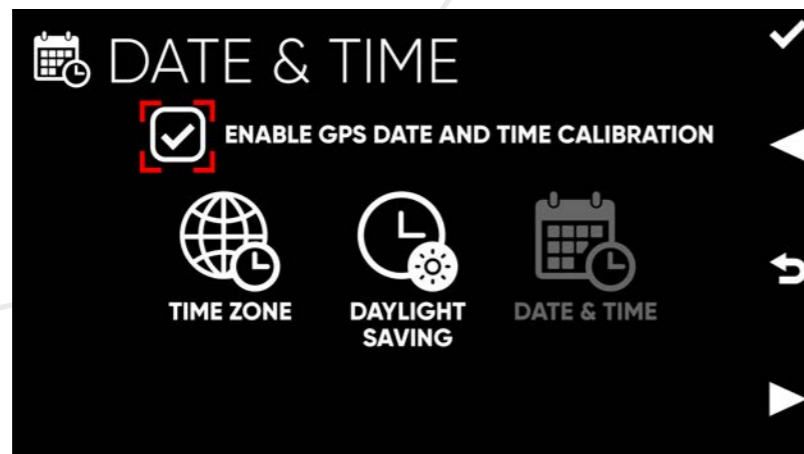
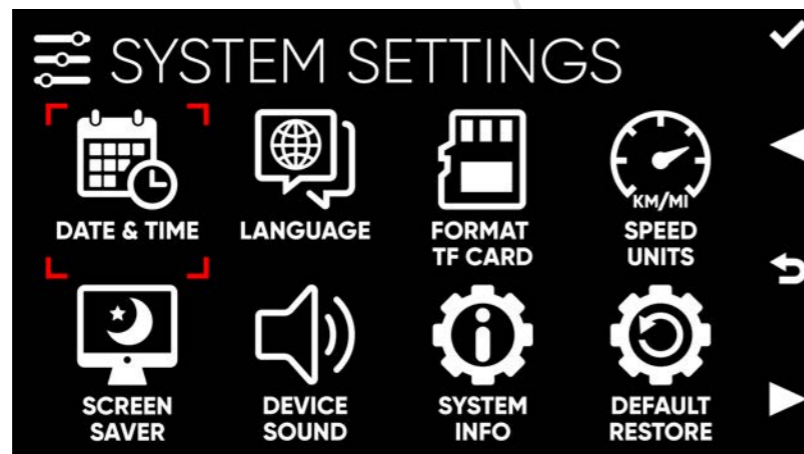

FUNCTION OPTIONS

- ▶ Retrieve the "DATE & TIME" from GPS data automatically (recommended)
- ▶ Unselect Require data to be set manually (see next page to continue with this option)
- ▶ **Default Setting**
 (ON)

This feature, Enable GPS Date and Time Calibration, allows the dash camera to retrieve the GPS time (GMT) and converts into your local time after you select and set your time zone and daylight saving. Please note, GPS signal is required for this feature to work properly.

7

Settings

7.3 System Settings

▶ 7.3.1 Date & Time

▶ 7.3.1.2 Time Zone

FUNCTION DEFINITION

To set Time Zone manually

FUNCTION OPTIONS

- ▶ Press ◀ or ▶ key to find your time zone
- ▶ **Default Setting**
Time zone selection will automatically popup during initial setup

NAVIGATION



KEY DEFINITION



INDICATOR LIGHT



7

Settings

7.3 System Settings

▶ 7.3.1 Date & Time

▶ 7.3.1.3 Daylight Saving

NAVIGATION



KEY DEFINITION



INDICATOR LIGHT

- ▶ Power: ON
- ▶ Recording: OFF

FUNCTION DEFINITION

To switch On or Off Daylight Saving manually

FUNCTION OPTIONS

- ▶ **ON**
If your current location is observing daylight savings time
- ▶ **OFF**
If your current location is observing standard time
- ▶ **Default Setting**
Daylight savings selection will automatically popup during initial setup

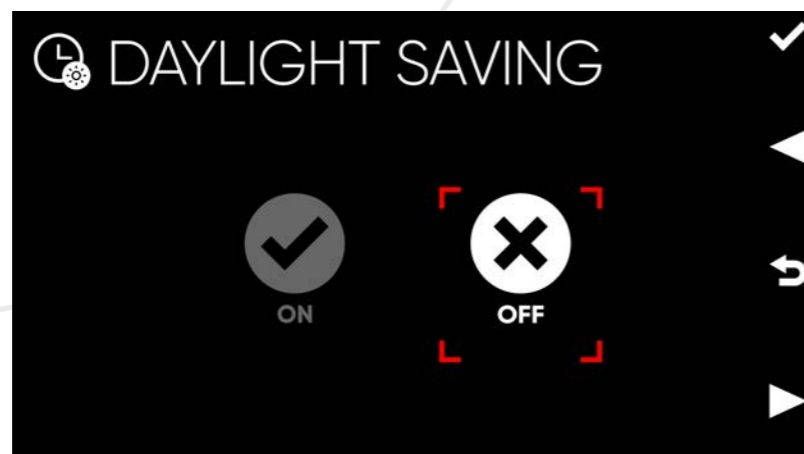

7

Settings

7.3 System Settings

7.3.1 Date & Time

7.3.1.4 Date & Time

NAVIGATION



KEY DEFINITION



INDICATOR LIGHT

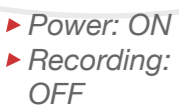

FUNCTION DEFINITION

To set Date and Time manually if “ENABLE GPS DATE AND TIME CALIBRATION” is not selected

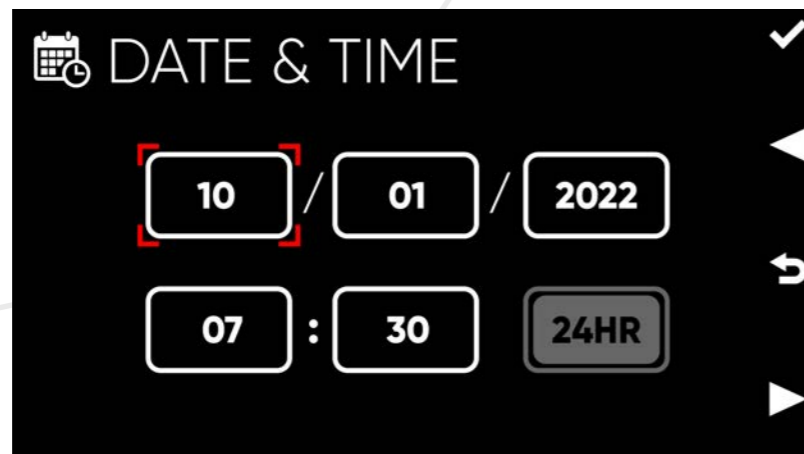
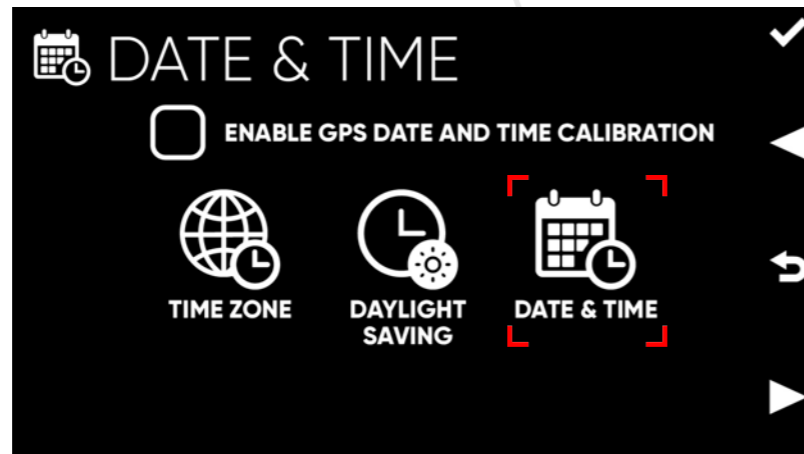

FUNCTION OPTIONS

▶ Default Setting

Date & Time selection will automatically popup during initial setup if “ENABLE GPS DATE AND TIME CALIBRATION” is not selected

DATE FORMAT

Format	MM	/	DD	/	YYYY
Date	10	/	01	/	2022

TIME FORMAT

Format	HH	:	MM	:	24 Hours
Time	07	:	30	:	24HR

7

Settings

7.3 System Settings

▶ 7.3.2 Language

NAVIGATION



Main Menu



SYSTEM
SETTINGS



LANGUAGE

KEY DEFINITION



Confirm
Selection
(OK)



Move Left



Previous
Menu



Move Right

FAS CAPTURE

No Assigned
Feature

INDICATOR LIGHT

- ▶ Power: ON
- ▶ Recording: OFF

FUNCTION DEFINITION

To select language preference

FUNCTION OPTIONS

- ▶ **ENGLISH**
- ▶ **ESPAÑOL**
Spanish
- ▶ **Default Setting**
English
Language selection will automatically
popup during initial setup

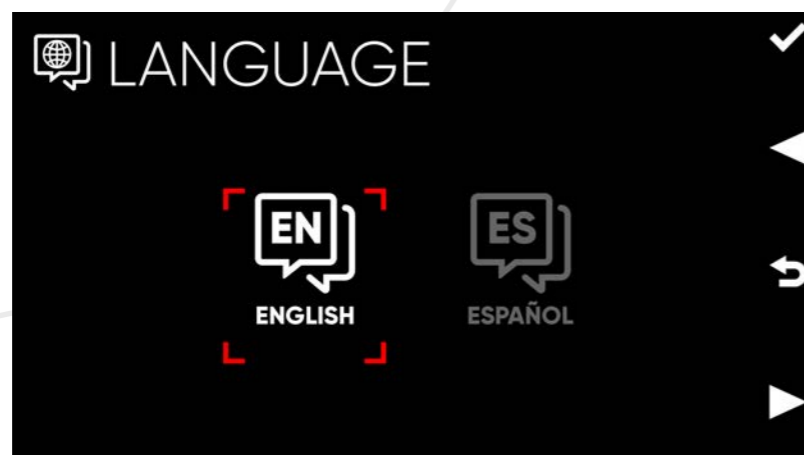
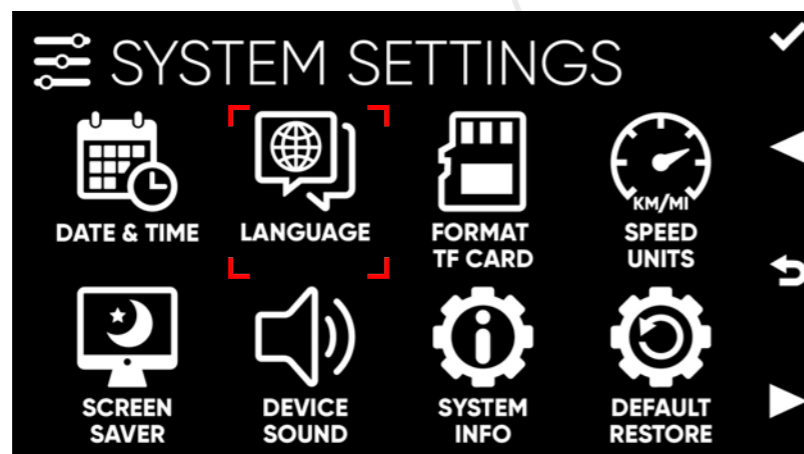

7

Settings

7.3 System Settings

7.3.3 Format TF Card (SD Card)

NAVIGATION



KEY DEFINITION



INDICATOR LIGHT



FUNCTION DEFINITION

To format or reset TF Card (SD Card). This process will delete all files on the memory card.

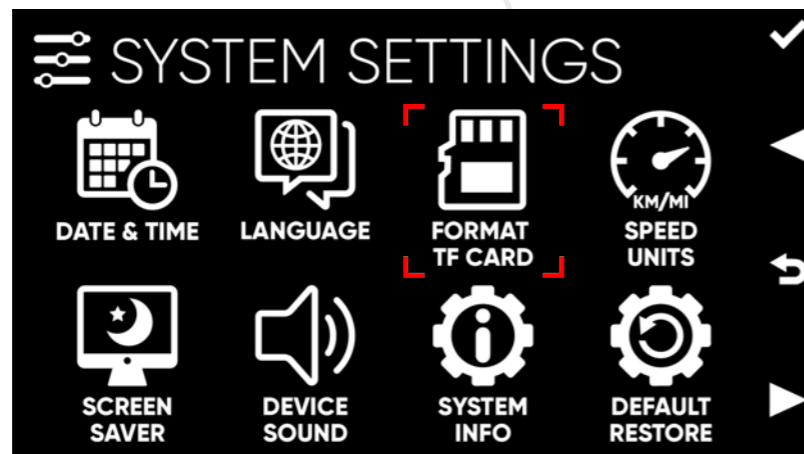

FUNCTION OPTIONS

- ▶ **YES**
FORMAT TF Card (SD Card)
“WARNING MESSAGE”
 - ▶ Select option, and press key to confirm
 - ▶ select option, and press key to exit
- ▶ **“NO”**
Cancel “FORMAT TF CARD”

NOTE: The estimated “Available TF Card (SD Card) Recording Time (Minutes)” info will be displayed at the bottom of the page



7

Settings

7.3 System Settings

▶ 7.3.4 Speed Units

NAVIGATION



Main Menu



SYSTEM
SETTINGS



SPEED
UNITS

KEY DEFINITION



Confirm
Selection
(OK)



Move Left



Previous
Menu



Move Right

FAS CAPTURE

No Assigned
Feature

INDICATOR LIGHT

- ▶ Power: ON
- ▶ Recording: OFF

FUNCTION DEFINITION

To set a preferred Speed Units.

FUNCTION OPTIONS

- ▶ **KM**
Kilometer
- ▶ **MI**
Miles
- ▶ **Default Setting**
MI

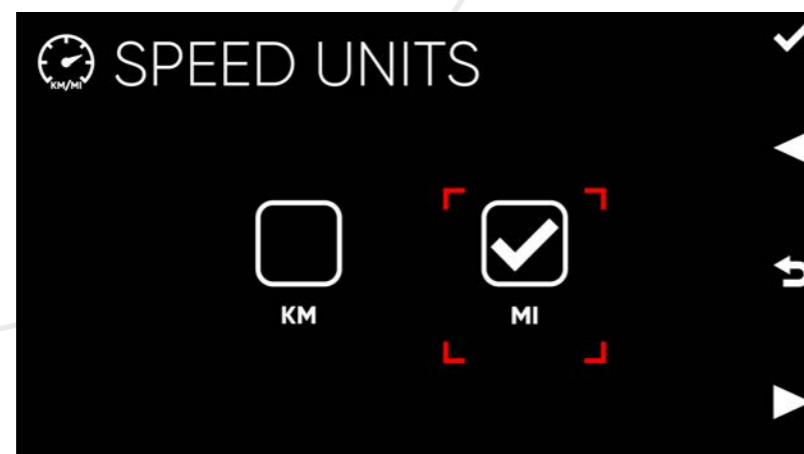
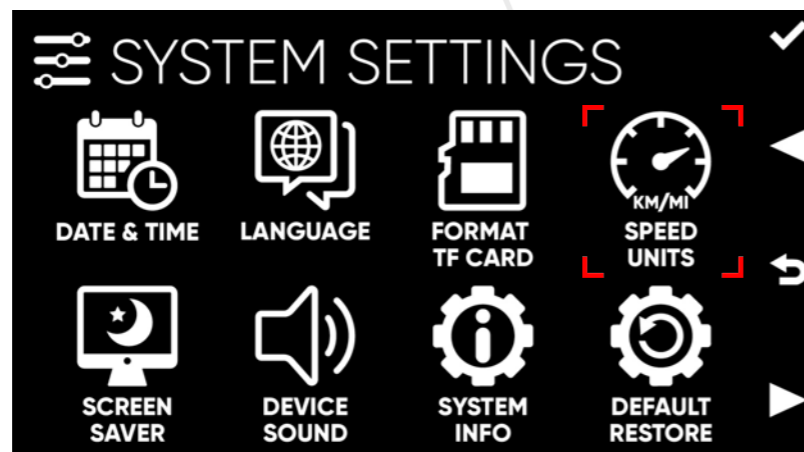

7

Settings

7.3 System Settings

▶ 7.3.5 Screen Saver

NAVIGATION



Main Menu



SYSTEM
SETTINGS



SCREEN
SAVER

KEY DEFINITION



Confirm
Selection
(OK)



Move Left



Previous
Menu



Move Right

FAS CAPTURE

No Assigned
Feature

INDICATOR LIGHT

- ▶ Power: ON
- ▶ Recording: OFF

FUNCTION DEFINITION

To set a preferred Screen Saver time length. The display screen will blackout when there is no activity by the user. Recording will resume as normal.

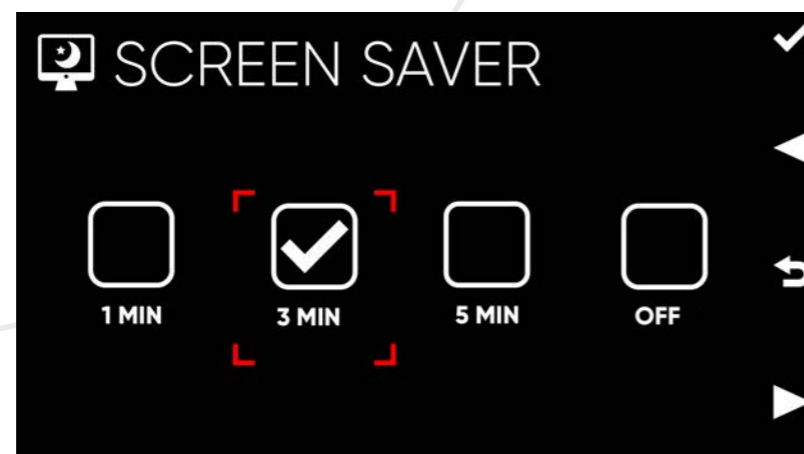
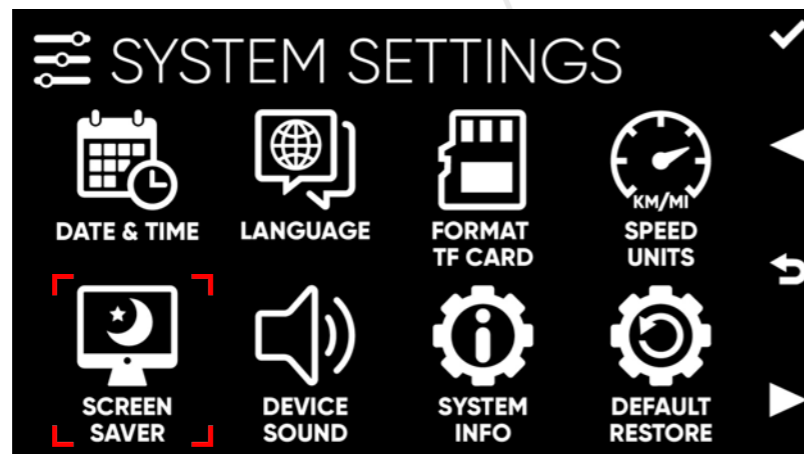

FUNCTION OPTIONS

- ▶ **1 MIN**
- ▶ **3 MIN**
- ▶ **5 MIN**
- ▶ **OFF**
Screen display ON all the time
- ▶ **Default Setting**
3 MIN

7

Settings

7.3 System Settings

▶ 7.3.6 Device Sound

NAVIGATION



Main Menu



SYSTEM
SETTINGS



DEVICE
SOUND

KEY DEFINITION



Confirm
Selection
(OK)



Move Left



Previous
Menu



Move Right

FAS CAPTURE

No Assigned
Feature

INDICATOR LIGHT

- ▶ Power: ON
- ▶ Recording: OFF

FUNCTION DEFINITION

To set the volume of the camera's speaker.

FUNCTION OPTIONS

- ▶ **LOW**
- ▶ **MEDIUM**
- ▶ **HIGH**
- ▶ **OFF**
- ▶ **Default Setting**
MEDIUM

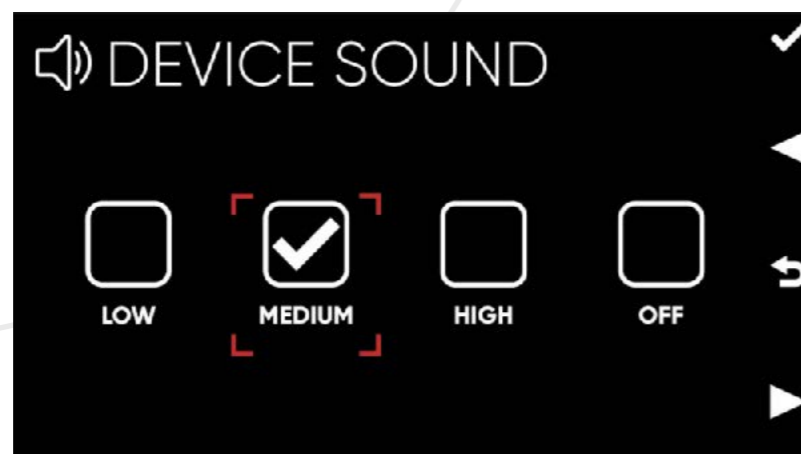
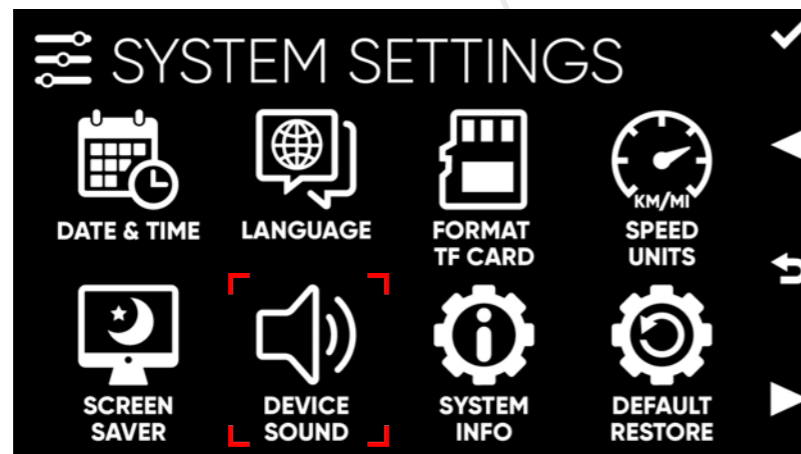

7

Settings

7.3 System Settings

▶ 7.3.7 System Info

NAVIGATION



Main Menu



SYSTEM
SETTINGS



SYSTEM
INFO

KEY DEFINITION



Confirm
Selection
(OK)



Move Left



Previous
Menu



Move Right

FAS CAPTURE

No Assigned
Feature

INDICATOR LIGHT

- ▶ Power: ON
- ▶ Recording: OFF

FUNCTION DEFINITION

To get System Info details.

FUNCTION OPTIONS

- ▶ **MODEL NUMBER**
manufacturer name of device
- ▶ **F701 FIRMWARE VER.**
software installed on F701
- ▶ **F201 FIRMWARE VER.**
software installed on F201

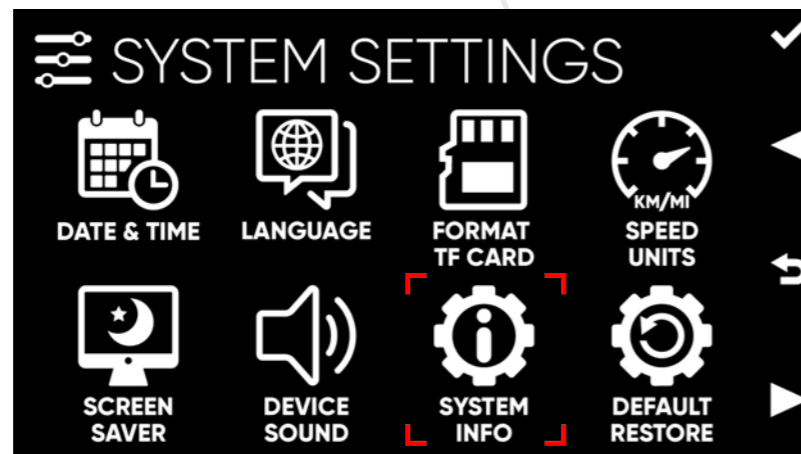

7

Settings

7.3 System Settings

▶ 7.3.8 Default Restore

NAVIGATION



Main Menu



SYSTEM
SETTINGS



DEFAULT
RESTORE

KEY DEFINITION



Confirm
Selection
(OK)



Move Left



Previous
Menu



Move Right

FAS CAPTURE

No Assigned
Feature

INDICATOR LIGHT

- ▶ Power: ON
- ▶ Recording: OFF

FUNCTION DEFINITION

To revert the camera's settings to the default setting. No settings will be saved in the process. Camera will restart as a result.

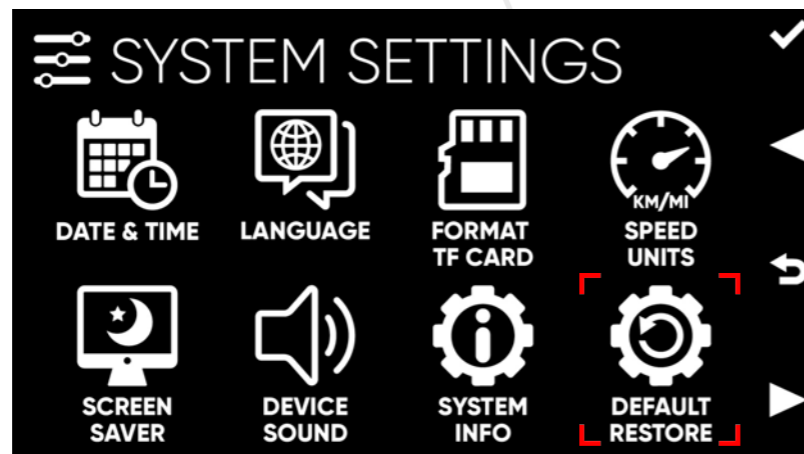

FUNCTION OPTIONS

- ▶ **YES**
DEFAULT RESTORE
“WARNING MESSAGE”
 - ▶ Select option, and press key to confirm
 - ▶ select option, and press key to exit
- ▶ **“NO”**
Cancel “DEFAULT RESTORE”

NOTE: system will reboot and restore itself back to the initial stage. After reboot is completed, user will see the initial startup and setup page (see Chapter “[4.1.2 Unit Test](#)” for details)

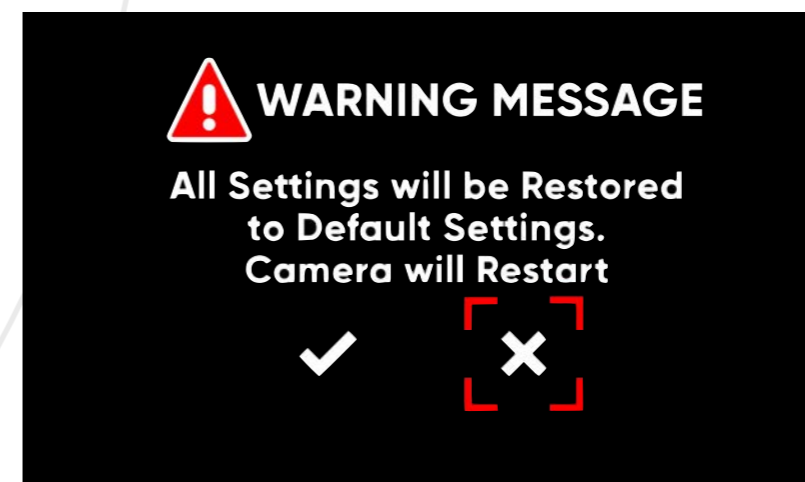

8

GPS Video Playback

8.1 Request for Registration Code

FAS-CAM uses a third-party app that is available on both PC and Mac to play back videos on your computer in full resolution. This 4k dash cam has a built-in GPS to seamlessly record your driving route, driving speed, and other information that can become important evidence in traffic incidents. To watch the GPS videos, simply contact us to acquire a registration code for access to the app using the QR code below.

If you wish to view your video without the GPS tracking information, you can do so by plugging in your SD card into the computer and playing the videos back using a regular video player.

Open your SD Card folder ► CARDV ► VIDEO

After purchase, request for a registration code using our [request form](#). Code will be emailed to you within 2 business days

Each Code can only register on 1 Mac and 1 PC once.



8

GPS Video Playback

8.2 Installing DVPlayer

STEP 1:

Download APP from <https://www.dvplayer.net/setup.html> and install onto your computer

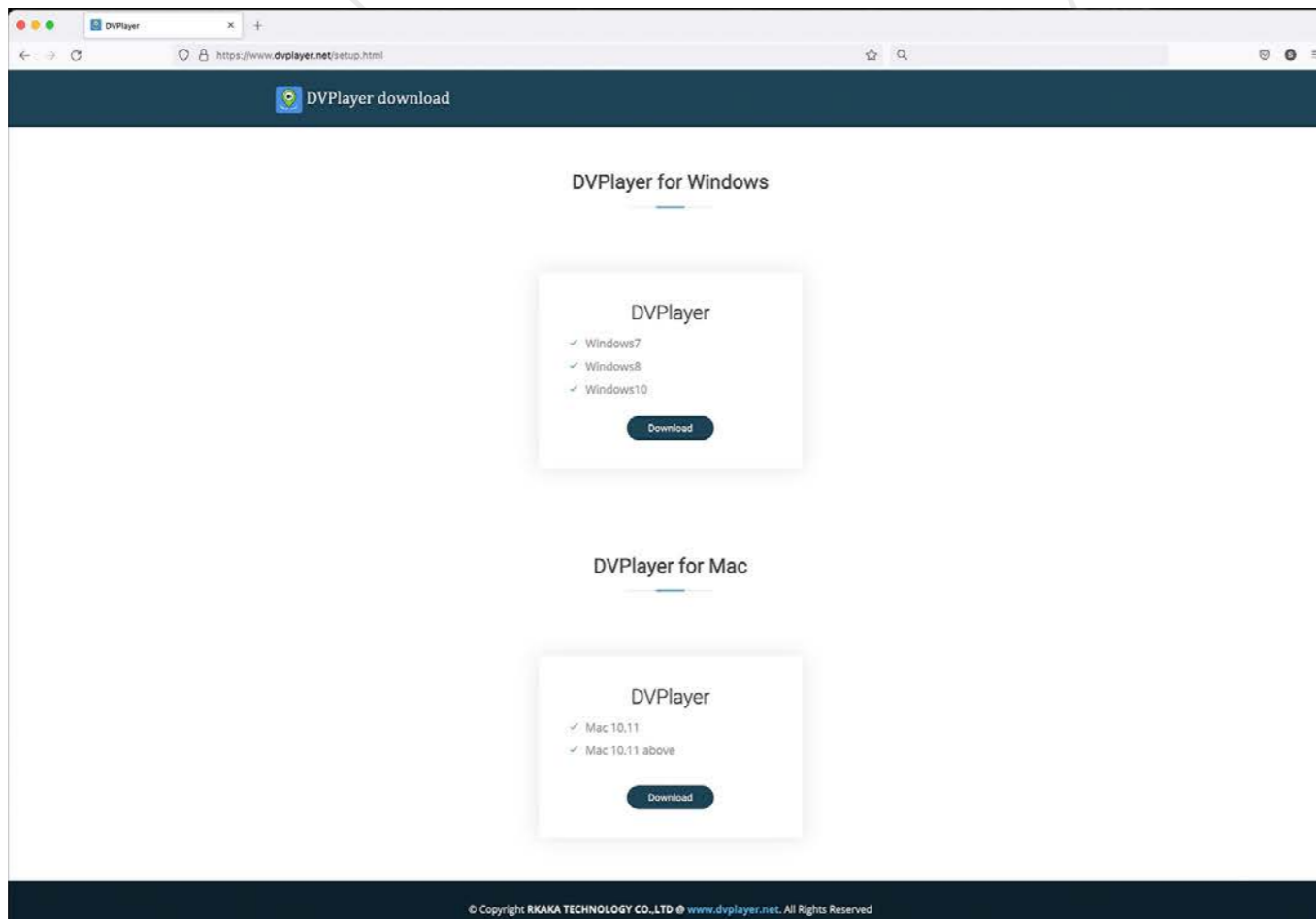

Support Both PC and Mac

8

GPS Video Playback

8.2 Installing DVPlayer

STEP 2: OPEN DVPlayer

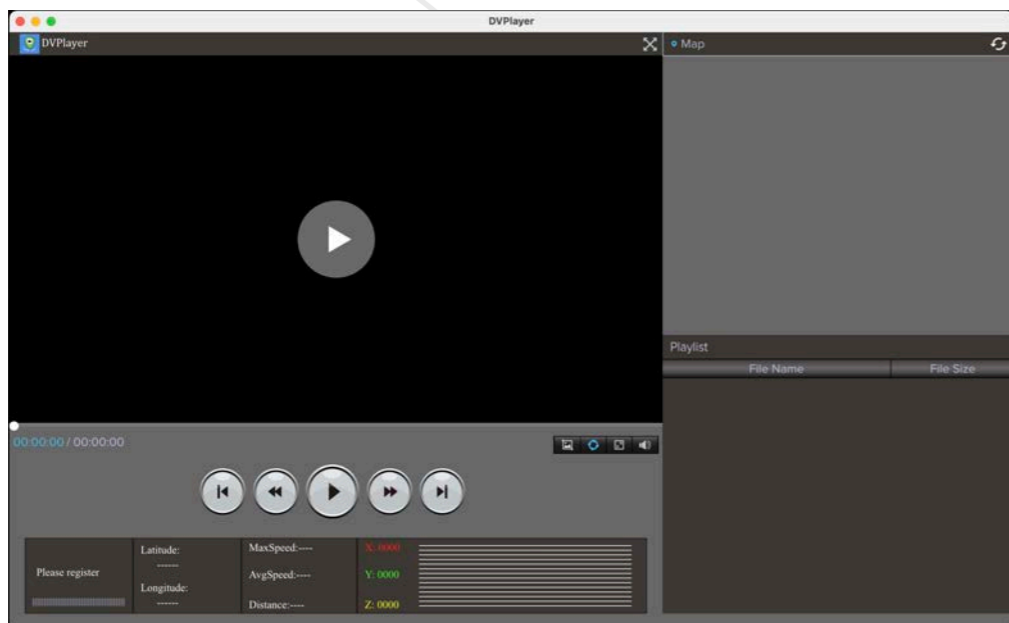

STEP 3: Go to About ▶ Product registration

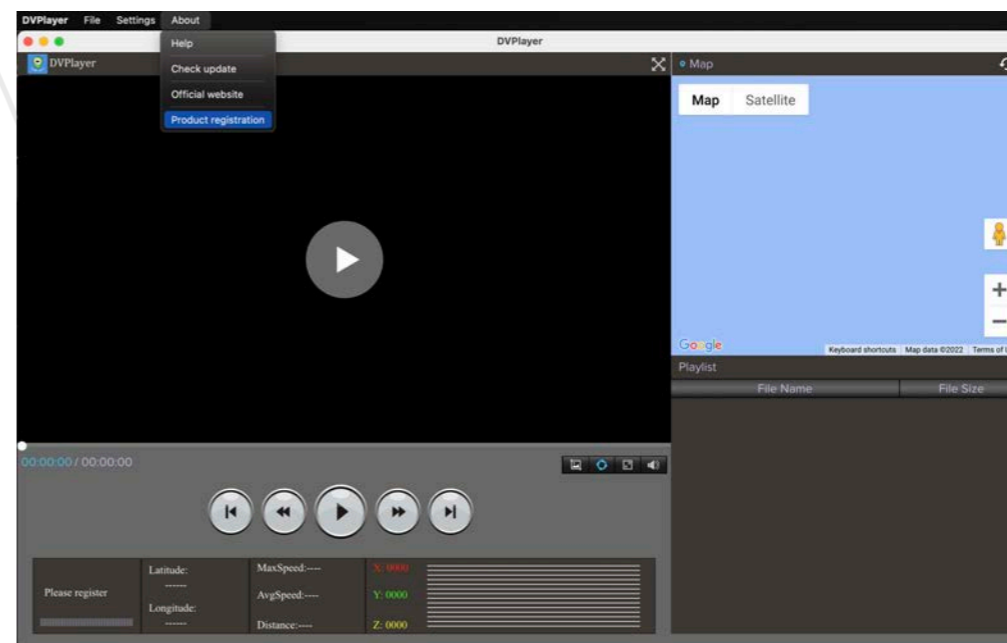

STEP 4: Click "Enter Registration Code"

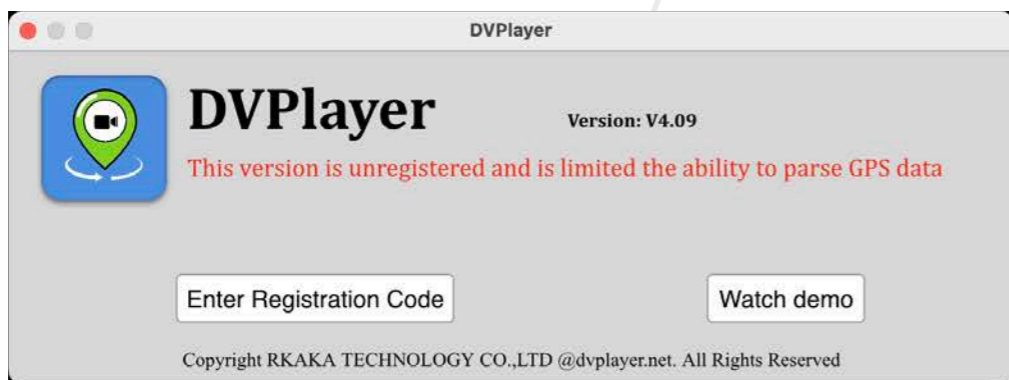

STEP 5: Enter your registration code and Email

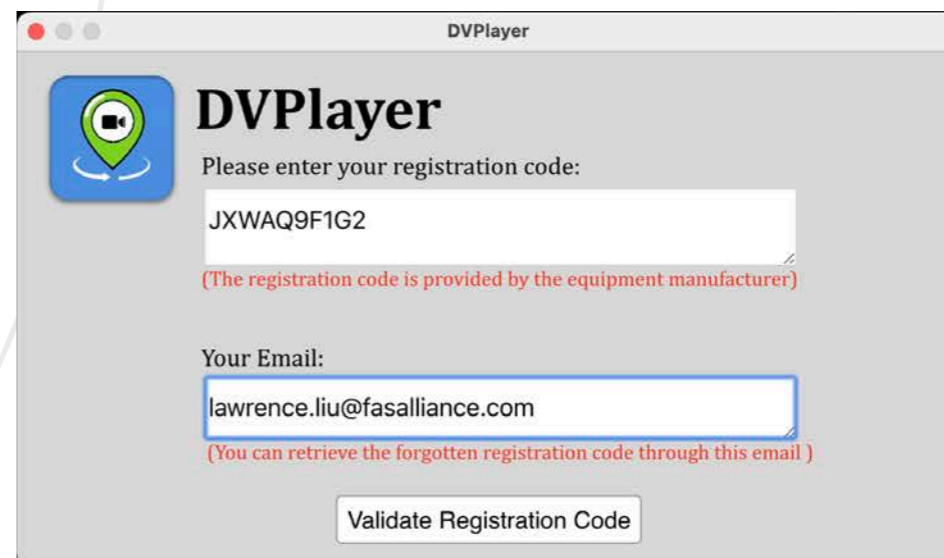

Each Code can only register on 1 Mac and 1 PC once.

8

GPS Video Playback

8.3 Video Playback

STEP 1: Go to File ► Open Folder

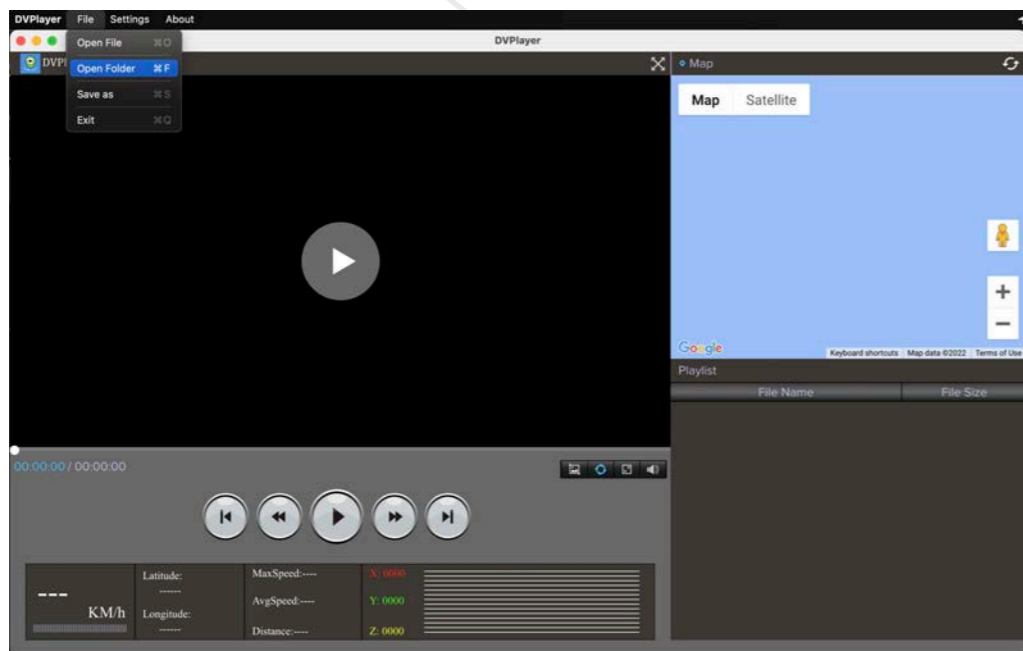

STEP 4: Open your SD Card folder

► **CARDV** ► **VIDEO**

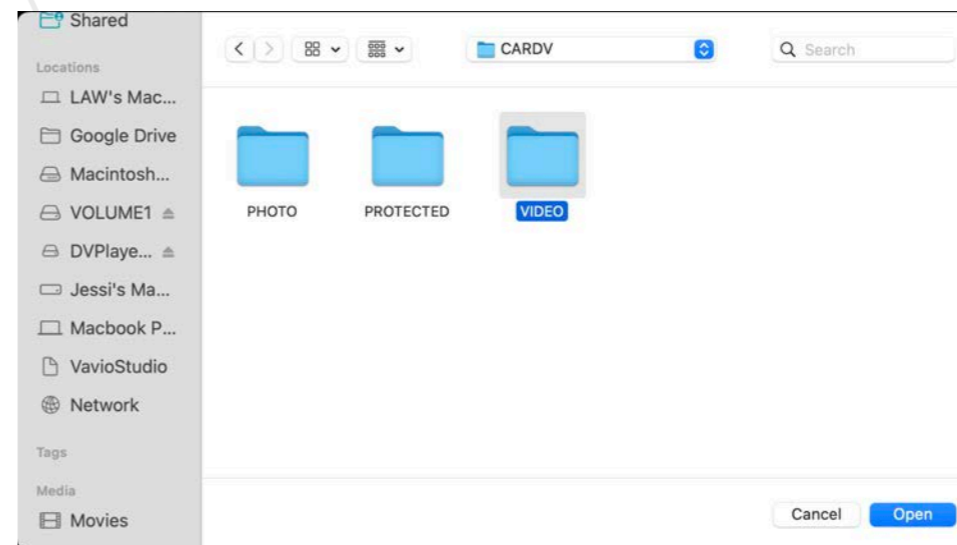

STEP 3: Open your Clip(s)

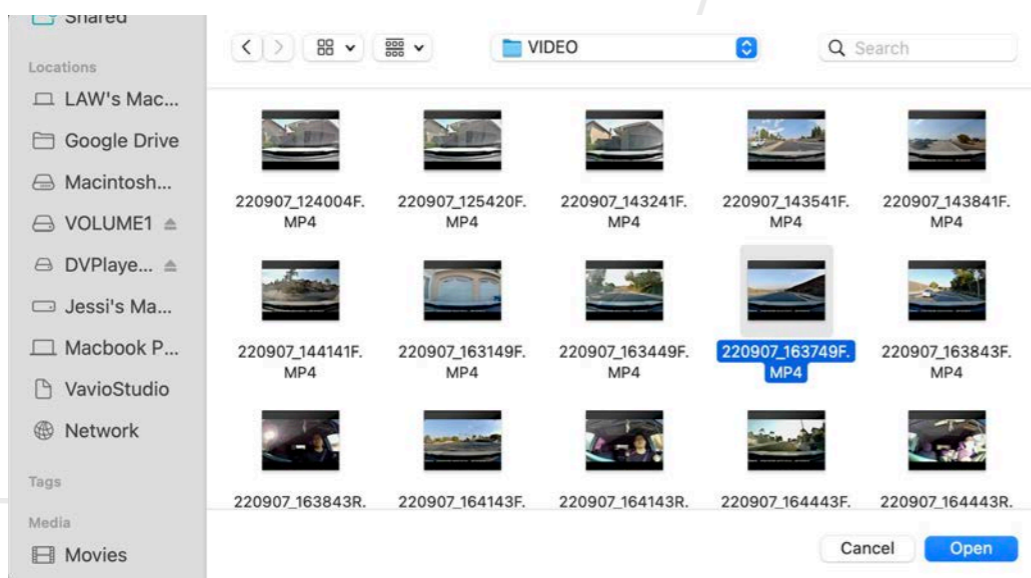

STEP 5: Play your Clip(s)

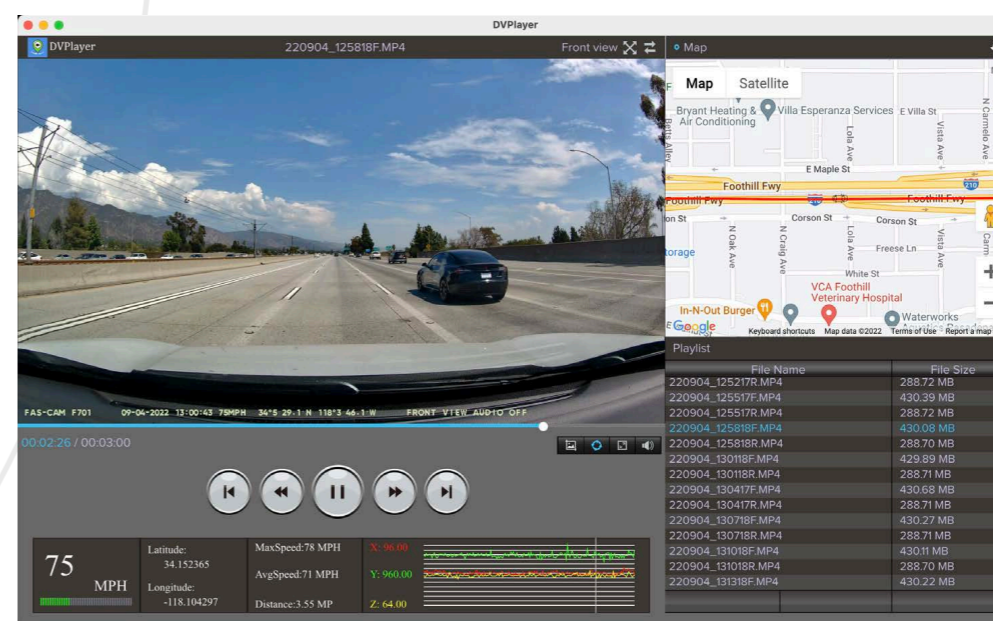

8

GPS Video Playback

8.4 Understanding Video Information

The screenshot shows the DVPlayer interface with several key elements:

- File Name:** 220904_125818F.MP4
- View Type:** Front view
- Map of Travel:** A map showing the vehicle's path along Foothill Fwy.
- Files:** A playlist table listing multiple video files.
- Video Information:** A dashboard at the bottom showing current speed (75 MPH), location (Latitude: 34.152365, Longitude: -118.104297), speed average (71 MPH), and G-sensor movement (X: 96.00, Y: 960.00, Z: 64.00).
- Controls:** Playback controls including Forward, Play/Pause, and Rewind buttons.

Annotations with red circles and lines point to the following features:

- Audio Recording
- View Type
- Longitude
- Latitude
- Speed
- Time HH:MM:SS
- Date MM-DD-YYYY
- Camera Name
- Forward
- Play / Pause
- Rewind
- Current Speed
- Location
- Speed Avg.
- G-Sensor Movement

File Name	File Size
220904_125217R.MP4	288.72 MB
220904_125517F.MP4	430.39 MB
220904_125517R.MP4	288.72 MB
220904_125818F.MP4	430.08 MB
220904_125818R.MP4	288.70 MB
220904_130118F.MP4	429.89 MB
220904_130118R.MP4	288.71 MB
220904_130417F.MP4	430.68 MB
220904_130417R.MP4	288.71 MB
220904_130718F.MP4	430.27 MB
220904_130718R.MP4	288.71 MB
220904_131018F.MP4	430.11 MB
220904_131018R.MP4	288.70 MB
220904_131318F.MP4	430.22 MB

9

Cabin View

Our F201-IR camera is interchangeable to record either the interior OR exterior of your vehicle. Simply by changing the wiring and placement of the camera, you can easily choose the view that would benefit you the most.



10

Firmware

10.1 Firmware Version and Product Registration

Firmware controls the basic functioning of your dash cam. If your dash cam is NOT functioning correctly, you may need to update the firmware for your device. Updates may also be released to fix bugs, and improve the general functionality of the dash cam. It's important to keep the firmware on your dash cam up-to-date so it can operate to its full capacity and functionality.

The latest firmware version is always available at FAS Alliance official website <https://fasalliance.com>.

We strongly recommend registering your product to receive notification emails when new firmware updates are available.

[**Register Your Product Here**](#)

10.2 Firmware Update

- ▶ Insert TF Card (SD Card) from the dash cam to a card reader and connect the card reader to a PC or laptop.
- ▶ Open the TF Card (SD Card) folder on your computer.
- ▶ Download the latest firmware by going to our website and finding your product. The latest firmware will be under the “Firmware Tab”.
- ▶ Drag and drop the file / folder to the TF Card (SD Card) drive (DO NOT put the firmware file in any folder in the TF Card (SD Card) drive. Leave the file in the TF Card (SD Card) drive’s “Root Directory”).
- ▶ Eject the TF Card (SD Card) on your PC or laptop, and insert it back into dash cam’s TF Card slot.
- ▶ The dash cam will be turned on when power is supplied and the latest Firmware will automatically begin updating. The FAS-CAPTURE light will be blinking red.
- ▶ Once the update is completed, the dash cam will automatically restart.
- ▶ After restarting, we recommend to do the TF Card (SD Card) format after you complete the firmware installation. See Chapter “**7.3.3 Format TF Card (SD Card)**” for more information

The Firmware Update must be completed before the camera can be used.
Files saved on the TF Card (SD Card) will NOT be affected by the firmware update



Bug Reports, Suggestions, & Feedback



See a bug? While we do multiple test runs before each firmware releases, it is still impossible to catch them all. We rely on user inputs to make sure that our dash cam runs as smoothly as possible. We would also love to hear from you. Please send us suggestions on how what you would like to see in our future releases.

11

Specifications

11.1 Front Camera F701-DR

Attribute	Specification / Description
Model	F701-DR
Processor	NOVATEK
Image Sensor	Sony STARVIS
Display	3-Inch LCD
Lens	IMX-415
Language	English, Spanish
Camera Resolution	Dual Channel / Cam recording: UHD 4K 3840 X 2160P / Rear FHD 2.5K 2160 X 1440P Single Channel/ Front Cam recording: UHD 4K 3840 X 2160P
Video Format	MOV
Image Format	JPG
Audio	Built-in Microphone and Speaker
GPS	Built-in
USB Port	USB Type-C (Data and Power)
Battery	Lithium
Working Temperature	-15°C ~ 65°C (5°F ~ 149°F)
Storage Temperature	-25°C ~ 75°C (-13°F ~ 167°F)
Compatible Operating System	Windows / IOS
TF Card (SD Card) Storage Support	TF Card (SD Card) up to 256GB (NOT Included) * The High-spec dedicated card above U3 for Dash Cam is required

* The specifications of this product may change without prior notice due to product improvements.

11

Specifications

11.2 Rear Camera F201-IR (Optional)

Attribute	Specification / Description
Model	F201-IR
Processor	NOVATEK
Image Sensor	Sony STARVIS
Lens	IMX-335
Camera Resolution	FHD 2.5K 2160 X 1440P
Video Format	MOV
Image Format	JPG
Audio	Built-in Microphone and Speaker
GPS	Built-in
Working Temperature	-15°C ~ 65°C (5°F ~ 149°F)
Storage Temperature	-25°C ~ 75°C (-13°F ~ 167°F)
Compatible Operating System	Windows / IOS

* The specifications of this product may change without prior notice due to product improvements.

12 Troubleshoot

Event	Message	Solution
Micro TF Card (SD Card) NOT Inserted	Please Insert Micro TF Card (SD Card)	Insert Micro TF Card (SD Card)
Micro TF Card (SD Card) Reading Component Malfunction	Micro TF Card (SD Card) Access Failed	Contact our customer service representative
Micro TF Card (SD Card) Malfunction	Micro TF Card (SD Card) Malfunction	Please replace micro TF Card (SD Card). Make sure you are using a recommended TF Card. See Chapter “ Introduction ”
Power-on Failed	N/A	Ensure the power cable and front camera are firmly connected to the front camera mount
System Crash After Power-On	N/A	Use a pin to insert and press the reset button on the front camera
Screen is Blurry	N/A	Use a pin to insert and press the reset button on the front camera
Screen is Flickering	N/A	Use a pin to insert and press the reset button on the front camera
Recorded Video Can't be Saved	N/A	Contact our customer service representative
Recording Light Failed	N/A	Ensure the original power cable is used. This issue might be caused by the low voltage from the power supply.
No Responses When Pressing Keys	N/A	Use a pin to insert and press the reset button on the front camera
System Crash	N/A	Use a pin to insert and press the reset button on the front camera
Front Camera is Overheating	N/A	Contact our customer service representative
Rear Camera is Connected but No Rear View Showing on Screen	N/A	Ensure the rear camera cable is properly and firmly connected
System is Taking Longer Than 5 Minutes To Acquire Satellite Signal	N/A	Make sure the vehicle is in an open area without obstacles on top of the vehicle.
Front Camera is Connected to Front Camera Mount, But The GPS Icon is Showing GPS NOT Available	N/A	Make sure the vehicle is in an open area without obstacles on top of the vehicle.

* If the issue proceeds after applying the solution, please contact our customer service team support@fasalliance.com

12 Troubleshoot

List of Worldwide AC Voltages and Frequencies

Country	Voltage	Frequency	Country	Voltage	Frequency	Country	Voltage	Frequency	Country	Voltage	Frequency	Country	Voltage	Frequency
Afghanistan	220V	50Hz	China	220V	50Hz	Guam	110V	60Hz	Malta	230V	50Hz	Saudi Arabia	127/220V	60Hz
Albania	230V	50Hz	Colombia	110V	60Hz	Guatemala	120V	60Hz	Martinique	220V	50Hz	Senegal	230V	50Hz
Algeria	230V	50Hz	Comoros	220V	50Hz	Guinea	220V	50Hz	Mauritania	220V	50Hz	Serbia & Montenegro	230V	50Hz
American Samoa	120V	60Hz	Congo (Zaire)	220V	50Hz	Guinea-Bissau	220V	50Hz	Mauritius	230V	50Hz	Seychelles	240V	50Hz
Andorra	230V	50Hz	Cook Islands	240V	50Hz	Guyana	110/220V	60Hz	Mexico	127V	60Hz	Sierra Leone	230V	50Hz
Angola	220V	50Hz	Costa Rica	120V	60Hz	Haiti	110V	60Hz	Micronesia	120V	60Hz	Singapore	230V	50Hz
Anguilla	110V	60Hz	Côte d'Ivoire (Ivory Coast)	220V	50Hz	Honduras	110V	60Hz	Moldova	230V	50Hz	Slovakia	230V	50Hz
Antigua	230V	60Hz	Croatia	230V	50Hz	Hong Kong	220V	50Hz	Monaco	230V	50Hz	Slovenia	230V	50Hz
Argentina	220V	50Hz	Cuba	110/220V	60Hz	Hungary	230V	50Hz	Mongolia	230V	50Hz	Somalia	220V	50Hz
Armenia	230V	50Hz	Cyprus	230V	50Hz	Iceland	230V	50Hz	Montserrat Islands	230V	60Hz	South Africa	230V	50Hz
Aruba	127V	60Hz	Czech Republic	230V	50Hz	India	240V	50Hz	Morocco	220V	50Hz	Spain	230V	50Hz
Australia	240V	50Hz	Denmark	230V	50Hz	Indonesia	230V	50Hz	Mozambique	220V	50Hz	Sri Lanka	230V	50Hz
Austria	230V	50Hz	Djibouti	220V	50Hz	Iran	230V	50Hz	Myanmar (Burma)	230V	50Hz	Sudan	230V	50Hz
Azerbaijan	220V	50Hz	Dominica	230V	50Hz	Iraq	230V	50Hz	Namibia	220V	50Hz	Suriname	127V	60Hz
Azores	230V	50Hz	Dominican Republic	110V	60Hz	Ireland (Eire)	230V	50Hz	Nauru	240V	50Hz	Swaziland	230V	50Hz
Bahamas	120V	60Hz	East Timor	220V	50Hz	Isle of Man	230V	50Hz	Nepal	230V	50Hz	Sweden	230V	50Hz
Bahrain	230V	50Hz	Ecuador	127V	60Hz	Israel	230V	50Hz	Netherlands	230V	50Hz	Switzerland	230V	50Hz
Balearic Islands	230V	50Hz	Egypt	220V	50Hz	Italy	230V	50Hz	Netherlands Antilles	127/220V	50Hz	Syria	220V	50Hz
Bangladesh	220V	50Hz	El Salvador	115V	60Hz	Jamaica	110V	50Hz	New Caledonia	220V	50Hz	Tahiti	110/220V	60Hz
Barbados	115V	50Hz	Equatorial Guinea	220V	50Hz	Japan	100V	50/60Hz	New Zealand	230V	50Hz	Tajikistan	220V	50Hz
Belarus	230V	50Hz	Eritrea	230V	50Hz	Jordan	230V	50Hz	Nicaragua	120V	60Hz	Taiwan	110V	60Hz
Belgium	230V	50Hz	Estonia	230V	50Hz	Kenya	240V	50Hz	Niger	220V	50Hz	Tanzania	230V	50Hz
Belize	110/220V	60Hz	Ethiopia	220V	50Hz	Kazakhstan	220V	50Hz	Nigeria	240V	50Hz	Thailand	220V	50Hz
Benin	220V	50Hz	Faeroe Islands	230V	50Hz	Kiribati	240V	50Hz	Norway	230V	50Hz	Togo	220V	50Hz
Bermuda	120V	60Hz	Falkland Islands	240V	50Hz	Korea, South	220V	60Hz	Okinawa	100V	60Hz	Tonga	240V	50Hz
Bhutan	230V	50Hz	Fiji	240V	50Hz	Kuwait	240V	50Hz	Oman	240V	50Hz	Trinidad & Tobago	115V	60Hz
Bolivia	230V	50Hz	Finland	230V	50Hz	Kyrgyzstan	220V	50Hz	Pakistan	230V	50Hz	Tunisia	230V	50Hz
Bosnia	230V	50Hz	France	230V	50Hz	Laos	230V	50Hz	Palmyra Atoll	120V	60Hz	Turkey	230V	50Hz
Botswana	230V	50Hz	French Guyana	220V	50Hz	Latvia	230V	50Hz	Panama	110V	60Hz	Turkmenistan	220V	50Hz
Brazil	110/220V	60Hz	Gaza	230V	50Hz	Lebanon	230V	50Hz	Papua New Guinea	240V	50Hz	Uganda	240V	50Hz
Brunei	240V	50Hz	Gabon	220V	50Hz	Lesotho	220V	50Hz	Paraguay	220V	50Hz	Ukraine	230V	50Hz
Bulgaria	230V	50Hz	Gambia	230V	50Hz	Liberia	220V	50Hz	Peru	220V	60Hz	United Arab Emirates	220V	50Hz
Burkina Faso	220V	50Hz	Germany	230V	50Hz	Libya	127/230V	50Hz	Philippines	110/220V	60Hz	United Kingdom (UK)	230/240V	50Hz
Burundi	220V	50Hz	French Guyana	220V	50Hz	Lithuania	230V	50Hz	Poland	230V	50Hz	United States (USA)	120/240V	60Hz
Cambodia	230V	50Hz	Gaza	230V	50Hz	Liechtenstein	230V	50Hz	Portugal	230V	50Hz	Uruguay	220V	50Hz
Cameroon	220V	50Hz	Gabon	220V	50Hz	Luxembourg	230V	50Hz	Puerto Rico	120V	60Hz	Uzbekistan	220V	50Hz
Canada	120/240V	60Hz	Gambia	230V	50Hz	Macau	220V	50Hz	Qatar	240V	50Hz	Venezuela	120V	60Hz
Canary Islands	230V	50Hz	Germany	230V	50Hz	Macedonia	230V	50Hz	Réunion Island	230V	50Hz	Vietnam	220V	50Hz
Cape Verde	230V	50Hz	Ghana	230V	50Hz	Madagascar	127/220V	50Hz	Romania	230V	50Hz	Virgin Islands	110V	60Hz
Cayman Islands	120V	60Hz	Gibraltar	230V	50Hz	Madeira	230V	50Hz	Russian Federation	230V	50Hz	Western Samoa	230V	50Hz
Central Africa	220V	50Hz	Greece	230V	50Hz	Malawi	230V	50Hz	Rwanda	230V	50Hz	Yemen	230V	50Hz
Chad	220V	50Hz	Greenland	230V	50Hz	Malaysia	240V	50Hz	St. Kitts & Nevis	230V	60Hz	Zambia	230V	50Hz
Channel Islands	230V	50Hz	Grenada	230V	50Hz	Maldives	230V	50Hz	St. Lucia Island	240V	50Hz	Zimbabwe	220V	50Hz
Chile	220V	50Hz	Guadeloupe	230V	50Hz	Mali	220V	50Hz	St. Vincent Island	230V	50Hz			

Warranty and Product Support

13.1 Warranty

1 YEAR LIMITED WARRANTY

FAS Alliance Inc. provides a limited warranty to the original purchaser for the following period from the purchasing date against deficiencies in material and workmanship under normal use. Should this unit fail to operate in a satisfactory manner within the warranty period, FAS Alliance Inc. will, at its discretion, exchange or refund the product.

Main Dashboard Video Cameras (Dash Cam) Unit in Box: 1 Year All Accessories: 1 Year

Original purchase receipt is required when claiming warranty.

If this dash cam fails to operate in a satisfactory manner, it is best to contact the store where it was originally purchased. If the store fails to resolve the issue(s) and if you believe your dash cam meets the criteria for a warranty exchange or refund, please contact us by email at support@fasalliance.com

This limited warranty does not cover and is not limited to the following conditions:

- ▶ If the device was not purchased from an authorized FAS Alliance Inc. retailer
- ▶ Device malfunction or damages caused by improper usage
- ▶ FAS Alliance Inc. is not liable for any damages (properties, business, and/or indirect damages), loss or corruption of data for any reason, and product damage or personal injuries that occur due to accidents or natural disasters.
- ▶ FAS Alliance Inc. Dash Cam records and saves videos of vehicle accidents. It is not guaranteed to record all accidents.

13

Warranty and Product Support

13.2 Product Support

For product support, firmware updates, or different language version of our manuals please visit <https://fasalliance.com>.

You can also email us at support@fasalliance.com.

Before Requesting Service

Please back up all important files and data before requesting service. In order to service the dash cam it may be necessary to delete all files and data from the dash cam. All servicing is provided on the basis that the user has backed up all necessary files and data before requesting service. Therefore FAS Alliance will NOT be responsible for the loss of any files or data.

Your Opinion Matters

FAS Alliance is firmly committed to always improving our products, services, and user experience.

If you have any thoughts on how we can do even better, your constructive feedback and suggestions will be greatly appreciated.

Connect with us today at support@fasalliance.com.



**Thank you for choosing
FAS-ALLIANCE !**

