



# AVOL™

The genius of electricity



## Genius Series

AVOL™ electrical & lighting solutions.



# Take the first steps in clean, affordable energy with **AVOL™ Genius**



**Be a part of the millions of Australian households that have installed solar + battery systems and reap the benefits.**

## **Who?**

At AVOL™, we are committed to bringing Australian home & business owners clean & affordable energy solutions through innovation and research.

## **How?**

Our solutions aim to reduce energy consumption, pollution and minimise harm to the environment, whilst being price-conscious so that solutions are more accessible for Australian households.



## Combat rising power prices and become self-sufficient

Power your home, earn feed-in tariff and cut your power bill with AVOL™ Genius. Gain your energy independence and save money by switching to a solar + battery system.

## Battery backup power when you need it most

Keep the family protected by having battery storage. This enables essential appliances to continue running in an event of a blackout.



## Access your energy: Anywhere, anytime

See the energy you are producing, storing and using with the “SOLARMAN Smart” mobile app.

## Lower your carbon emissions for a better tomorrow



# Scalable solar + battery solutions for a energy efficient future



## Fast-track your way to being self-sufficient

Harness the power of the sun, and maximise profit from producing clean, renewable energy with AVOL™ Genius Series solar and battery storage solutions.



Up to 20kWh battery storage



Premium CATL battery cells



Flexible & robust solar panels



Easy monitoring with phone app



Cost and energy savings



Streamline modular design



New or retrofit with existing PV system

## Cost-effective solution

Store the excess solar power that is generated throughout the day to then use at night when on-grid power costs are higher.



## Expandable Storage

Start with 5kWh and add extra battery modules in 5kWh steps. Add up to a combined 20kWh of energy storage in a single system.

## No.1 Leading Battery Partner

The Lithium Iron Phosphate cells in AVOL BA5 are produced by CATL - the world leader in Lithium / EV Battery Suppliers.



## Black-out protection

The AVOL Genius can provide you with back-up power during power grid outages, with a max 230VAC load of 4600W.



## Monitor energy production & use

View what you are producing, storing & using with the "SOLARMAN Smart" phone app for both iPhone and Android. Connects to the home WiFi 2.4GHz Network via included dongle.





## Genius Series

### AVOL™ Genius Series: Complete On/Off-grid Energy Storage System

The latest generation of solar energy storage solutions from AVOL™ can deliver scalable energy storage capacities of up to 20kWh for residential homes and buildings. The solution can be set-up as a new PV system with solar battery storage, or retro-fit into an existing PV system.

- 5kW Hybrid Inverter with LFP Battery, and 430W flexible solar panels
- Expand up to 20kWh battery storage
- Built-in customisable energy management
- Mobile app - access anytime, anywhere
- New or retro-fit an existing PV system
- Peak load shifting, battery priority
- Easy set-up and install
- IP65 weather rated
- 5 year product warranty

# Components



## 5kW Hybrid Inverter

The Genius Series: Single Phase 5kW Hybrid Inverter offers flexibility and simplicity in solar-powered system and battery storage installations. The hybrid inverter sends DC electricity generated by solar system directly back to the battery, without additional power conversion or equipment, and has a range of features enable full control over energy management.



## 5.1kWh LFP Battery

The Genius Series: 5.1kWh LFP Battery Pack are modular designed to store and provide energy during the day and night when used with a PV system. Lithium Iron Phosphate Batteries (LiFePO<sub>4</sub> / LFP) used in the Genius Battery pack features longer life span, zero maintenance, ultra-safe, lightweight, improved charge and discharge efficiency.

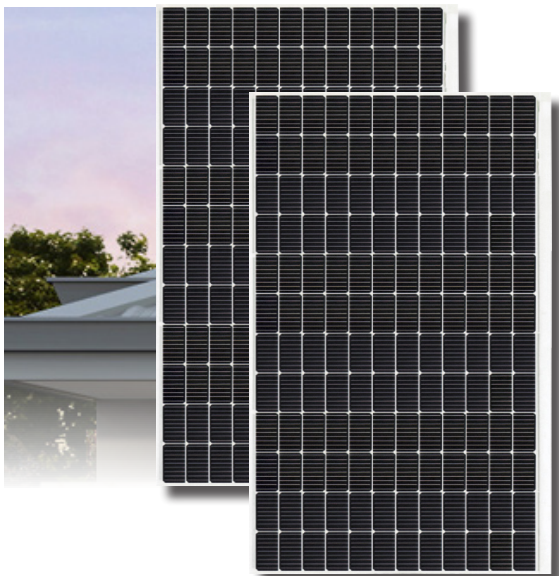

## 430W Flexible Solar Panel



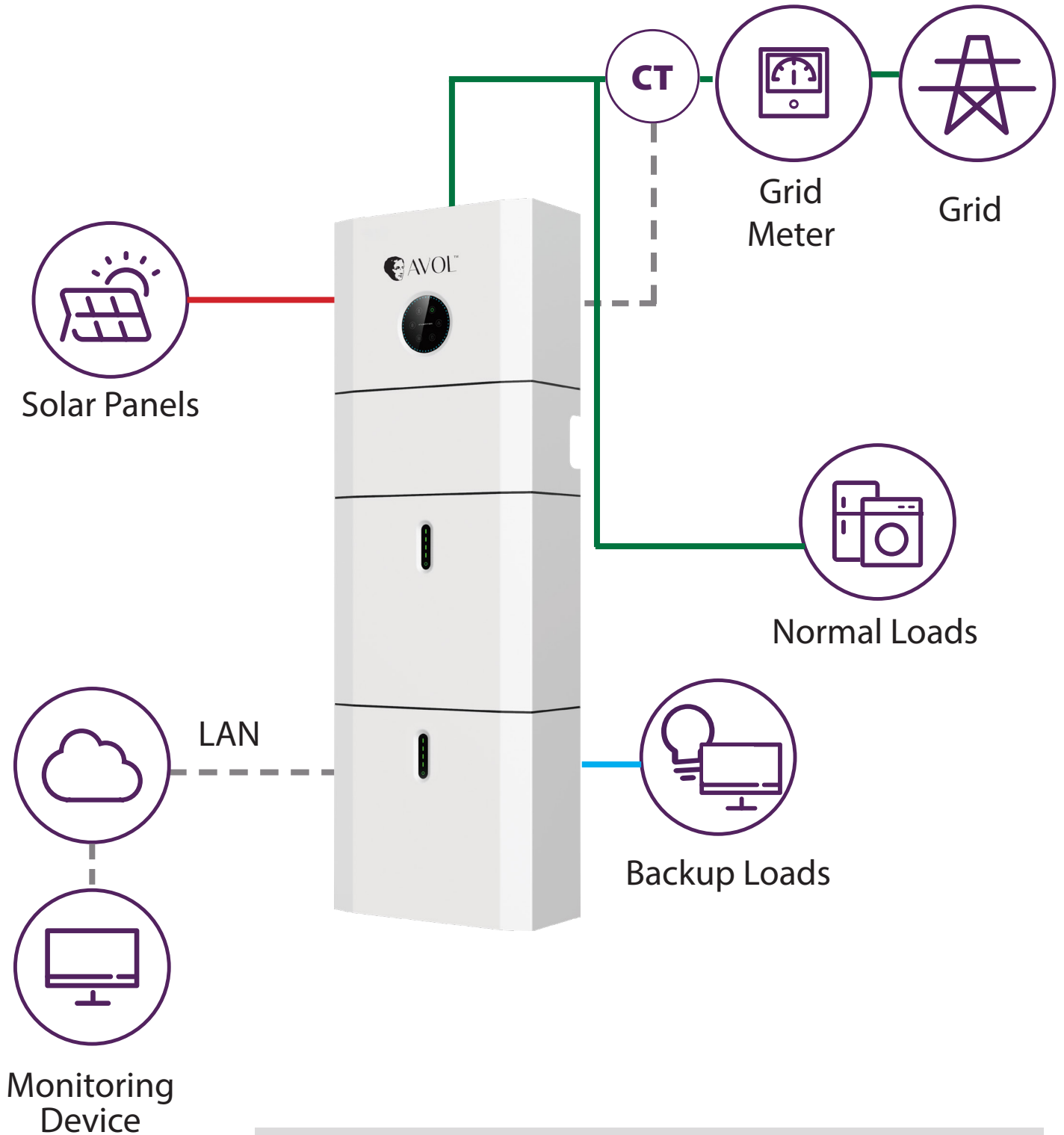

The Genius Series: 430W Flexible Solar Panel is the pinnacle between cutting-edge technology and usability, designed to be durable and more lightweight than traditional solar panels. The solar panels are approved for grid connect making them ideal to be fitted on residential buildings (metal only), motorhomes and other applications.

# Systems Mapping

New System



**Legend**

	DC Power		AC Load (Back-up Power & Standalone)
	AC Grid		Device Communication



Retrofit Systems: Connect battery storage with existing PV system

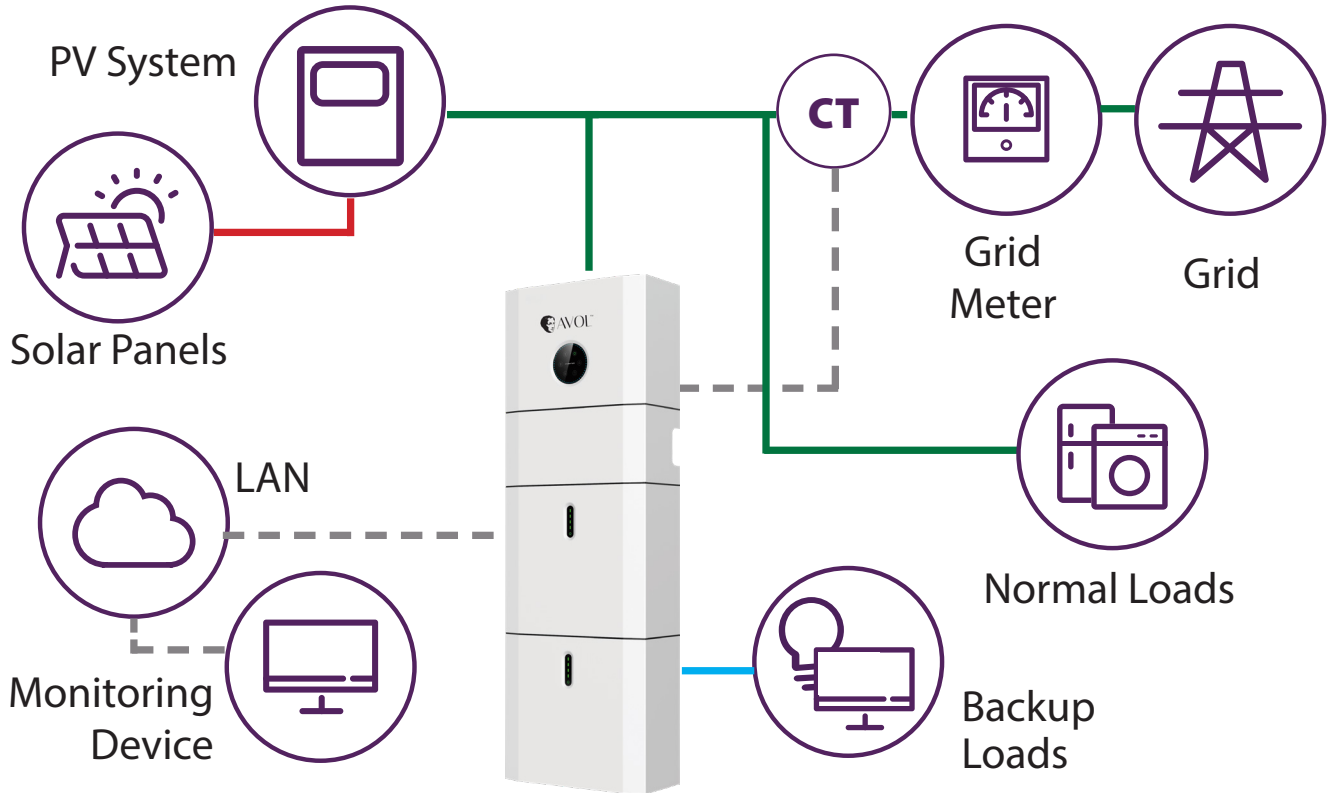

Retrofit Systems: Expand existing PV systems with solar and battery storage

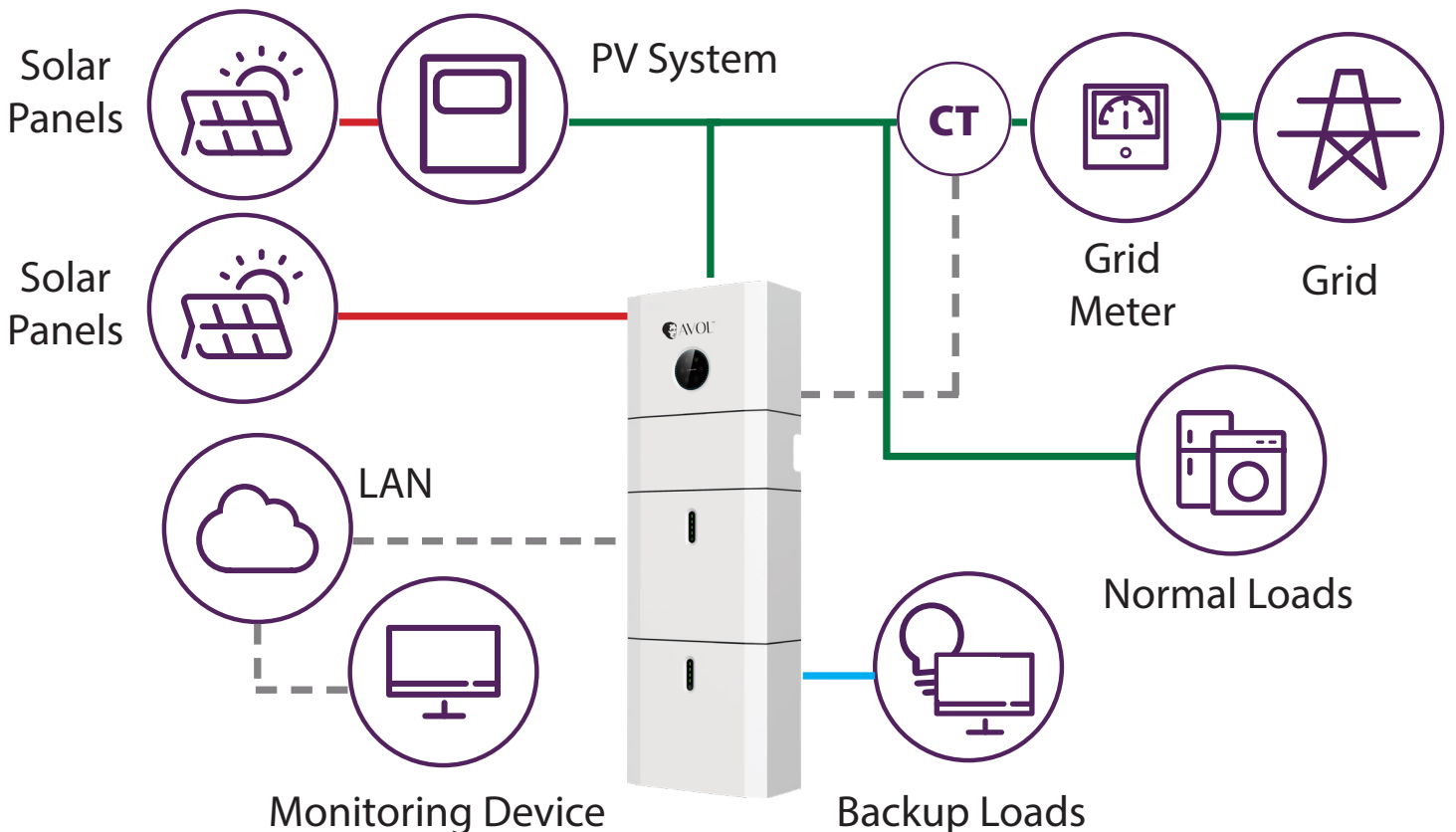

## Off-grid System

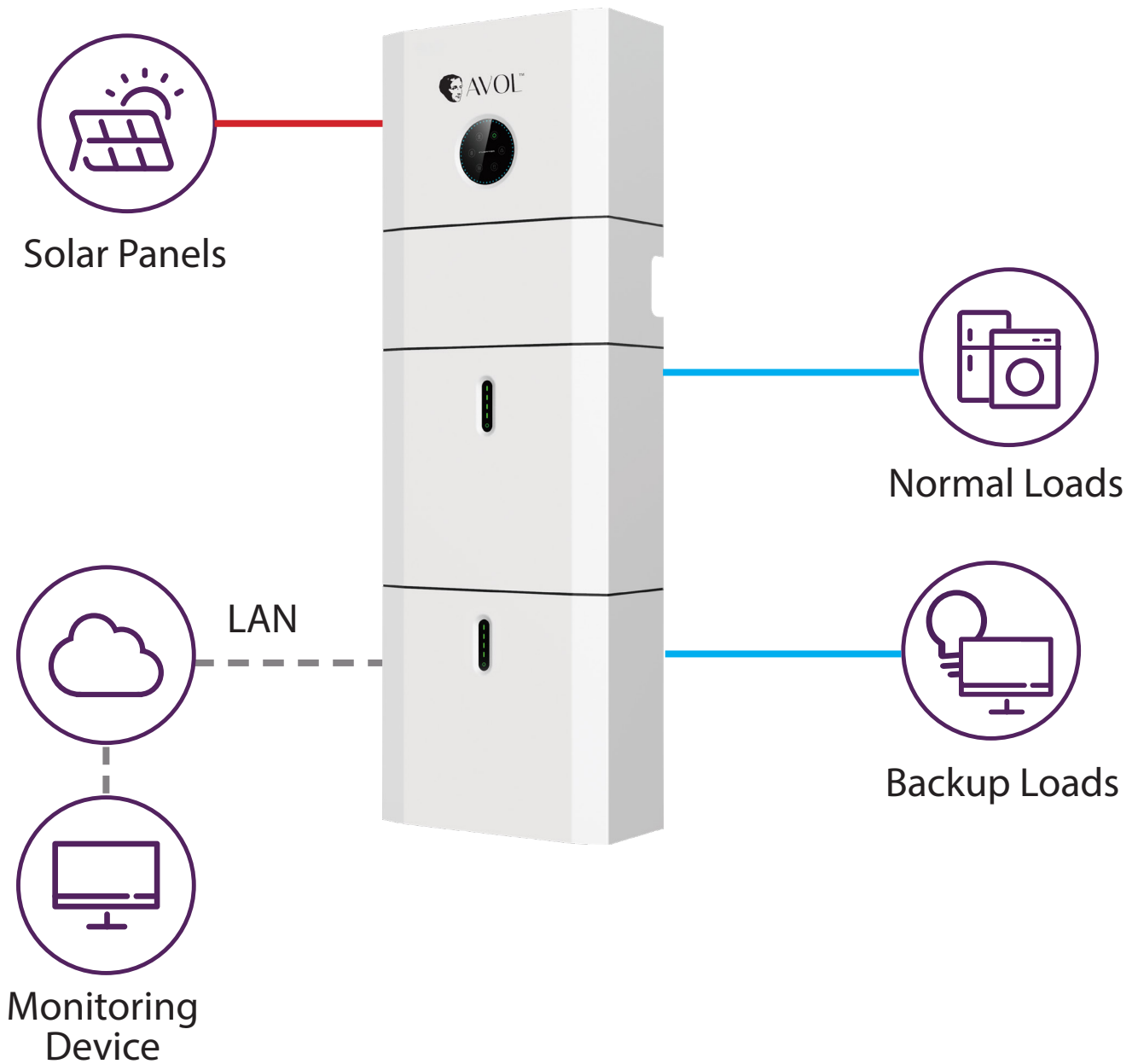

### Legend

— DC Power  
— AC Grid

— AC Load (Back-up Power & Standalone)  
- - - Device Communication

# Operation Modes

The AVOL™ Genius Hybrid Energy Storage solution is equipped with various pre-programmed operational modes, which can be modified to suit the needs and maximise benefits for the end user. Certain operating modes will activate automatically when certain conditions are met, this is done to preserve the system performance.

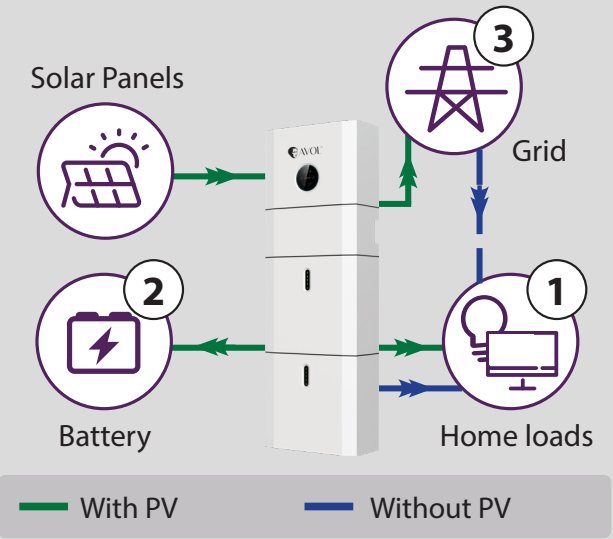

**Self consume mode**

During daylight, system supports home loads, charges battery and feeds excess to power grid. At night, home loads are supported by battery and grid if charge isn't sufficient.

**Self consume mode**

During daylight, system supports home loads, charges battery and feeds excess to power grid. At night, home loads are supported by battery and grid if charge isn't sufficient.

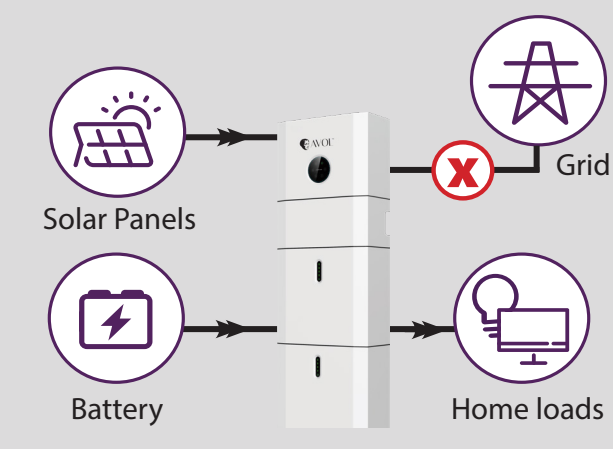

**Battery priority mode**

PV-Battery System is only used as back-up power supply when the grid fails. The battery can be charged with power from a PV system or from the grid.

**Battery priority mode**

PV-Battery System is only used as back-up power supply when the grid fails. The battery can be charged with power from a PV system or from the grid.

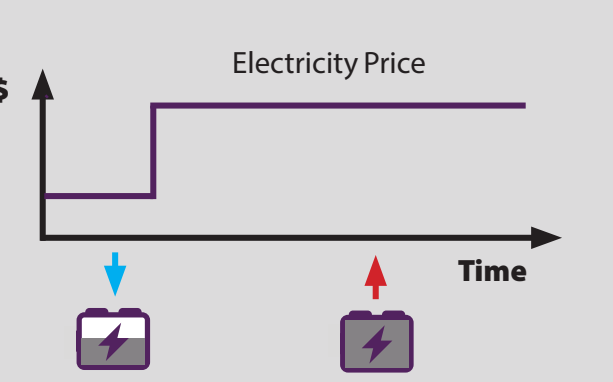

**Peak shift mode**

Accessible through the inverter settings or mobile app. The battery system is charged/discharged at preset times and power-usage to support the grid system.

**Peak shift mode**

Accessible through the inverter settings or mobile app. The battery system is charged/discharged at preset times and power-usage to support the grid system.



# Genius Energy Capacity Selection

In order to receive the maximum benefits from the Genius Series battery storage, an informed selection should be made based on the needs and context of the customer. The intended configuration and mode selection need to be considered, though every situation will differ depending on location and power requirements.

Key considerations for selecting your system:

## **What do I intend to run powered from my battery system?**

- It is important to consider the appliances and essentials that the system is powering. When includes appliances such as fridges, hot water systems, cooking appliances etc.

## **What is my typical daily power consumption?**

- Knowledge of overall power consumption for your home is important for deciding which battery capacities and system modes to use.

## **What size solar system do I need to support the Genius system?**

- The size of the solar array required to support the Genius system will depend on the battery storage selected and the normal loads of the system.

## **What appliances should I assign as backup and normal loads?**

- The Genius Inverter is a hybrid inverter which allows for partial house loads. For economical reasons, appliances such as fridges, lights, some outlets and electrical hot-water systems are prioritized for back-up loads.

## Typical energy demand graph:

The graph below illustrates the typical household power usage throughout a day, as well as average solar generation for a sufficient PV system supplemented with grid power. This matches with the self-consume operation mode of the Genius series.

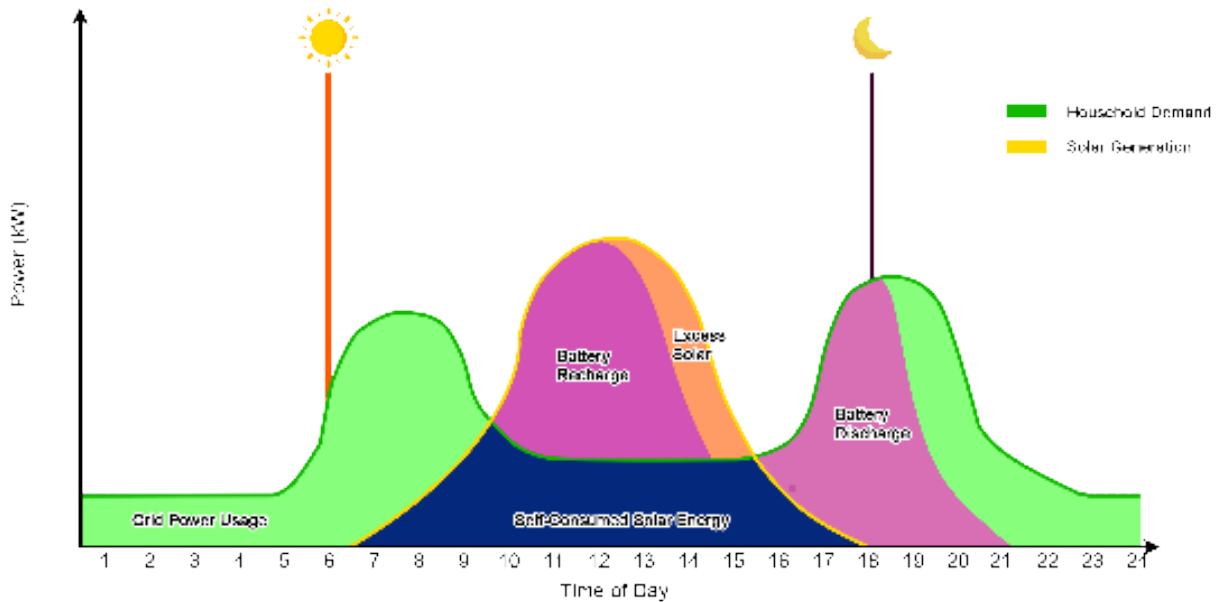

## Typical appliance wattage examples:

Below are examples of average appliance wattages. The left, black wattage is the starting watts. The right, red wattage indicates the running watts. These are useful for simple estimates for the amount of power a household will draw. Wattages will vary based on appliance load.

### Essentials:



LED Lighting  
8W **8W**



Fridge/Freezer  
2200W **700W**



Washing Machine  
2250W **1150W**

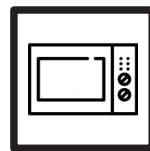

Microwave - 1000W  
1000W **1000W**



Home security system  
500W **500W**

### Optionals:



65" Television  
170W **170W**



Desktop Setup  
600W **600W**



Game Console  
350W **350W**



Wi-Fi Router  
10W **10W**

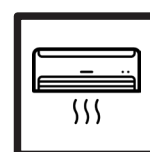

Central AC- 20,000 BTU  
3300W **2500W**

### Luxuries:



Electric Water Heater  
4000W **4000W**



Bathroom Heated Flooring  
1200W **1200W**



Swimming pool Heat pump  
4500W **4700W**



Garage Door Opener  
1100W **550W**

## Daily consumption for typical households:

To make an informed decision about the Genius model selected, it is helpful to relate your situation to a common scenario. The table below details a few common scenarios, which will be elaborated on in the next section:

Household	Size	Occupants	Appliance Usage	Power Usage
A	Double-story 3-bedroom	4	Essentials + Optionals + Luxuries	35kW/per day
B	Single-story 2-bedroom	2	Essentials + Optionals	20kW/ per day
C	Single-story 1-bedroom	1	Essentials	15 kW/ per day

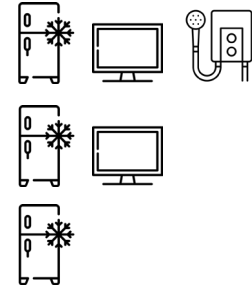

## Battery + Mode Selection for typical households

### Household A:

- Household A has high daily power usage requirements, and would therefore benefit from a larger capacity battery, such as the 15kW or 20kW Genius Kits. Any of the available modes will suit this household, as long as grid power is available.
- As the power requirement is too high to maintain operation for an entire day, self-consume mode will maximize savings and utilize the battery effectively.



## Household B:

- Household B has average daily power usage requirements, and would therefore benefit differently from both low and high capacity kits. A higher capacity 15kW or 20kW kit will allow for higher savings and potential for off-grid living with a sufficient PV system. Battery priority mode will provide efficient power for a period of time in the case of grid failure.
- Smaller capacities, such as the Genius 5 and 10kW kits can be utilized in peak-shift mode to increase savings.

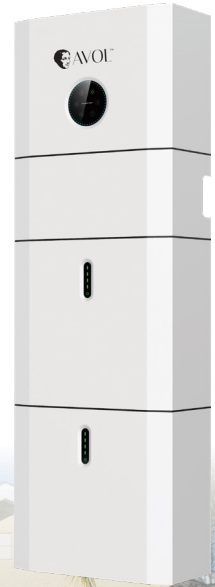

## Household C:

- Household C has relatively low daily power usage, and can potentially run off-grid with a high capacity kit and a sufficient PV system. Smaller capacity kits will work well with this household in self-consume and battery priority modes when operating connected to the grid.

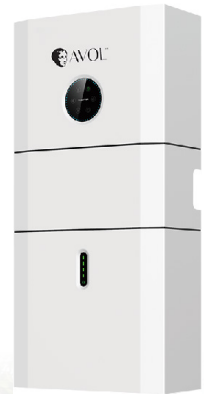

# Genius Hybrid Energy Storage

Deliver scalable energy storage capacities of up to 20kWh for residential homes and buildings. The solution can be set-up as a new PV system with solar battery storage, or retro-fit in an existing PV system.

- Ideal for residential & small commercial businesses - fit kits with your own solar panels
- Convert the current PV system to include battery energy storage of up to 20kWh
- Each kit includes installation accessories necessary.

## AVOL Battery Storage Kits

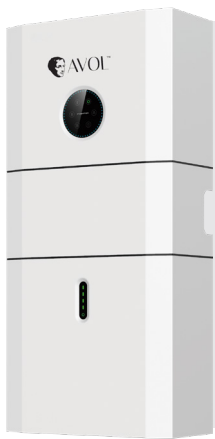

### Genius5

5kWh Battery Storage

The kit includes:

- 1 x 5kW Hybrid Inverter
- 1 x 5.1kWh LFP Battery

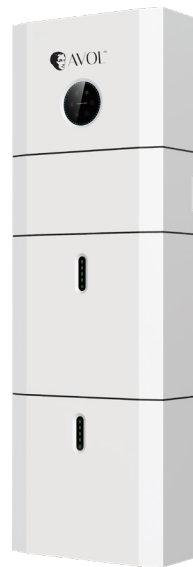

### Genius10

10kWh Battery Storage

The kit includes:

- 1 x 5kW Hybrid Inverter
- 2 x 5.1kWh LFP Battery



### Genius15

15kWh Battery Storage

The kit includes:

- 1 x 5kW Hybrid Inverter
- 3 x 5.1kWh LFP Battery

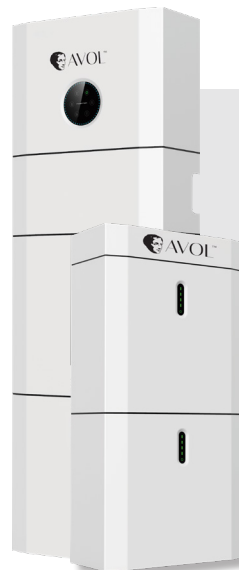

### Genius20

20kWh Battery Storage

The kit includes:

- 1 x 5kW Hybrid Inverter
- 4 x 5.1kWh LFP Battery



# Genius Complete Kit

With its comprehensive solution, the AVOL Genius + Solar range of systems can provide power during a power outage (up to 20kWh battery storage) and also offer a range of benefits, including a 5 year warranty and simple installation.

## Genius + Solar 3kW Kits

- Generates 3800kWh per year
- Suitable for smaller households (1-2 ppl)
- Perfect for use as a dedicated backup system

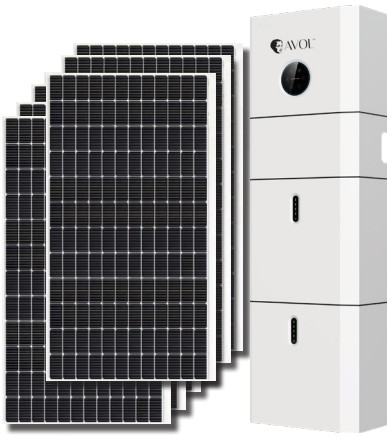

## Genius5, Genius10 + Solar

5 or 10 kWh Battery Storage + 3kW Solar Panels

### PWRSLR-P3I5B5, PWRSLR-P3I5B10

The kit includes:

- 1 x 5kW Hybrid Inverter
- 1-2 x 5.1kWh LFP Battery
- 7 x 430W Flexible Solar Panels

## Genius + Solar 6kW Kits

- Generates 7600kWh per year
- Suitable for larger households (3+ People)
- Perfect for use with self-consumption modes, off-grid living possible



## Genius15, Genius20 + Solar

15 or 20 kWh Battery Storage + 6kW Solar Panels

### PWRSLR-P3I5B15, PWRSLR-P3I5B20

The kit includes:

- 1 x 5kW Hybrid Inverter
- 3-4 x 5.1kWh LFP Battery
- 14 x 430W Flexible Solar Panels

## Accessories

Product	Product Number
Connection Kit	AVOL-GENIUS-EXP0510 (10kWh) / -EXP0520 (20kWh)
DC Isolator	SLR-DCISO-1000V
DC Isolator Cover	SLR-DCISOCOV
MC4 Connector	SLR-CON-MC4
100M Dual Core Solar Cable	SLR-CBL4.6MM



# Reliable PV energy for home and business

## Genius Series: Ultra-lightweight and flexible 430W mono-crystalline solar panels

The Genius Series: 430W Flexible Solar Panel is the pinnacle between cutting-edge technology and usability, designed to be durable and more lightweight than traditional solar panels. The solar panels are approved for grid connect making them ideal to be fitted on residential buildings (metal only), motor-homes and other applications.

- Lightweight mono-crystalline modules
- Quick bonding - requires no penetration
- High bond double-sided adhesive tape
- Wind speed & wind load rating: 24000 Pa
- Power output range: 425-430W
- Easy transportation and install - 7.3kgs
- Clean Energy Council (CEC) accredited
- 5 year warranty



**Home & Business Ready**

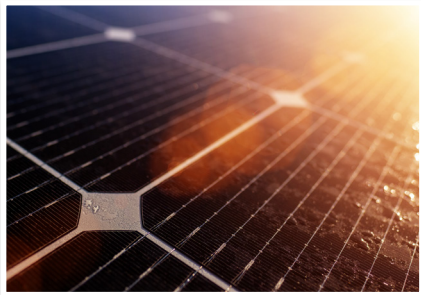

**Adhesive Mounting Solution**



**Lightweight & Durable**

## Series Specifications

Model		SLR-SP430W
Series Name	Genius Series: 430W Flexible Solar Panel	
<b>General</b>		
Type	Monocrystalline silicon (166mm half cell)	
Number of cells	144 (12x12)	
Dimensions	2054 x 1093 x 2mm	
Weight	7.3kg	
Operating Environment	-40 °C to 85 °C	
Back-sheet	White	
Frame	Frameless	
Junction box	IP 68 rated	
Output Cables	Photovoltaic technology cable 4.0 mm <sup>2</sup> , (+)150 / (-)450 mm	
Connector	MC4 compatible	
Manufacturer Country	China	
<b>Electrical</b>		
Maximum Wattage Output	430W	
Maximum Power Voltage (Vmp)	42.0	
Maximum Power Current (Imp)	10.24	
Open-circuit Voltage (Voc)	49.8	
Short-circuit Current (Isc)	10.74	
Module Efficiency	19.2%	
Max. System Voltage	1000 V DC (IEC)	
Max. Series Fuse Rating	20 A	
Application Class	Class A	
Power Tolerance	0/+5 W	
<b>Product Detail</b>		

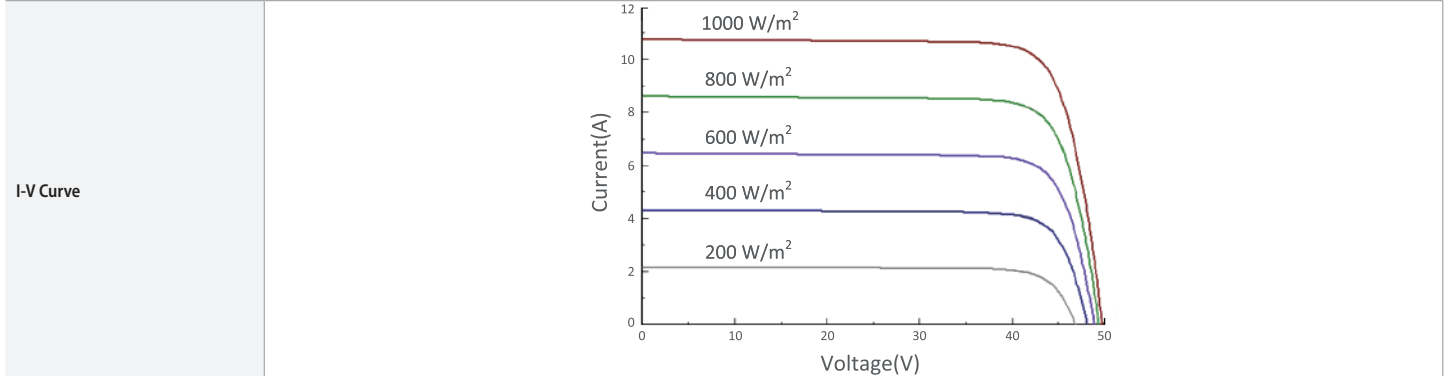
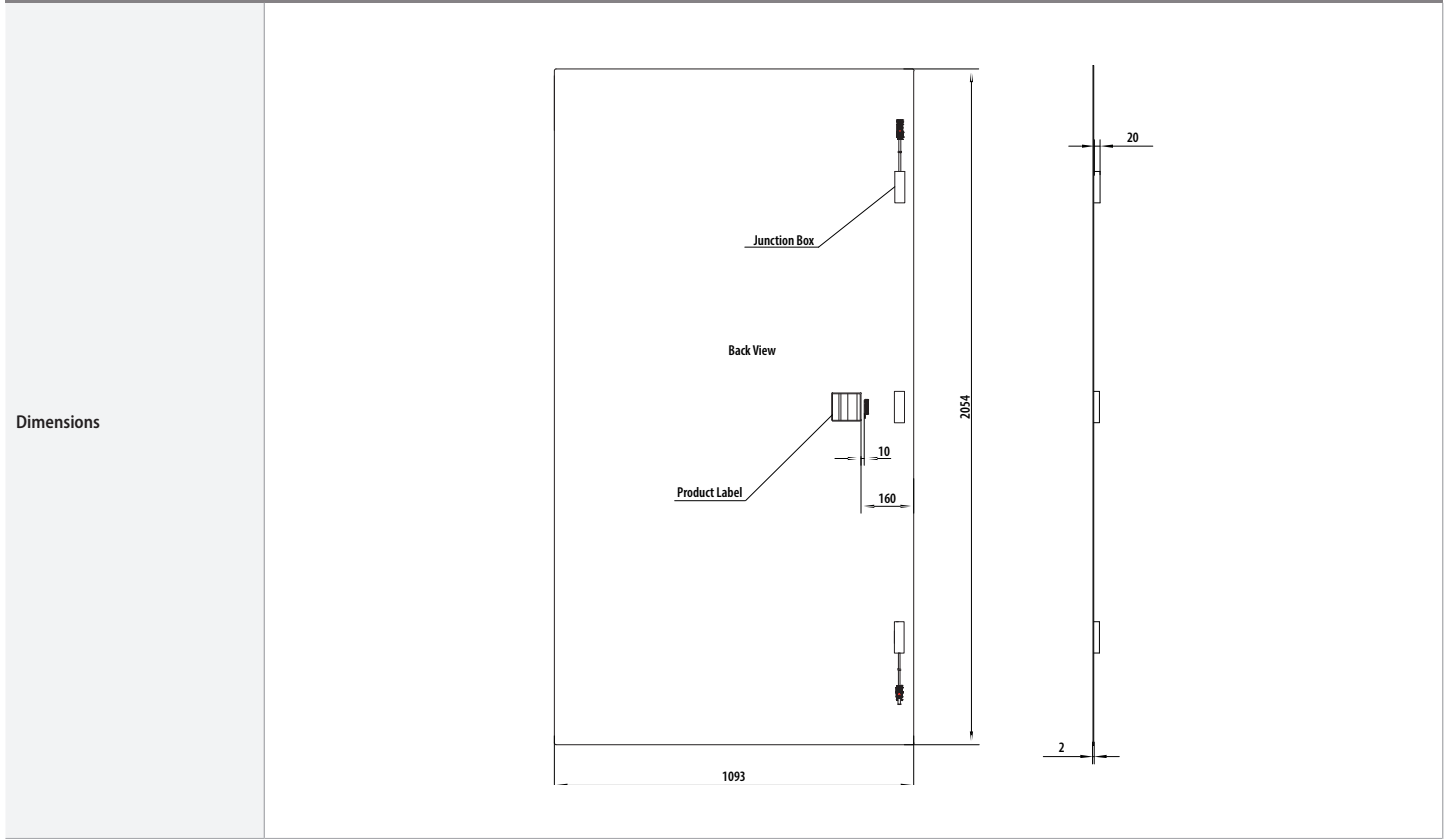



# Advanced energy management simplified

## Genius Series: Single Phase 5kW Hybrid Inverter

The Genius Series: Single Phase 5kW Hybrid Inverter offers flexibility and simplicity in solar-powered systems and battery storage installations. The hybrid inverter sends DC electricity generated by solar system directly back to the battery, without additional power conversion or equipment, and has a range of features enable full control over energy management.

- Built-in customised energy management modes (on-grid / off-grid)
- Connects solar energy to household & feeds back into grid
- Power output: 5000W
- High maximum efficiency: 97.6%
- Dual MPPT's for higher energy harvest
- Remote access - mobile app available



**Compatible with BYO Solar Installs**



**Smart Remote Access**



**Redirect energy to the grid**

## Series Specifications

Model	AVOL-GENIUS-IA5
<b>Series Name</b>	Genius Series: 5kW Hybrid Solar Power Inverter
<b>DC Input</b>	
Input Start Up Voltage	150V
Minimum Input DC Operating Voltage	150V
Maximum DC Voltage	580V
Maximum Input PV Power	6500W
Nominal Voltage	400V
MPPT Voltage Range	80V - 560V
Number of MPP Tracker	2
Maximum Input Current Per MPPT	15A
Maximum Short Circuit Current Per MPPT	18A
<b>AC Output (Grid)</b>	
Nominal AC Output Power	5000W
Maximum AC Apparent Power	360VA (from grid)
Maximum AC Output Power	4999W (Australia)
Nominal AC Voltage	230VAC
Max. Output Current	21.7A (Australia)
Max. Input Current	32A
THD	<3% at rated power
<b>Battery Input</b>	
Battery Type	LFP (LiFePO4)
Nominal Battery Voltage Charging Voltage	48V
Range	40-60V
Maximum Charge / Discharge Current	100A
Battery Capacity	100-400Ah
Charging Strategy for Li-ion Battery	Dependant on the BMS
<b>AC Output (Backup)</b>	
Max. Output Apparent Power	5000VA
Max. Output Current	20A
Nominal Output Voltage	230V
Nominal Output Frequency	50/60Hz
Output THD	<3% (Linear Load)
<b>Efficiency</b>	
Max. PV Efficiency	97.6%
Euro. PV Efficiency	97.0%
<b>Protection</b>	
DC Switch	Bipolar DC Switch (125A/Pole)
Anti-islanding Protection	Yes
Output Over Current	Yes
DC Reverse Polarity Protection	Yes
String Fault Detection	Yes
AC/DC Surge Protection	DC Type II; AC Type III
Insulation Detection	Yes
AC Short Circuit Protection	Yes
<b>General</b>	
Dimensions	540 x 590 x 240mm
Weight	32kg
Operating Environment	-25° C~ +60° C
Noise (dB)	<25
Cooling Type	Natural Convection
Max. Operation Altitude	2000m
Operation Humidity	0~95% (No Condensation)
IP Class	IP65
Topology	Battery Isolation
Communication	RS485/CAN2.0/WIFI/4G
Display	LCD/APP
Warranty	5 Years
Manufacturer Country	China
Certification & Standard	IEC/EN 62109-1&2; IEC/EN61000-6-1; IEC/EN61000-6-2; EN61000-6-3; IEC/EN61000-6-4; IEC/EN61000-3-11; EN61000-3-12; IEC60529; IEC60068; IEC61683; IEC62116; IEC61727; EN50549-1; AS 4777.2; NRS 097; VDE-AR-N-4105; CEI0-21; G98; G99; C10/C11



# Up to 20kWh scalable battery solution

## Genius Series: 5.1kWh LFP Battery Pack

The Genius Series: 5.1kWh LFP Battery Packs are modular designed to store and provide energy during the day and night when used with a PV system. Lithium Iron Phosphate Batteries (LiFePO<sub>4</sub> / LFP) used in the Genius Battery pack features longer life span, zero maintenance, ultra-safe, lightweight, improved charge and discharge efficiency.

- Modular, robust design delivers excellent levels of safety and performance
- Cells produced by the world's industry leading partner Contemporary Amperex Technology Co., Limited
- Up to 4 modules in a single PV system
- Up to 20kWh of energy storage
- 10,000 cycles at 90% depth of discharge
- IP65 weather rated, 5 year warranty

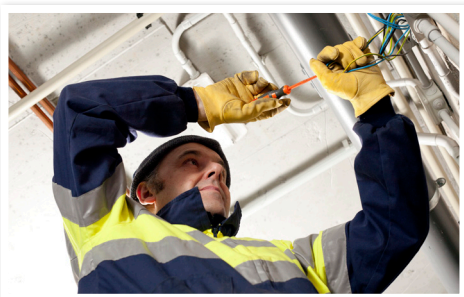

Simple Installation



Long-lasting energy storage



High quality CATL cells

## Series Specifications

Model	AVOL-GENIUS-BA5
Series Name	Genius Series: 5.1kWh LFP Battery Pack
<b>General</b>	
Battery type	Lithium Iron Phosphate (LiFePO4 / LFP)
Weight	54kg
Dimension	540 x 490 x 240mm
IP Protection	IP65
Warranty	5 Years
Manufacturer Country	China
<b>Electrical</b>	
Energy Capacity	5.12kWh
Usable Capacity	4.6kWh
Depth of Discharge (DoD)	90%
Nominal Voltage	51.2V
DC Circuit Breaker	125A
Operating Voltage Range	44.8-56.5V
Internal Resistance	<20mΩ
Cycle Life	10,000 cycle
<b>Operation</b>	
Maximum Charge / Discharge Current	50N80A
Rated DC power	4096W
Max. Charge / Discharge Power	2825W / 4096W
Operating Temperature Range	0 to 50°C charging / -10 to 50°C discharging
Humidity	0~95% (No condensation)
<b>BMS</b>	
Modules Connection	Max.4
Capacity	100-400Ah
Power Consumption	<2W
Communication	CAN & RS485
Monitoring Parameters	System voltage, current, cell voltage, cell temperature, PCBA temperature measurement
<b>Certificate</b>	
Safety(Cell)	Pack: IEC/EN 62619;UN38.3 Cell: IEC/EN 62619;UN38.3;UL 1973

\* Maximum 4 battery pack in parallel.

### Wiring Diagram:

In accordance with Australian safety regulations, the neutral cables of the on-grid side and the back-up side must be connected together, otherwise the back-up function will not work.

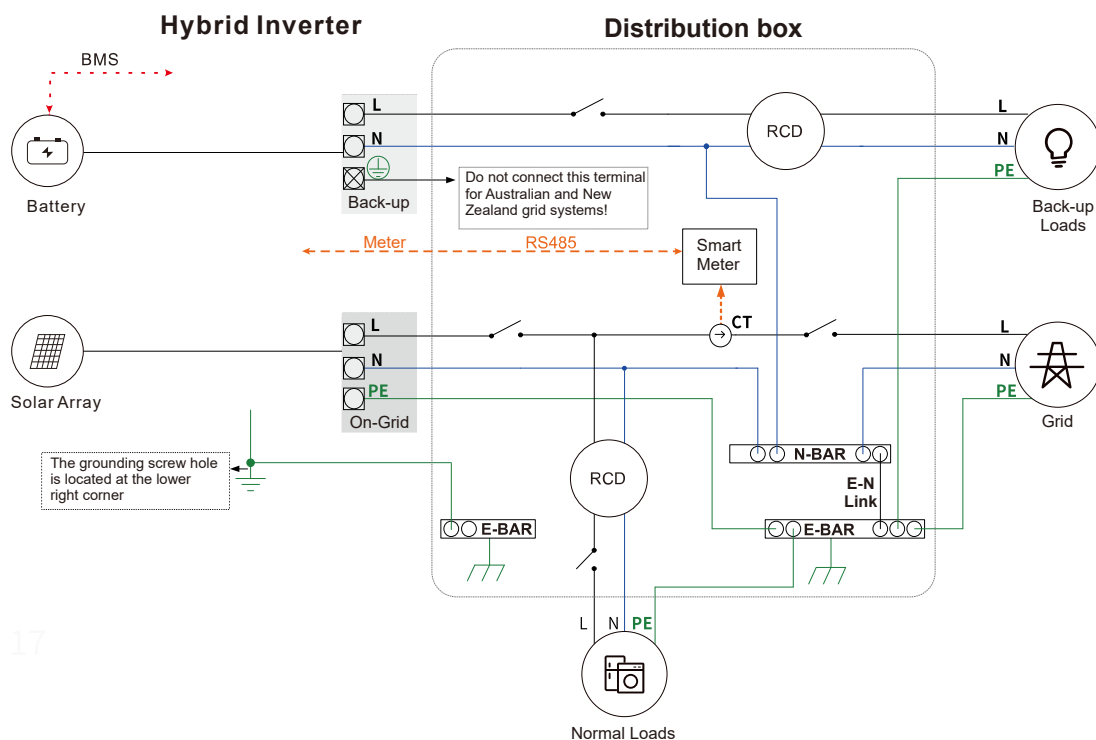



# AVOL

The genius of electricity

Contact your local AVOL reseller:

[www.avol.technology](http://www.avol.technology)

