

HEARTSTART FRx DEFIBRILLATOR

OWNER'S MANUAL

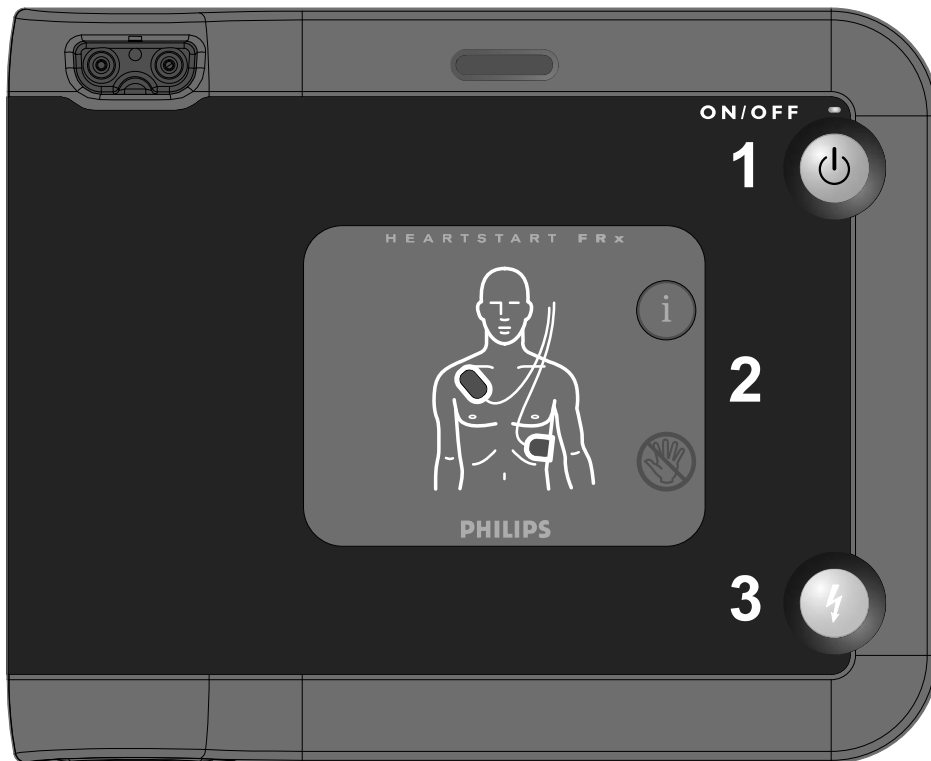

861304
Edition 13

PHILIPS

AED Professionals™

Distributed by AED Professionals - A General Medical Devices, Inc. Company
348 W. Cofax St. Palatine, IL 60067 • 888-541-2337 • www.AEDProfessionals.com

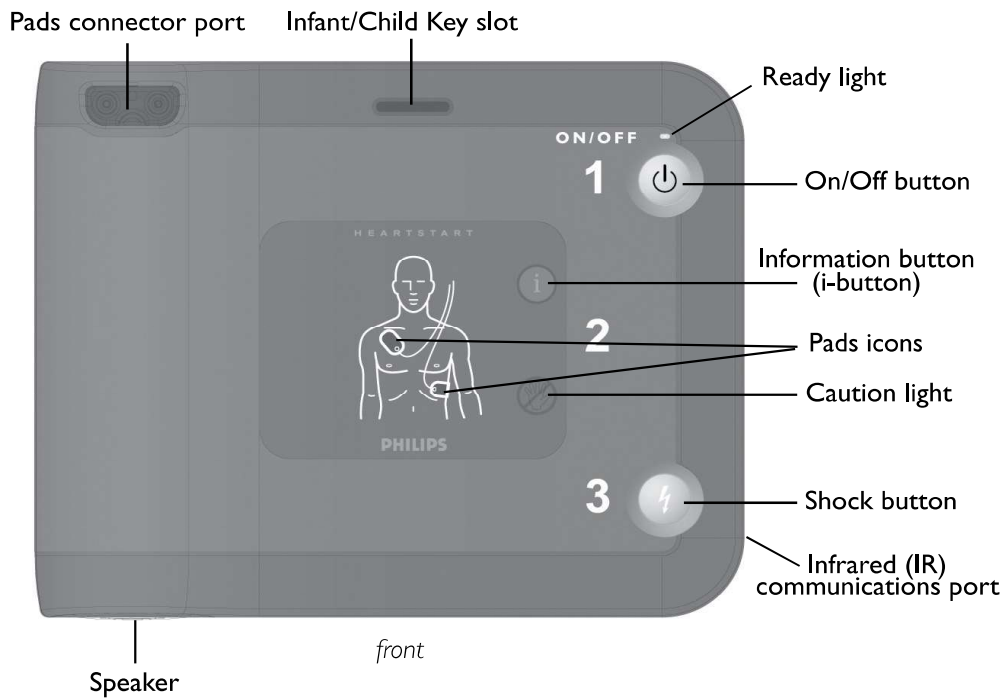
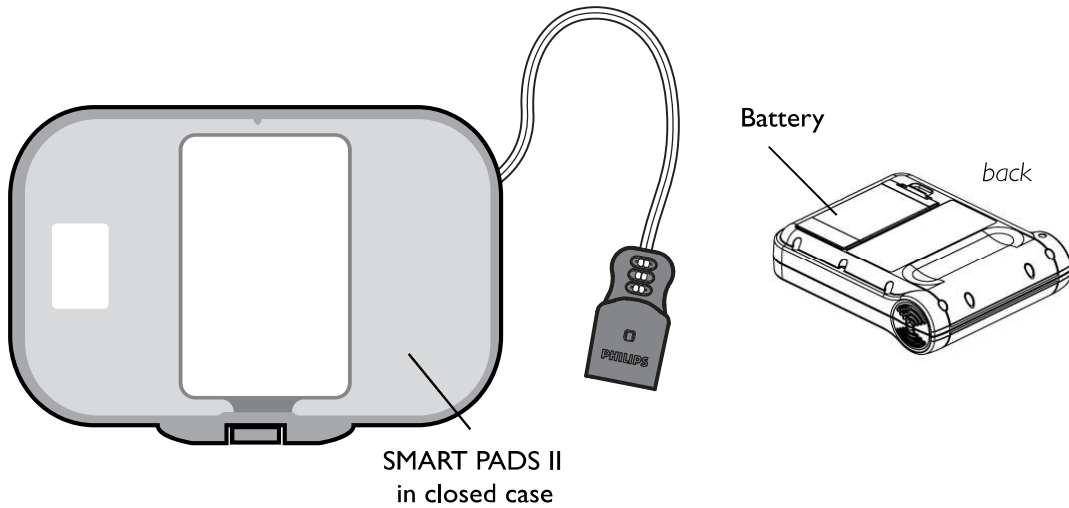

The HeartStart FRx Defibrillator 861304

HeartStart FRx Defibrillator QUICK REFERENCE

PHILIPS MEDICAL SYSTEMS

Check for signs of Sudden Cardiac Arrest:
 Unresponsive Not Breathing Normally

1 **TURN ON**

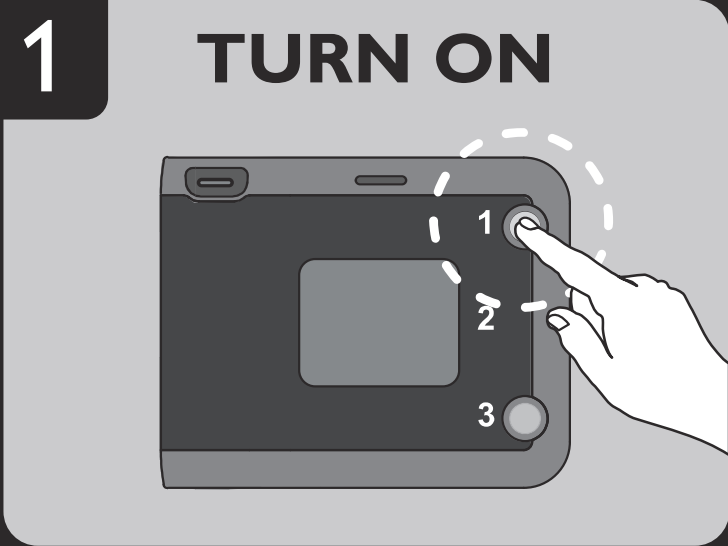

2 **PLACE PADS**



3 **PRESS SHOCK**



AED  **Professionals™**

Distributed by AED Professionals - A General Medical Devices, Inc. Company
348 W. Cofax St. Palatine, IL 60067 • 888-541-2337 • www.AEDProfessionals.com

HeartStart FRx

861304

Automated External Defibrillator

OWNER'S MANUAL

Edition 13

IMPORTANT NOTE:

It is important to understand that survival rates for sudden cardiac arrest are directly related to how soon victims receive treatment. For every minute of delay, the chance of survival declines by 7% to 10%.

Treatment cannot assure survival. In some victims, the underlying problem causing the cardiac arrest is simply not survivable despite any available care.

PHILIPS

About This Edition

The information in this guide applies to the HeartStart FRx Defibrillator 861304. This information is subject to change. Please contact Philips at www.philips.com/productdocs or your local Philips representative for information on revisions.

Edition History

Edition 13

Publication date: March 2015

Publication number: 453564544111

Notices

© 2015 Koninklijke Philips N.V.
All rights reserved.

Specifications are subject to change without notice.

Trademarks are the property of Koninklijke Philips N.V. or their respective owners.

Authorized EU Representative

Philips Medizin Systeme Boeblingen GmbH
Hewlett-Packard Strasse 2
71034 Boeblingen, Germany
(+49) 7031 463-2254

CAUTION: Federal law (USA) restricts this device to sale by or on the order of a physician.

The Philips HeartStart FRx is designed to be used only with Philips-approved accessories. The FRx may perform improperly if non-approved accessories are used.

Device Tracking

In the USA, this device is subject to tracking requirements by the manufacturer and distributors. If the defibrillator has been sold, donated, lost, stolen, exported, or destroyed, notify Philips Medical Systems or your distributor.

Device Manufacturer

Philips Medical Systems,
22100 Bothell Everett Highway
Bothell, WA, 98021-8431, USA

Patents

This product is manufactured and sold under one or more of the following United States patents: U.S. Pat. No US5591213, US5601612, US5607454, US5611815, US5617853, US5632280, US5650750, US5735879, US5749905, US5773961, US5776166, US5800460, US5803927, US5868792, US5879374, US5889388, US5891046, US5891049, US5899926, US5902249, US5904707, US5951598, US5967817, US6016059, US6047212, US6075369, US6185458, US6230054, US6234816, US6272385, US6287328, US6299574, US6317635, US6319031, US6346014, US6350160, US6356785, US6441582, US6553257, US6556864, US6662056, US6871093, US7016726, US7463922, US7715913, US7822488, US8209008, US8335562, USRE43050, USD678532, and other patents pending.

For Technical Support

If you need technical support, please contact your local Philips representative by calling the regional number on the back cover of this manual, or go to www.philips.com/AEDsupport.

To download additional copies of this manual, go to www.philips.com/productdocs.

CONTENTS

| | | |
|---|--|----|
| 1 | INTRODUCTION TO THE HEARTSTART FRX | |
| | Description | 1 |
| | Sudden cardiac arrest | 1 |
| | Indications for use | 1 |
| | Implementation considerations | 2 |
| | For more information | 2 |
| 2 | SETTING UP THE HEARTSTART FRX | |
| | Package contents | 3 |
| | Setting up the FRx | 3 |
| | Recommended accessories | 6 |
| 3 | USING THE HEARTSTART FRX | |
| | Overview | 7 |
| | STEP 1: Press the green on/off button | 8 |
| | STEP 2: Follow the FRx’s voice instructions | 8 |
| | STEP 3: Press the flashing orange Shock button if instructed | 9 |
| | Treating infants and children | 10 |
| | When emergency medical services arrive | 12 |
| 4 | AFTER USING THE HEARTSTART FRX | |
| | After each use | 15 |
| | FRx data storage | 16 |
| 5 | MAINTAINING THE HEARTSTART FRX | |
| | Routine maintenance | 19 |
| | Periodic checks | 19 |
| | Cleaning the FRx | 20 |
| | Disposing of the FRx | 20 |
| | Ready light troubleshooting tips | 20 |
| | Troubleshooting a chirping HeartStart | 21 |

APPENDICES

A Accessories 23

B Glossary of terms 25

C Glossary of symbols/controls 29

D Warnings and Precautions 33

E Technical information 35

F Configuration 43

G Testing and troubleshooting 49

H Additional technical data required for European conformity 55

I INTRODUCTION TO THE HEARTSTART FRX

DESCRIPTION

The Philips HeartStart FRx Defibrillator 861304 (“FRx”) is an automated external defibrillator (AED). Small, lightweight, rugged, and battery powered, it is designed for simple and reliable operation by minimally trained users. The FRx is highly configurable for local protocol considerations.*

SUDDEN CARDIAC ARREST

The FRx is used to treat ventricular fibrillation (VF), a common cause of sudden cardiac arrest (SCA), and certain ventricular tachycardias (VTs). SCA is a condition that occurs when the heart unexpectedly stops pumping. SCA can occur to anyone – young or old, male or female – anywhere, at any time. Many victims of SCA do not have warning signs or symptoms. Some people may have a higher risk for SCA than others. Causes vary and may be different for infants and children than for adults.

VF is a chaotic quivering of the heart muscle that prevents it from pumping blood. The only effective treatment for VF is defibrillation. The FRx treats VF by sending a shock across the heart, so it can start beating regularly again. Unless this is successful within the first few minutes after the heart stops beating, the victim is not likely to survive.

INDICATIONS FOR USE

The FRx should be used to treat someone you think may be a victim of SCA.

A person in SCA:

- does not respond when shaken, and
- is not breathing normally.

If in doubt, apply the pads. Follow the voice instructions for each step in using the defibrillator.

* Configurability includes timing of the “Call Emergency Medical Services” reminder, CPR protocol variations, and other features. See Appendix F, “Configuration,” for details.

IMPLEMENTATION CONSIDERATIONS

Check with your local health department to see if there are any national or local requirements about owning and using a defibrillator. The FRx AED is one part of a well-designed emergency response plan. Recognized resuscitation councils recommend that emergency response plans include physician oversight and training in cardiopulmonary resuscitation (CPR).

Several national and local organizations offer combined CPR/AED training. Philips recommends that you train on the device you will be using. Contact your Philips representative for information, or visit us online at www.philips.com/AEDservices to learn about certified training and web-based refresher training (offered in select areas) available through Philips AED Services.

NOTE: Training accessories are available for practicing use of the AED. See Appendix A for information.

FOR MORE INFORMATION

Contact your local Philips distributor for additional information about the FRx. We will be happy to answer any questions you may have and to provide you with copies of the clinical summaries of several key studies using Philips automated external defibrillators.*

Technical information about all Philips HeartStart automated external defibrillators is also available online at www.philips.com/productdocs, in the *Technical Reference Manuals* for HeartStart Automated External Defibrillators.

* Clinical summaries also include defibrillators sold as ForeRunner and FR2.

2 SETTING UP THE HEARTSTART FRX

PACKAGE CONTENTS

Check the contents of the FRx box to be sure it contains:

- 1 HeartStart FRx Defibrillator
- 1 four-year battery M5070A,* pre-installed
- 1 package of HeartStart SMART Pads II 989803139261, containing one set of adhesive defibrillation pads in a disposable plastic case, pre-installed
- 1 Quick Reference Guide
- 1 Owner's Manual
- 1 HeartStart Quick Setup Guide
- 1 inspection log/maintenance booklet with plastic storage sleeve and maintenance tags†

IMPORTANT NOTE: The FRx is designed to be used with a carry case. A number of carry cases are offered to meet the needs of your individual defibrillation program. These include a standard carry case and a hard-shell carry case. See Appendix A for information about these as well as a list of training materials and other accessories available from Philips.

If you have purchased the FRx Ready-Pack configuration, the FRx is installed in an FRx carry case, which also contains a spare SMART Pads case.

SETTING UP THE FRX

Setting up the FRx is simple and quick. The Quick Setup Guide provides illustrated instructions for setting up the FRx, described in detail below.

- I. Remove the FRx from its packaging. Check that the battery and SMART Pads are installed.‡

* The FRx sold for aviation applications includes a TSO-certified battery, REF: 989803139301, instead of the M5070A.

† In Japan, the defibrillator comes with a different style of booklet and maintenance tag.

‡ If the battery and pads are not installed, follow the directions in Chapter 4, "After Using the HeartStart FRx" to install the pads and battery.

NOTE: To prevent the pads' adhesive gel from drying out, do not open the pads case until you need to use the pads.

2. Pull out and discard the green Setup tab.
3. The FRx will automatically run a self-test. Press the Shock button and the On/Off button when instructed. Be sure to let the self-test run all the way to completion. When the self-test is over, the FRx will report the result, and tell you to push the green On/Off button in case of an emergency. (*Do not push the green button unless this is an actual emergency.*) Then the FRx will turn off and go to standby mode.* The green Ready light will be blinking to show the FRx is ready for use.

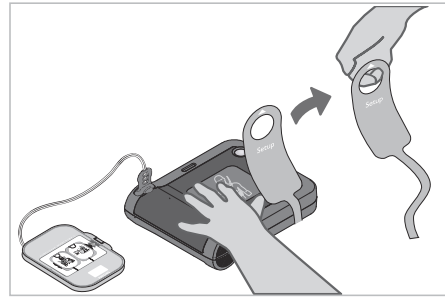

4. Install the FRx in its carry case, if it is not pre-installed. Check that the Quick Reference Guide[†] is face up in the clear plastic window on the inside of the carry case. Philips recommends that you store a spare pads case and spare battery with your FRx. If you are using an FRx carry case, there is an area in the lid of the case, under the flap, to store a spare package of pads and a spare battery.[‡]

NOTE: Do not store anything in the defibrillator carry case that it is not designed to accommodate. Store all objects in their intended location in the case.

- * As long as a battery is installed, turning the FRx “off” puts it into standby mode, which means that it is ready for use.
- † The illustration on the cover of the Quick Reference Guide is a 3-step guide to using the FRx. Detailed illustrated directions are inside, for reference in an emergency, or if you are hearing impaired or using the FRx where it is hard to hear the voice instructions. Any of the carry case options has room for storing the Quick Reference Guide.
- ‡ See Chapter 4, “After Using the HeartStart FRx” for directions on how to replace the battery in the FRx.

- Use the maintenance tag provided to record the expiration date of the installed pads. If you have a spare pads case and spare battery, record the pads expiration date and battery install-by date on the maintenance tag.*

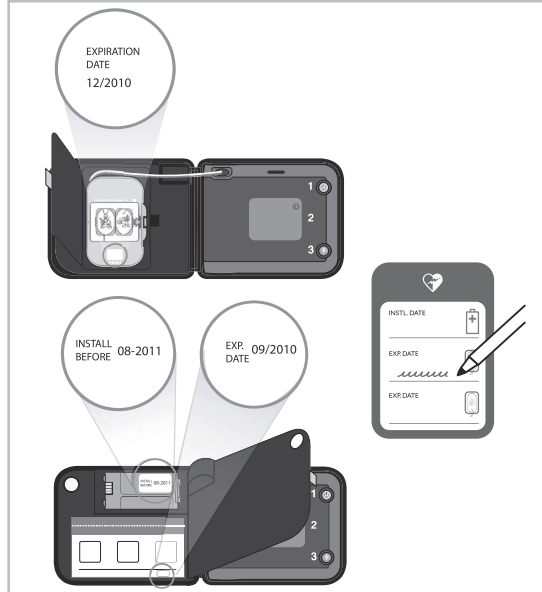

- The maintenance tag and maintenance booklet should be kept with your HeartStart. Adhere the plastic storage sleeve for the booklet to the AED wall mount or cabinet and place the booklet in it.*

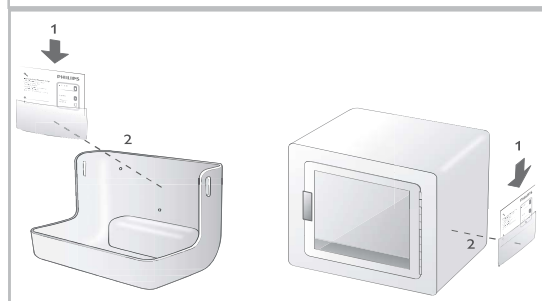

- Store the FRx in accordance with your site's emergency response protocol. Typically, this will be in a high-traffic area that is easy to access, convenient for checking the Ready light periodically, and easy to hear the alarm chirp if the battery power gets low or the defibrillator needs attention. Ideally, the FRx should be stored near a telephone, so the Emergency Response Team or Emergency Medical Services can be alerted as fast as possible in the event of a possible SCA.

* In Japan, the defibrillator comes with a different style of maintenance tag and inspection log/maintenance booklet. Refer to the accompanying instructions for using these items.

In general, treat the FRx as you would any piece of electronic equipment, such as a computer. Be sure to store the FRx according to its specifications. See Appendix E for details. As long as a battery and a pads set are installed, the green Ready light should be blinking to show that the FRx has passed its most recent self-test and is therefore ready to use.

NOTE: Always store the FRx with a set of SMART Pads and a battery installed, so it will be ready to use and can perform daily self-tests. Training pads should be stored separately from the FRx to avoid confusion during a use.

RECOMMENDED ACCESSORIES

It is always a good idea to have a spare battery and a spare pads set. Other things that are useful to keep with the FRx include:

- scissors — for cutting the victim's clothes if needed
- disposable gloves — to protect the user
- a disposable razor — to shave the chest if hair prevents good pads contact
- a pocket mask or face shield — to protect the user
- a towel or absorbent wipes — to dry the victim's skin for good pads contact

Philips has a Fast Response Kit with all these items. See Appendix A for information.

If you may need to defibrillate an infant or a child under 55 pounds (25 kg) or 8 years old, it is recommended that you order the Infant/Child Key accessory, available separately. When the Infant/Child Key is inserted in the FRx, the FRx automatically reduces the defibrillation energy to 50 joules and, if optional CPR Coaching is selected, provides coaching appropriate for infants and children. Directions for using the Infant/Child Key are provided in Chapter 3, "Using the HeartStart FRx."

See Appendix A for a list of accessories and training products for the FRx available from Philips.

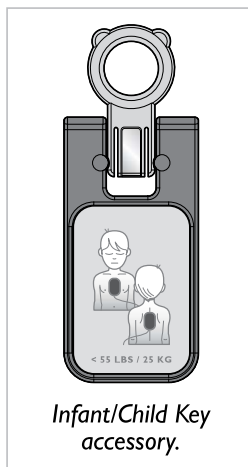

Infant/Child Key accessory.

3 USING THE HEARTSTART FRX

IMPORTANT NOTE: Be sure to read the Reminders section at the end of this chapter as well as the warnings and precautions in Appendix D.

OVERVIEW

If you think someone is in SCA, act quickly and calmly. *If someone else is available*, ask him or her to call for emergency medical assistance while you get the FRx. *If you are alone*, follow these steps:

- Call your emergency services provider.
- Quickly get the FRx and bring it to the victim's side. If there is any delay in getting the defibrillator, check the patient and perform cardiopulmonary resuscitation (CPR) if needed until the FRx is available.
- If the victim is an infant or child, see directions for treating infants and children starting on page 10.
- Check the immediate environment for flammable gases. Do not use the FRx in the presence of flammable gases, such as an oxygen tent. However, it is safe to use the FRx on someone wearing an oxygen mask.

There are three basic steps to using the defibrillator to treat someone who may be in sudden cardiac arrest:

1. Press the green On/Off button.
2. Follow the FRx's voice instructions.
3. Press the flashing orange Shock button if instructed.

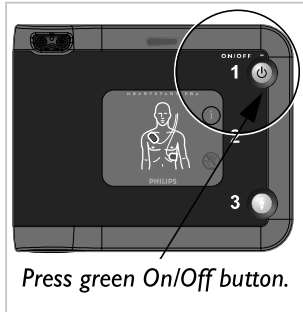

STEP 1: PRESS THE GREEN ON/OFF BUTTON

Press the On/Off button  to turn on the FRx.

The FRx tells you to remove all clothes from the person's chest. If necessary, rip or cut off the clothing to bare the person's chest.

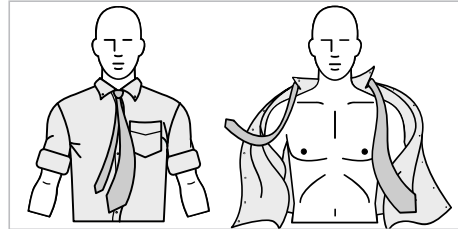

STEP 2: FOLLOW THE FRX'S VOICE INSTRUCTIONS

Remove the SMART Pads II case from the carry case. Clean and dry the patient's skin, and, if necessary, clip or shave excessive chest hair to ensure good pads contact with the bare skin.

Open the pads case as shown below. Peel off one pad.

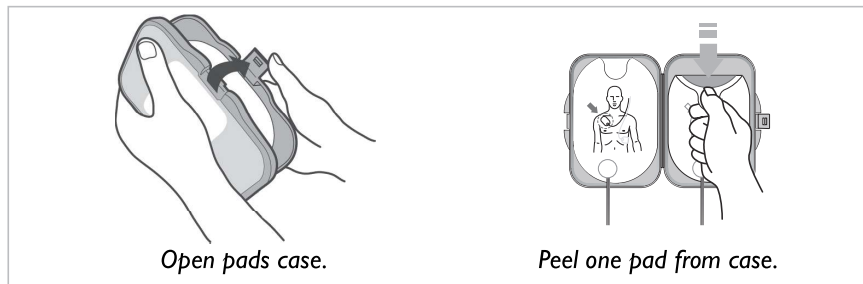

Pads placement is very important. The icons on the pads placement diagram on the FRx front panel will be flashing, to help guide you. Place the pad on the patient's bare skin *exactly as shown* in the following drawing. Press the adhesive portion of the pad down firmly. Then repeat this with the other pad.

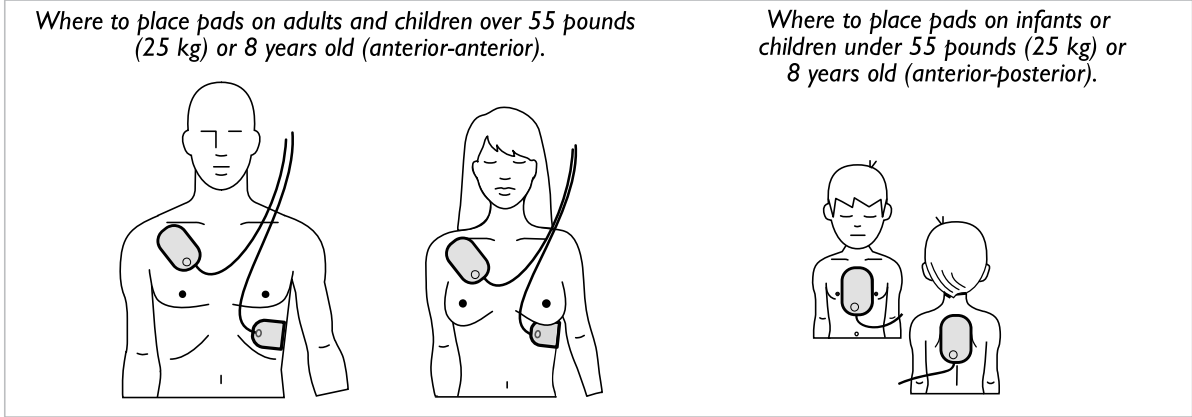

STEP 3: PRESS THE FLASHING ORANGE SHOCK BUTTON IF INSTRUCTED

As soon as the FRx detects that the pads are attached to the patient, the pads icons turn off. The FRx begins analyzing the patient's heart rhythm. It tells you that no one should be touching the patient, and the Caution light begins flashing as a reminder.

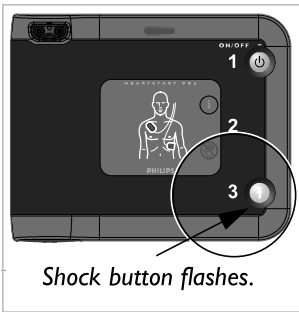
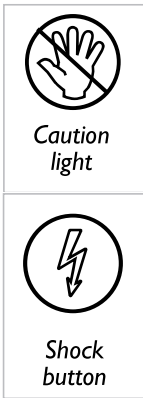

If a shock is needed:

The Caution light stops flashing and stays on, and the orange Shock button starts flashing. The FRx tells you to press the flashing orange button. You must press the Shock button for a shock to be delivered. Before you press the button, make sure no one is touching the patient. When you press the Shock button, the FRx tells you that the shock has been delivered. Then the defibrillator tells you it is safe to touch the patient, instructs you to begin CPR, and invites you to press the flashing blue i-button for CPR Coaching if desired.

If a shock is not needed:

The i-button comes on solid, to show that it is safe to touch the patient. The FRx also tells you to perform CPR if needed. (If CPR is not needed – for example, if the patient is moving or regaining consciousness – follow your local protocol until emergency medical personnel arrive.) Then the FRx invites you to press the flashing blue i-button for CPR Coaching if desired.

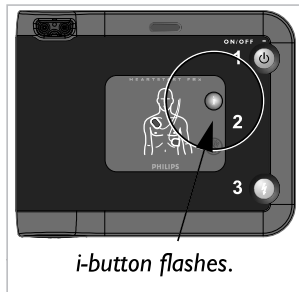

For CPR Coaching:

Press the flashing blue i-button during the first 30 seconds of the patient care pause to activate CPR Coaching.* (If the Infant/Child Key is inserted, the CPR Coaching provided will be for infant/child CPR.) When the pause is over, the defibrillator tells you to stop CPR, so it can analyze the patient's heart rhythm. The motion caused by CPR can interfere with analysis, so be sure to stop all motion when instructed.

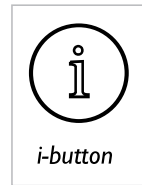

TREATING INFANTS AND CHILDREN

WARNING: Most cardiac arrests in children are not caused by heart problems. When responding to cardiac arrest in an infant or child:

- Provide infant/child CPR while a bystander calls EMS and brings the FRx.
- If no bystander is available, provide 1-2 minutes of CPR before calling EMS and retrieving the FRx.
- If you witnessed the child's collapse, call EMS *immediately* and *then* get the FRx.

Alternatively, follow your local protocol.

* The default configuration for the FRx provides CPR Coaching when you press the i-button in this situation; however, the default setting can be revised by your Medical Director using Philips software available separately. See Appendix F for more information.

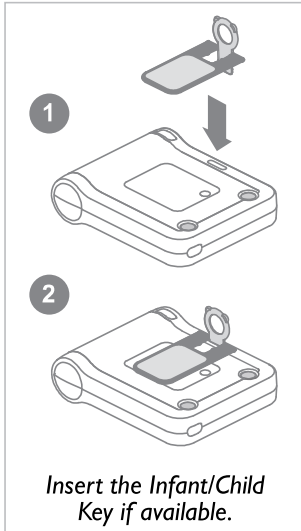

If the victim is under 55 pounds (25 kg) or 8 years old, and you have an Infant/Child Key:

- Insert the Infant/Child Key into the slot at the top center of the front panel of the FRx (see illustration at left). The pink portion of the Key pivots (1) and fits into the slot (2), with the front of the Key lying flat on the surface of the FRx so the infant/child pads placement diagram is visible. (The back of the Infant/Child Key also has a diagram showing how to insert it.)
- Turn on the FRx and follow instructions to remove all clothing from the torso, to bare both the chest and the back.
- Place the pads on the child’s front and back, as illustrated. It does not matter which pad is placed on the chest or the back.

NOTE: It does not matter whether you insert the Infant/Child Key before or immediately after turning on the FRx. However, the Key should be inserted before placing the pads on the patient.

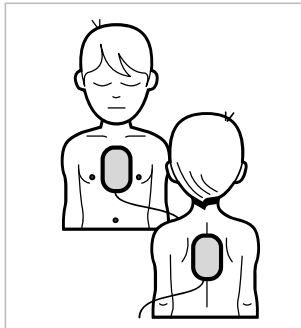

With the Infant/Child Key inserted, the FRx will announce “Infant/ Child Mode,” automatically reduce the defibrillation energy from the adult dose of 150 Joules to 50 Joules,* and provide optional infant/ child CPR Coaching.

If the Infant/Child Key is removed during use, the FRx will announce “Adult Mode.” Any shocks delivered will be at adult energy, and optional CPR Coaching will be for adult CPR.

If the victim is under 55 pounds (25 kg) or 8 years old, but you do NOT have an Infant/Child Key:

- **DO NOT DELAY TREATMENT.**
- Turn on the FRx and follow instructions to remove all clothing from the torso, to bare both the chest and the back.
- Place the one pad in the center of the chest between the nipples, and the other in the center of the back (anterior-posterior).

* This lower energy level may not be effective for treating an adult.

If the victim is over 55 pounds (25 kg) or 8 years old, or if you are not sure of the exact weight or age:

- DO NOT DELAY TREATMENT.
- Turn on the FRx without inserting the Key and follow instructions to remove all clothing from the chest.
- Place the pads as illustrated on each pad (anterior-anterior). Make sure the pads do not overlap or touch each other.

WHEN EMERGENCY MEDICAL SERVICES ARRIVE

When Emergency Medical Services (EMS) personnel arrive to care for the patient, they may decide to apply another defibrillator to allow monitoring of the patient. Depending on their equipment, the EMS team may apply different pads. In that case, the SMART Pads II should be removed. EMS personnel may want a summary of the last-use data* stored in the FRx. To hear the summary data, hold down the i-button until the FRx beeps.

NOTE: After the EMS team removes the SMART Pads II from the patient, remove the Infant/Child Key, if used, and install a new pads set before returning the FRx to service, to be sure it is ready for use.

REMINDERS

- Remove any medicine patches and residual adhesive from the patient's chest before applying the pads.
- Do not place the pads directly over an implanted pacemaker or defibrillator. A noticeable lump with a surgical scar should indicate the position of an implanted device.
- Do not allow the pads to contact other electrodes or metal parts that are in contact with the patient.
- If the pads do not stick well, check that the pads adhesive has not dried out. Each pad has a layer of adhesive gel. If the gel is not sticky to the touch, replace the pads with a new set. (For ease of handling, the pad is designed with a non-gel area around the connector cable.)

* See Chapter 4, "After Using the HeartStart FRx," for details about data storage.

- Keep the patient still and keep any movement around the patient to a minimum during rhythm analysis. Do not touch the patient or the pads while the Caution light is on solid or flashing. If the FRx is unable to analyze due to electrical “noise” (artifact), it will tell you to stop all movement and remind you not to touch the patient. If the artifact continues for more than 30 seconds, the FRx will pause briefly to allow you to deal with the source of the noise, then resume analysis.
- The FRx will only deliver a shock if the flashing orange Shock button is pressed when the instruction is given. If the Shock button is not pressed within 30 seconds after the instruction, the FRx will disarm itself, and (for the first CPR interval) give a reminder to make sure emergency medical services have been called, then begin a CPR interval. This is designed to minimize interruption of CPR and help ensure ongoing patient support.
- While waiting for you to press the Shock button, the FRx will continue to analyze the heart rhythm. If the patient’s rhythm changes before you press the Shock button, and a shock is no longer needed, the defibrillator will disarm and tell you a shock is not advised.
- If for any reason you want to turn off the defibrillator during a use, you can press the On/Off button – holding it down for at least one second – to return the device to standby mode.

4 AFTER USING THE HEARTSTART FRX

AFTER EACH USE

1. Check the outside of the FRx for signs of damage, dirt, or contamination. If you see signs of damage, contact Philips for technical support. If the defibrillator is dirty or contaminated, clean it according to the guidelines in Chapter 5, "Maintaining the HeartStart FRx."
2. The single-use pads must be replaced after being used. Open the SMART Pads II package and take out the pads case (A). *Do not open the pads case until you need to use the pads in an emergency.* Plug the pads cable connector into the connector port on the FRx (B). Store the unopened pads case in the pocket provided in the defibrillator carry case.
3. Plug the cable connector for a new set of SMART Pads II into the FRx.
4. Check supplies and accessories for damage and expiration dates. Replace any used, damaged or expired items. Use a new maintenance tag to record the pads expiration date for the new installed pads. If you replace the spare pads and/or battery be sure to record the dates for them on the maintenance tag as described in Chapter 2. Then sign and date the inspection log/maintenance booklet.

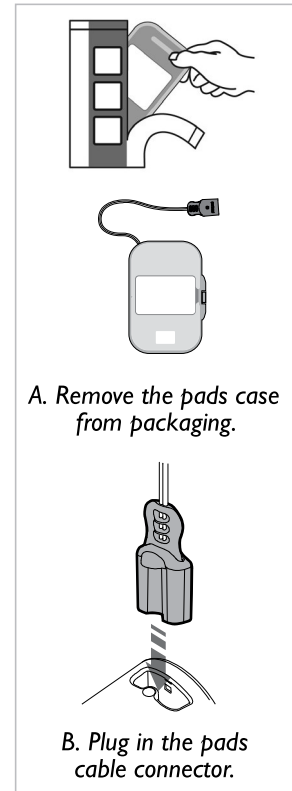

5. Unless your protocol requires that the battery remain installed, remove the battery for five seconds. Then reinstall the battery by placing the bottom end (A) of the battery into the bottom of the compartment on the back of the FRx, then firmly pressing down the top (latch) end of the battery into the compartment, until it clicks into place (B).

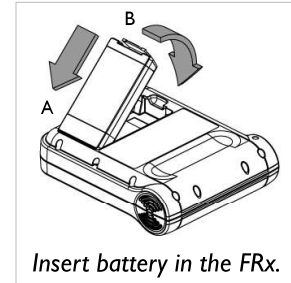

6. The FRx will automatically run a self-test when the battery is inserted. Press the Shock button and On/Off button when instructed. Be sure to let the self-test run all the way to completion. When the self-test is over, the FRx will report the result, and tell you to push the green On/Off button in case of an emergency. (*Do not push the green button unless this is an actual emergency.*) Then the FRx will turn off and go to standby mode. The green Ready light will be blinking to show the FRx is ready for use.*

NOTE: Always store the FRx with a set of SMART Pads and a battery installed, so it will be ready to use and can perform daily self-tests.

7. Return the FRx to its storage location so it will be ready for use when needed. Place the updated inspection log/maintenance booklet on the defibrillator wall mount or cabinet.

FRX DATA STORAGE

The FRx automatically stores data about its last clinical use in its internal memory. The stored data can be conveniently transferred to a personal computer or a handheld computer running the appropriate application in the Philips HeartStart Event Review data management software suite. Event Review software is for use by trained personnel only. Information about HeartStart Event Review is available online at www.philips.com/eventreview.

Follow your local protocol with regard to prompt data transfer for medical review after using the FRx.[†] Details about data transfer and timing are provided in Event Review documentation.

* As long as a battery is installed, turning the FRx “off” puts it into standby mode, which means that it is ready for use.

The information automatically stored by the FRx includes a summary of last-use data and detailed data about its last clinical use. You can get a voice summary of information about the last use of the defibrillator by holding the i-button down until it beeps once. The FRx will tell you how many shocks were delivered and how long it has been since it was turned on. Summary data are available anytime the defibrillator is ready for use (the battery and pads are installed, and the defibrillator is not turned on) or while it is actually in use. Removing the battery erases the summary data for the last use.

Last-use data stored in internal memory include:

- ECG recordings (a maximum of 15 minutes following pads application^{*})
- the FRx's status (entire incident)
- the FRx's rhythm analysis decisions (entire incident)
- the elapsed time associated with stored events (entire incident)

† The FRx automatically stores information about its last clinical use in its internal memory for at least 30 days, so the data can be downloaded to a computer running appropriate Event Review software. (If the battery is removed during this period, the defibrillator retains the files. When the battery is reinstalled, the last-use ECG recording will be kept in defibrillator memory for an additional 30 days.) After this time, the last-use ECG recordings will automatically be erased to prepare for a future use.

* If ECG recordings from a previous use have not been erased, the maximum time for new ECG recordings may be less.

5 MAINTAINING THE HEARTSTART FRX

ROUTINE MAINTENANCE

The FRx is very simple to maintain. The defibrillator performs a self-test every day. In addition, a battery insertion self-test is run whenever a battery is installed in the device. The defibrillator's extensive automatic self-test features eliminate the need for any manual calibration.

WARNING: *Electrical shock hazard.* Do not open the FRx, remove its covers, or attempt repair. There are no user-serviceable components in the FRx. If repair is required, return the FRx to an authorized service center.

REMINDERS:

- Do not leave the defibrillator without a set of pads connected; the defibrillator will start chirping and the i-button will start flashing.
- Do not store the FRx with the Infant/Child Key installed.
- The FRx runs daily self-tests. As long as the green Ready light is blinking, it is NOT necessary to test the defibrillator by initiating a battery insertion self-test. This uses battery power and risks draining the battery prematurely.

PERIODIC CHECKS

Other than the checks recommended after each use of the FRx, maintenance is limited to periodically checking the following:

- Check the green Ready light. If the green Ready light is not blinking, see Troubleshooting Tips, below.
- Replace any used, damaged or expired supplies and accessories.
- Check the outside of the defibrillator. If you see cracks or other signs of damage, contact Philips for technical support.

Record each periodic check in your inspection log/maintenance booklet.

CLEANING THE FRX

The outside of the HeartStart FRx can be cleaned with a soft cloth dampened in soapy water, chlorine bleach (2 tablespoons per quart or liter of water), ammonia-based cleaners, or 70% isopropyl (rubbing) alcohol. It is recommended that the carry case be cleaned with a soft cloth dampened in soapy water.

REMINDERS:

- Do not use strong solvents such as acetone or acetone-based cleaners, abrasive materials, or enzymatic cleaners to clean the FRx and accessories.
- Do not immerse the FRx in fluids. Do not sterilize the FRx or its accessories.

DISPOSING OF THE FRX

The FRx and its accessories should be disposed of in accordance with local regulations.

READY LIGHT TROUBLESHOOTING TIPS

The FRx's green Ready light is your guide to knowing if the defibrillator is ready for use.

- If the Ready light is blinking: The FRx has passed the battery insertion self-test and the last periodic self-test and is therefore ready for use.
- If the Ready light is solid: The FRx is in use or running a self-test.
- If the Ready light is off, the FRx is emitting a series of single chirps, and the i-button is flashing: A self-test error has occurred, there is a problem with the pads, the Infant/Child Key has been left installed, or the battery power is low. Press the i-button for instructions.
- If the Ready light is off, and the FRx is emitting a series of triple chirps, please call Philips for technical support. See "Troubleshooting a chirping HeartStart" on page 21 for more information.
- If the Ready light is off but the FRx is not chirping and the i-button is not flashing: there is no battery inserted, the battery is depleted, or the defibrillator needs repair. Insert/replace battery and run the self-test. As long as the FRx passes the self-test, you can be assured it is ready for use.

TROUBLESHOOTING A CHIRPING HEARTSTART

Your Philips AED tests itself at regular intervals to ensure it is ready for use. If your AED emits a series of single chirps (♪ ... ♪ ... ♪ ...), press the flashing blue i-button for information.

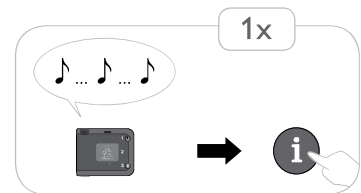

A triple-chirp alert (♪♪♪...♪♪♪...♪♪♪...) could mean that a potentially serious problem was detected during self-test that could prevent your AED from delivering therapy in an emergency. If you ever hear your AED emit a series of triple chirps:

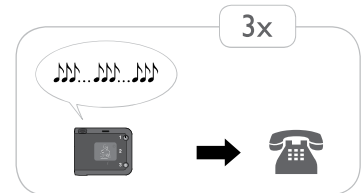

- in stand-by mode — please call Philips immediately for technical support at the regional number listed on the back cover of this manual.
- in an emergency rescue — press the flashing blue i-button and follow the voice prompts. Removing and reinserting the battery can clear some errors and equip the device to deliver therapy in a rescue. The battery removal and reinsertion procedure should only be done in an emergency situation. Once the emergency is over, please call Philips immediately for technical support.

WARNING: Removing and reinserting the battery one or more times when an AED emits a series of triple chirps may reset the device and cause it to report it is ready for use, though it may be unable to deliver therapy during a rescue. Removing and reinserting the battery when your AED is emitting a pattern of triple chirps should only be done during an emergency. *If your device is emitting a series of triple chirps in stand-by mode, or after an emergency, please remove the AED from service and contact Philips immediately.*

More detailed testing and troubleshooting information is available in Appendix G.

APPENDICES

- A Accessories
- B Glossary of terms
- C Glossary of symbols/controls
- D Warnings and precautions
- E Technical information
- F Configuration
- G Testing and troubleshooting
- H Additional technical data required for European conformity

A ACCESSORIES

Accessories* for the HeartStart FRx Defibrillator 861304 available separately from your local Philips representative or online at www.philips.com/heartstart include:

- Batteries (spare is recommended)
 - Battery [REF: M5070A]
 - Aviation applications battery [REF: 989803139301]
- HeartStart SMART Pads II [REF: 989803139261] (spare is recommended)
- Carry Cases
 - FRx carry case [REF: 989803139251]
 - Plastic waterproof hardshell carry case [REF:YC]
- Cabinets and Wall Mounts
 - AED wall mount bracket [REF: 989803170891]
 - Basic surface-mounted cabinet [REF: 989803136531]
 - Premium surface-mounted cabinet [REF: PFE7024D]
 - Premium semi-recessed cabinet [REF: PFE7023D]
- AED Signage
 - AED awareness placard, red [REF: 989803170901]
 - AED awareness placard, green [REF: 989803170911]
 - AED Wall Sign, red [REF: 989803170921]
 - AED Wall Sign, green [REF: 989803170931]
- Infant/Child Key [REF: 989803139311]
- Fast Response Kit (pouch containing a pocket mask, a disposable razor, two pairs of disposable gloves, a pair of paramedic's scissors, and an absorbent wipe) [REF: 68-PCHAT]

* Certain accessories require a prescription in the United States.

- Data Management Software
 - HeartStart Configure [REF: 861487]
 - HeartStart Data Messenger [REF: 861451]
 - HeartStart Event Review [REF: 861489]
 - HeartStart Event Review Pro [REF: 861431]
 - HeartStart Event Review Pro, upgrade [REF: 861436]
- Infrared adapter for use with HeartStart Event Review software [REF: ACT-IR]
- HeartStart FRx Defibrillator Quick Reference Guide [REF: 989803138601]
- Training
 - HeartStart Training Pads II (kit containing one set of Training Pads II in training pads case, adult pads placement guide, Instructions for Use, and illustrated guide) [REF: 989803139271]
 - Replacement Training Pads II (pair of training pads on disposable liner for use in training pads case provided with HeartStart Training Pads II) [REF: 989803139291]
 - Adult pads placement guide [REF: M5090A]
 - Infant/Child pads placement guide [REF: 989803139281]
 - HeartStart FRx Defibrillator Instructor's Training Toolkit, NTSC [REF: 989803139321] or PAL [REF: 989803139331]
 - HeartStart FRx Defibrillator Training DVD [REF: 989803139341]
 - Internal Manikin Adapter [REF: M5088A]
 - External Manikin Adapter, 5 pack [REF: M5089A]

B GLOSSARY OF TERMS

The terms listed in this Glossary are defined in the context of the Philips HeartStart FRx Defibrillator 861304 and its use.

| | |
|----------------|---|
| AED | Automated external defibrillator (a semi-automatic defibrillator). |
| AED mode | The standard treatment mode for the HeartStart FRx Defibrillator. It provides voice instructions guiding the rescuer through applying the adhesive pads, waiting for rhythm analysis, and delivering a shock if needed. |
| analysis | See “SMART analysis.” |
| arrhythmia | An unhealthy, often irregular, beating of the heart. |
| artifact | Electrical “noise” caused by sources such as muscle movements, CPR, patient transport, or static electricity that may interfere with rhythm analysis. |
| battery | The sealed lithium manganese dioxide battery used to power the HeartStart FRx Defibrillator. It is provided in a pack that fits into a compartment on the back of the defibrillator. |
| Caution light | A light on the front of the HeartStart FRx Defibrillator that flashes during rhythm analysis and is on solid when a shock is advised, as a reminder not to touch the patient |
| configuration | The settings for all operating options of the HeartStart FRx Defibrillator, including treatment protocol. The factory default configuration can be modified by authorized personnel using HeartStart Event Review software. |
| CPR | Cardiopulmonary resuscitation. A technique for providing artificial respiration and heart compressions. |
| CPR Coaching | Basic verbal instructions for performing cardiopulmonary resuscitation, including hand placement, rescue breathing, compression depth and timing, provided by the FRx when the flashing blue i-button is pressed during the first 30 seconds of a patient care pause. |
| defibrillation | Termination of cardiac fibrillation by applying electrical energy. |
| ECG | Electrocardiogram, a record of the electrical rhythm of the heart as detected through defibrillation pads. |
| fibrillation | A disturbance of the normal heart rhythm that results in chaotic, disorganized activity that cannot effectively pump blood. Ventricular fibrillation (fibrillation in the lower chambers of the heart) is associated with sudden cardiac arrest. |









| | |
|------------------------------|---|
| HeartStart Event Review | A suite of data management software applications for use by trained personnel to review and analyze FRx Defibrillator patient use and by authorized personnel to alter FRx configuration. Information is available from Philips Medical Systems on the internet at www.philips.com/eventreview . |
| i-button | An “information” button on the front of the HeartStart FRx Defibrillator. If the i-button is pressed during the 30 seconds it flashes during a patient care pause, the FRx provides CPR Coaching;* if the i-button is pressed when it is flashing and the FRx is chirping, the FRx provides troubleshooting guidance. At other times, if the i-button is pressed and held until it beeps once, the FRx provides summary information about its last clinical use and device status. When the i-button is on solid (not flashing), it indicates the user may safely touch the patient. |
| Infant/Child Key | A “key” recommended for use when defibrillating a potential SCA victim under 55 pounds or 8 years old. When inserted into a dedicated slot on the FRx’s front panel, the Infant/Child Key illustrates correct pads placement, with lighted icons, on these young victims. With the Infant/Child Key inserted, the HeartStart FRx automatically reduces the energy of any shock delivered to 50 J and provides CPR Coaching, if selected, appropriate for infants and children. |
| infrared (IR) communications | A method of sending information using a special part of the light spectrum. It is used to transmit information between the HeartStart FRx Defibrillator and a computer running HeartStart Event Review software. |
| NSA | “No Shock Advised,” a decision made by the HeartStart FRx Defibrillator that a shock is not needed, based on analysis of the patient’s heart rhythm. |
| NSA pause | A pause provided by the HeartStart FRx Defibrillator following an No Shock Advised (NSA) decision. The pause can be configured to a “standard” NSA pause or a “SMART” NSA pause. During a standard NSA pause the defibrillator performs no background monitoring of patient rhythm. During a SMART NSA pause, the defibrillator conducts background monitoring and, if it detects an artifact-free shockable rhythm, will exit the pause and begin rhythm analysis. If the HeartStart FRx detects artifact such as that created by CPR, or if the user presses the i-button for CPR Coaching during a SMART NSA pause, the defibrillator will not exit the pause for rhythm analysis in order to allow CPR to be completed uninterrupted. |
| non-shockable rhythm | A heart rhythm that the HeartStart FRx Defibrillator determines is not appropriate for defibrillation. |











* Pressing the i-button for CPR Coaching during a SMART NSA pause turns off background monitoring.









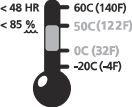



| | |
|-------------------------|---|
| On/Off button | A green button located on the front of the HeartStart FRx Defibrillator. Pressing the On/Off button when the defibrillator is in standby mode turns the defibrillator on; pressing and holding the On/Off button for one second when the defibrillator is on turns the defibrillator off and disarms the defibrillator. In addition, pressing the On/Off button stops the battery insertion self-test that automatically runs when a battery is inserted. |
| pads | See “SMART Pads II.” |
| patient care pause | A defined period to allow CPR. See “NSA pause” and “protocol pause.” |
| periodic self-tests | Daily, weekly, and monthly tests automatically conducted by the HeartStart FRx Defibrillator when it is in its standby mode. The tests monitor many key functions and parameters of the defibrillator, including battery capacity, pads readiness, and the state of its internal circuitry. |
| protocol | A sequence of operations performed by the HeartStart FRx Defibrillator to direct patient care in the AED mode. |
| protocol pause | A period provided by the HeartStart FRx Defibrillator after a shock series, during which the responder can administer CPR. The defibrillator does not conduct background monitoring of the patient’s heart rhythm during this pause. |
| Quick Shock | The ability of the FRx to deliver a defibrillation shock very quickly – typically within 8 seconds – after the end of a patient care pause. |
| Ready light | A green LED showing the readiness for use of the HeartStart FRx Defibrillator. A blinking Ready light means the defibrillator is ready for use; a solid Ready light means the defibrillator is being used. |
| rhythm analysis | See “SMART analysis.” |
| Shock button | An orange button with a lightning bolt symbol on it, located on the front of the HeartStart FRx Defibrillator. The Shock button flashes when a shock is advised. You must press the button for the shock to be delivered. |
| shockable rhythm | A heart rhythm that the HeartStart FRx Defibrillator determines is appropriate for defibrillation, such as ventricular fibrillation and some ventricular tachycardias associated with sudden cardiac arrest. |
| SMART analysis | The proprietary algorithm used by the HeartStart FRx Defibrillator to analyze the patient’s heart rhythm and determine whether a shock is advised. |
| SMART biphasic waveform | The patented, low-energy defibrillation shock waveform used by the HeartStart FRx Defibrillator. It is an impedance-compensated biphasic waveform. It delivers 150 Joules, nominal, into a 50 ohm load; when the Infant/Child Key is inserted, it delivers 50 Joules, nominal, into a 50 ohm load. |





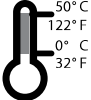

| | |
|-----------------------------|---|
| SMART NSA pause | See “NSA pause.” |
| SMART Pads II | The adhesive pads used with the HeartStart FRx Defibrillator to defibrillate patients of any age or weight. The pads are applied to the patient’s bare skin and used to detect the patient’s heart rhythm and to transfer the defibrillation shock. |
| standby mode | The operating mode of the HeartStart FRx Defibrillator when a battery has been installed, and the unit is turned off and ready for use when needed. Shown by blinking green READY light. |
| standard NSA pause | See “NSA pause.” |
| sudden cardiac arrest (SCA) | Sudden cardiac arrest is the abrupt cessation of the heart’s normal pumping of blood, frequently caused by an electrical malfunction in the heart. SCA results in a stoppage of blood flow, absent or abnormal breathing, and unconsciousness. |
| waveform | See “SMART biphasic waveform.” |

C GLOSSARY OF SYMBOLS/CONTROLS

| symbol | description |
|---|--|
|  | On/Off button. Green. Pressing the On/Off button when the defibrillator is in standby mode turns the defibrillator on; pressing and holding the On/Off button for one second when the defibrillator is on turns the defibrillator off and disarms the defibrillator. In addition, pressing the On/Off button stops the battery insertion self-test that automatically runs when a battery is inserted. |
|  | Information button (i-button). Pressing the i-button while it is flashing during a patient care pause provides CPR Coaching in default configuration; pressing it while it is flashing and the defibrillator is chirping provides troubleshooting guidance. Pressing it until it beeps at other times provides summary information about the defibrillator's last clinical use. Pressing it briefly in standby mode gives device status. |
|  | Caution light. Flashes during rhythm analysis, and is on but not flashing when a shock is advised, as a reminder not to touch the patient. |
|  | Shock button. Orange. If a shock is needed, flashes when the defibrillator is charged. The defibrillator directs the user to press the Shock button to deliver a shock to the patient. |
|  | Refer to operating instructions. |
|  | Lithium manganese dioxide battery. |
| TSO C-142 | TSO C-142 certified battery (989803139301 only) |
|  | One battery in package. |
|  | Do not crush the battery. |
|  | Do not expose the battery to high heat or open flames. Do not incinerate the battery. |

| symbol | description |
|---|---|
|  | Do not mutilate the battery or open the battery case. |
|  | Needs to be protected from moisture. |
|  | Handle with care. |
|  | This side up. |
|  | Defibrillation protection. Defibrillation protected, type BF patient connection. |
| IP55 | Meets IEC 60529 class IPx5 for jetting water from any direction and class IP5x for protection against access to hazardous parts and ingress of solid foreign objects (dust protected). |
|  | Certified by the Canadian Standards Association. |
|  | Meets the requirements of the applicable European Directives, including RoHS Directive 2011/65/EU, The Restriction of the Use of Certain Hazardous Substances in Electrical and Electronic Equipment. |
|  | Meets the requirements of the European Medical Device Directive 93/42/EEC. The four numerical digits indicate the identification number of the Notified Body involved in assessing the product's conformity with the directive. |
|  | Printed on recycled paper. |
|  | Storage requirements (refer to associated thermometer symbol). |
|  | Transportation requirements (refer to associated thermometer symbol). |
|  | Environmental requirements for transportation (black text) and storage (gray text). |

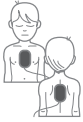
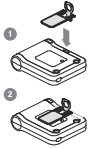
| symbol | description |
|---|--|
|  | Environmental requirements. |
| < XX% | Relative humidity requirements. |
|  INSTALL BEFORE | Install the battery in the defibrillator before the date (MM-YYYY) shown on the associated label. |
|  | Reference order number. |
|  | Serial number. |
|  | Lot number. |
|  | Class 9 miscellaneous dangerous goods. (Symbol required on outer packaging by freight carrier regulations to identify shipments containing lithium batteries.) |
|  | On HeartStart SMART Pads II (989803139261 only). These pads are disposable and are for single patient use only. |
|  | Contents: one set of two defibrillation pads. |
|  | Store the pads at temperatures between 32° and 122° F (0° and 50° C). |
|  | This product is not made with natural rubber latex. |
|  | This product is not sterile. |
|  | Replace pads after 24 hours. |
|  | Expiration (refer to associated date code). |
| MM - YYYY | Expiration date. |

| symbol | description |
|---|---|
| Rx only | Federal law (USA) restricts this device to sale by or on the order of a physician. |
|  | Do not use the FRx in a magnetic resonance environment. |
|  | Not for use with Laerdal defibrillator models 911, 1000, 2000, or 3000. |
|  | Not for use with HeartStart HSI defibrillators, including HeartStart Home and HeartStart OnSite. |
|  | Fits Philips HeartStart designated connector ports, including FR2+ and MRx. |
|  | Pads placement illustration. |
| < 55 LBS / 25 KG | For use on infants and children under 55 pounds (25 kg). |
|  | Insert Infant/Child Key into slot on FRx. |
|  | Wastes must be discarded in an environmentally sound manner in compliance with local regulations. |
| 20XX GUIDELINES | Indicates the AHA/ERC/ILCOR resuscitation Guidelines version for which the device is optimized (expressed as a year). |
| MADE IN USA | Made in USA. |
|  | Example of the Unique Device Identification (UDI) bar code. |

D WARNINGS AND PRECAUTIONS

It is important to understand how to use your HeartStart FRx Defibrillator safely. Please read these warnings and precautions carefully.

A **warning** describes something that could cause serious personal injury or death. A **precaution** describes something that could cause minor personal injury, damage to the FRx, loss of data stored in the FRx, or less chance of successful defibrillation.

NOTE: The HeartStart FRx Defibrillator is designed to be used only with Philips-approved accessories. The FRx may perform improperly if non-approved accessories are used.

WARNINGS

| | |
|------------------|---|
| flammable gases | If the FRx is used to give a shock in the presence of flammable gases such as in an oxygen tent, there is a risk of explosion. Move supplemental oxygen and oxygen delivery devices away from the defibrillation pads. (However, it is safe to use the FRx on someone wearing an oxygen mask.) |
| battery | The HeartStart M5070A and 989803139301 batteries are not rechargeable. Do not try to recharge, open, crush, or burn the battery, or it may explode or catch fire. |
| fluids | Do not let fluids to get into the FRx. Avoid spilling any fluids on the FRx or its accessories. Spilling fluids into the FRx may damage it or cause a fire or shock hazard. Do not sterilize the FRx or its accessories. |
| accessories | Using damaged or expired equipment or accessories may cause the HeartStart FRx Defibrillator to perform improperly, and/or injure the victim or the user. |
| patient handling | Performing CPR or otherwise handling or moving the patient while the FRx is analyzing heart rhythm can cause an incorrect or delayed analysis. If the FRx tells you a shock is advised while you are handling or moving the patient, stop the vehicle or CPR and keep the patient as still as possible for at least 15 seconds. This will give the FRx time to reconfirm the analysis before telling you to press the Shock button. |

- cell phones The FRx can work correctly when it is fairly close to equipment like emergency two-way radios and cell phones. Normally, using a cell phone near the patient should not cause a problem for the FRx. However, it is best to keep such equipment only as close as necessary to the patient and the FRx.
- pads Do not allow the pads to contact other electrodes or metal parts that are in contact with the patient.

PRECAUTIONS

- device handling The FRx was designed to be sturdy and reliable for many different use conditions. However, handling the FRx too roughly can damage it or its accessories and will invalidate the warranty. Check the FRx and accessories regularly for damage, according to directions.
- maintenance Improper maintenance may damage the FRx or cause it to function improperly. Maintain the FRx according to directions.
- skin burns Do not let the pads touch each other or other electrodes, lead wires, dressings, medicine patches, etc. Such contact can cause electrical arcing and skin burns during a shock and may also divert the electrical current away from the patient's heart. During a shock, air pockets between the skin and pads can cause skin burns. To help prevent air pockets, make sure pads stick well to the skin. Do not use dried out pads because they will not provide good contact with the skin.
- patient handling Before delivering a shock, it is important to disconnect the patient from other medical electrical equipment, such as blood-flow meters, that may not incorporate defibrillation protection. In addition, make sure the pads are not in contact with metal objects such as a bed frame or stretcher.

E TECHNICAL INFORMATION

HEARTSTART FRX 86 | 304 DEFIBRILLATOR SPECIFICATIONS

The specifications provided in the following tables are nominal values. Additional information can be found in the *Technical Reference Manuals* for HeartStart Automated External Defibrillators, located online at www.philips.com/productdocs.

PHYSICAL

| category | specifications |
|--------------------|---|
| size | 2.4" H x 7.1" D x 8.8" W (6 cm H x 18 cm D x 22 cm W). |
| weight | Approximately 3.5 lbs (1.6 kg) with battery and pads installed. |
| pads compatibility | HeartStart SMART Pads II 989803139261 (In an emergency or during use, HeartStart DP series 989803158211 and 989803158221 pads may be used. However, the FRx should not be stored with these pads installed, as the daily self-test will not give a "pass" result and the device will chirp.) |

ENVIRONMENTAL

| category | specifications |
|-----------------------------------|---|
| temperature and relative humidity | Operating (battery installed, pads connected): 32° to 122° F (0° to 50° C); 0% to 95% RH (non-condensing). Standby (between uses with battery installed and pads connected): 32° to 122° F (0° to 50° C); 10% to 75% RH (non-condensing). Storage/shipping (with battery and pads case): -4° to 140° F (-20° to 60° C) for up to 1 week; 0% to 85% RH (non-condensing) for up to 2 days, thereafter 65% RH maximum. Transient Operating (for 20 minutes or less, after rapid transition from 68° F [20° C]): -4° to 122° F (-20 to 50° C); Under non-condensing humidity conditions. |
| altitude | 0 to 15,000 feet (0 to 4,572 m). |
| atmospheric pressure | 1013 hPA to 590 hPA. |
| shock/drop abuse tolerance | Withstands 4 foot (1.22 meter) drop on any edge, corner, or face of the device onto masonry surface. |

| category | specifications |
|---------------------------------|---|
| vibration | Operating: meets MILSTD 810G Fig. 5146E-1, random. Standby: meets MILSTD 810G Fig. 5146E-2, swept sine (helicopter). |
| sealing | Meets IEC 60529 class IP55. Protected against jetting water from any direction per IEC 60529 class IPx5, and against access to hazardous parts and ingress of solid foreign objects (dust protected) per IEC 60529 class IP5x. |
| crush | 1,100 lb (500 kg) |
| ESD/EMI (radiated and immunity) | See Appendix F. |
| aircraft: method | Meets RTCA/DO-160G:2002 Section 21 (Category M - Radiated Emissions) and Section 20 (Category M - Conducted Immunity, and Category D - Radiated Immunity). |

CONTROLS AND INDICATORS

| category | specifications |
|-----------------------|---|
| controls | Green On/Off button i-button (flashes blue) Orange Shock button Optional Infant/Child Key accessory |
| indicators | Ready light: green, blinks when the defibrillator is in standby mode (ready for use); solid when the defibrillator is being used. i-button: flashes blue when information is available, on solid during patient care pause. Caution light: flashes when the defibrillator is analyzing, comes on solid when the defibrillator is ready to deliver a shock. Shock button: orange, flashes when the defibrillator is charged and ready to deliver a shock. Pads Placement LEDs: flash when FRx is turned on; off once pads are placed on patient. Also operates with Infant/Child Key inserted to indicate pads placement on infants and children under 55 pounds (25 kg) or 8 years old. |
| audio speaker | Provides voice instructions and warning tones during normal use. |
| beeper | Provides chirps when troubleshooting is needed. |
| status indicator | Status indicator LCD displays device readiness for use. |
| low battery detection | Automatic during daily periodic self-testing. |
| low battery indicator | Alarm chirps and flashing blue i-button. |

DEFIBRILLATION WAVEFORM

| category | nominal specifications |
|----------|------------------------|
|----------|------------------------|

waveform parameters

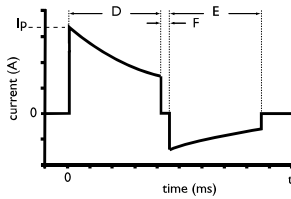

Biphasic truncated exponential. Waveform parameters are automatically adjusted as a function of patient defibrillation impedance. In the diagram at left, D is the duration of phase 1 and E is the duration of phase 2 of the waveform, F is the interphase delay (500 μ s), and Ip is the peak current.

The HeartStart FRx delivers shocks to load impedances from 25 to 180 ohms. The duration of each phase of the waveform is dynamically adjusted based on delivered charge, in order to compensate for patient impedance variations, as shown below:

adult defibrillation

| load resistance (Ω) | phase 1 duration (ms) | phase 2 duration (ms) | peak current (A) | delivered energy (J) |
|------------------------------|-----------------------|-----------------------|------------------|----------------------|
| 25 | 2.8 | 2.8 | 55 | 128 |
| 50 | 4.5 | 4.5 | 32 | 150 |
| 75 | 6.3 | 5.0 | 23 | 155 |
| 100 | 8.0 | 5.3 | 18 | 157 |
| 125 | 9.7 | 6.4 | 14 | 159 |
| 150 | 11.5 | 7.7 | 12 | 160 |
| 175 | 12.0 | 8.0 | 11 | 158 |

pediatric defibrillation
(using Infant/Child Key 989803 | 3931 |)

| load resistance (Ω) | phase 1 duration (ms) | phase 2 duration (ms) | peak current (A) | delivered energy (J) |
|------------------------------|-----------------------|-----------------------|------------------|----------------------|
| 25 | 2.8 | 2.8 | 32 | 43.4 |
| 50 | 4.5 | 4.5 | 19 | 50.2 |
| 75 | 6.3 | 5.0 | 13 | 51.8 |
| 100 | 8.0 | 5.3 | 10 | 52.4 |
| 125 | 9.0 | 6.0 | 8 | 52.3 |
| 150 | 9.0 | 6.0 | 7 | 50.2 |
| 175 | 9.0 | 6.0 | 6 | 48.1 |

| category | nominal specifications | | | | | | | | | | | | |
|------------------------------------|--|-----|-------------|---------|---------|--------|--------|-------------|--------|-------------|--------|-------------|--------|
| energy | <p>Using HeartStart SMART Pads II for adult defibrillation: 150 J nominal ($\pm 15\%$) into a 50 ohm load.</p> <p>Using HeartStart SMART Pads II with Infant/Child Key inserted: 50 J nominal ($\pm 15\%$) into a 50 ohm load. Sample pediatric energy doses:</p> <table border="1"> <thead> <tr> <th>age</th> <th>energy dose</th> </tr> </thead> <tbody> <tr> <td>newborn</td> <td>14 J/kg</td> </tr> <tr> <td>1 year</td> <td>5 J/kg</td> </tr> <tr> <td>2 - 3 years</td> <td>4 J/kg</td> </tr> <tr> <td>4 - 5 years</td> <td>3 J/kg</td> </tr> <tr> <td>6 - 8 years</td> <td>2 J/kg</td> </tr> </tbody> </table> <p>Doses indicated are based on CDC growth charts for the 50th percentile weights.*</p> <p>* National Center for Health Statistics in collaboration with the National Center for Chronic Disease Prevention and Health Promotion. <i>CDC growth charts: weight-for-age percentiles, modified</i> November 21, 2000. Atlanta, GA: Centers for Disease Control and Prevention © 2000.</p> | age | energy dose | newborn | 14 J/kg | 1 year | 5 J/kg | 2 - 3 years | 4 J/kg | 4 - 5 years | 3 J/kg | 6 - 8 years | 2 J/kg |
| age | energy dose | | | | | | | | | | | | |
| newborn | 14 J/kg | | | | | | | | | | | | |
| 1 year | 5 J/kg | | | | | | | | | | | | |
| 2 - 3 years | 4 J/kg | | | | | | | | | | | | |
| 4 - 5 years | 3 J/kg | | | | | | | | | | | | |
| 6 - 8 years | 2 J/kg | | | | | | | | | | | | |
| charge control | Controlled by Patient Analysis System for automated operation. | | | | | | | | | | | | |
| shock-to-shock cycle time | < 20 seconds typical, including analysis. | | | | | | | | | | | | |
| “charge complete” indicator | Shock button flashes, audio tone sounds; device is able to deliver a shock as soon as a shock is advised. | | | | | | | | | | | | |
| patient care pause-to-shock time | Quick Shock. 8 seconds, typical, from end of patient care pause to shock delivery. | | | | | | | | | | | | |
| disarm (AED mode) | Once charged, the HeartStart FRx will disarm if: <ul style="list-style-type: none"> • patient’s heart rhythm changes to non-shockable rhythm, • a shock is not delivered within 30 seconds after the FRx is armed, • the On/Off button is pressed for one second to turn off the FRx, • the Infant/Child Key is inserted or removed, • the battery has been removed or is completely depleted, or • the impedance between pads is out of range. | | | | | | | | | | | | |
| adult shock delivery vector | Via SMART Pads II placed in the anterior-anterior (Lead II) position. | | | | | | | | | | | | |
| infant/child shock delivery vector | Via SMART Pads II typically placed in the anterior-posterior position. | | | | | | | | | | | | |

ECG ANALYSIS SYSTEM

| category | specifications |
|-----------------------|---|
| function | Evaluates impedance of adhesive pads for proper contact with patient skin, and evaluates the ECG rhythm and signal quality to determine if a shock is appropriate. |
| shockable rhythms | Ventricular fibrillation (VF) and some ventricular tachycardias, including ventricular flutter and polymorphic ventricular tachycardia (VT). The HeartStart FRx Defibrillator uses multiple parameters to determine if a rhythm is shockable. <i>NOTE: Some very low-amplitude or low-frequency rhythms may not be interpreted as shockable VF rhythms. Also, for safety reasons, some VT rhythms often associated with circulation may not be interpreted as shockable rhythms.</i> |
| non-shockable rhythms | On detection of any non-shockable rhythm, prompts user to perform CPR if needed. |
| pacemaker detection | Pacemaker artifact is removed from the signal for rhythm analysis. |
| artifact detection | If electrical “noise” (artifact) is detected that interferes with accurate rhythm analysis, analysis will be delayed until the ECG signal is clean. |
| analysis protocol | Depending on results of analysis, either prepares for shock delivery or provides a pause. For details of protocol, see Appendix F, “Configuration.” |

PHILIPS MEDICAL SYSTEMS

APPENDICES

ECG ANALYSIS PERFORMANCE

| rhythm class | ECG test sample ^a size | meets AHA recommendations ^b for adult defibrillation | |
|---|-----------------------------------|---|--------------------------------------|
| | | observed performance | 90% one-sided lower confidence limit |
| shockable rhythm — ventricular fibrillation | 300 | sensitivity >90% | (87%) |
| shockable rhythm — ventricular tachycardia | 100 | sensitivity >75% | (67%) |
| non-shockable rhythm — normal sinus rhythm | 300 | specificity >99% | (97%) |
| non-shockable rhythm — asystole | 100 | specificity >95% | (92%) |

| rhythm class | ECG test sample ^a size | meets AHA recommendations ^b for adult defibrillation | |
|---|-----------------------------------|---|--------------------------------------|
| | | observed performance | 90% one-sided lower confidence limit |
| non-shockable rhythm — all other non-shockable rhythms ^c | 450 | specificity >95% | (88%) |

a. From Philips Medical Systems ECG rhythm databases.

b. American Heart Association (AHA) AED Task Force, Subcommittee on AED Safety & Efficacy. Automatic External Defibrillators for Public Access Use: Recommendations for Specifying and Reporting Arrhythmia Analysis Algorithm Performance, Incorporation of New Waveforms, and Enhancing Safety. *Circulation* 1997;95:1677-1682.

c. Supraventricular tachycardia (SVT) is specifically included in the non-shockable rhythm class, in accordance with AHA recommendations^b and the AAMI standard DF80.

ACCESSORIES SPECIFICATIONS

HEARTSTART SMART PADS II 989803 | 39261

| category | specifications | | |
|--|--|-------------------|--------------------------|
| pads for defibrillation, pacing, monitoring, cardioversion | Disposable, adhesive pads with a nominal active surface area of 80 cm ² each, provided in a disposable plastic case, and an integrated 48 inch (121.9 cm), typical, cable. Pads in case are designed to fit into carry cases. | | |
| SMART Pads II compatibility | defibrillator model | adult patient use | infant/child patient use |
| | FRx* | yes | yes |
| | FR3 | yes | yes |
| | FR2/FR2+ | yes | no; use M3870A |
| | FR/ForeRunner | yes | no |
| | MRx/XL/XLT/4000 | yes | manual mode only |
| | HSI/OnSite/Home | no; use M5071A | no; use M5072A |
| | competitive adapters | yes | manual mode only |
| | * Pre-connectable to FRx defibrillator only. | | |
| pads shelf life | Pads package is labeled with a use-by date of at least two years from date of manufacture. | | |

M5070A BATTERY AND 989803|3930| TSO C-142* BATTERY

| category | specifications |
|--|---|
| battery type | 9VDC, 4.2 Ah, lithium manganese dioxide. Disposable, long-life primary cell. |
| capacity | When new, a minimum of 200 shocks or 4 hours of operating time at 77° F (25° C). |
| shelf life (prior to insertion) | A minimum of 5 years from date of manufacture when stored and maintained according to directions provided in this document. |
| standby life (after insertion) | Typically, 4 years when stored and maintained according to directions provided in this document. |
| training life | Supports 10 hours of use in training mode. |
| battery limitations | Never charge, short circuit, puncture, deform, incinerate, heat above 140° F (60° C), or expose contents to water. Remove the battery when discharged. |
| maintenance and calibration requirements for continued airworthiness (989803 3930 only) | There are no periodic maintenance or calibration requirements that are necessary for continued airworthiness of the 989803 3930 battery. For battery maintenance with respect to performance within the AED, please see Chapter 5. There are no user-serviceable parts in the battery. |
| environmental qualification per RTCA/DO-227, Section 2.3 | Meets following acceptance criteria: No leaking, venting, distortion, fire, or rupture. Change in open circuit voltage <2%. |

INFANT/CHILD KEY 989803|3931|

| category | specifications |
|----------|---|
| size | 6.3" x 2.4" x 0.2" (16 cm x 6 cm x 0.5 cm). |
| weight | 1.0 oz (29 g). |
| material | Polycarbonate. |

* The conditions and tests for TSO approval of this article are minimum performance standards. Those installing this article, on or in a specific type or class of aircraft, must determine that the aircraft installation conditions are within the TSO standards. TSO articles must have separate approval for installation in an aircraft. The article may be installed only according to 14 CFR part 43 or the applicable airworthiness requirements. Lithium cell and battery safety concerns include the possibility of fire and venting of toxic gases.

ENVIRONMENTAL CONSIDERATIONS

By complying with your national or local regulations regarding disposal of electric, electronic, and battery waste, you can make a positive contribution to our shared environment.

| product | information |
|---------------|--|
| defibrillator | The defibrillator contains electronic components. Do not dispose of it as unsorted municipal waste. Collect such electronic waste separately and dispose of it at an appropriate recycling facility according to your country's or local regulations. |
| battery | The battery cells contain chemicals. The chemistry used in each battery is identified by a symbol on the label; symbols are defined in the defibrillator User's Guide/Instructions for Use/Owner's Manual. Recycle the battery at an appropriate recycling facility. |
| pads | The used pads may be contaminated with body tissue, fluid, or blood. Dispose of them as infectious waste. Recycle the case at an appropriate recycling facility. |

The Registration, Evaluation, Authorization, and Restriction of Chemicals (REACH), a European Union regulation, requires Philips Healthcare to provide chemical content information for Substances of Very High Concern (SVHC) if they are present above 0.1% of the article weight. The SVHC list is updated on a regular basis. Therefore, refer to the following Philips REACH website for the most up-to-date list of products containing SVHC above the threshold: <http://www.philips.com/about/sustainability/REACH.page>

F CONFIGURATION

OVERVIEW

The Philips HeartStart FRx Defibrillator comes with a factory default configuration designed to meet the needs of most users. This configuration can only be changed by using HeartStart Configure version 1.0 or higher, Event Review version 3.2 or higher, or Event Review Pro 3.1 or higher. This software is for use by trained personnel. Information about HeartStart data management products is available online www.philips.com/eventreview. See Appendix A for ordering information.

DEVICE OPTIONS

The following table includes the features of FRx operation that are not related to patient treatment.

| parameter | settings | default | default description |
|---|------------------------|---------|--|
| speaker volume | 1, 2, 3, 4, 5, 6, 7, 8 | 8 | The volume of the FRx's speaker is set to 8, highest. |
| auto send periodic self-test (PST) data | On, Off | On | Enables the periodic self-test data to be broadcast through the device's infrared data port. |
| ECG out data | On, Off | On | Enables the ECG data to be broadcast through the device's infrared data port. |

* A shock series begins when a shock is delivered after the FRx is turned on. A new shock series begins after a protocol pause. If shock series is configured for 2 or more, a new shock series also begins if the time since the previous shock exceeds the shock series interval setting.

PATIENT TREATMENT PROTOCOL OPTIONS

| parameter | settings | default | default description |
|----------------------------------|---|---|--|
| "call EMS" voice reminder timing | <ul style="list-style-type: none"> • At power on (when the user turns on the FRx) • At power on and at the start of the first patient care pause • At the start of the first patient care pause • No reminder | At the start of the first patient care pause. | Provides a voice reminder to make sure emergency medical services have been called, at the start of the first patient care pause. |
| shock series | 1, 2, 3, 4 | 1 | <p>The automatic protocol pause for CPR is activated each time a shock is delivered.*</p> <p>During the protocol pause, the FRx does not perform rhythm analysis.</p> <p>The length of the protocol pause after a shock series is completed is determined by the protocol pause timer setting.</p> |
| shock series interval (minutes) | 1.0, 2.0, ∞ (infinity) | 1.0 | <p>A delivered shock must occur within 1 minute of the previous shock to be counted as part of the current shock series.</p> <p><i>NOTE: This parameter is only applicable when the shock series is not configured to the default 1 shock.</i></p> |

| parameter | settings | default | default description |
|--------------------------------|--|-----------------|--|
| protocol pause timer (minutes) | 0.5, 1.0, 1.5, 2.0, 2.5, 3.0 | 2.0 | <p>A 2-minute protocol pause for CPR automatically starts after voice instruction is given when a shock series is completed. After the protocol pause, the defibrillator returns to rhythm analysis.</p> <p>If the user presses the i-button for optional CPR coaching, the FRx provides coaching for 5 cycles of CPR, starting and ending with compressions, when the CPR Coaching parameters are also set to their default values. The number of CPR cycles varies for other protocol pause timer and CPR Coaching parameter settings.</p> |
| NSA pause type | <ul style="list-style-type: none"> Standard NSA pause: FRx does not perform rhythm analysis during the NSA pause. SMART NSA pause: FRx conducts background monitoring during the SMART NSA pause. If a potentially shockable rhythm is detected, FRx terminates the SMART NSA pause and resumes rhythm analysis. | SMART NSA pause | <p>During a SMART NSA pause, the defibrillator conducts background monitoring. If a potentially shockable rhythm is detected in a motionless patient, the defibrillator terminates the SMART NSA pause and resumes rhythm analysis.</p> <p><i>NOTE: If the FRx detects CPR in progress or if the responder has pressed the i-button for CPR Coaching, the SMART NSA pause will be converted to a standard NSA pause. During the standard NSA pause, the defibrillator does not perform rhythm analysis.</i></p> |

* If the shock series is configured to 2 or more, and a shock has been delivered as part of a series, the length of the first NSA pause interval within that shock series is determined by the protocol pause timer setting. Otherwise, the length of an NSA pause is determined by the NSA pause timer setting.

| parameter | settings | default | default description |
|--|--|---|---|
| NSA pause timer (minutes) | 0.5, 1.0, 1.5, 2.0, 2.5, 3.0 | 2.0 | <p>A 2-minute NSA pause for CPR automatically starts after voice instruction is given when no shock is advised (NSA).*</p> <p>If the user presses the i-button for optional CPR coaching, the FRx provides coaching for 5 cycles of CPR, starting and ending with compressions, when the CPR Coaching parameters are also set to their default values. The number of CPR cycles varies for other NSA pause timer and CPR Coaching parameter settings.</p> |
| CPR prompt | <ul style="list-style-type: none"> • CPR1: Instructs the user to begin CPR. • CPR2: Instructs the user that it is safe to touch the patient and to begin CPR. • CPR3: Instructs the user to begin CPR and to press the i-button for CPR Coaching. • CPR4: Instructs the user that it is safe to touch the patient, to begin CPR, and to press the i-button for CPR Coaching. | <p>CPR4: Instructs the user that it is safe to touch the patient, to begin CPR, and to press the i-button for CPR Coaching.</p> | <p>The CPR reminder voice instructions provided at the beginning of a pause interval assures the user that it is safe to touch the patient, instructs the user to begin CPR, and invites the user to press the i-button for guidance in the basic steps of CPR.</p> <p><i>NOTE: CPR Coaching is available only with the CPR3 and CPR4 settings.</i></p> |
| CPR Coaching adult ventilation instruction | yes, no | yes | <p>Optional CPR Coaching includes rescue breaths at the rate determined by the CPR Coaching compression: ventilation ratio for adults when an adult pads set is installed.</p> <p><i>NOTE: If this parameter is configured to NO, CPR Coaching will always be compressions-only when an adult pads set is installed.</i></p> |

| parameter | Intentionally blank settings | default | default description |
|---|--|----------------------------------|--|
| CPR Coaching infant/child ventilation instruction | yes, no | yes | Optional CPR Coaching includes rescue breaths at the rate determined by the CPR Coaching compression:ventilation ratio for infants and children when an infant/child pads set is installed. <i>NOTE: If this parameter is configured to NO, CPR Coaching will always be compressions-only when an infant/child pads set is installed.</i> |
| CPR Coaching compression:ventilation ratio | <ul style="list-style-type: none"> • 30:2 adult and 30:2 infant/child • 30:2 adult and 15:2 infant/child • 15:2 adult and 15:2 infant/child | 30:2 adult and 30:2 infant/child | When the user presses the i-button for optional CPR Coaching during a protocol pause or NSA pause, the FRx will provide coaching in basic CPR for cycles of 30 compressions and 2 ventilations for adults, children, and infants. Pauses begin and end with compressions. |

G TESTING AND TROUBLESHOOTING

TESTING

The HeartStart FRx Defibrillator automatically tests its battery, connected SMART Pads II, and internal circuitry every day. It alerts you if it finds a problem. See the *Technical Reference Manuals* for HeartStart Automated External Defibrillators, located online at www.philips.com/productdocs, for a detailed discussion of the self-tests.

You can also test the defibrillator at any time by removing the battery for five seconds then reinstalling it. This test takes about one minute. Because the battery insertion self-test is very detailed and uses battery power, running it more often than necessary will drain the battery prematurely. It is recommended that you run the battery insertion self-test only:

- when the defibrillator is first put into service.
- after each time the defibrillator is used to treat a patient.
- when the battery is replaced.
- when the defibrillator may have been damaged.

NOTE: If the FRx turns off when you install the battery instead of running the battery insertion self-test, check to be sure that the pads case is not open. If the pads case is open, the FRx assumes that it may be in use and so will not run the self-test.

If you need to use the defibrillator to treat a victim of SCA while you are running a battery self-test, press the On/Off button to stop the test and turn on the HeartStart FRx for use.

TROUBLESHOOTING

The FRx's green Ready light is the signal that tells you if the defibrillator is ready for use. The defibrillator chirps and the i-button flashes to alert you to a problem.

RECOMMENDED ACTION WHEN YOU NEED TO USE THE DEVICE

If the FRx is chirping and the i-button is flashing, it is possible that the defibrillator still has enough battery power to be used to treat a victim of SCA. Press the On/Off button.

If the FRx does not turn on when you press the On/Off button, remove the battery and replace it with a new battery if available and press the On/Off button to turn on the defibrillator. If no spare battery is available, remove the installed battery for five seconds, then reinsert it and run a battery insertion self-test.

If the problem continues, do not use the defibrillator. Attend to the patient, providing CPR if needed, until emergency medical personnel arrive.

TROUBLESHOOTING WHILE THE FRX IS BEING USED
(GREEN READY LIGHT IS SOLID)

Always follow any instructions the device gives.

| defibrillator says: | possible cause | recommended action |
|--|---|--|
| ... to replace the battery immediately | The battery is nearly depleted. The FRx will turn off unless a new battery is installed. | Install a new battery immediately. |
| ... to plug in pads connector ... to replace pads | <ul style="list-style-type: none"> • The pads connector has been unplugged. • The pads have been damaged. • The pads have been peeled from the case, but have not been successfully attached to the patient. There may be a problem with the pads. | <ul style="list-style-type: none"> • Plug in the pads connector. • Replace the damaged pads. • Replace the pads on patient with new pads to continue with the rescue. |

| defibrillator says: | possible cause | recommended action |
|---|---|---|
| <p>... to press the pads firmly to the skin</p> <p>... to make sure the pads have been removed from the case</p> <p>... the pads should not be touching the patient's clothing</p> <p>... to make sure the pads connector is fully inserted</p> | <ul style="list-style-type: none"> • The pads are not properly applied to the patient. • The pads are not making good contact with the patient's bare chest because of moisture or excessive hair. • The pads are touching each other. • The pads may not have been removed from the case or may be on the patient's clothing. • Pads connector is not fully inserted. | <ul style="list-style-type: none"> • Make sure that the pads are sticking completely to the patient's skin. • If the pads are not sticking, dry the patient's chest and shave or clip any excessive chest hair. • Reposition the pads. • Make sure pads are not in the case or on patient's clothing. • Make sure the pads connector is fully inserted. <p>If the voice instruction continues after you do these things, replace the pads set.</p> |
| <p>... to stop all motion</p> | <ul style="list-style-type: none"> • The patient is being moved or jostled. • The environment is dry and movement around the patient is causing static electricity to interfere with ECG analysis. • Radio or electrical sources are interfering with ECG analysis. | <ul style="list-style-type: none"> • Stop CPR; do not touch the patient. Minimize patient motion. If the patient is being transported, stop the vehicle. • Responders and bystanders should minimize motion, particularly in dry environments that can generate static electricity. • Check for possible causes of radio and electrical interference and turn them off or remove them from the area. |
| <p>... the shock was not delivered</p> | <ul style="list-style-type: none"> • The pads may not be making good contact with the patient's skin. • The pads may be touching each other. • The pads may be damaged. | <ul style="list-style-type: none"> • Press the pads firmly to the patient's chest. • Make sure the adhesive pads are correctly positioned on the patient. • Replace the pads if necessary. |
| <p>... the shock button was not pressed</p> | <p>Shock has been advised but the shock button has not been pressed within 30 seconds.</p> | <p>When next prompted, press the Shock button to deliver shock.</p> |

TROUBLESHOOTING WHILE THE FRX IS NOT BEING USED
(GREEN READY LIGHT IS NOT ON)

Press the i-button to check defibrillator status, and follow any instructions the device gives.

NOTE: In the event of a triple-chirp alert, even if the failure is cleared by a battery insertion test, please contact Philips for service. In the event of repeated instances of a self-test failure resulting in single-chirp alerts, even if such failures are cleared by a battery insertion test, please contact Philips for service.

| behavior | possible cause | recommended action |
|----------------------------|--|--|
| chirps or i-button flashes | <ul style="list-style-type: none"> • The battery power is low or the pads need to be replaced. • The pads may be damaged or the adhesive dried out. • The pads case may be open. • The defibrillator may have been turned off without a pads set installed. • The Training Pads II set has been left in the defibrillator. • The Infant/Child Key may have been left installed. • The defibrillator has been stored outside the recommended temperature range. • The defibrillator has detected an error during a self-test or cannot perform a self-test, or the Shock button is damaged. | <ul style="list-style-type: none"> • Press the flashing blue i-button. Replace the battery or pads if instructed. • Replace the pads with a new set and do not open the case until pads are needed in an emergency. • Make sure the pads case is closed. • Make sure the pads are properly installed. (See Chapter 2 for directions.) • Remove the Training Pads II set and replace it with a set of SMART Pads II. • Remove the Infant/Child Key. • Remove the battery for five seconds then reinstall it to start the battery insertion self-test. If it fails, insert a new battery to repeat the test. If it fails again, do not use the defibrillator. If it passes, store the defibrillator within the recommended temperature range. • Contact Philips for service. |

| behavior | Intentionally blank. possible cause | recommended action |
|--|---|---|
| no chirping and/or i-button does not flash, or no response to pressing i-button | <ul style="list-style-type: none"> • The battery is missing or completely depleted. • The defibrillator may have been physically damaged. | <ul style="list-style-type: none"> • Remove the battery for five seconds then reinstall it to start the battery insertion self-test. If it fails, insert a new battery and repeat the test. If it fails again, do not use the defibrillator. • Contact Philips for service. |

H ADDITIONAL TECHNICAL DATA REQUIRED FOR EUROPEAN CONFORMITY

ELECTROMAGNETIC CONFORMITY

Guidance and manufacturer's declaration: The HeartStart FRx is intended for use in the electromagnetic environment specified in the tables below. The customer or user of the HeartStart FRx should assure that it is used in such an environment.

ELECTROMAGNETIC EMISSIONS

| emissions test | compliance | electromagnetic environment – guidance |
|----------------|--------------------|---|
| RF CISPR 11 | Group I Class B | <p>The FRx uses RF energy only for its internal function. Therefore, its RF emissions are very low and are not likely to cause any interference in nearby electronic equipment.</p> <p>The FRx is suitable for use in all establishments, including industrial establishments, domestic establishments, and those directly connected to the public low-voltage power supply network that supplies buildings used for domestic purposes.</p> |

ELECTROMAGNETIC IMMUNITY

The FRx is intended for use in the electromagnetic environment specified below. The customer or the user of the FRx should assure that it is used in such an environment.

| immunity test | IEC 60601 test level | compliance level | electromagnetic environment – guidance |
|--|--|-------------------------------|---|
| electrostatic discharge (ESD) IEC 61000-4-2 | ± 6 kV contact ± 8 kV air | ± 8 kV contact ± 15 kV air | There are no special requirements with respect to electrostatic discharge. ^a |
| power frequency (50/60 Hz) magnetic field IEC 61000-4-8 | 3 A/m | 30 A/m | Power frequency magnetic fields should be at levels characteristic of a typical location in a typical commercial/hospital environment. There are no special requirements for non-commercial/non-hospital environments. |
| conducted RF IEC 61000-4-6 | 3 Vrms 150 kHz to 80 MHz outside ISM bands ^b | 3 Vrms | Recommended separation distance: $d = 1.2 \sqrt{P}^c$ |
| | 10 Vrms 150 kHz to 80 MHz in ISM bands ^b | 10 Vrms | $d = 1.2 \sqrt{P}^c$ |

- Generally, AEDs are sometimes susceptible to interference generated by patient and/or responder motion in environments in which a high static electric field is present (e.g., low humidity, synthetic carpets, etc.). As a safety measure, Philips AEDs incorporate a patented method to sense possible corruption of the ECG signal by such interference and to respond by directing the user to stop all motion. In these cases, it is important to minimize movement in the vicinity of the patient during rhythm analysis in order to ensure that the signal being analyzed accurately reflects the patient's underlying heart rhythm.
- The ISM (industrial, scientific and medical) bands between 150 kHz and 80 MHz are 6.765 MHz to 6.795 MHz; 13.553 MHz to 13.567 MHz; 26.957 MHz to 27.283 MHz; and 40.66 MHz to 40.70 MHz.
- The compliance levels in the ISM frequency bands between 150 kHz and 80 MHz and in the frequency range 80 MHz to 2.5 GHz are intended to decrease the likelihood that mobile/portable communications equipment could cause interference if it is inadvertently brought into patient areas. For this reason, an additional factor of 10/3 has been incorporated into the formulae used in calculating the recommended separation distance for transmitters in these frequency ranges.

| immunity test | IEC 60601 test level | compliance level | electromagnetic environment – guidance |
|------------------------------|-------------------------------|------------------|---|
| radiated RF IEC 61000-4-3 | 10V/m 80 MHz to 2.5 GHz | 20V/m | $d = 0.60 \sqrt{P}$ 80 MHz to 800 MHz $d = 1.2 \sqrt{P}$ 80 MHz to 2.5 GHz where P is the maximum output power rating of the transmitter in watts (W) according to the transmitter manufacturer and d is the recommended separation distance in meters (m). ^a Field strengths from fixed RF transmitters, as determined by an electromagnetic site survey, ^b should be less than the compliance level in each frequency range. ^c Interference may occur in the vicinity of equipment marked with the following symbol:  |

NOTE 1. At 80 MHz and 800 MHz, the higher frequency range applies.

NOTE 2. These guidelines may not apply in all situations. Electromagnetic propagation is affected by absorption and reflection from structures, objects and people.

- a. The compliance levels in the ISM frequency bands between 150 kHz and 80 MHz and in the frequency range 80 MHz to 2.5 GHz are intended to decrease the likelihood that mobile/portable communications equipment could cause interference if it is inadvertently brought into patient areas. For this reason, an additional factor of 10/3 has been incorporated into the formulae used in calculating the recommended separation distance for transmitters in these frequency ranges.
- b. Field strengths from fixed transmitters, such as base stations for radio (cellular/cordless) telephones and land mobile radios, amateur radio, AM and FM radio broadcast and TV broadcast cannot be predicted theoretically with accuracy. To assess the electromagnetic environment due to fixed RF transmitters, an electromagnetic site survey should be considered. If the measured field strength in the location in which the HeartStart is used exceeds the applicable RF compliance level above, the HeartStart should be observed to verify normal operation. If abnormal performance is observed, additional measures may be necessary, such a re-orienting or relocating the HeartStart.
- c. Over the frequency range 150 kHz to 80 MHz, field strengths should be less than 3 V/m.

RECOMMENDED SEPARATION DISTANCES BETWEEN PORTABLE AND MOBILE RF COMMUNICATIONS EQUIPMENT AND THE HEARTSTART FRX DEFIBRILLATOR

The HeartStart FRx Defibrillator is intended for use in an electromagnetic environment in which radiated RF disturbances are controlled. The customer or the user of the FRx can help prevent electromagnetic interference by maintaining a minimum distance between portable and mobile RF communications equipment (transmitters) and the FRx as recommended below, according to the maximum output power of the communications equipment.

| rated maximum output power of transmitter (W) | separation distance according to frequency of transmitter (m) | | | |
|---|---|---|---|--|
| | 150 kHz to 80 MHz outside ISM bands $d = 1.2\sqrt{P}$ | 150 kHz to 80 MHz in ISM bands $d = 1.2\sqrt{P}$ | 80 MHz to 800 MHz $d = 0.60\sqrt{P}$ | 800 MHz to 2.5 GHz $d = 1.15\sqrt{P}$ |
| 0.01 | 0.12 | 0.12 | 0.06 | 0.115 |
| 0.1 | 0.38 | 0.38 | 0.19 | 0.36 |
| 1 | 1.2 | 1.2 | 0.60 | 1.15 |
| 10 | 3.8 | 3.8 | 1.9 | 3.64 |
| 100 | 12 | 12 | 6.0 | 11.5 |

For transmitters rated at a maximum output power not listed above, the recommended separation distance d in meters (m) can be determined using the equation applicable to the frequency of the transmitter, where P is the maximum output power rating of the transmitter in watts (W) according to the transmitter manufacturer.

NOTE 1. At 80 MHz and 800 MHz, the separation distance for the higher frequency range applies.

NOTE 2. The ISM (industrial, scientific and medical) bands between 150 kHz and 80 MHz are 6.765 MHz to 6.795 MHz; 13.553 MHz to 13.567 MHz; 26.957 MHz to 27.283 MHz; and 40.66 MHz to 40.70 MHz.

NOTE 3. An additional factor of 10/3 is used in calculating the recommended separation distance for transmitters in the ISM frequency bands between 150 kHz and 80 MHz and in the frequency range 80 MHz to 2.5 GHz to decrease the likelihood that mobile/portable communications equipment could cause interference if it is inadvertently brought into patient areas.

NOTE 4. These guidelines may not apply in all situations. Electromagnetic propagation is affected by absorption and reflection from structures, objects and people.

SHOCK CYCLE TIMING

The FRx's Quick Shock feature allows it to deliver a shock within 8 seconds, typical, following a CPR pause. From shock to shock, the FRx takes <20 seconds, typical, including analysis. After 15 shocks, the FRx takes <30 seconds from analyzing to ready-to-shock. After 200 shocks, the FRx takes <40 seconds from initial power-on to ready-to-shock.

PHILIPS

Philips Healthcare is part of
Royal Philips

Philips Healthcare

United States

Philips Medical Systems
22100 Bothell Everett Highway
Bothell, WA 98021-8431, USA
(800) 263-3342

Canada

Philips Healthcare, a Division of Philips Electronics Ltd.
281 Hillmount Road
Markham, Ontario
L6C 2S3, Canada
(800) 291-6743

Europe, Middle East, and Africa

Philips Medizin Systeme Boeblingen GmbH
Cardiac and Monitoring Systems
Hewlett-Packard Strasse 2
71034 Boeblingen, Germany
+49 7031 463 2254

Latin America

Philips Medical Systems Ltda.
Av. Dr. Marcos Penteado Ulhôa Rodrigues, 401
Parte 16 – 06460-040 – Barueri/SP, Brazil
0800 7017789

Asia Pacific

Philips Electronics Hong Kong Ltd.
6/F, Core Building I
1 Science Park East Avenue
Hong Kong Science Park
Shatin, New Territories, Hong Kong
(852) 2821 5888

REF 989803138731



AED  **Professionals™**

Distributed by AED Professionals - A General Medical Devices, Inc. Company
348 W. Cofax St. Palatine, IL 60067 • 888-541-2337 • www.AEDProfessionals.com