

**Top View**

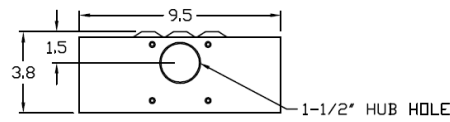

**Front View External**

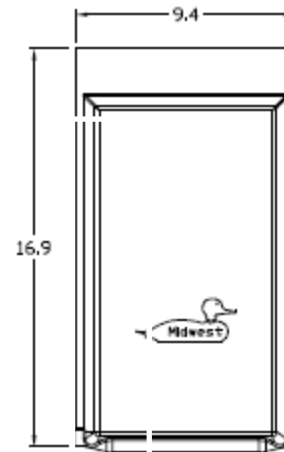

**Right Side View**

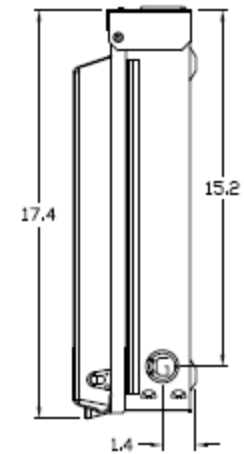

**Left Side View**

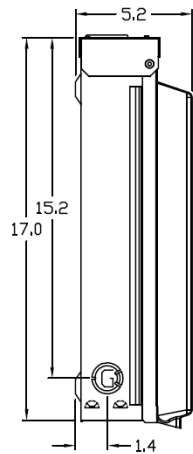

**Front View Interior**

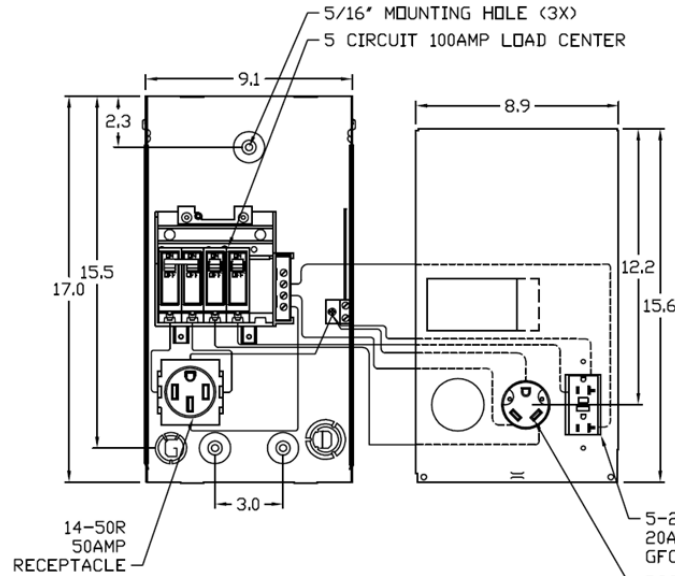

**Front View Inside Cover**

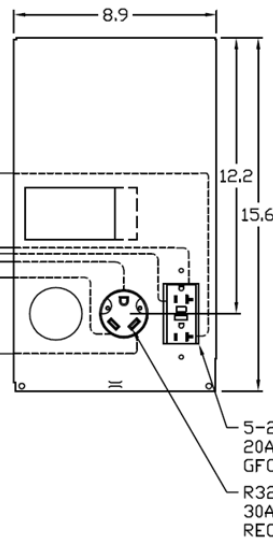

**Bottom View**

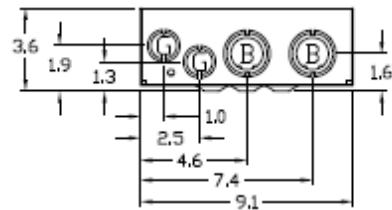

**Wire Range Size**

Connector	Copper		Aluminum	
	Solid	Stranded	Solid	Stranded
Line	14-8	14-1/0	12-8	12-1/0
Load	14-10	14-10	----	----
Neutral Large Hole	12-8	12-1/0	10-8	10-1/0
Neutral Small Hole	14-8	14-4	12-8	12-4
Equip. Ground Post	12-8	12-2	12-8	12-2

**Receptacles**

BR54U
R32U
5-20R2GFCI

**Circuit Protection**

THQL2150
THQL1130
THQL1120, SPACE
THQL1120

**Configuration**

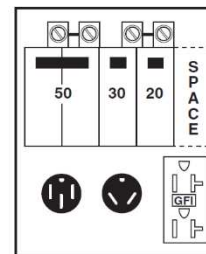

MIDWEST METALLIC RV PEDESTAL SURFACE MNT  
100A UNMETR 120/240V 1PH3W LOOP FEED UL LISTED

CAT NO	DWG DATE	REV #
U075CTL010	07/11/2016	01