

**MILBANK**<sup>®</sup>  
ENERGY AT WORK



# MEG Approval

Meter Equipment Group



# Milbank Overview

*Energy At Work since 1927*

Milbank designs and manufactures electrical solutions that move and manage power for the residential, commercial, industrial, utility and transportation sectors. With more than 90 years of expertise in electrical engineering design and manufacturing, Milbank's portfolio includes metering equipment, enclosures and enclosed controls. Founded in 1927, Milbank is a family-owned, American manufacturer headquartered in Kansas City, Mo. For more information, please visit [milbankworks.com](http://milbankworks.com).

## METERING



As a market leader in electrical metering equipment, Milbank has set the standard for quality since 1927. Hundreds of configurations are available, including many sizes, knockout configurations, terminal configurations, bypass options, hubs, locks and connectors. Milbank has the socket you need with thousands of active products to meet your utility's requirements.

## ENCLOSURES



Milbank's line of enclosures include commercial junction boxes, panel mount enclosures, transformer cabinets, wireway, and troughs. Built with high-quality craftsmanship and materials which meet or exceed industry standards, Milbank enclosures are made to protect controls and equipment from dust, dirt and other harmful elements found in a wide variety of environments based on various NEMA rating Milbank offers.

## ENCLOSED CONTROLS



Milbank doesn't just build empty enclosures. We can deliver the entire package, complete with custom control equipment built to your exact specifications by our engineers. Milbank commercial pedestals are an attractive, secure, easy to install and cost-effective solution when underground remote site power distribution and control equipment is required, replacing unsightly and inefficient strut and backboard structures.



Please consult serving utility for their requirements prior to ordering or installing, as specifications and approvals vary by utility, and may require local electrical inspector approval. All installations must be installed by a licensed electrician and must comply with all national and local codes, laws and regulations. Milbank reserves the right to make changes in specifications and features shown without notice or obligation.

## Air Conditioner Disconnects

30-60 Amps AC disconnects .....	5
60 Amps AC disconnect with 20 Amps GFCI receptacle.....	6
Hot tub disconnects.....	7

## Single Position Sockets

125 Amps, 4 & 5 terminal, ringless.....	8
200 Amps, 4 & 5 terminal, ringless.....	9
125 Amps, 5 & 7 terminal, lever bypass, ringless .....	10
200 Amps, 4 & 5 terminal, lever bypass, ringless .....	11
200 Amps, 7 terminal, lever bypass, ringless.....	12
320 Amps, 4 terminal, lever bypass, ringless.....	13
320 Amps, 5 terminal, lever bypass, ringless.....	14
320 Amps, 7 terminal, lever bypass, ringless.....	15
600 Amps (480A continuous), 4 & 7 terminal, bolt-in bypass, ringless .....	16

## Meter Mains

60 Amps 4 & 5 terminal, ringless, disconnect combo .....	18
100-200 Amps, 4 terminal, ringless .....	19
100-200 Amps, 4 terminal, with load center, ringless.....	20
320 Amps, 4 terminal, with and without load center, ringless.....	21
320 Amps, 4 terminal, with load center, ringless.....	22
400 Amps, 4 & 7 terminal, ringless.....	23

## Multi-Position

100 Amps, 4 terminal, ringless .....	24
150 Amps, 4 terminal, ringless .....	25
200 Amps, 4 terminal, ringless .....	26
200 Amps, 5 terminal, ringless, Heavy Duty Lever Bypass.....	27
200 Amps, 7 terminal, ringless, Heavy Duty Lever Bypass.....	28

## Multi-Position Meter Mains

100 & 200 Amps, 4 terminal, ringless.....	29-32
---	-------

## Temporary Power

100 & 200 Amps, 4 terminal, ringless.....	33
---	----

## Pedestals

100-200 Amps, 4 terminal, meter main with load center pedestal .....	34-37
--	-------

## Miscellaneous

Replacement parts & Accessories.....	38-41
Enclosed Controls.....	42-51
Reference information .....	52-55

Please consult serving utility for their requirements prior to ordering or installing, as specifications and approvals vary by utility, and may require local electrical inspector approval. All installations must be installed by a licensed electrician and must comply with all national and local codes, laws and regulations. Milbank reserves the right to make changes in specifications and features shown without notice or obligation.



# Catalog Number Logic

How our product catalog numbers are derived

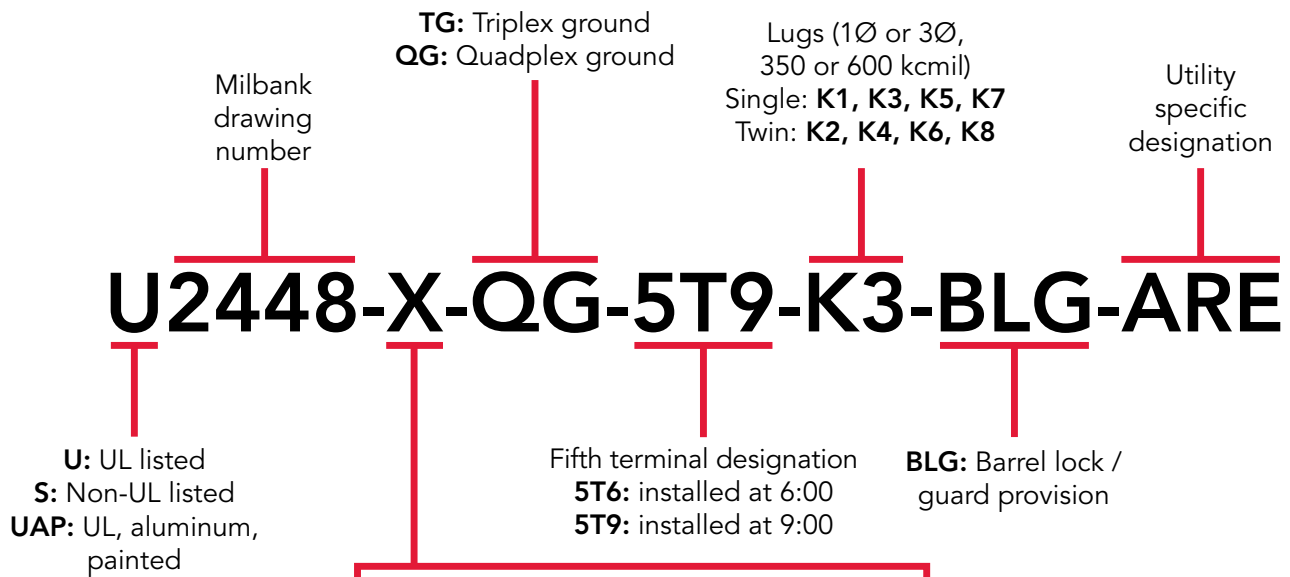

**Hub Openings & Closing Plates**

-O	Blank top	-PXL	Closing plate packed inside
-RL	Small hub opening	-WL	1" hub
-R	Large hub opening	-YL	1¼" hub
-XL	Small closing plate	-ZL	1½" hub
-XT	(2) Large closing plates	-DL	2" hub
-XTL	(2) Small closing plates	-EL	2½" hub
-X	Large closing plate	-F	3" hub
-RXL	Large hub opening adapted to small closing plate	-G	3½" hub
-RRL	Large hub opening adapted to small hub opening	-H	4" hub

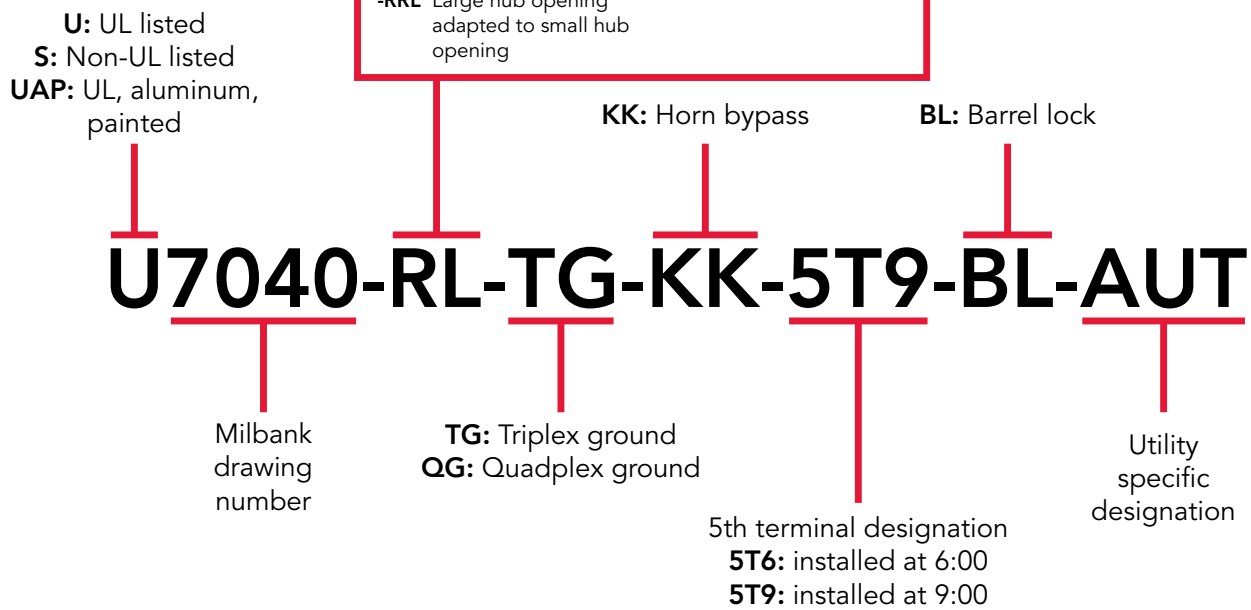

Please consult serving utility for their requirements prior to ordering or installing, as specifications and approvals vary by utility, and may require local electrical inspector approval. All installations must be installed by a licensed electrician and must comply with all national and local codes, laws and regulations. Milbank reserves the right to make changes in specifications and features shown without notice or obligation.

# Air Conditioner Disconnects

30-60 Amps | Fusible & Non-Fusible



**U3802**



**U3812**



**U3832**

Milbank's air conditioner disconnect has a removable hinged cover that makes wiring a breeze. Our compact design meets all wire bending space requirements in the NEC and, also, complies with Article 440-14 in the NEC. To ensure the safest conditions, we designed our disconnect pullouts to be removable so they may be reinstalled in the off position. Another safety feature is the padlock provision on the front cover. As with all Milbank products, our enclosure is constructed of G90U galvanized steel and finished with an attractive, light gray, baked powder coating. Our state of the art finish combines epoxy and polyester hybrid resins into a hybrid powder coating which is then electrostatically applied. This offers a durable, nonfading finish.

## 30-60 Amps | 1Ø 240 VAC | Air Conditioner Disconnects

Catalog Number	Amps	Type	Max H.P.	Weight (lbs.)	Line/Load Wire Range		Ground Wire Range CU/AL	Dimensions			Wire Rating	
					CU	AL		D"	W"	H"	CU °C	AL °C
<b>U3802</b>	60	Non-Fusible	10	3.25	#14-#2	#12-#2	#14-4	2½	5	7½	60°/75°	60°/75°
<b>U3812</b>	60	Non-Auto	10	3.25	#14-#2	#12-#2	#14-4	2½	5	7½	60°/75°	60°/75°
<b>U3832</b>	30	Fusible	3	2.5	#14-#3	#14-#3	#14-3	2½	5	7	60°/75°	60°/75°
<b>U3862</b>	60	Fusible	10	3.3	#14-#3	#14-#3	#14-3	2½	5	9	60°/75°	60°/75°

### Notes

- UL listed as Enclosed Pullout Switch
- Type 3R weather resistant
- One-inch concentric knockouts

Please consult serving utility for their requirements prior to ordering or installing, as specifications and approvals vary by utility, and may require local electrical inspector approval. All installations must be installed by a licensed electrician and must comply with all national and local codes, laws and regulations. Milbank reserves the right to make changes in specifications and features shown without notice or obligation.



# 6

## Air Conditioner Disconnects

60 Amps | With 20 Amps GFCI Receptacle



**U3822-20GWR**

### Specifications

- Meets NEC #210.63 requirements
- UL listed as Power Outlet
- Type 3R weather resistant
- In-use cover\*
- Duplex ground connector
- One-inch concentric knockouts
- 1Ø, 240 volt
- 60 Amps, non-fused
- 20 Amps GFCI receptacle
- Reset/test button
- Meets NEC #406.8 requirements

### 60 Amps | 1Ø, 240 VAC | Air Conditioner Disconnect with GFCI Receptacle

Catalog Number	Type	Max H.P.	Weight (lbs.)	Line/Load Wire Range		Ground Wire Range CU/AL	Dimensions			Wire Rating	
				CU	AL		D"	W"	H"	CU °C	AL °C
U3822-20GWR	Non-Fusible	10	6	#14-#2	#12-#2	#14-4	4 <sup>1</sup> / <sub>8</sub>	5 <sup>1</sup> / <sub>4</sub>	7 <sup>3</sup> / <sub>8</sub>	60°/75°	60°/75°

### Notes

- **Disconnect Pullouts:** To ensure the safest conditions, Milbank disconnect pullouts are reversible so they may be reinstalled in the OFF position.
- **Padlock Provision:** All units are designed with a padlock provision on the cover for security.
- **\*In-Use Cover:** Cover is rated as an in-use cover (cover may be closed with cords plugged into receptacle).



Please consult serving utility for their requirements prior to ordering or installing, as specifications and approvals vary by utility, and may require local electrical inspector approval. All installations must be installed by a licensed electrician and must comply with all national and local codes, laws and regulations. Milbank reserves the right to make changes in specifications and features shown without notice or obligation.



# Hot Tub Disconnects

## Type 3R Enclosures



U4881-O-50GB



U4881-O-60GB

### Specifications

- 240 volt ground fault protection
- UL listed
- Type 3R weather resistant
- 2-pole, 50 or 60 Amps GFCI breaker protection
- Compact size
- Three or four wire installation
- 1Ø, 120/240 VAC
- Standard package of 12
- Two extra one-pole breaker spaces
- 100 Amps overall rating
- Easy to install

### 100 Amps | Hot Tub Disconnect or Sub Panel Breaker Enclosure | Type 3R

Catalog Number	Breaker Amps	Type	Weight (lbs.)	Line/Load Wire Range		Ground Wire Range CU/AL	Dimensions		
				CU	AL		D"	W"	H"
U4881-O	—	Breaker Provision	7	#14-1/0	#14-1/0	#14-1/0	3¾	7½	8½
U4881-O-50GB	50	Breaker	8	#14-1/0	#14-1/0	#14-1/0	3¾	7½	8½
U4881-O-60GB	60	Breaker	8	#14-1/0	#14-1/0	#14-1/0	3¾	7½	8½

Please consult serving utility for their requirements prior to ordering or installing, as specifications and approvals vary by utility, and may require local electrical inspector approval. All installations must be installed by a licensed electrician and must comply with all national and local codes, laws and regulations. Milbank reserves the right to make changes in specifications and features shown without notice or obligation.



# Single Position Sockets

125 Amps | 4 & 5 Terminal | Ringless | 600 VAC



**U8435-XL-TG-HSP**

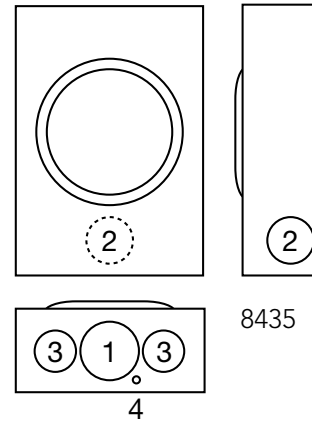

**125 Amps | 4 Terminal | Ringless | Single Position | 1Ø3W**

Catalog Number	Material	Service	Hub	Connectors CU/AL		Bypass	Dimensions			Knockouts			
				Line	Load		D"	W"	H"	1	2	3	4
U8435-XL-TG-HSP	Steel	OH	C.P.	#6-2/0	#6-2/0	None	3 <sup>5</sup> / <sub>16</sub>	8	11 <sup>1</sup> / <sub>2</sub>	2	1 <sup>1</sup> / <sub>2</sub>	1 <sup>1</sup> / <sub>4</sub>	1 <sup>1</sup> / <sub>4</sub>
UAP8435-XL-TG-HSP	Aluminum	OH	C.P.	#6-2/0	#6-2/0	None	3 <sup>5</sup> / <sub>16</sub>	8	11 <sup>1</sup> / <sub>2</sub>	2	1 <sup>1</sup> / <sub>2</sub>	1 <sup>1</sup> / <sub>4</sub>	1 <sup>1</sup> / <sub>4</sub>

**125 Amps | 5 Terminal | Ringless | Single Position | 1Ø3W**

Catalog Number	Material	Service	Hub	Connectors CU/AL		Bypass	Dimensions			Knockouts			
				Line	Load		D"	W"	H"	1	2	3	4
U8435-XL-TG-5T-HSP	Steel	OH	C.P.	#6-2/0	#6-2/0	None	3 <sup>5</sup> / <sub>16</sub>	8	11 <sup>1</sup> / <sub>2</sub>	2	1 <sup>1</sup> / <sub>2</sub>	1 <sup>1</sup> / <sub>4</sub>	1 <sup>1</sup> / <sub>4</sub>
UAP8435-XL-TG-5T-HSP	Aluminum	OH	C.P.	#6-2/0	#6-2/0	None	3 <sup>5</sup> / <sub>16</sub>	8	11 <sup>1</sup> / <sub>2</sub>	2	1 <sup>1</sup> / <sub>2</sub>	1 <sup>1</sup> / <sub>4</sub>	1 <sup>1</sup> / <sub>4</sub>

**Notes**

- **Fifth Terminal:** For field-installed fifth terminal, order catalog number **5T8K2**.
- **Connectors:** Extruded aluminum connectors are tin plated. Units are supplied with a triplex ground.
- **Hubs:** For proper hub selection, see hub suffix chart on accessories page.



Please consult serving utility for their requirements prior to ordering or installing, as specifications and approvals vary by utility, and may require local electrical inspector approval. All installations must be installed by a licensed electrician and must comply with all national and local codes, laws and regulations. Milbank reserves the right to make changes in specifications and features shown without notice or obligation.



# Single Position Sockets

200 Amps | 4 & 5 Terminal | Ringless | 600 VAC



U7021-RL-TG-HSP

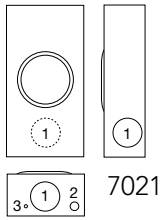

U3850-XL-TG-HSP-PL

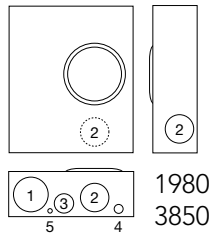

U1980-O-HSP



U7040-O-TG-HSP

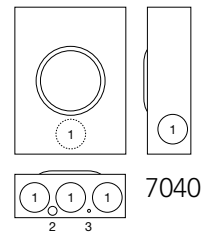

200 Amps | 4 Terminal | Ringless | Single Position | 1Ø3W

Catalog Number	Material	Service	Hub	Connectors CU/AL		Bypass	Dimensions			Knockouts				
				Line	Load		D"	W"	H"	1	2	3	4	5
U7021-RL-TG-HSP	Steel	OH	H.O.	#6-350	#6-350	None	4½	8	15½	2½	¼, ½	¼	—	—
UAP7021-RL-TG-HSP	Aluminum	OH	H.O.	#6-350	#6-350	None	4½	8	15½	2½	¼, ½	¼	—	—
U3850-XL-TG-HSP-PL	Steel	OH/UG	C.P.	#6-350	#6-350	None	4½	13	15¼	3	2½	1½	¼, ½	¼
U7040-XL-TG-HSP	Steel	OH/UG	C.P.	#6-350	#6-350	None	4½	11	14¾	2½	¼, ½	¼	—	—
UAP7040-XL-TG-HSP	Aluminum	OH/UG	C.P.	#6-350	#6-350	None	4½	11	15½	2½	¼, ½	¼	—	—
U7040-O-TG-HSP	Steel	UG	Blank	#6-350	#6-350	None	4½	11	14¾	2½	¼, ½	¼	—	—
UAP7040-O-TG-HSP	Aluminum	UG	Blank	#6-350	#6-350	None	4½	11	15½	2½	¼, ½	¼	—	—
U1980-O-HSP	Steel	UG	Blank	#6-350	#6-350	None	4½	13	15¼	3	2½	1½	¼, ½	¼

200 Amps | 5 Terminal | Ringless | Single Position | 1Ø3W

Catalog Number	Material	Service	Hub	Connectors CU/AL		Bypass	Dimensions			Knockouts				
				Line	Load		D"	W"	H"	1	2	3	4	5
U7040-XL-TG-5T-HSP	Steel	OH/UG	C.P.	#6-350	#6-350	None	4½	11	14¾	2½	¼, ½	¼	—	—
UAP7040-XL-TG-5T-HSP	Aluminum	OH/UG	C.P.	#6-350	#6-350	None	4½	11	15½	2½	¼, ½	¼	—	—
U1980-O-5T-HSP	Aluminum	UG	Blank	#6-350	#6-350	None	4½	13	15¼	3	2½	1½	¼, ½	¼

## Notes

- **Hubs:** For proper hub selection, see the hub suffix chart on the accessories page.
- **Fifth Terminal:** For field-installed fifth terminal, order catalog number **K5T**.
- **Connectors:** Extruded aluminum connectors are tin plated. Units are supplied with a triplex ground.

Please consult serving utility for their requirements prior to ordering or installing, as specifications and approvals vary by utility, and may require local electrical inspector approval. All installations must be installed by a licensed electrician and must comply with all national and local codes, laws and regulations. Milbank reserves the right to make changes in specifications and features shown without notice or obligation.



# 1 □

# Single Position Lever Bypass

125 Amps | 5 & 7 Terminal | Ringless | 600 VAC

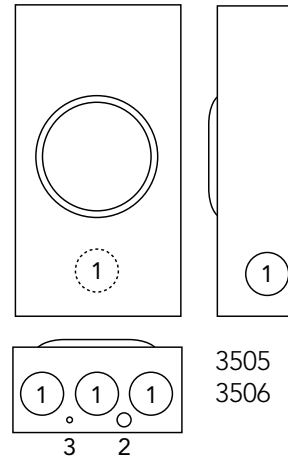

**U3505-XL-TG-HSP**

125 Amps | Ringless | Lever Bypass | Single Position | 1Ø3W

Catalog Number	Material	Terminal	Service	Hub	Connectors CU/AL		Bypass	Dimensions			Knockouts		
					Line	Load		D"	W"	H"	1	2	3
U3505-XL-TG-HSP	Steel	5	OH/UG	C.P.	#6-2/0	#6-2/0	Lever	4 $\frac{7}{8}$	10	18 $\frac{1}{2}$	2	¼, ½	¼
UAP3505-XL-TG-HSP	Aluminum	5	OH/UG	C.P.	#6-2/0	#6-2/0	Lever	4 $\frac{7}{8}$	10	18 $\frac{1}{2}$	2	¼, ½	¼

125 Amps | Ringless | Lever Bypass | Single Position | 3Ø4W

Catalog Number	Material	Terminal	Service	Hub	Connectors CU/AL		Bypass	Dimensions			Knockouts		
					Line	Load		D"	W"	H"	1	2	3
U3506-XL-TG-HSP	Steel	7	OH/UG	C.P.	#6-2/0	#6-2/0	Lever	4 $\frac{7}{8}$	10	18 $\frac{1}{2}$	2	¼, ½	¼
UAP3506-XL-TG-HSP	Aluminum	7	OH/UG	C.P.	#6-2/0	#6-2/0	Lever	4 $\frac{7}{8}$	10	18 $\frac{1}{2}$	2	¼, ½	¼

## Notes

- **Hubs:** For proper hub selection, see the hub suffix chart on the accessories page.
- **Lever Bypass:** The lever supplies clamping action and operates bypass device.
- **Connectors:** Extruded aluminum connectors are tin plated.



Please consult serving utility for their requirements prior to ordering or installing, as specifications and approvals vary by utility, and may require local electrical inspector approval. All installations must be installed by a licensed electrician and must comply with all national and local codes, laws and regulations. Milbank reserves the right to make changes in specifications and features shown without notice or obligation.

# Single Position Lever Bypass

1 1

200 Amps | 4 & 5 Terminal | Ringless | 600 VAC



U9801-X-HSP

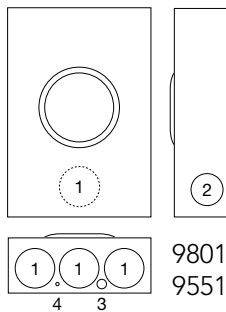

U9550-RRL-QG-HSP

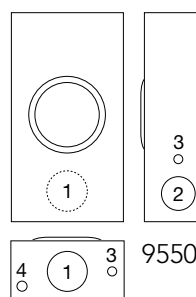

U9551-X-QG-HSP

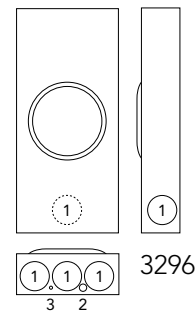

200 Amps | Ringless | Lever Bypass | Single Position | 1Ø3W

Catalog Number	Material	Terminal	Service	Hub	Connectors CU/AL	Bypass	Dimensions			Knockouts				
							D"	W"	H"	1	2	3	4	
U9801-X-QG-HSP	Steel	4	OH/UG	C.P.	#6-350	Lever	4 <sup>7</sup> / <sub>8</sub>	13	19	3	2 <sup>1</sup> / <sub>2</sub>	1 <sup>1</sup> / <sub>4</sub> , 1 <sup>1</sup> / <sub>2</sub>	1 <sup>1</sup> / <sub>4</sub>	
U9550-RRL-QG-HSP	Steel	5	OH	H.O.	#6-350	Lever	4 <sup>7</sup> / <sub>8</sub>	10	18 <sup>1</sup> / <sub>2</sub>	3	2 <sup>1</sup> / <sub>2</sub>	1 <sup>1</sup> / <sub>4</sub> , 1 <sup>1</sup> / <sub>2</sub>	1 <sup>1</sup> / <sub>4</sub>	
U9551-X-QG-HSP	Steel	5	OH/UG	C.P.	#6-350	Lever	4 <sup>7</sup> / <sub>8</sub>	13	19	3	2 <sup>1</sup> / <sub>2</sub>	1 <sup>1</sup> / <sub>4</sub> , 1 <sup>1</sup> / <sub>2</sub>	1 <sup>1</sup> / <sub>4</sub>	
UAP9551-X-QG-HSP	Aluminum	5	OH/UG	C.P.	#6-350	Lever	4 <sup>7</sup> / <sub>8</sub>	13	19	3	2 <sup>1</sup> / <sub>2</sub>	1 <sup>1</sup> / <sub>4</sub> , 1 <sup>1</sup> / <sub>2</sub>	1 <sup>1</sup> / <sub>4</sub>	
U3296-X-HSP	Steel	5	OH/UG	C.P.	3/8" x 16 Studs	Lever	4 <sup>7</sup> / <sub>8</sub>	13	28 <sup>1</sup> / <sub>4</sub>	3	1 <sup>1</sup> / <sub>4</sub> , 1 <sup>1</sup> / <sub>2</sub>	1 <sup>1</sup> / <sub>4</sub>	—	
UAP3296-X-HSP	Aluminum	5	OH/UG	C.P.	3/8" x 16 Studs	Lever	4 <sup>7</sup> / <sub>8</sub>	13	28 <sup>1</sup> / <sub>4</sub>	3	1 <sup>1</sup> / <sub>4</sub> , 1 <sup>1</sup> / <sub>2</sub>	1 <sup>1</sup> / <sub>4</sub>	—	

## Notes

- **Hubs:** For proper hub selection, see the hub suffix chart on the accessories page.
- **Lever Bypass:** The lever supplies clamping action and operates bypass device.
- **Fifth Terminal:** For field installed fifth terminal on the **U9801**, order **K3866**.
- **Connectors:** Extruded aluminum connectors are tin plated. For the **U3296-X** stud-type unit, order connector kits separately. Order two kits to cover both line and load side: **K1539** (350 kcmil) or **K1540** (600 kcmil.) See accessories page.

Please consult serving utility for their requirements prior to ordering or installing, as specifications and approvals vary by utility, and may require local electrical inspector approval. All installations must be installed by a licensed electrician and must comply with all national and local codes, laws and regulations. Milbank reserves the right to make changes in specifications and features shown without notice or obligation.



# Single Position Lever Bypass

200 Amps | 7 Terminal | Ringless | 600 VAC



U9700-RRL-QG-HSP



U9701-X-QG-HSP



U3306-X-HSP

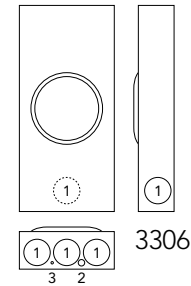
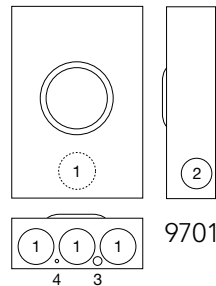
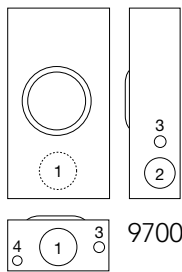

200 Amps | 7 Terminal | Ringless | Lever Bypass | Single Position | 3Ø4W

Catalog Number	Material	Terminal	Service	Hub	Connectors CU/AL	Bypass	Dimensions			Knockouts			
							D"	W"	H"	1	2	3	4
U9700-RRL-QG-HSP	Steel	7	OH	H.O.	#6-350	Lever	4 <sup>7</sup> / <sub>8</sub>	10	18 <sup>1</sup> / <sub>2</sub>	3	2 <sup>1</sup> / <sub>2</sub>	<sup>3</sup> / <sub>4</sub>	<sup>1</sup> / <sub>4</sub> , <sup>1</sup> / <sub>2</sub>
UAP9700-RRL-QG-HSP	Aluminum	7	OH	H.O.	#6-350	Lever	4 <sup>7</sup> / <sub>8</sub>	10	18 <sup>1</sup> / <sub>2</sub>	3	2 <sup>1</sup> / <sub>2</sub>	<sup>3</sup> / <sub>4</sub>	<sup>1</sup> / <sub>4</sub> , <sup>1</sup> / <sub>2</sub>
U9701-X-QG-HSP	Steel	7	OH/UG	C.P.	#6-350	Lever	4 <sup>7</sup> / <sub>8</sub>	13	19	3	2 <sup>1</sup> / <sub>2</sub>	<sup>1</sup> / <sub>4</sub> , <sup>1</sup> / <sub>2</sub>	<sup>1</sup> / <sub>4</sub>
UAP9701-X-QG-HSP	Aluminum	7	OH/UG	C.P.	#6-350	Lever	4 <sup>7</sup> / <sub>8</sub>	13	19	3	2 <sup>1</sup> / <sub>2</sub>	<sup>1</sup> / <sub>4</sub> , <sup>1</sup> / <sub>2</sub>	<sup>1</sup> / <sub>4</sub>
U3306-X-HSP	Steel	7	OH/UG	C.P.	<sup>3</sup> / <sub>8</sub> " x 16 Studs	Lever	4 <sup>7</sup> / <sub>8</sub>	13	28 <sup>1</sup> / <sub>4</sub>	3	<sup>1</sup> / <sub>4</sub> , <sup>1</sup> / <sub>2</sub>	<sup>1</sup> / <sub>4</sub>	—
UAP3306-X-HSP	Aluminum	7	OH/UG	C.P.	<sup>3</sup> / <sub>8</sub> " x 16 Studs	Lever	4 <sup>7</sup> / <sub>8</sub>	13	28 <sup>1</sup> / <sub>4</sub>	3	<sup>1</sup> / <sub>4</sub> , <sup>1</sup> / <sub>2</sub>	<sup>1</sup> / <sub>4</sub>	—

## Notes

- **Hubs:** For proper hub selection, see the hub suffix chart on the accessories page.
- **Lever Bypass:** The lever supplies clamping action and operates bypass device.
- **Isolated Neutral:** For field-installed isolated neutral for **U9701**, order **K1047**.
- **Connectors:** Extruded aluminum connectors are tin plated. For the **U3306** stud-type unit, order connector kits separately. Order 2 kits to cover both line and load side: **K3082** (350 kcmil) or **K3441** (600 kcmil.) See accessories page.



Please consult serving utility for their requirements prior to ordering or installing, as specifications and approvals vary by utility, and may require local electrical inspector approval. All installations must be installed by a licensed electrician and must comply with all national and local codes, laws and regulations. Milbank reserves the right to make changes in specifications and features shown without notice or obligation.

# Single Position Lever Bypass

1 3

320 Amps | 4 Terminal | Ringless | 600 VAC



U4363-X-HSP    U6273-X-HSP    U6272-X-HSP    U1129-O-K3L-K2L-HSP    U1797-O-K3L-K2L-HSP    U2124-O-HSP

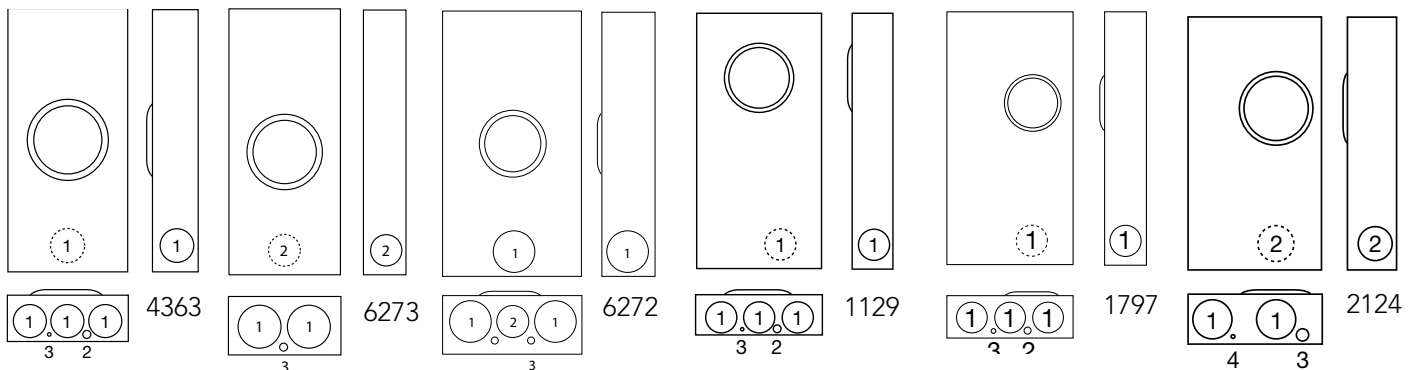

320 Amps | 4 Terminal | Ringless | Lever Bypass | Single Position | 1Ø3W

Catalog Number	Material	Service	Hub	Connectors CU/AL		Dimensions			Knockouts			
				Line	Load	D"	W"	H"	1	2	3	4
U4363-X-HSP	Steel	OH	C.P.	3/8" x 16 Studs	3/8" x 16 Studs	4 <sup>27</sup> / <sub>32</sub>	13	28 <sup>1</sup> / <sub>4</sub>	3	1/2	1/4	—
U6273-X-HSP	Steel	OH	C.P.	3/8" x 16 Studs	3/8" x 16 Studs	6	13	28 <sup>1</sup> / <sub>4</sub>	4	3	—	—
U6272-X-HSP	Steel	OH/UG	C.P.	3/8" x 16 Studs	3/8" x 16 Studs	6	16	28 <sup>1</sup> / <sub>4</sub>	4	3	—	—
UAP6272-X-HSP	Aluminum	OH/UG	C.P.	3/8" x 16 Studs	3/8" x 16 Studs	6	16	28 <sup>1</sup> / <sub>4</sub>	4	3	—	—
U1129-O-K3L-K2L-HSP	Steel	UG	Blank	(1) #4-600 or (2) 1/0-250	(2) #6-350	4 <sup>7</sup> / <sub>8</sub>	15	30	3	1/2	1/4	—
U1797-O-K3L-K2L-HSP	Steel	UG	Blank	(1) #4-600 or (2) 1/0-250	(2) #6-350	4 <sup>27</sup> / <sub>32</sub>	15	30	3	1/2	1/4	—
U2124-O-HSP	Steel	UG	Blank	3/8" x 16 Studs	3/8" x 16 Studs	5 <sup>3</sup> / <sub>4</sub>	16	32	4	3 <sup>1</sup> / <sub>2</sub>	1	1/4
UAP2124-O-HSP	Aluminum	UG	Blank	3/8" x 16 Studs	3/8" x 16 Studs	5 <sup>3</sup> / <sub>4</sub>	16	32	4	3 <sup>1</sup> / <sub>2</sub>	1	1/4

## Notes

- **Hubs:** For proper hub selection, see the hub suffix chart on the accessories page.
- **Lever Bypass:** The lever supplies clamping action and operates bypass device.
- **Connectors:** Extruded aluminum connectors are tin plated. Order two connector kits to cover both line and load. See accessories page.

Please consult serving utility for their requirements prior to ordering or installing, as specifications and approvals vary by utility, and may require local electrical inspector approval. All installations must be installed by a licensed electrician and must comply with all national and local codes, laws and regulations. Milbank reserves the right to make changes in specifications and features shown without notice or obligation.



# 1 4

## Lever Bypass Single Position

320 Amps | 5 Terminal | Ringless | 600 VAC

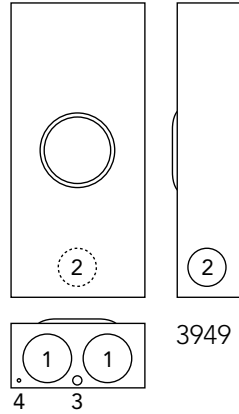

3949

U3949-X-HSP

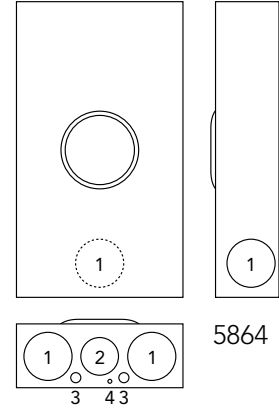

5864

U5864-X-HSP

320 Amps | 5 Terminal | Ringless | Lever Bypass | Single Position | 1Ø3W

Catalog Number	Material	Terminal	Service	Hub	Connectors CU/AL	Bypass	Dimensions			Knockouts			
							D"	W"	H"	1	2	3	4
U3949-X-HSP	Steel	5	OH	C.P.	3/8" x 16 Studs	Lever	6	13	28 1/4	4	3	1/4, 1/2	1/4
UAP3949-X-HSP	Aluminum	5	OH	C.P.	3/8" x 16 Studs	Lever	6	13	28 1/4	4	3	1/4, 1/2	1/4
U5864-X-HSP	Steel	5	OH/UG	C.P.	3/8" x 16 Studs	Lever	6	16	28 1/4	4	3	1/4, 1/2	1/4
UAP5864-X-HSP	Aluminum	5	OH/UG	C.P.	3/8" x 16 Studs	Lever	6	16	28 1/4	4	3	1/4, 1/2	1/4

### Notes

- **Hubs:** For proper hub selection, see the hub suffix chart on the accessories page.
- **Lever Bypass:** The lever supplies clamping action and operates bypass device.
- **Connectors:** Extruded aluminum connectors are tin plated. Order two connector kits to cover both line and load. See accessories page.
- **U5864:** The U5864 will not accept twin lugs (the K1540 connector will accept 2 conductors 1/0–250 max).



Please consult serving utility for their requirements prior to ordering or installing, as specifications and approvals vary by utility, and may require local electrical inspector approval. All installations must be installed by a licensed electrician and must comply with all national and local codes, laws and regulations. Milbank reserves the right to make changes in specifications and features shown without notice or obligation.



# Lever Bypass Single Position

320 Amps | 7 Terminal | Ringless | 600 VAC



U3566-X-HSP

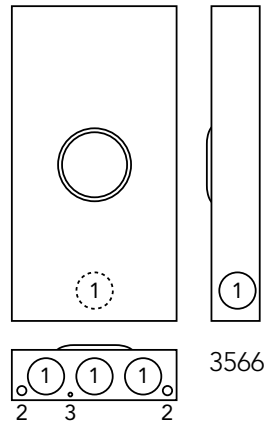

U2120-O-HSP

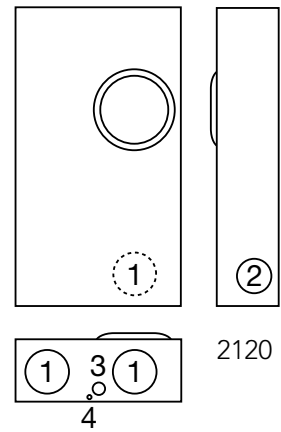

320 Amps | 7 Terminal | Ringless | Lever Bypass | Single Position | 3Ø4W

Catalog Number	Material	Terminal	Service	Hub	Connectors CU/AL	Bypass	Dimensions			Knockouts			
							D"	W"	H"	1	2	3	4
U3566-X-HSP	Steel	7	OH/UG	C.P.	½" x 13 Studs	Lever	6	20¼	38¾	4	3	¼, ½	¼
UAP3566-X-HSP	Aluminum	7	OH/UG	C.P.	½" x 13 Studs	Lever	6	20¼	38¾	4	3	¼, ½	¼
U2120-O-HSP	Steel	7	UG	Blank	¾" x 16 Studs	Lever	6½	17¾	31¾	4	3	1	¼

## Notes

- **Hubs:** For proper hub selection, see the hub suffix chart on the accessories page.
- **Lever Bypass:** The lever supplies clamping action and operates bypass device.
- **Connectors:** Extruded aluminum connectors are tin plated. Order two connector kits to cover both line and load. See accessories page.
- **U3566:** The U3566 will accept an isolated neutral kit K6024.
- 1/2" stud lug kits **K4223** two position #6-350 kcmil or **K4200** for a single wire #4-600 or (2) 1/0-250 kcmil

Please consult serving utility for their requirements prior to ordering or installing, as specifications and approvals vary by utility, and may require local electrical inspector approval. All installations must be installed by a licensed electrician and must comply with all national and local codes, laws and regulations. Milbank reserves the right to make changes in specifications and features shown without notice or obligation.



# 16

# Bolt-In Bypass Single Position

600 Amps (480A Cont.) | 7 Terminal | Ringless | *FPL approved only*



U4667-X-8528

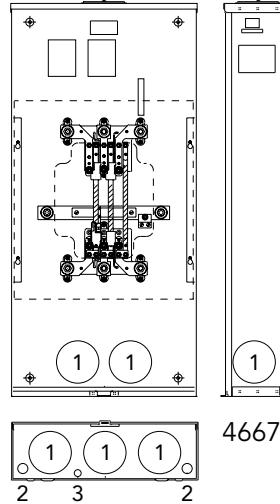

4667

600 Amps(480A Cont.) | Ringless | Bolt-In Bypass | Single Position | **FPL Only**

Catalog Number	Approved Utilities	Material	Terminal	Hub	Ground Lug	Dimensions			Knockouts		
						D"	W"	H"	1	2	3
U4667-X-8528	FP&L	Steel	7	C.P.	1/0-2/0	6	20¼	43	4	½,¾	¼
UA4667-X-8529	FP&L	Aluminum	7	C.P.	1/0-2/0	6	20¼	43	4	½,¾	¼
U4667-XT-9526	FP&L	Steel	7	(2) C.P.	1/0-2/0	6	20¼	43	4	½,¾	¼
UA4667-XT-9527	FP&L	Aluminum	7	(2) C.P.	1/0-2/0	6	20¼	43	4	½,¾	¼

## Notes

- **Hubs:** The -X unit is supplied with a large closing plate in the top. The -XT units are supplied with 2 large closing plates in the top. For proper hub selection, see the hub suffix chart on the accessories page.
- **Isolated Neutral Kit:** For an isolated neutral on the 7-terminal sockets, order catalog number **Z708312-MO**.
- **Connectors:** The 4-terminal units require a total of 5 connectors. The 7-terminal units require a total of 8 connectors. The 7-terminal units are supplied with two ground lugs. Order line and load connectors as extra. See chart on next page for ordering information.
- **Bolt-In Bypass:** These units offer a provision for a utility-supplied bolt-in bypass.



Please consult serving utility for their requirements prior to ordering or installing, as specifications and approvals vary by utility, and may require local electrical inspector approval. All installations must be installed by a licensed electrician and must comply with all national and local codes, laws and regulations. Milbank reserves the right to make changes in specifications and features shown without notice or obligation.

# Bolt-In Bypass Single Position

## Connector Kits



Z703916-AC

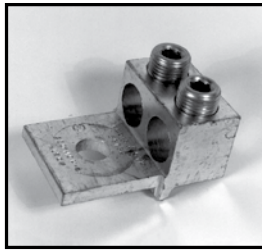

Z703918-AC

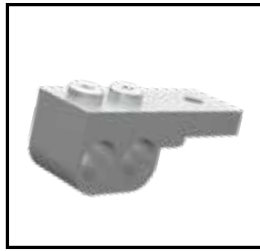

Z703919-AC

Bolt-on type lugs for Milbank stud type meter mounting devices are made of 6061-T6 aluminum to provide high strength and high conductivity. All lugs are tinplated to ensure low contact resistance and to reduce corrosion. Allen or hex head pressure screws are furnished to provide excellent conductor spread for maximum binding action with the lug.

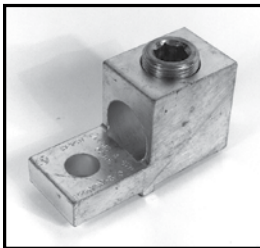

Z703921-AC

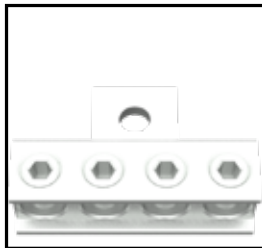

Z705420-AC



Z705456-AC

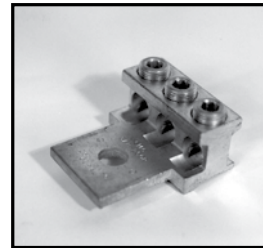

Z708145-AC

### 4 Terminal, 1Ø3W Connector Kits

Catalog Number	Wire Range	Type	Wire Entry
Z703917-AC	#6-350	Twin	Side
Z704693-AC	#2-500	Twin	Side
Z705456-AC	#6-350	Twin	Rear
Z705420-AC	#6-350	Quad	Rear

### 7 Terminal, 3Ø4W Connector Kits

Catalog Number	Wire Range	Type	Wire Entry
Z703916-AC	3/0-800	Single	Side
Z703921-AC	3/0-800	Single	Front
Z703918-AC	#4-350	Twin	Front
Z703919-AC	#6-350	Twin	Side
Z704693-AC	#2-500	Twin	Side
Z704694-AC	#4-500	Twin	Front
Z708145-AC	#6-250	Triple	Front

Please consult serving utility for their requirements prior to ordering or installing, as specifications and approvals vary by utility, and may require local electrical inspector approval. All installations must be installed by a licensed electrician and must comply with all national and local codes, laws and regulations. Milbank reserves the right to make changes in specifications and features shown without notice or obligation.



# 1 Ø Fused & Non-Fused Meter Disconnect Combo

60 Amps | 4 & 5 Terminal | Ringless | 120/240 VAC



U6419

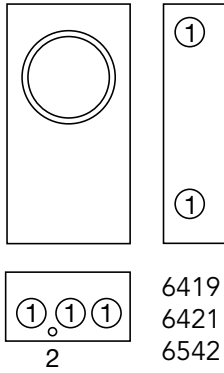

U6542

60 Amps | 4 Terminal | Non-Fused | Ringless | Single Position | 1Ø3W

Catalog Number	Material	Service	Hub	Connectors CU/AL	Bypass	Dimensions			Knockouts	
						D"	W"	H"	1	2
U6419-XL-HSP	Steel	OH	C.P.	#6-350	None	4 <sup>1</sup> / <sub>32</sub>	8	16	1 <sup>1</sup> / <sub>4</sub>	1 <sup>1</sup> / <sub>4</sub>
UAP6419-XL-HSP	Aluminum	OH	C.P.	#6-350	None	4 <sup>1</sup> / <sub>32</sub>	8	16	1 <sup>1</sup> / <sub>4</sub>	1 <sup>1</sup> / <sub>4</sub>
USSP6419-O-HSP	Steel	OH/UG	Blank	#6-350	None	4 <sup>1</sup> / <sub>32</sub>	8	16	1 <sup>1</sup> / <sub>4</sub>	1 <sup>1</sup> / <sub>4</sub>
U6421-XL-HSP	Steel	OH/UG	C.P.	#6-350	Lever	4 <sup>7</sup> / <sub>32</sub>	10	19 <sup>3</sup> / <sub>8</sub>	1 <sup>1</sup> / <sub>4</sub>	1 <sup>1</sup> / <sub>4</sub>
UAP6421-O-HSP	Aluminum	OH/UG	Blank	3/8" x 16 Studs	Lever	4 <sup>7</sup> / <sub>32</sub>	10	19 <sup>3</sup> / <sub>8</sub>	1 <sup>1</sup> / <sub>4</sub>	1 <sup>1</sup> / <sub>4</sub>
USSP6421-O-HSP	Steel	OH/UG	Blank	3/8" x 16 Studs	Lever	4 <sup>7</sup> / <sub>32</sub>	10	19 <sup>3</sup> / <sub>8</sub>	1 <sup>1</sup> / <sub>4</sub>	1 <sup>1</sup> / <sub>4</sub>

60 Amps | 5 Terminal | Fused | Ringless | Lever Bypass | Single Position | 1Ø3W

Catalog Number	Material	Service	Hub	Connectors CU/AL	Bypass	Dimensions			Knockouts		
						D"	W"	H"	1	2	3
U6542-RL-5T9-HSP	Steel	OH/UG	H.O.	#6-350	Lever	4 <sup>7</sup> / <sub>8</sub>	10	23 <sup>3</sup> / <sub>8</sub>	3	1 <sup>1</sup> / <sub>4</sub>	1 <sup>1</sup> / <sub>4</sub>
UAP6542-RL-5T9-HSP	Aluminum	OH/UG	H.O.	#6-350	Lever	4 <sup>7</sup> / <sub>8</sub>	10	23 <sup>3</sup> / <sub>8</sub>	3	1 <sup>1</sup> / <sub>4</sub>	1 <sup>1</sup> / <sub>4</sub>
USSP6542-O-5T9-HSP	Steel	OH/UG	Blank	#6-350	Lever	4 <sup>7</sup> / <sub>8</sub>	10	23 <sup>3</sup> / <sub>8</sub>	3	1 <sup>1</sup> / <sub>4</sub>	1 <sup>1</sup> / <sub>4</sub>

## Notes

- NEMA 3R rated
- Powder-coated galvanized steel, aluminum, or stainless steel
- SCCR Rating of 10K



Please consult serving utility for their requirements prior to ordering or installing, as specifications and approvals vary by utility, and may require local electrical inspector approval. All installations must be installed by a licensed electrician and must comply with all national and local codes, laws and regulations. Milbank reserves the right to make changes in specifications and features shown without notice or obligation.

# Meter Main

100-200 Amps | 4 Terminal | Ringless | 120/240 VAC

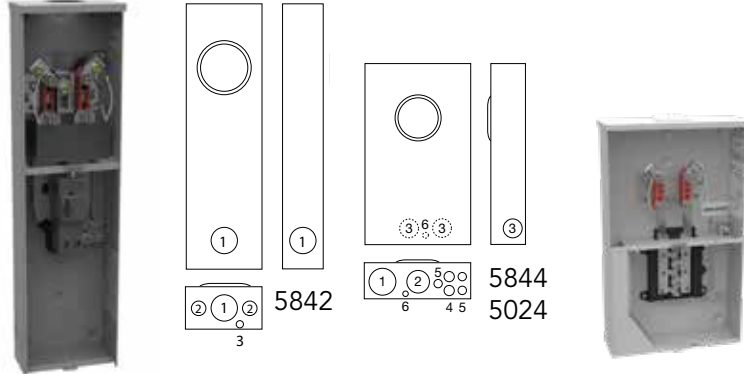

U5842-RL-150-HSP

UAP5024-XL-FMG

Breaker Chart for UAP5024

Manufacturer	Compatible Models	AIC Rating
Siemens	QN, QNR, QP	10K
Cutler-Hammer	BR, HQP, QPGF	10K
G.E.	TQL, THQL-GF	10K
Square D	Homeline	10K

100-200 Amps | 4 Terminal | Ringless | Meter Main | 1Ø3W

Catalog Number	Material	Service	Hub	Connectors CU/AL - Line		Dimensions			Knockouts					
				Line	Load	D"	W"	H"	1	2	3	4	5	
U5842-RL-100-HSP	Steel	OH	C.P.	#6-350	CB	4½	8	30	2	1¼	¼	-	-	-
U5844-RL-100-HSP	Steel	OH/UG	H.O.	#6-350	CB	4½	14	30	3	2½	2	1	¾	½
UAP5844-RL-100-HSP	Aluminum	OH/UG	H.O.	#6-350	CB	4½	14	30	3	2½	2	1	¾	½
U5842-RL-150-HSP	Steel	OH	C.P.	#6-350	CB	4½	8	30	2	1¼	¼	-	-	-
U5844-RL-150-HSP	Steel	OH/UG	H.O.	#6-350	CB	4½	14	30	3	2½	2	1	¾	½
UAP5844-RL-150-HSP	Aluminum	OH/UG	H.O.	#6-350	CB	4½	14	30	3	2½	2	1	¾	½
U5842-RL-200-HSP	Steel	OH	C.P.	#6-350	CB	4½	8	30	2	1¼	¼	-	-	-
U5844-RL-200-HSP	Steel	OH/UG	H.O.	#6-350	CB	4½	14	30	3	2½	2	1	¾	½
UAP5844-RL-200-HSP	Aluminum	OH/UG	H.O.	#6-350	CB	4½	14	30	3	2½	2	1	¾	½

200 Amps | 4 Terminal | Ringless | Meter Main Load Center | 1Ø3W

Catalog Number	Material	Service	Hub	Connectors CU/AL - Line		Dimensions			Knockouts					
				Line	Load	D"	W"	H"	1	2	3	4	5	6
UAP5024-XL-FMG*	Aluminum	OH/UG	C.P.	#6-350	CB	4½	14⅞	24	3	2½	2	1	½,¾	¼,½

## Notes

- **UAP5024 Bussing:** Load side bus bars and circuit breaker interior are made from plated copper.
- **Breakers:** UAP5024 Breaker section has provision for six double pole "plug-in" type circuit breakers. All circuit breakers will be parallel. To comply with NEC wire bending space requirements the maximum breaker amperage is 200 Amps restricted to 3/0 copper conductor.

\*Wireway: Provided with underground pull section wireway with removable cover.

Please consult serving utility for their requirements prior to ordering or installing, as specifications and approvals vary by utility, and may require local electrical inspector approval. All installations must be installed by a licensed electrician and must comply with all national and local codes, laws and regulations. Milbank reserves the right to make changes in specifications and features shown without notice or obligation.



# Meter Main with Load Center

100-200 Amps | 4 Terminal | Ringless | 120/240 VAC

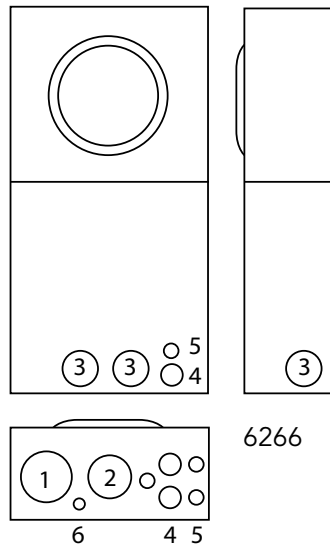

U6266-XTL-100-HSP

100-200 Amps | 4 Terminal | Ringless | Meter Main | 1Ø3W

Catalog Number	Breaker Amps	Material	Service	Hub	Connectors CU/AL - Line	Dimensions			Knockouts					
						D"	W"	H"	1	2	3	4	5	6
U6266-XTL-100-HSP	100	Steel	OH/UG	(2) C.P.	#6-350	4½	14⅞	30	3	2½	2	½	¾	½
U6266-XTL-150-HSP	150	Steel	OH/UG	(2) C.P.	#6-350	4½	14⅞	30	3	2½	2	½	¾	½
U6266-XTL-200-HSP	200	Steel	OH/UG	(2) C.P.	#6-350	4½	14⅞	30	3	2½	2	½	¾	½

## Notes

- **Hubs:** Supplied with two closing plates packed inside. Order hubs as a separate item. For proper hub selection, refer to the hub suffix chart on the accessories page.
- **Fifth Terminal:** For field installed fifth terminal, order **K5T**.
- **Breakers:** 22KAIC main breakers factory installed
- **Main Breaker:** also available with 100-150 Amps breakers, consult factory.
- **Sub Feed Lugs:** #6-350 sub feed lugs provided on 10 circuit interior. **Not available on 20 circuit interior.**
- See accessories page for generator interlock kits.

## Branch Breaker Chart

AIC Rating	Amps	Siemens	Cutler Hammer	General Electric	Square D
10k	150-200	QNR	BR (150A only)	—	—
	≤ 125	QP	HQP, BR	THQL, THQL-GF	Homeline
22k	150-200	QNRH	—	—	—
	≤ 125	QPH	—	—	—



Please consult serving utility for their requirements prior to ordering or installing, as specifications and approvals vary by utility, and may require local electrical inspector approval. All installations must be installed by a licensed electrician and must comply with all national and local codes, laws and regulations. Milbank reserves the right to make changes in specifications and features shown without notice or obligation.



# Meter Main & Meter Main w/ Load Center 2 1

320 Amps | 4 Terminal | Ringless | 120/240 VAC

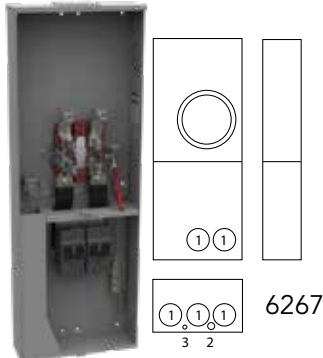

U6267-X-2/200-HSP

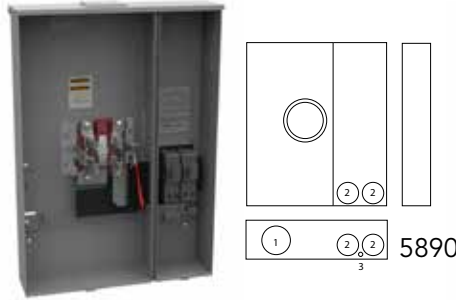

U5890-X-2/200-HSP

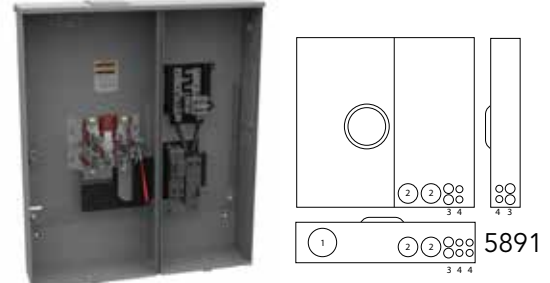

U5891-X-2/200-HSP

## 320 Amps | 4 Terminal | Ringless | Meter Main | 1Ø3W | Lever Bypass

Catalog Number	Material	Service	Hub	Connectors CU/AL - Line		Dimensions			Knockouts		
				Line	Load	D"	W"	H"	1	2	3
*U6267-X-HSP	Steel	OH/UG	C.P.	3/8" x 16 Studs	—	6	15	42½	4	2½	.312
U6267-X-2/150-HSP	Steel	OH/UG	C.P.	3/8" x 16 Studs	CB	6	15	42½	4	2½	.312
U6267-X-2/200-HSP	Steel	OH/UG	C.P.	3/8" x 16 Studs	CB	6	15	42½	4	2½	.312

## 320 Amps | 4 Terminal | Ringless | Meter Main | 1Ø3W | Lever Bypass

Catalog Number	Material	Service	Hub	Connectors CU/AL - Line		Dimensions			Knockouts		
				Line	Load	D"	W"	H"	1	2	3
U5890-X-2/150-HSP	Steel	OH/UG	C.P.	3/8" x 16 Studs	CB	6	24½	35	4	2½	.312
U5890-X-2/200-HSP	Steel	OH/UG	C.P.	3/8" x 16 Studs	CB	6	24½	35	4	2½	.312

## 320 Amps | 4 Terminal | Ringless | Meter Main w/ Load Center | 1Ø3W | Lever Bypass

Catalog Number	Material	Service	Hub	Connectors CU/AL - Line		Dimensions			Knockouts			
				Line	Load	D"	W"	H"	1	2	3	4
U5891-X-2/200-MLK-HSP	Steel	OH/UG	C.P.	3/8" x 16 Studs	CB	6	29½	35	4	2½	1	¾

### Notes

- **HSP:** Has a stainless steel hasp
- **Short Circuit Current Withstand Rating:** 22K AIC standard.
- **Breakers:** Units come with main breakers. \*U6267-X-HSP breaker sold separately.
- **Fifth Terminal:** For field mounted fifth terminal order catalog number K3865.

Please consult serving utility for their requirements prior to ordering or installing, as specifications and approvals vary by utility, and may require local electrical inspector approval. All installations must be installed by a licensed electrician and must comply with all national and local codes, laws and regulations. Milbank reserves the right to make changes in specifications and features shown without notice or obligation.



# 22 Meter Main & Meter Main w/ Load Center

320 Amps | 4 Terminal | Ringless | 120/240 VAC



U6601-X-2/200-5T9-HSP

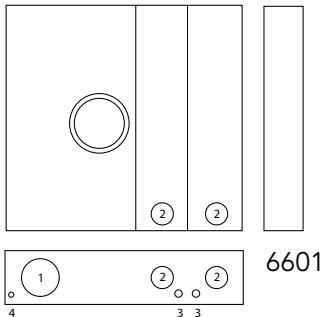

UAP6602-X-2/200-5T9-MLK-HSP

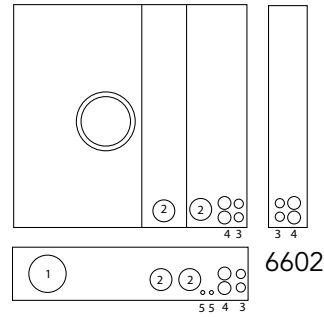

## 320 Amps | 4 Terminal | Ringless | Meter Main | 1Ø3W | Lever Bypass

Catalog Number	Material	Service	Hub	Connectors CU/AL - Line		Dimensions			Knockouts			
				Line	Load	D"	W"	H"	1	2	3	4
U6601-X-2/200-5T9-HSP	Steel	OH/UG	C.P.	3/8" x 16 Studs	CB	6	34 1/4	35	4	2 1/2	1/2	.312
UAP6601-X-2/200-5T9-HSP	Aluminum	OH/UG	C.P.	3/8" x 16 Studs	CB	6	34 1/4	35	4	2 1/2	1/2	.312

## 320 Amps | 4 Terminal | Ringless | Meter Main w/ Load Center | 1Ø3W | Lever Bypass

Catalog Number	Material	Service	Hub	Connectors CU/AL - Line		Dimensions			Knockouts				
				Line	Load	D"	W"	H"	1	2	3	4	5
U6602-X-2/200-MLK-HSP	Steel	OH/UG	C.P.	3/8" x 16 Studs	CB	6	38	41	4	2 1/2	3/4	1	1/2
UAP6602-X-2/200-5T9-MLK-HSP	Aluminum	OH/UG	C.P.	3/8" x 16 Studs	CB	6	38	41	4	2 1/2	3/4	1	1/2

### Notes

- **HSP:** Has a stainless steel hasp
- **Short Circuit Current Withstand Rating:** 22K AIC standard.
- **Breakers:** Units come with main breakers.
- **Fifth Terminal:** For field mounted fifth terminal order catalog number **K3865**.



Please consult serving utility for their requirements prior to ordering or installing, as specifications and approvals vary by utility, and may require local electrical inspector approval. All installations must be installed by a licensed electrician and must comply with all national and local codes, laws and regulations. Milbank reserves the right to make changes in specifications and features shown without notice or obligation.

# Meter Socket with Main

400 Amps | 4 & 7 Terminals | Ringless | 480 VAC



U6115-X-2/200-K7L

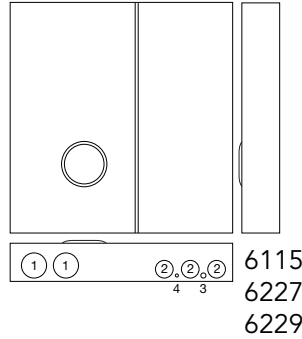

## 400 Amps Meter Main | 7 Terminal | 3Ø4W | Ringless | 480 VAC

Catalog Number	Service	Hub	Connectors CU/AL	Dimensions			Knockouts			
			Line	D"	W"	H"	1	2	3	4
U6115-X-2/200-K7L-HSP	OH/UG	C.P.	#4-600kcmil or (2) 1/0 - 250	7	34¼	34	4	2½	½	¼

## 400 Amps Meter Main | 4 Terminal | 1Ø3W | Ringless | 480 VAC

Catalog Number	Service	Hub	Connectors CU/AL	Dimensions			Knockouts			
			Line	D"	W"	H"	1	2	3	4
U6227-X-400-K3L-HSP	OH/UG	C.P.	#4-600kcmil or (2) 1/0 - 250	6	36¼	34	4	2½	½	¼

## 400 Amps Meter Main | 7 Terminal | 3Ø4W | 480 VAC

Catalog Number	Service	Hub	Connectors CU/AL	Dimensions			Knockouts			
			Line	D"	W"	H"	1	2	3	4
U6229-X-400-K7L-HSP	OH/UG	C.P.	#4-600kcmil or (2) 1/0 - 250	6	36¼	34	4	2½	½	¼

### Specifications

- **AIC Rating: 22K AIC at 240V.** And 10K AIC at 480V
- **300 Amps breaker: U6227 and U6229 only** can be installed from the factory (upon request)

Please consult serving utility for their requirements prior to ordering or installing, as specifications and approvals vary by utility, and may require local electrical inspector approval. All installations must be installed by a licensed electrician and must comply with all national and local codes, laws and regulations. Milbank reserves the right to make changes in specifications and features shown without notice or obligation.



100 Amps | 4 Terminal | Ringless | 300 VAC



U3492-XL-HSP

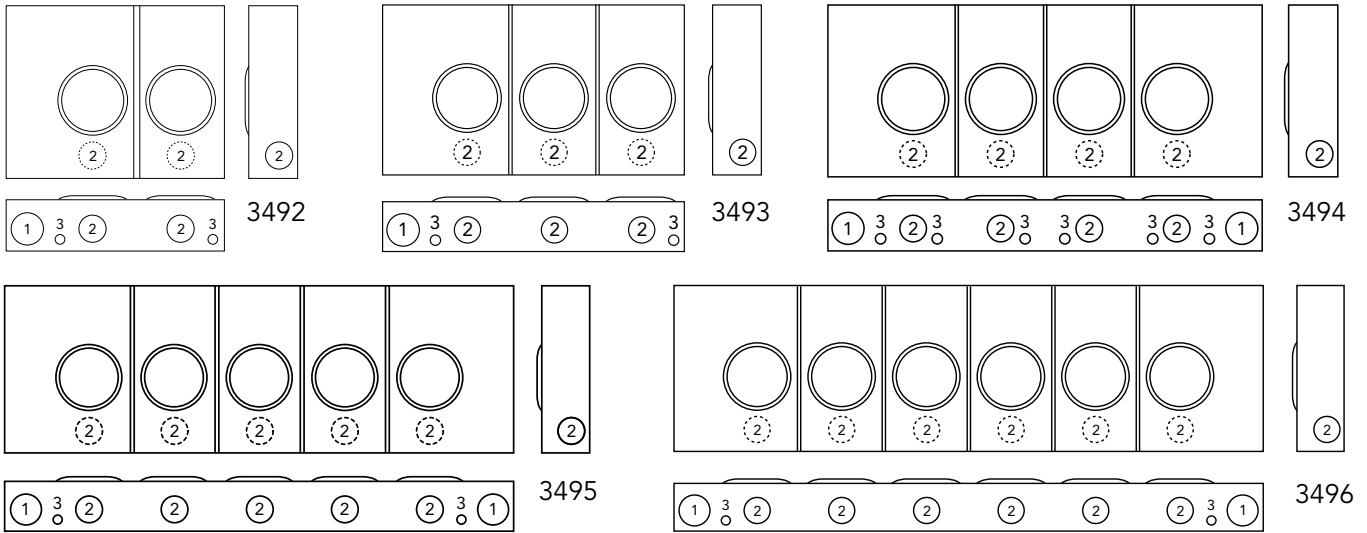

100 Amps per Position | 4 Terminal | Ringless | Multi-Position | 1Ø3W

Catalog Number	Positions	Hub	Connectors CU/AL		Bypass	Dimensions			Knockouts		
			Line	Load		D"	W"	H"	1	2	3
U3492-XL-HSP	2	C.P.	#6-350	#6-2/0	None	4½	20⅞	16	2½	2	¼, ½
U3493-XL-HSP	3	C.P.	#6-350	#6-2/0	None	4½	28½	16	2½	2	¼, ½
U3494-XL-HSP	4	C.P.	#6-350	#6-2/0	None	4½	40⅞	16	2½	2	¼, ½
U3495-XL-HSP	5	C.P.	#6-350	#6-2/0	None	4½	48⅞	16	2½	2	¼, ½
U3496-XL-HSP	6	C.P.	#6-350	#6-2/0	None	4½	57⅞	16	2½	2	¼, ½

## Notes

- **Hubs:** Units are supplied with closing plate at each end. For proper hub selection, see the hub suffix chart on the accessories page.
- **Fifth Terminal Kit:** For field-mounted fifth terminal, order catalog number **5T8K2** in the 6 o'clock position.
- **Connectors:** Extruded aluminum connectors are tin plated. Bonding ground is furnished.
- **Bussing:** Units include ⅝" x 1 aluminum bussing.



Please consult serving utility for their requirements prior to ordering or installing, as specifications and approvals vary by utility, and may require local electrical inspector approval. All installations must be installed by a licensed electrician and must comply with all national and local codes, laws and regulations. Milbank reserves the right to make changes in specifications and features shown without notice or obligation.

# Multi-Position Sockets

150 Amps | 4 Terminal | Ringless | 300 VAC



U1232-X-HSP

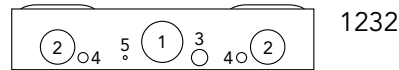
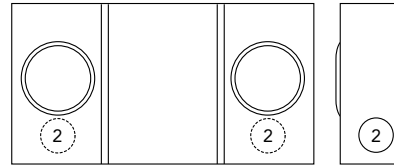

1232

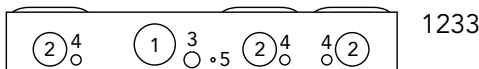
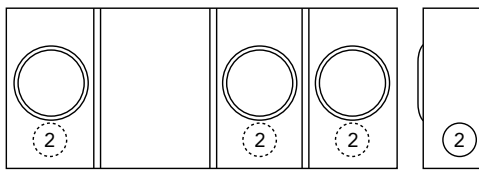

1233

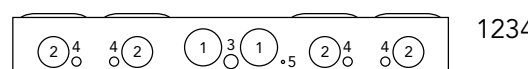
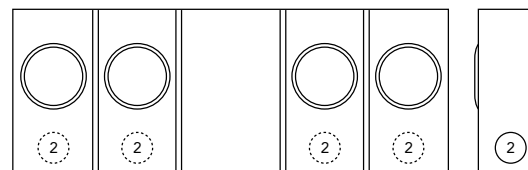

1234

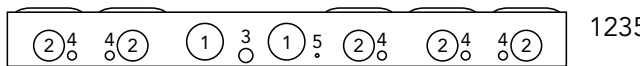
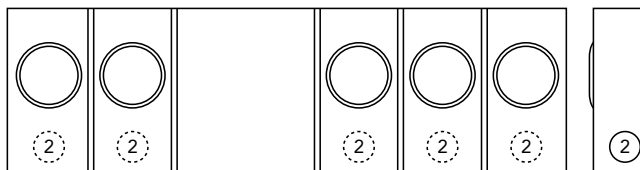

1235

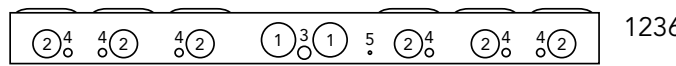
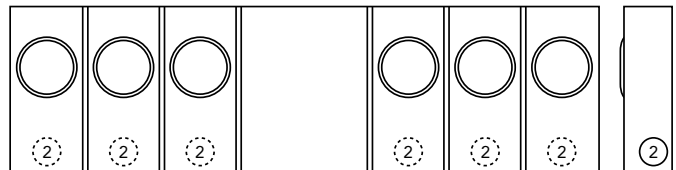

1236

150 Amps per Position | 4 Terminal | Ringless | Multi-Position | 1Ø3W

Catalog Number	Positions	Hub	Connectors CU/AL		Bypass	Dimensions			Knockouts				
			Line	Load		D"	W"	H"	1	2	3	4	5
U1232-X-HSP	2	C.P.	Studs	#6-350	None	5½	26½	14	3	2½	1	½	¼
U1233-X-HSP	3	C.P.	Studs	#6-350	None	5½	34⅙	14	3	2½	1	½	¼
U1234-X-HSP	4	C.P.	Studs	#6-350	None	5½	42⅞	16	3	2½	1	½	¼
U1235-X-HSP	5	C.P.	Studs	#6-350	None	5½	54⅞	16	3	2½	1	½	¼
U1236-X-HSP	6	C.P.	Studs	#6-350	None	5½	63⅙	18	3	2½	1	½	¼

## Notes

- **Hubs:** Units are supplied with closing plates. For proper hub selection, see the hub suffix chart on the accessories page.
- **Fifth Terminal Kit:** For field-mounted fifth terminal, order catalog number **K5T**.
- **Connectors:** Line wire section is supplied with ¾" -16 studs with hex head nuts and captive Belleville washers. Order connector kits separately. One kit per unit. See accessories page.

Please consult serving utility for their requirements prior to ordering or installing, as specifications and approvals vary by utility, and may require local electrical inspector approval. All installations must be installed by a licensed electrician and must comply with all national and local codes, laws and regulations. Milbank reserves the right to make changes in specifications and features shown without notice or obligation.



200 Amps | 4 Terminal | Ringless | 300 VAC



U1252-X-HSP

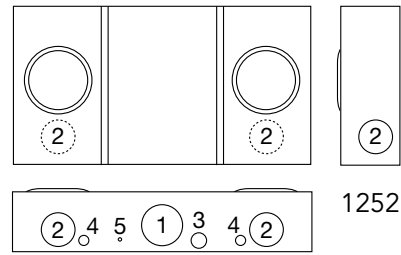

1252

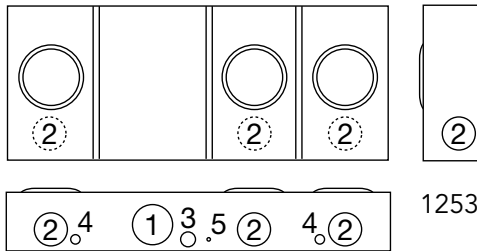

1253

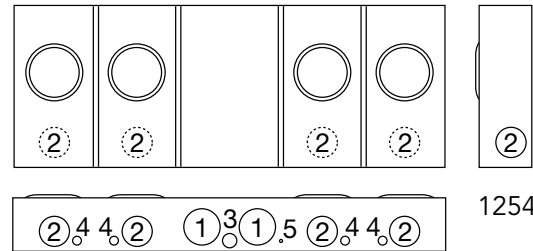

1254

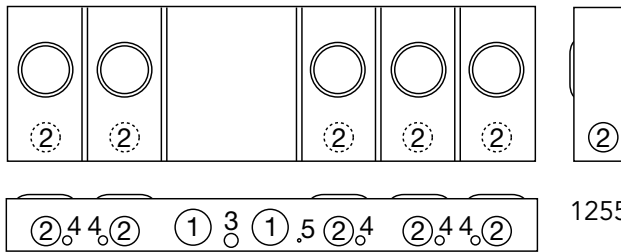

1255

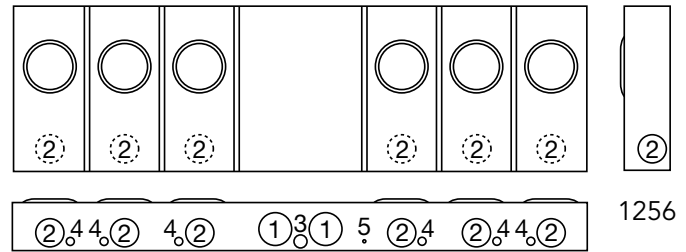

1256

200 Amps per Position | 4 Terminal | Ringless | Multi-Position | 1Ø3W

Steel Catalog Number	Aluminum Catalog Number	Positions	Hub	Connectors CU/AL		Dimensions			Knockouts				
				Line	Load	D"	W"	H"	1	2	3	4	5
U1252-X-HSP	UAP1252-X-HSP	2	C.P.	Studs	#6-350	5 <sup>1</sup> / <sub>8</sub>	26 <sup>1</sup> / <sub>2</sub>	14	3	2 <sup>1</sup> / <sub>2</sub>	1	1 <sup>1</sup> / <sub>2</sub>	1 <sup>1</sup> / <sub>4</sub>
U1253-X-HSP	UAP1253-X-HSP	3	C.P.	Studs	#6-350	5 <sup>1</sup> / <sub>8</sub>	34 <sup>11</sup> / <sub>16</sub>	14	3	2 <sup>1</sup> / <sub>2</sub>	1	1 <sup>1</sup> / <sub>2</sub>	1 <sup>1</sup> / <sub>4</sub>
U1254-X-HSP	UAP1254-X-HSP	4	C.P.	Studs	#6-350	5 <sup>1</sup> / <sub>8</sub>	42 <sup>7</sup> / <sub>8</sub>	16	3	2 <sup>1</sup> / <sub>2</sub>	1	1 <sup>1</sup> / <sub>2</sub>	1 <sup>1</sup> / <sub>4</sub>
U1255-X-HSP	UAP1255-X-HSP	5	C.P.	Studs	#6-350	5 <sup>1</sup> / <sub>8</sub>	54 <sup>7</sup> / <sub>8</sub>	16	3	2 <sup>1</sup> / <sub>2</sub>	1	1 <sup>1</sup> / <sub>2</sub>	1 <sup>1</sup> / <sub>4</sub>
U1256-X-HSP	UAP1256-X-HSP	6	C.P.	Studs	#6-350	5 <sup>1</sup> / <sub>8</sub>	63 <sup>1</sup> / <sub>16</sub>	18	3	2 <sup>1</sup> / <sub>2</sub>	1	1 <sup>1</sup> / <sub>2</sub>	1 <sup>1</sup> / <sub>4</sub>

## Notes

- **Hubs:** Units are supplied with closing plates. For proper hub selection, see the hub suffix chart on the accessories page.
- **Fifth Terminal Kit:** For field-mounted fifth terminal, order catalog number **K5T**.
- **Connectors:** Line wire section is supplied with 3/8"-16 studs with hex head nuts and captive Belleville washers. Order connector kits separately. One kit per unit. See accessories page



Please consult serving utility for their requirements prior to ordering or installing, as specifications and approvals vary by utility, and may require local electrical inspector approval. All installations must be installed by a licensed electrician and must comply with all national and local codes, laws and regulations. Milbank reserves the right to make changes in specifications and features shown without notice or obligation.



# HD Lever Multi-Position Sockets

27

200 Amps | 5 Terminal | Ringless | 600 VAC

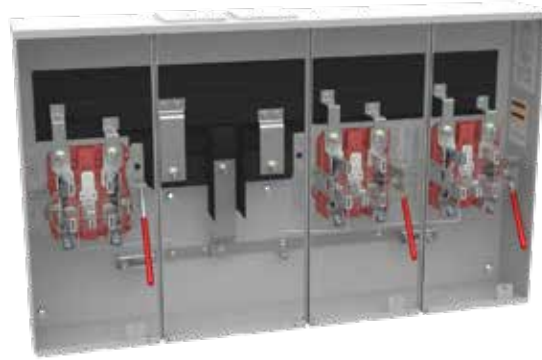

U2873-XT-HSP

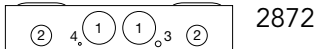
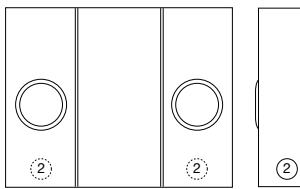

2872

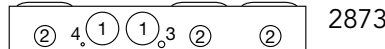
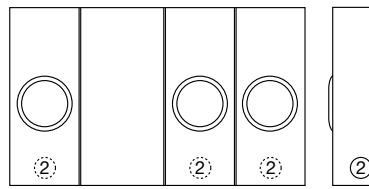

2873

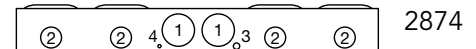
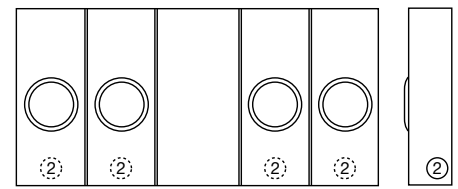

2874

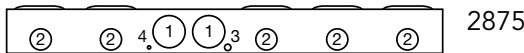
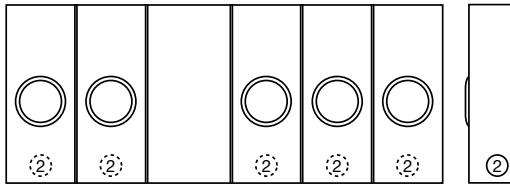

2875

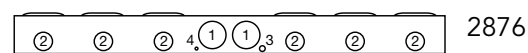
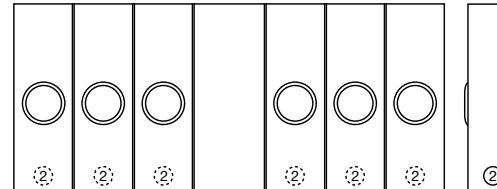

2876

200 Amps per Position | 5 Terminal | Ringless | Multi-Position | 1Ø3W

Catalog Number	Positions	Hub	Connectors CU/AL		Bypass	Dimensions			Knockouts			
			Line	Load		D"	W"	H"	1	2	3	4
U2872-XT-HSP	2	(2) C.P.	3/8" -16 Studs	#6-350	Lever	6	32 3/16	25 1/4	4	2 1/2	1/4, 1/2	1/4
U2873-XT-HSP	3	(2) C.P.	3/8" -16 Studs	#6-350	Lever	6	42 3/16	25 1/4	4	2 1/2	1/4, 1/2	1/4
U2874-XT-HSP	4	(2) C.P.	3/8" -16 Studs	#6-350	Lever	6	52 1/4	25 1/4	4	2 1/2	1/4, 1/2	1/4
U2875-XT-HSP	5	(2) C.P.	3/8" -16 Studs	#6-350	Lever	6	62 5/16	25 1/4	4	2 1/2	1/4, 1/2	1/4
U2876-XT-HSP	6	(2) C.P.	3/8" -16 Studs	#6-350	Lever	6	72 5/16	31 1/4	4	2 1/2	1/4, 1/2	1/4

## Notes

- **Hubs:** Units are supplied with two closing plates. For proper hub selection, see the hub suffix chart on the accessories page.
- **Bypass:** Lever supplies clamping action on meter spades and also operates bypass device.
- **Connectors:** For line side connector kits, order separately. Order one kit per unit. See accessories page.

Please consult serving utility for their requirements prior to ordering or installing, as specifications and approvals vary by utility, and may require local electrical inspector approval. All installations must be installed by a licensed electrician and must comply with all national and local codes, laws and regulations. Milbank reserves the right to make changes in specifications and features shown without notice or obligation.



# HD Lever Multi-Position Sockets

200 Amps | 7 Terminal | Ringless | 600 VAC



U2732-XT-HSP

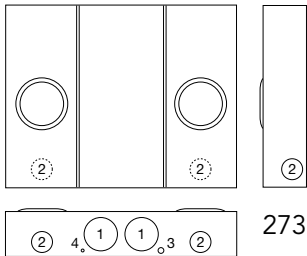

2732

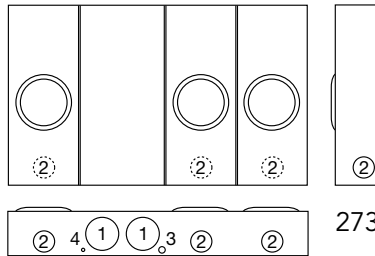

2733

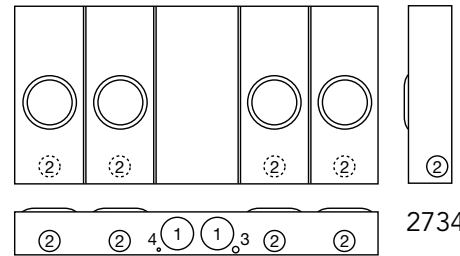

2734

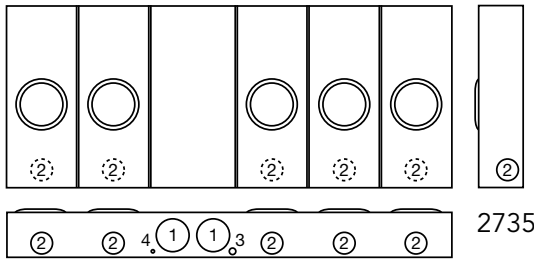

2735

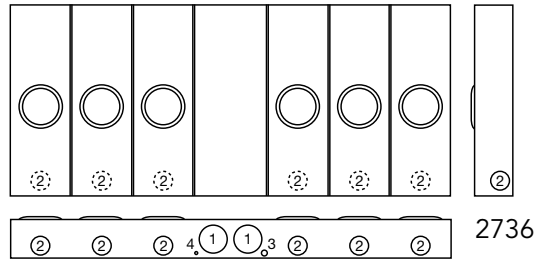

2736

200 Amps per Position | 7 Terminal | Ringless | Multi-Position | 3Ø4W

Catalog Number	Positions	Hub	Connectors CU/AL		Bypass	Dimensions			Knockouts			
			Line	Load		D"	W"	H"	1	2	3	4
U2732-XT-HSP	2	(2) C.P.	3/8" -16 Studs	#6-350	Lever	6	32 3/8	25 1/4	4	2 1/2	1/4, 1/2	1/4
U2733-XT-HSP	3	(2) C.P.	3/8" -16 Studs	#6-350	Lever	6	42 3/16	25 1/4	4	2 1/2	1/4, 1/2	1/4
U2734-XT-HSP	4	(2) C.P.	3/8" -16 Studs	#6-350	Lever	6	52 1/4	25 1/4	4	2 1/2	1/4, 1/2	1/4
U2735-XT-HSP	5	(2) C.P.	3/8" -16 Studs	#6-350	Lever	6	62 3/16	25 1/4	4	2 1/2	1/4, 1/2	1/4
U2736-XT-HSP	6	(2) C.P.	3/8" -16 Studs	#6-350	Lever	6	72 3/8	31 1/4	4	2 1/2	1/4, 1/2	1/4

## Notes

- **Hubs:** Units are supplied with two closing plates. For proper hub selection, see the hub suffix chart on the accessories page.
- **Bypass:** Lever supplies clamping action on meter spades and also operates bypass device.
- **Connectors:** For line side connector kits, order separately. Order one kit per unit. See accessories page.



Please consult serving utility for their requirements prior to ordering or installing, as specifications and approvals vary by utility, and may require local electrical inspector approval. All installations must be installed by a licensed electrician and must comply with all national and local codes, laws and regulations. Milbank reserves the right to make changes in specifications and features shown without notice or obligation.

# Multi-Position Meter Mains

125 & 200 Amps | 4 Terminal | Ringless | 120/240 VAC



U2854-X-HSP



U2866-X-HSP

125 Amps Per Position | 4 Terminal | Multi-Position Sockets | Ringless

Catalog Number	amp	Positions	Service	Hub	Main Bus Rating Amps	Connector Size		Dimensions		
						Line	Load	D"	W"	H"
U2852-X-HSP	125	2	OH/UG	CP	200	3/8" x 16 Stud	CB	5 <sup>13</sup> / <sub>16</sub>	18	25
U2853-X-HSP	125	3	OH/UG	CP	200	3/8" x 16 Stud	CB	5 <sup>13</sup> / <sub>16</sub>	18	37
U2854-X-HSP	125	4	OH/UG	CP	400	3/8" x 16 Stud	CB	4 <sup>7</sup> / <sub>8</sub>	31	25
U2855-X-HSP	125	5	OH/UG	CP	400	3/8" x 16 Stud	CB	4 <sup>7</sup> / <sub>8</sub>	31	37
U2856-X-HSP	125	6	OH/UG	CP	400	3/8" x 16 Stud	CB	4 <sup>7</sup> / <sub>8</sub>	31	37

200 Amps per Position | 4 Terminal | Multi-Position Sockets | Ringless

Catalog Number	amp	Positions	Service	Hub	Main Bus Rating Amps	Connector Size		Dimensions		
						Line	Load	D"	W"	H"
U2862-X-HSP	200	2	OH/UG	CP	250	3/8" x 16 Stud	CB	5 <sup>1</sup> / <sub>8</sub>	26 <sup>1</sup> / <sub>2</sub>	30
U2863-X-HSP	200	3	OH/UG	CP	300	3/8" x 16 Stud	CB	5 <sup>1</sup> / <sub>8</sub>	34 <sup>5</sup> / <sub>8</sub>	30
U2864-X-HSP	200	4	OH/UG	CP	400	3/8" x 16 Stud	CB	5 <sup>1</sup> / <sub>8</sub>	42 <sup>5</sup> / <sub>8</sub>	30
U2865-X-HSP	200	5	OH/UG	CP	600	3/8" x 16 Stud	CB	5 <sup>1</sup> / <sub>8</sub>	51 <sup>1</sup> / <sub>20</sub>	30
U2866-X-HSP	200	6	OH/UG	CP	600	3/8" x 16 Stud	CB	5 <sup>1</sup> / <sub>8</sub>	59 <sup>3</sup> / <sub>10</sub>	30

### Connector Kits

Size	Suffix	Kit Number	Compatible With	Wire Range
Single	-K1	K1539	U2852-56, U2862-66	#6-350
	-K3	K1540	U2854-56, U2864-66	#4-600
Twin	-K2	K1350	U2854-56, U2863-66	#6-350
	-K4	K1541	U2864-66	#2-600

### Breaker Chart

Manufacturer	150-200 Amps	125 or less
Cutler Hammer	BR, WBJ	QP, BR
Siemens	QNR	QP
G.E.	THQ	THQ
Square D.	-	Homeline

### Notes

- **Fifth Terminal:** For field mounted fifth terminal, order catalog number **K2381**. Order one per meter position.
- **Breakers:** Units have provision for one double pole main per meter position. Breakers not included. See breaker chart.
- **Knockouts:** See next page for drawings and knockout configurations.

Please consult serving utility for their requirements prior to ordering or installing, as specifications and approvals vary by utility, and may require local electrical inspector approval. All installations must be installed by a licensed electrician and must comply with all national and local codes, laws and regulations. Milbank reserves the right to make changes in specifications and features shown without notice or obligation.



# Multi-Position Meter Mains

125 & 200 Amps | 4 Terminal | Ringless | 120/240 VAC | 22K AIC



U5882-X-HSP



U5884-X-HSP

Rating kAIC	Circuit Breaker 125A
10	SIEMENS: QP CUTLER-HAMMER: BR, HQP, QHP, QPGF SQUARE D: HOMELINE. G.E.: (50AMP.MAX.) THQL, THQL-GF
22	SIEMENS: QPH
<b>150-200 AMPS</b>	
10	SIEMENS: QN
22	SIEMENS: QNH

### 125 Amps per Position | 4 Terminal | Multi-Position Meter Main | Ringless

Catalog Number	Amps	Positions	Service	Hub	Connectors CU/AL	Bypass	Dimensions			Weight (lbs.)
					Line		D"	W"	H"	
U5902-X-HSP	125	2	OH/UG	C.P.	3/8" x 16 Stud	Horn	5 1/8"	26 1/2"	30"	58
U5903-X-HSP	125	3	OH/UG	C.P.	3/8" x 16 Stud	Horn	5 1/8"	34 5/8"	30"	88
U5904-X-HSP	125	4	OH/UG	C.P.	3/8" x 16 Stud	Horn	5 1/8"	42 5/8"	30"	107
U5905-X-HSP	125	5	OH/UG	C.P.	3/8" x 16 Stud	Horn	5 1/8"	51 1/20"	30"	128
U5906-X-HSP	125	6	OH/UG	C.P.	3/8" x 16 Stud	Horn	5 1/8"	59 3/10"	30"	146

### 200 Amps per Position | 4 Terminal | Multi Position Meter Main | Ringless

Catalog Number	Amps	Positions	Service	Hub	Connectors CU/AL	Bypass	Dimensions			Weight (lbs.)
					Line		D"	W"	H"	
U5882-X-HSP	200	2	OH/UG	C.P.	3/8" x 16 Stud	Horn	5 1/8"	26 1/2"	30"	58
U5883-X-HSP	200	3	OH/UG	C.P.	3/8" x 16 Stud	Horn	5 1/8"	34 5/8"	30"	88
U5884-X-HSP	200	4	OH/UG	C.P.	3/8" x 16 Stud	Horn	5 1/8"	42 5/8"	30"	107
U5885-X-HSP	200	5	OH/UG	C.P.	3/8" x 16 Stud	Horn	5 1/8"	51 1/20"	30"	128
U5886-X-HSP	200	6	OH/UG	C.P.	3/8" x 16 Stud	Horn	5 1/8"	59 3/10"	30"	146

### Notes

- **Knockouts:** See drawings on the next page.
- **Optional:** Factory installed breakers are available - consult factory.
- **AIC Rating:** All models are rated 22K AIC when used with approved breakers rated at 22K.
- **Hub:** Units supplied with one closing plate. Order hubs separately, see accessories page.
- **Fifth Terminal:** For field installed fifth terminal, order **K5T**.
- **Connectors:** Socket is supplied with 3/8" - 16 hex head nuts with Belleville washers. For connector lug kits, order as extra from chart on the accessories page. Separate lug kits are required for line and load.



Please consult serving utility for their requirements prior to ordering or installing, as specifications and approvals vary by utility, and may require local electrical inspector approval. All installations must be installed by a licensed electrician and must comply with all national and local codes, laws and regulations. Milbank reserves the right to make changes in specifications and features shown without notice or obligation.

# Multi-Position Meter Mains

## Dimensional Information

Knockouts				
1	2	3	4	5
3	2½	1	¾	¼

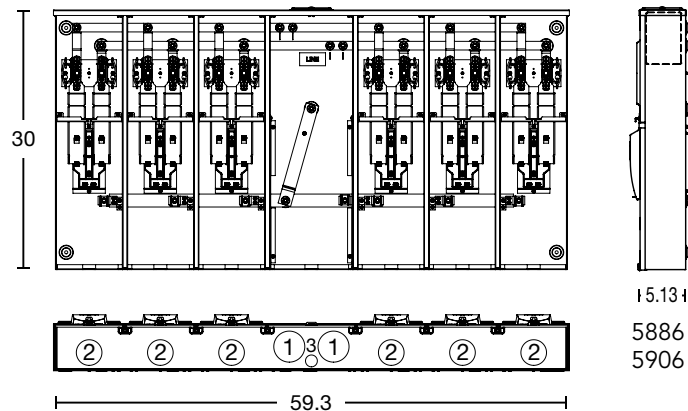
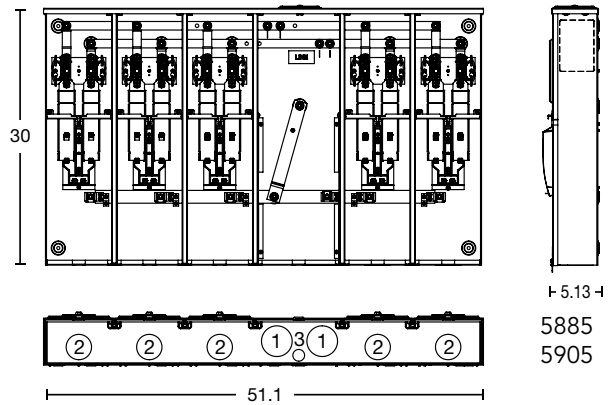
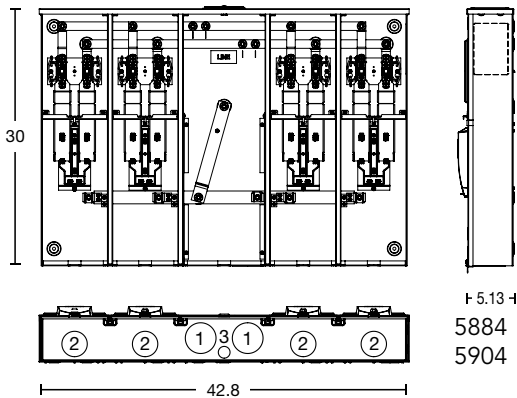
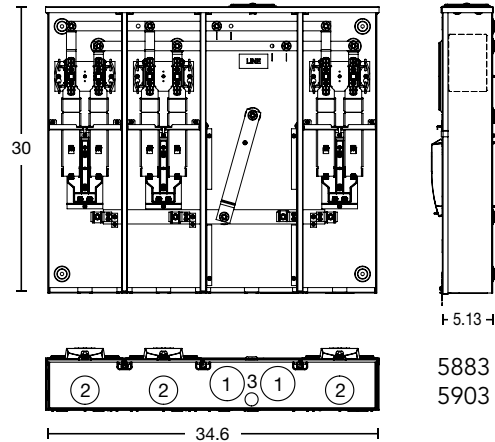
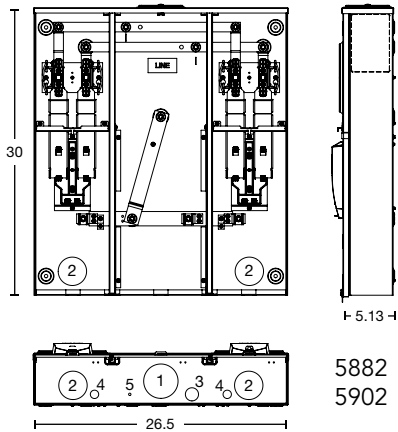

Please consult serving utility for their requirements prior to ordering or installing, as specifications and approvals vary by utility, and may require local electrical inspector approval. All installations must be installed by a licensed electrician and must comply with all national and local codes, laws and regulations. Milbank reserves the right to make changes in specifications and features shown without notice or obligation.

**MEG**  
APPROVED



# Multi-Position Meter Mains

125 & 200 Amps | 4 Terminal | Ringless | 120/240 VAC | 22K AIC



U5882-X-KK-BLG



U5884-X-KK-BLG

Rating kAIC	Circuit Breaker 125A
10	SIEMENS: QP CUTLER-HAMMER: BR, HQP, QHP, QPGF SQUARE D: HOMELINE. G.E.: (50AMP.MAX.) THQL, THQL-GF
22	SIEMENS: QPH
<b>150-200 AMPS</b>	
10	SIEMENS: QN
22	SIEMENS: QNH

### 125 Amps per Position | 4 Terminal | Multi-Position Meter Main | Ringless

Catalog Number	Amps	Positions	Service	Hub	Connectors CU/AL	Bypass	Dimensions			Weight (lbs.)
					Line		D"	W"	H"	
U5902-X-KK-BLG	125	2	OH/UG	C.P.	3/8" x 16 Stud	Horn	5 1/8"	26 1/2"	30"	58
U5903-X-KK-BLG	125	3	OH/UG	C.P.	3/8" x 16 Stud	Horn	5 1/8"	34 5/8"	30"	88
U5904-X-KK-BLG	125	4	OH/UG	C.P.	3/8" x 16 Stud	Horn	5 1/8"	42 5/8"	30"	107
U5905-X-KK-BLG	125	5	OH/UG	C.P.	3/8" x 16 Stud	Horn	5 1/8"	51 1/20"	30"	128
U5906-X-KK-BLG	125	6	OH/UG	C.P.	3/8" x 16 Stud	Horn	5 1/8"	59 3/10"	30"	146

### 200 Amps per Position | 4 Terminal | Multi Position Meter Main | Ringless

Catalog Number	Amps	Positions	Service	Hub	Connectors CU/AL	Bypass	Dimensions			Weight (lbs.)
					Line		D"	W"	H"	
U5882-X-KK-BLG	200	2	OH/UG	C.P.	3/8" x 16 Stud	Horn	5 1/8"	26 1/2"	30"	58
U5883-X-KK-BLG	200	3	OH/UG	C.P.	3/8" x 16 Stud	Horn	5 1/8"	34 5/8"	30"	88
U5884-X-KK-BLG	200	4	OH/UG	C.P.	3/8" x 16 Stud	Horn	5 1/8"	42 5/8"	30"	107
U5885-X-KK-BLG	200	5	OH/UG	C.P.	3/8" x 16 Stud	Horn	5 1/8"	51 1/20"	30"	128
U5886-X-KK-BLG	200	6	OH/UG	C.P.	3/8" x 16 Stud	Horn	5 1/8"	59 3/10"	30"	146

### Notes

- **Knockouts:** See drawings on the next page.
- **AIC Rating:** All models are rated 22K AIC when used with approved breakers rated at 22K.
- **Hub:** Units supplied with one (1) closing plate. Order hubs separately, see accessory page.
- **Fifth Terminal:** For field installed fifth terminal, order **K5T**.
- **Connectors:** Socket is supplied with 3/8" - 16 hex head nuts with Belleville washers. For connector lug kits, order as extra from chart on the accessories page. Separate lug kits are required for line and load.



Please consult serving utility for their requirements prior to ordering or installing, as specifications and approvals vary by utility, and may require local electrical inspector approval. All installations must be installed by a licensed electrician and must comply with all national and local codes, laws and regulations. Milbank reserves the right to make changes in specifications and features shown without notice or obligation.

# Temporary Power Outlet

33

125 Amps | 4 Terminal | Ringless

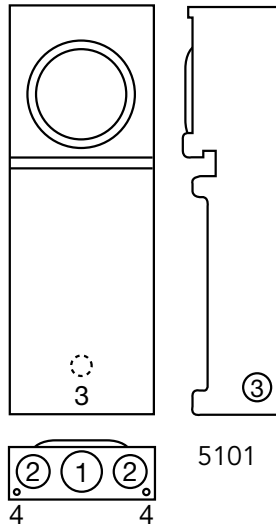

U5101-XL-11GR-HSP

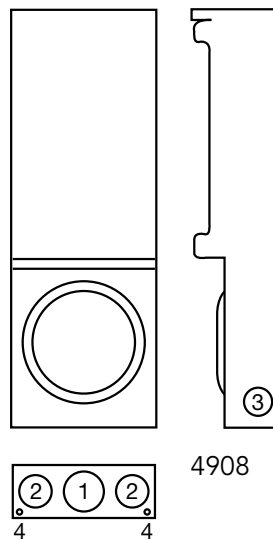

U4908-O-11GR

## 125 Amps | 4 Terminal | Metered Temporary Power Outlet | Ringless

Catalog Number	amp	Service	Hub	Connector Size	Dimensions			Knockouts			
					D"	W"	H"	1	2	3	4
U5101-XL-11GR-HSP	125	OH	CP	#6-250 kcmil	5 $\frac{3}{16}$	8 $\frac{7}{8}$	25	2	1 $\frac{1}{4}$	1 $\frac{1}{4}$	$\frac{1}{4}$
U4908-O-11GR-HSP	125	UG	Blank	#6-2/0	5 $\frac{3}{16}$	8 $\frac{7}{8}$	25	1 $\frac{1}{2}$	1 $\frac{1}{2}$	1 $\frac{1}{4}$	$\frac{1}{4}$

### Notes

- **Interior:** Six-circuit plated copper interior accepts standard plug-in type circuit breakers.
- **Receptacle Bridge:** Three position self-grounded receptacle bridge accepts most standard NEMA receptacles with mounting plates.
- **Included Parts:** U4908 and U5101 come supplied with two 20 Amps 1-pole breakers and two 20 Amps GFCI receptacles (prewired and installed).

Please consult serving utility for their requirements prior to ordering or installing, as specifications and approvals vary by utility, and may require local electrical inspector approval. All installations must be installed by a licensed electrician and must comply with all national and local codes, laws and regulations. Milbank reserves the right to make changes in specifications and features shown without notice or obligation.





# 3 4 Meter Main with Load Center Pedestal

100–200 Amps | 4 Terminal | Ringless | 120/240 VAC



U5136-O-200S-FMG

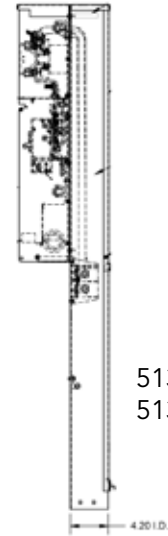
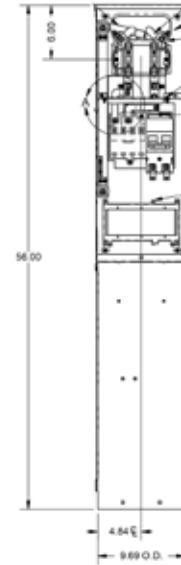
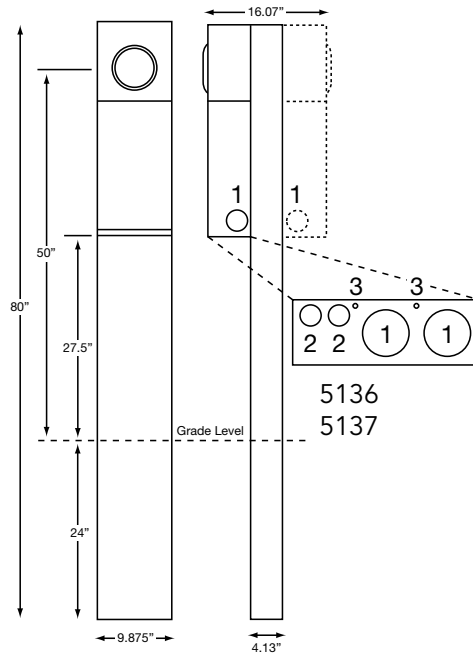

5138  
5139

## Specifications

- UL listed File **E90945**
- **K5415** stabilizer foot included with pedestal for field installation
- 200 Amps maximum, 120/240 V, 1Ø3W
- Ringless type meter socket with stainless steel latch
- Pedestals with factory installed breakers are 22KAIC
- Type 3R construction for durable outdoor use
- ANSI 61 grey polyester powder coat finish
- Wire terminations accept copper or aluminum conductors
- Line & Neutral: (2) #6-350 kcmil per phase, Line Ground: (4) #14-1/0
- Load (CB): 2/0 to 300 kcmil per pole for 200 Amps breaker.
- Load neutral: (1) #6-350 kcmil
- Load ground: (2) #14-1/0, (4) #14 – 6
- Commercial grade, plug-in main circuit breaker. Available in 100, 125, 150 & 200 Amps. Type **UQFPH-M**.
- 4 circuit plated copper interior accepts (2) 2-pole or (4) 1-pole standard plug-in type circuit breakers. Four branch circuits rated 125 Amps max. Acceptable manufacturers: Cutler-Hammer, GE, Siemens or Square D Homeline
- **Pad Mount Units:** Pad mount pedestals are available. Order **U5138** (single meter) or **U5139** (double meter) prefix. **K5035** pad mount kit required. Order separately.

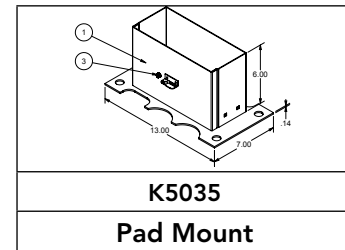

**K5035**

**Pad Mount**



Please consult serving utility for their requirements prior to ordering or installing, as specifications and approvals vary by utility, and may require local electrical inspector approval. All installations must be installed by a licensed electrician and must comply with all national and local codes, laws and regulations. Milbank reserves the right to make changes in specifications and features shown without notice or obligation.

# Meter Main with Load Center Pedestal

# 35

100–200 Amps | 4 Terminal | Ringless | 120/240 VAC

## 100–200 Amps | Meter Main with Load Center Pedestal | Ringless

Catalog Number	Powerheads	Amps	Main Breaker	Interior	Dimensions			Knockouts		
					D"	W"	H"	1	2	3
U5136-O-100S-FMG	Single	100	UQFP-M-100 (Series)	4 circuit	10¼	10	80	2	½,¾	¼
U5136-O-125S-FMG	Single	125	UQFP-M-125 (Series)	4 circuit	10¼	10	80	2	½,¾	¼
U5136-O-150S-FMG	Single	150	UQFP-M-150 (Series)	4 circuit	10¼	10	80	2	½,¾	¼
U5136-O-200S-FMG	Single	200	UQFP-M-200 (Series)	4 circuit	10¼	10	80	2	½,¾	¼
U5136-O-100P-FMG	Single	100	UQFP-M-100 (Parallel)	4 circuit	10¼	10	80	2	½,¾	¼
U5136-O-125P-FMG	Single	125	UQFP-M-100 (Parallel)	4 circuit	10¼	10	80	2	½,¾	¼
U5136-O-150P-FMG	Single	150	UQFP-M-100 (Parallel)	4 circuit	10¼	10	80	2	½,¾	¼
U5136-O-200P-FMG	Single	200	UQFP-M-100 (Parallel)	4 circuit	10¼	10	80	2	½,¾	¼
U5136-O-FMG	Single	—	Breaker provision	4 circuit	10¼	10	80	2	½,¾	¼
U5137-O-100S-FMG	Double	100	(2) UQFP-M-100 (Series)	4 circuit	16¼	10	80	2	½,¾	¼
U5137-O-125S-FMG	Double	125	(2) UQFP-M-125 (Series)	4 circuit	16¼	10	80	2	½,¾	¼
U5137-O-150S-FMG	Double	150	(2) UQFP-M-150 (Series)	4 circuit	16¼	10	80	2	½,¾	¼
U5137-O-200S-FMG	Double	200	(2) UQFP-M-200 (Series)	4 circuit	16¼	10	80	2	½,¾	¼
U5137-O-100P-FMG	Double	100	(2) UQFP-M-100 (Parallel)	4 circuit	16¼	10	80	2	½,¾	¼
U5137-O-125P-FMG	Double	125	(2) UQFP-M-100 (Parallel)	4 circuit	16¼	10	80	2	½,¾	¼
U5137-O-150P-FMG	Double	150	(2) UQFP-M-100 (Parallel)	4 circuit	16¼	10	80	2	½,¾	¼
U5137-O-200P-FMG	Double	200	(2) UQFP-M-100 (Parallel)	4 circuit	16¼	10	80	2	½,¾	¼
U5137-O-FMG	Double	—	Breaker provision	4 circuit	16¼	10	80	2	½,¾	¼

## Notes

- **Parallel to Series Conversion:** For field converting from parallel wired to series wired order **K5194**.
- **Fifth Terminal:** For field installed fifth terminal, order **K5T**.
- **Receptacles:** Consult factory for installed receptacle assemblies.

Please consult serving utility for their requirements prior to ordering or installing, as specifications and approvals vary by utility, and may require local electrical inspector approval. All installations must be installed by a licensed electrician and must comply with all national and local codes, laws and regulations. Milbank reserves the right to make changes in specifications and features shown without notice or obligation.



# 36 Meter Main with Load Center Pedestal

100 & 200 Amps | 4 Terminal | Ringless | 120/240 VAC

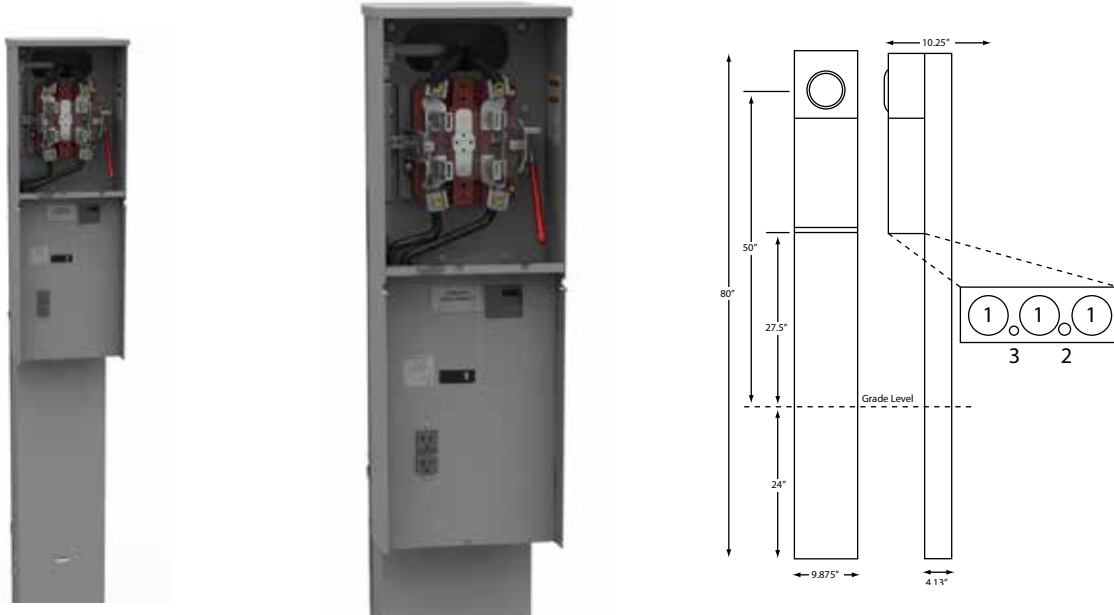

U6396-O-200-10GR-HSP

100 & 200 Amps | Meter Main with Load Center Pedestal | Ringless

Catalog Number	Amp	Service	Connectors CU/AL		Interior	Dimensions			Knockouts		
			Line	Load		D"	W"	H"	1	2	3
U6396-O-100-10GR-HSP	100	UG	(2) #6-350 kcmil	(1) #6-350 kcmil	8 circuit	10 $\frac{1}{4}$	10	80	2	$\frac{1}{2}$	$\frac{1}{4}$
U6396-O-200-10GR-HSP	200	UG	(2) #6-350 kcmil	(1) #6-350 kcmil	8 circuit	10 $\frac{1}{4}$	10	80	2	$\frac{1}{2}$	$\frac{1}{4}$

## Specifications & Features

- UL listed
- 200 Amps maximum, 120/240 volt, single phase, three wire meter socket
- Short circuit withstand rating of 22K AIC
- Type 3R construction for durable outdoor use, one piece post — lockable and sealable
- Direct bury pedestal
- Circuit breaker: available with 100 or 200 Amps main breaker
- 8-circuit load center with feed through lugs
- Acceptable branch breaker manufacturers: Cutler-Hammer, GE, Siemens, or Square D Homeline
- Milbank grey polyester powder coat finish
- Wire terminations accept copper or aluminum conductors
- Line & neutral: (2) #6-350 kcmil per phase
- Line ground: (4) #14-1/0
- Load neutral: (1) #6-350 kcmil
- Load ground: (2) #14-1/0, (4) #14/6
- 20 Amps GFCI receptacle and 20 Amps breaker factory installed. 2 receptacles factory installed option available
- Stainless steel hasps
- Receptacles: Consult factory for installation of (2) 20 Amps GFCI receptacle assemblies.
- Field installed 5th terminal kits





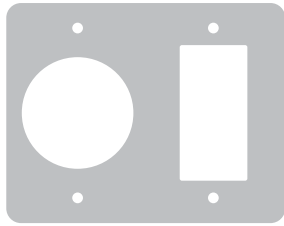
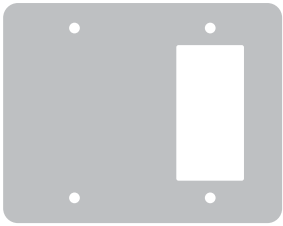
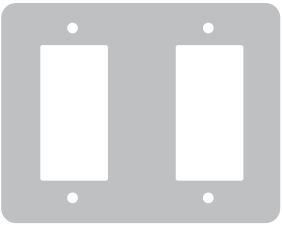

Please consult serving utility for their requirements prior to ordering or installing, as specifications and approvals vary by utility, and may require local electrical inspector approval. All installations must be installed by a licensed electrician and must comply with all national and local codes, laws and regulations. Milbank reserves the right to make changes in specifications and features shown without notice or obligation.

# Replacement Parts & Accessories

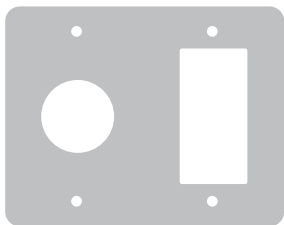
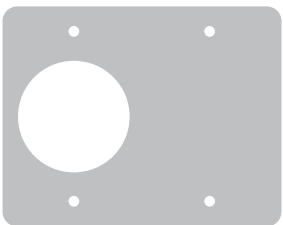
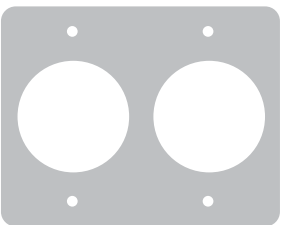
For U5136–U5139 Pedestals

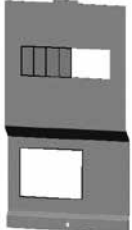

		
<b>K5935-41</b>	<b>K5935-10GR</b>	<b>K5935-11GR</b>



		
<b>K5935-36GR</b>	<b>K5935-54</b>	<b>K5935-2/1450</b>

		
<b>Z1115081</b> Lug landing base	<b>Z819294-SC</b> With receptacle openings <b>Z1139163</b> Without receptacle openings	<b>Z1102270</b> Hinged cover

Please consult serving utility for their requirements prior to ordering or installing, as specifications and approvals vary by utility, and may require local electrical inspector approval. All installations must be installed by a licensed electrician and must comply with all national and local codes, laws and regulations. Milbank reserves the right to make changes in specifications and features shown without notice or obligation.



		
<p><b>Q120</b> 20 Amps, 1 pole circuit breaker</p>	<p><b>Q130</b> 30 Amps, 1 pole circuit breaker</p>	<p><b>Q250</b> 50 Amps, 2 pole circuit breaker</p>

		
<p><b>Z708080-MO</b> 20 Amps GFI receptacle NEMA 5-20GR</p>	<p><b>Z701776-MO</b> 30 Amps receptacle NEMA TT-30</p>	<p><b>Z708767-MO</b> 50 Amps receptacle NEMA 14-50R</p>



Please consult serving utility for their requirements prior to ordering or installing, as specifications and approvals vary by utility, and may require local electrical inspector approval. All installations must be installed by a licensed electrician and must comply with all national and local codes, laws and regulations. Milbank reserves the right to make changes in specifications and features shown without notice or obligation.

# Accessories

## Hubs and Closing Plates

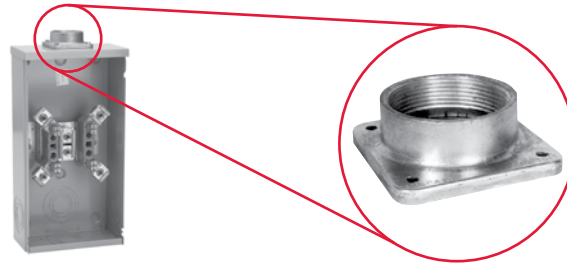
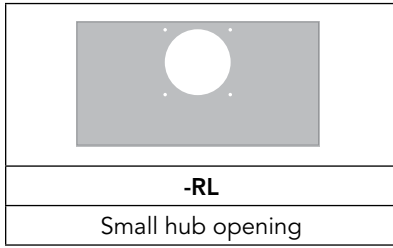

<b>-WL</b>   <b>A7514</b>	<b>-YL</b>   <b>A7515</b>	<b>-ZL</b>   <b>A7516</b>	<b>-DL</b>   <b>A7517</b>	<b>-EL</b>   <b>A7518</b>	<b>-XL</b>   <b>A7551</b>
1" hub	1¼" hub	1½" hub	2" hub	2½" hub	Small closing plate

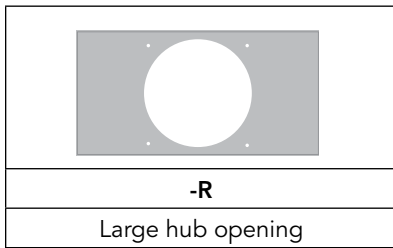

<b>-F</b>   <b>A8110</b>	<b>-G</b>   <b>A8111</b>	<b>-H</b>   <b>A8112</b>	<b>-X</b>   <b>A9064</b>	<b>-RRL</b>   <b>S8324</b>
3" hub	3½" hub	4" hub	Large closing plate	Large hub opening adapted to small hub opening

### Notes

- **Suffix:** Add to catalog number for factory installation of hub.
- **Packaging:** Individually packed units for field installation.
- **Abbreviations:** H.O. (hub opening), C.P. (closing plate).

Please consult serving utility for their requirements prior to ordering or installing, as specifications and approvals vary by utility, and may require local electrical inspector approval. All installations must be installed by a licensed electrician and must comply with all national and local codes, laws and regulations. Milbank reserves the right to make changes in specifications and features shown without notice or obligation.



## Connector Kits, Closing Kits & Generator Interlock

### Connector Kits — For Use with 3/8"-16 Stud Type Units Only

Single			Twin		
Suffix	Part #	(3 per set) - 1Ø	Suffix	Part #	(3 per set) - 1Ø
K1	K1539	6-350	K2	K1350	6-350
K3	K1540	4-600 or (2) 1/0-250*	K2L	K1350L	6-350 (non rotating)
K3L	K1540L	4-600 or (2) 1/0-250* (non rotating)	K4	K1541	4-600
Suffix	Part #	(4 per set) - 3Ø	Suffix	Part #	(4 per set) - 3Ø
K5	K3082	6-350	K6	K3442	6-350
K7	K3441	4-600 or (2) 1/0-250*	K8	K3083	4-600

\*For (2) 1/0-250, conductors must be of same size.

### Bypass Link



**K8180** (sold in pairs)

### Note

Consult factory for proper connector kits for studded meter sockets.

### Closing Covers

Meter Closing Plate (Ring Type / Ringless)	Metal Closing Plate (For Ringless Sockets)
6003 - Grey Plastic	CP-21
6116 - Clear Plastic	

### Generator Interlock

K5815 - large QN with small frame Q
K5820 - large frame QN with large frame QN
K5830 - small frame Q to small frame Q

### Disconnect Sleeve

M5-144
Do not use with lever bypass sockets

### Anti-Inversion Clip

K4802



### Isolated Neutral Kit

K1047
Consult factory for proper isolated neutral for meter sockets



## Fifth Terminal, Tap Connectors & Block Assemblies

### Fifth Terminal

		
<b>5T8K2</b> - 100-200 Amps "Plug-In"	<b>K5T</b> - 200 Amps (Block with Square Hole)	<b>K3865</b> - Heavy Duty Jaw Clamping ( <b>K3866</b> without Neutral Wire)

### Tap Connectors (3 per set)

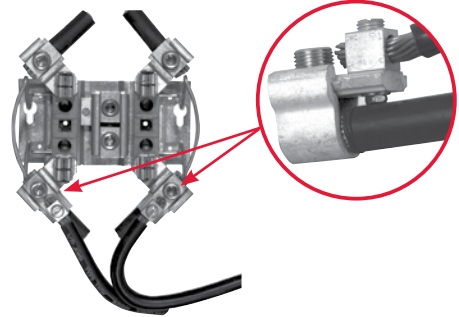
	Replaces the load or line side slide-in nut assembly on Milbank 200 Amps sockets. Allows for a 100 Amps tap location in addition to the #6-350 kcmil load-side connector. <b>K5022</b> includes safety barrier extensions for applications over 300 VAC. Three lugs per kit.
<b>K4977-INT</b> - Internal Hex	
<b>K4977-EXT</b> - External Hex	
<b>K5022-INT</b> - Internal Hex (set of 4 w/ barrier)	

### Triplex Ground

<b>K1190</b> (For factory installed triplex ground, add suffix -TG to catalog number)

### 100 Amps Blocks *(single sockets only)*

<b>BL7474</b> - Block Assembly
<b>BL7499</b> - Horn Bypass Block Assembly
<b>Z904486-AO</b> - Slotted Nut Assembly
<b>Z903274-AO</b> - Horn Bypass Nut Assembly
<b>Z802965-AC</b> - Neutral without Nut
<b>Z901925-AC</b> - Hex Nut Set Screw

### 200 Amps Blocks *(single sockets only)*

<b>K4527</b> - Internal Hex Block Assembly (w/ meter support)
<b>K4528</b> - External Hex Block Assembly (w/ meter support)
<b>K4529</b> - Internal Hex Horn Bypass Block Assembly (w/ meter support)
<b>K4530</b> - External Hex Horn Bypass Block Assembly (w/ meter support)
<b>Z916265-AO</b> - Internal Nut Assembly
<b>Z916264-AO</b> - External Nut Assembly
<b>Z814898-AC</b> - Neutral without Nut

Please consult serving utility for their requirements prior to ordering or installing, as specifications and approvals vary by utility, and may require local electrical inspector approval. All installations must be installed by a licensed electrician and must comply with all national and local codes, laws and regulations. Milbank reserves the right to make changes in specifications and features shown without notice or obligation.



*Attractive | Easy to Install | Secure | Cost-Effective*

**Milbank Enclosed Controls** are pad-mounted, weather resistant electrical enclosures consisting of a utility pull section with optional meter socket, and a customer section containing distribution and control equipment. Commercial pedestals are an attractive, secure, easy to install and cost-effective solution when underground remote site power distribution and control equipment is required, replacing unsightly and inefficient strut and backboard structures.



**Strut and backboard**



**Commercial pedestal**

## UL Listed as Industrial Control Equipment (File E113855)

### Standard Features

- Type 3R rain-resistant, vandal-resistant cabinet of polyurethane powder coated steel (aluminum or stainless steel also available)
- UL listed as enclosed industrial control equipment (UL508A)
- Isolated lockable and sealable utility metering and lug landing sections
- Lockable customer section for distribution and control equipment with internal deadfront
- Print pocket inside customer section door contains wiring schematics and installation instructions
- Load centers are UL listed for use with various manufacturers' circuit breakers
- All stainless steel external hardware (screws, bolts, hinges, handles, hasps and sealing screws)



Please consult serving utility for their requirements prior to ordering or installing, as specifications and approvals vary by utility, and may require local electrical inspector approval. All installations must be installed by a licensed electrician and must comply with all national and local codes, laws and regulations. Milbank reserves the right to make changes in specifications and features shown without notice or obligation.

# Enclosed Controls

Attractive | Easy to Install | Secure | Cost-Effective



## Applications

These units are ideal for controlling and metering:

- Traffic signals
- Street lighting
- Power distribution for electronic vehicle charging stations
- Communication equipment such as cell towers and telephone vaults
- Event power for fairs, swap meets, outdoor markets, portable offices, holiday lights, etc.
- Outdoor lighting for athletic fields, tennis and basketball courts, parking lots, landscaping and subdivision entrances, etc.

## Available Factory-Installed Options

- Meter sockets: ring type or ringless, up to 400 Amps
- Main and branch breakers or T fuses
- Distribution: copper load centers and panel boards
- Clocks, timers and relays
- Photoelectric cells and controls
- Various power receptacles: pin and sleeve, twist lock or straight blade
- Contactors: lighting, definite purpose, motor starters
- Surge protection and lightning arrestors
- Generator inlets with interlocked breakers
- Push button controls
- Thermostat controls, fans and heating strips
- Power blocks and terminal blocks
- Steel, aluminum and plywood backboards
- Transformers
- Interlock devices for circuit breakers

## Options

- Available in steel, aluminum (raw painted or anodized) or stainless steel construction with powder coated finish available in eight standard colors or special-ordered RAL colors
- Available for applications up to 400 Amps, 120V, 208V, 240V, 277V, 480V - 1Ø or 3Ø

## Accessories

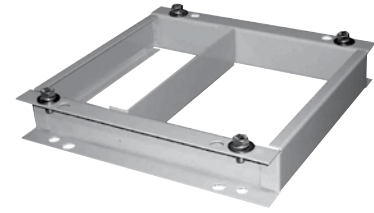

Padmount bases available for all pedestal sizes, inquire with your representative for details

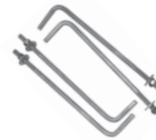

### CP-ABK5/8

Anchor bolt kit (includes four 5/8 - 13 x 18" anchor bolts)



### 105J

Fifth terminal kit for use with ring type meter sockets



### K3865

Fifth terminal kit for use with ringless meter sockets



### CP-TC7D

7-day time clock kit

### CP-TC24H

24-hour time clock kit

### CP-TCWIRE

Male 4-pin connector and wiring harness for use with time clocks other than above



### CP-PE-HOA-3POS

HOA switch for field installation

Please consult serving utility for their requirements prior to ordering or installing, as specifications and approvals vary by utility, and may require local electrical inspector approval. All installations must be installed by a licensed electrician and must comply with all national and local codes, laws and regulations. Milbank reserves the right to make changes in specifications and features shown without notice or obligation.



## Main Load Center Commercial Pedestal

1Ø3 wire 120/240V or 208Y/120V

*Application: remote site service for multiple loads*

**Milbank Main Load Center Commercial Pedestals** are designed to handle the vast majority of all requirements in a standard, stocked configuration.

- All units feature a load center with a plug-on, back-fed main breaker.
- Standard units are equipped with with a 16 circuit load center in the 100 Amps or 24 circuit load center in 200A models
- Sub-feed lugs to allow feeding an external panel.

If your application requires turning loads on based on “dusk-to-dawn” requirements, be sure to see the Milbank Switched Load Center Commercial Pedestal products on the following page.

### Features

These units include everything required for remote site service:

- Expandable: load centers allow for future expansion without costly modifications.
- All units feature a 200 Amps meter socket with optional field-installable fifth terminal kit available.
- 22K Amps interrupting capacity (AIC) standard.
- Optional mounting base can be embedded in concrete for fast, easy installation.
- Separate sealable and lockable utility termination section.
- Separate sealable and lockable metering section.
- Separate sealable and lockable customer section with a load center for “always on” loads that include a main circuit breaker, 20 (125 or 200 Amps model) or 14 (100 Amps model) blank breaker spaces and a circuit directory to document configuration.



Please consult serving utility for their requirements prior to ordering or installing, as specifications and approvals vary by utility, and may require local electrical inspector approval. All installations must be installed by a licensed electrician and must comply with all national and local codes, laws and regulations. Milbank reserves the right to make changes in specifications and features shown without notice or obligation.

### Switched Load Center Commercial Pedestals

1Ø3 wire 120/240V or 208Y/120V

Designed not only to provide power for various loads, but also to switch specific loads on and off under certain conditions. A photoelectric cell is used for these controlled loads, and an optional time clock is also available.

#### Features

These units include everything required for remote site service:

- Expandable: load centers allow for future expansion without costly modifications.
- All units feature a 200 Amps meter socket with optional field-installable fifth terminal kit available.
- 22K Amps interrupting capacity (AIC) standard.
- Optional mounting base can be embedded in concrete for fast, easy installation.
- Separate sealable and lockable utility termination section.
- Separate sealable and lockable metering section.
- Separate sealable and lockable customer section with a control circuit including PE receptacle, Lexan® window, glare shield, Hand-Off-Auto (HOA) switch, contractor controlling a 16-circuit load center for controlled loads, a pre-mounted DIN rail and pre-wired connector to add an optional "plug-and-play" time clock kit for PE on and TC off operation and a circuit directory to document configuration.
- A load center for "always on" loads that includes a main circuit breaker, a control power circuit breaker, a switched load center main breaker, nine (125 or 200 Amps model) or 11 (100 Amps model) blank breaker spaces and a circuit directory to document configuration.



#### Applications



Traffic Signals

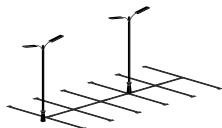

Parking Lots



Highways

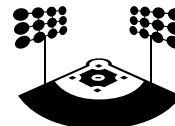

Athletic Field Lighting

Please consult serving utility for their requirements prior to ordering or installing, as specifications and approvals vary by utility, and may require local electrical inspector approval. All installations must be installed by a licensed electrician and must comply with all national and local codes, laws and regulations. Milbank reserves the right to make changes in specifications and features shown without notice or obligation.







Designed to provide a weather and vandal resistant metered enclosure for various loads and distribution. Each pedestal has been designed to handle a wide range of applications using standard, stocked configurations.

- Choice of a single main breaker or twin service disconnect breakers gives flexibility to the pedestal design.
- Optional distribution with feed-through lugs below the service disconnect breakers allows the pedestal to handle numerous applications.
- Typical applications include remote homes where the metering is best located at the curb side or other remote area. The pedestal can also provide power to secondary residence, on-site business, workshop, irrigation, lighting, security or other secondary load.
- Available in custom colors to match home or landscaping.

### Features

These units include everything required for remote service:

- Main circuit breaker or dual service disconnects
- Expandable: load center units allow for future expansion without costly modifications
- Optional mounting base can be embedded in concrete for fast, easy installation
- Separate sealable and lockable utility termination section with lug termination
- Separate sealable and lockable metering section
- A separate sealable and lockable customer section with a circuit directory and a print pocket to hold all documentation
- Meter socket options include ring type with bypass studs, ringless with heavy duty lever bypass, or K-Type bolt-on

### Applications

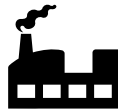

Commercial Job sites



Remote site for  
Residential &  
Commercial job Sites



Please consult serving utility for their requirements prior to ordering or installing, as specifications and approvals vary by utility, and may require local electrical inspector approval. All installations must be installed by a licensed electrician and must comply with all national and local codes, laws and regulations. Milbank reserves the right to make changes in specifications and features shown without notice or obligation.

# Enclosed Controls

## Surface-Mount Compact Design

### Surface-Mount Commercial Pedestal

Originally developed for small cellular communications, the surface-mount enclosed control offers the flexibility of larger enclosed controls products with a smaller footprint and several mounting options.

#### Features

- Easy installation
- Overhead and underground entry and exit, all in one unit
- Meter and components in one enclosure
- UL508A & UL891
  - Custom component configurations
  - UL listing covers all internal components
- Can be mounted on multiple surfaces
  - Walls
  - Poles – narrow profile will have minimal extension past sides
  - H Frames (Strut)
- Multiple bypass options available
- Monitoring options available
- Can be powder coated in any Milbank standard EC colors or custom colors.



#### Benefits

- Does not take up sidewalk space
- Flood resistant
- Eliminates need for connecting components - Wire in - Wire Out

#### Applications



Communications  
Power  
Distribution



Lighting  
Control

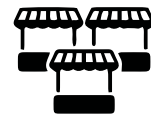

Streetscape  
Power  
Distribution

Please consult serving utility for their requirements prior to ordering or installing, as specifications and approvals vary by utility, and may require local electrical inspector approval. All installations must be installed by a licensed electrician and must comply with all national and local codes, laws and regulations. Milbank reserves the right to make changes in specifications and features shown without notice or obligation.





## Battery Backup Commercial Pedestals

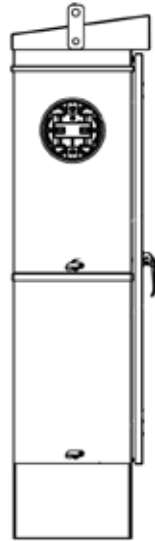
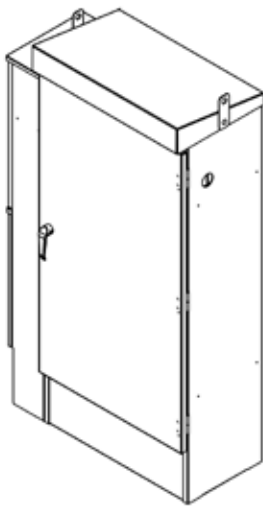

Designed to provide battery backup power for various loads, and to switch specific loads on and off under certain conditions; a photoelectric cell or time clock to control lighting circuits, as an example. Metered and unmetered power distribution options are available. The back-up power pedestal is designed to handle the vast majority of today's back-up power requirements. By using a 19" rack design, shelves can be adjusted to accommodate the required batteries and manufactures DC to AC inverters, transfer switches and other related equipment. This design gives the user a wide range of design and configuration options. Complete turnkey, ready to power-up pedestals are offered along with basic units ready to accept batteries and inverters supplied by others.

### Features

- 100 through 320 Amps meter socket with the option of either a ring type socket (conforms to EUSERC 308) with or without test/bypass blocks or a heavy duty ringless socket with lever bypass
- Separate sealable utility termination compartment
- An isolated separate customer section with service disconnects, power distribution options and power control
- 19" wide rack in customer compartment for easy layout of equipment
- Battery trays
- Thermostat with cooling fan
- Filtered louvers for heat rise flow through ventilation
- Three point door latch (key or pad lockable)

### Note

- May require customization based on regional requirements

### Applications



Traffic Signals



Communications  
Power Distribution

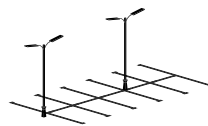

Parking Lots



Camera & Security  
Locations

### Options

- |   |  |   |
|---|--|---|
| <ul style="list-style-type: none"> <li>• Manual bypass switch</li> <li>• Transfer switch for generator power back-up</li> <li>• Generator inlet receptacles 30 Amps through 200 Amps</li> <li>• Pad lockable provision for receptacles</li> </ul> | <ul style="list-style-type: none"> <li>• Police access door</li> <li>• Metered load center distribution</li> <li>• Unmetered load center distribution</li> <li>• Photo electric controls (for street lighting)</li> <li>• Time clocks</li> <li>• HOA switches</li> </ul> | <ul style="list-style-type: none"> <li>• Contactors</li> <li>• GFCI duplex receptacles</li> <li>• Thermostat for heating control</li> <li>• Heating pads or elements</li> <li>• Roll out shelves for batteries</li> <li>• Surge arrestors and lighting arrestors</li> </ul> |
|---|--|---|



Please consult serving utility for their requirements prior to ordering or installing, as specifications and approvals vary by utility, and may require local electrical inspector approval. All installations must be installed by a licensed electrician and must comply with all national and local codes, laws and regulations. Milbank reserves the right to make changes in specifications and features shown without notice or obligation.

## Power Transfer Commercial Pedestals



Providing metered or unmetered AC power, distribution, surge suppression, mechanical interlock and stand-by generator receptacle — all in a neat, compact pedestal.

### Features

- 120/240V 1Ø3W through 277/480V 3Ø4W ratings
- Metered or unmetered units
- Choice of EUSERC ring type or ringless meter sockets
- 60 Amps through 400 Amps ratings
- Pad lockable, isolated utility compartments
- 20 Amps GFCI convenience receptacle
- Lockable recessed generator receptacle door
- Utility and generator indicator light options
- All stainless steel hardware
- Galvanized steel, aluminum or stainless steel cabinet options
- Custom designs available

### Note

- May require customization based on regional requirements



### Applications



Traffic Signals



Pump & Lift Stations



Communications  
Power Distribution

Please consult serving utility for their requirements prior to ordering or installing, as specifications and approvals vary by utility, and may require local electrical inspector approval. All installations must be installed by a licensed electrician and must comply with all national and local codes, laws and regulations. Milbank reserves the right to make changes in specifications and features shown without notice or obligation.





Designed to be used where a smaller service package would be a better choice over larger switchgear equipment, these pedestals have amperage ratings of 400 to 800 Amps at voltages up through 480 volt three phase.

### Features

- Up to 800 Amps
- A low profile CT pedestal
- All utility equipment is isolated in separated pad lockable and sealable compartments
- Separate customer compartment designed to hold distribution and control equipment
- Dead front customer construction
- Optional mounting base
- Optional construction in steel, aluminum and stainless steel
- Wide choice of powder paint colors

### Note

- May require customization based on regional requirements

### Applications

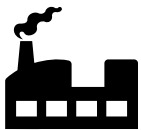

Commercial &  
Industrial Control  
Systems



Pump & Lift  
Stations



Water Treatment  
Plants



Electric Vehicle  
Charging Stations



Please consult serving utility for their requirements prior to ordering or installing, as specifications and approvals vary by utility, and may require local electrical inspector approval. All installations must be installed by a licensed electrician and must comply with all national and local codes, laws and regulations. Milbank reserves the right to make changes in specifications and features shown without notice or obligation.

## Slimline Commercial Pedestals



Provides a sleeker, smaller footprint, with wireway access on the side of the unit rather than the back, allowing maximum flexibility to place the pedestal anywhere physical space is at premium.

Providing unmetered AC power, distribution, surge suppression, mechanical interlock and stand-by generator receptacle — all in a neat, compact pedestal.

### Features

- 100 or 200 Amps
  - Vandal-resistant, secure and attractive design
  - Customer compartment with distribution and control equipment with swing dead front door, secured with both a hasp/latch and draw latch outer door
  - Utility metering compartment protected with a hinged hood, increasing resistance to meter vandalism
  - Small footprint
  - Wireway located on left side of pedestal for utility incoming wire, allowing pedestal to be mounted with back as close as 14" to walls or structures
  - Available in 12" and 20" widths and 50" and 63" (metered) and 43" (unmetered) heights
  - Includes a print pocket for plans and drawings
  - Voltage range: 120V–480V
  - Compatible with both ringless and ring type meter sockets, 4–7 terminals
- Available in a wide array of colors, including but not limited to all ANSI powder coated paint colors upon request
  - Pedestal mounting base option saves time and labor to install on a cement pad—no anchor bolts required
  - Powder coated G90 galvanized steel or Aluminum; raw, anodized or powder coated, as well as stainless steel exterior options

### Note

- May require customization based on regional requirements



Water Treatment  
Plants



Highways



Parks &  
Landscaping



**Direct bury pedestals** offer many advantages. With no need to coordinate, buy or wait for concrete, installation time can be cut down to less than an hour. Traditional direct bury pedestals are awkward to transport and handle and can only be used in a direct bury application. Milbank's modular design offers flexibility and convenience for distributors and contractors alike.



It's constructed with 14 gauge steel and only available for 12" pedestals.

Please consult serving utility for their requirements prior to ordering or installing, as specifications and approvals vary by utility, and may require local electrical inspector approval. All installations must be installed by a licensed electrician and must comply with all national and local codes, laws and regulations. Milbank reserves the right to make changes in specifications and features shown without notice or obligation.



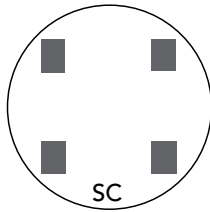

2 and 3-WIRE FORMS 1S & 2S

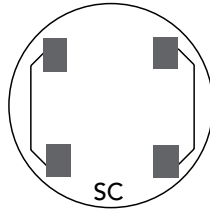

2 and 3-WIRE FORMS 1S & 2S with bypass

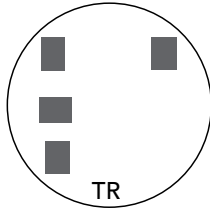

2 -WIRE FORM 3S 5th Term. 9 o'clock

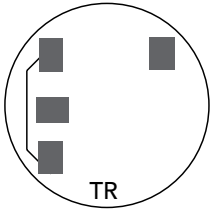

2-WIRE FORM 3S with bypass

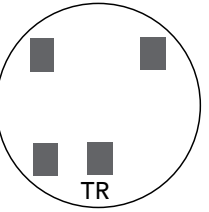

2-WIRE FORM 3S 5th Term. 6 o'clock

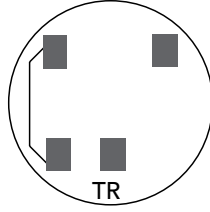

2-WIRE FORMS 3S with bypass

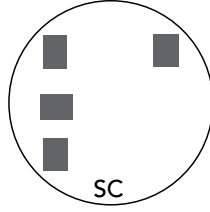

2 ELEMENT 3-WIRE NETWORK FORM 12S 5th Term. 9 o'clock

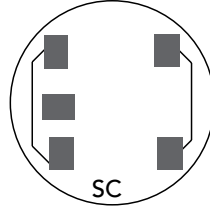

2 ELEMENT 3-WIRE NETWORK FORM 12S 5th Term. 9 o'clock

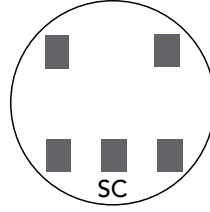

2 ELEMENT 3-WIRE NETWORK FORM 12S 5th Term. 6 o'clock

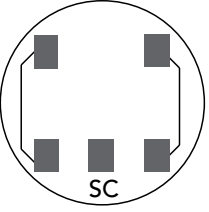

2 ELEMENT 3-WIRE NETWORK FORM 12S with bypass 5th Term. 6 o'clock

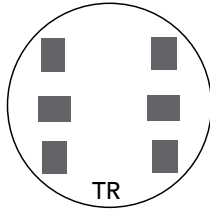

3-WIRE FORMS 4S

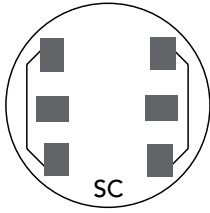

3-WIRE FORM 4S with bypass

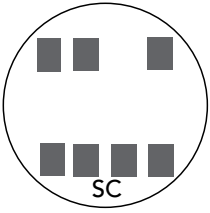

2 or 3 ELEMENT 3Ø4W Y or Δ Y FORM 14S

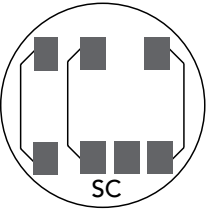

2 or 3 ELEMENT 3Ø4W Y or Δ with bypass

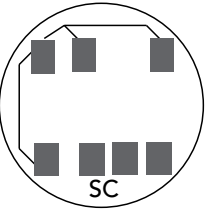

2 ELEMENT 3Ø4W Y or Δ Y FORM 7S Δ FORM 24S with bypass

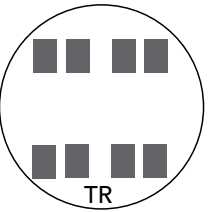

2 ELEMENT 2Ø3W, 2Ø4W, 3Ø3W FORM 5S

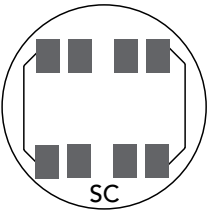

2 ELEMENT 2Ø3W, 2Ø4W, 3Ø3W FORM 5S with bypass

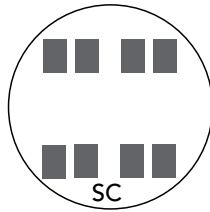

2 ELEMENT 2Ø3W, 2Ø4W, 3Ø3W FORM 13S

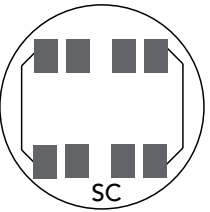

2 or 3 ELEMENT 2Ø3W, 2Ø4W, 3Ø3W FORM 13S with bypass

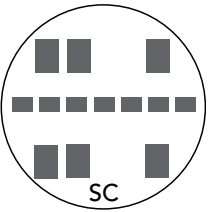

2 or 3 ELEMENT 3Ø4W Y or Δ Y FORM 9S Δ FORM 8S

TR= Transformer Rated  
SC= Self-Contained

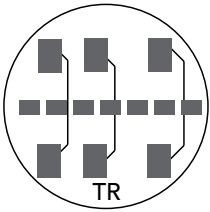

2 or 3 ELEMENT 3Ø3W, Y or Δ FORM 8S & 9S with bypass

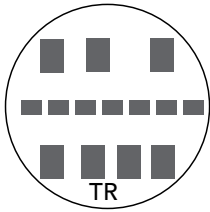

2 ELEMENT 3Ø4W Y FORM 6S

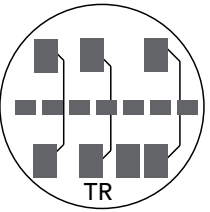

2 ELEMENT 3Ø4W Y FORM 6S with bypass



Please consult serving utility for their requirements prior to ordering or installing, as specifications and approvals vary by utility, and may require local electrical inspector approval. All installations must be installed by a licensed electrician and must comply with all national and local codes, laws and regulations. Milbank reserves the right to make changes in specifications and features shown without notice or obligation.

# Meter Forms

## Reference Information

**DIAGRAM A**  
1Ø2W with 1 P.T.'s & 1 C.T.  
Single Stator Meter(2W1Ø) - Form 3S  
5T Socket, Test Switch #TS04-0101

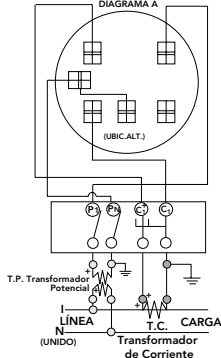

**DIAGRAM B**  
1Ø3W with 1 C.T.  
Single Stator Meter (2W1Ø) - Form 3S  
5T Socket, Test Switch #TS04-0101

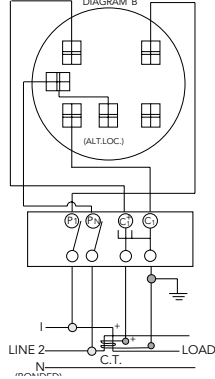

**DIAGRAM C**  
1Ø3W with 2 C.T.'s  
Single Stator Meter (3W1Ø) - Form 4S  
6T Socket, Test Switch #TS07-0105

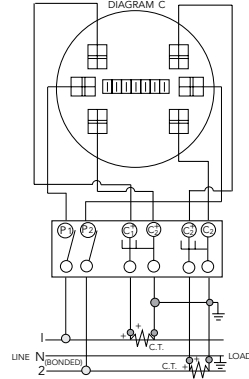

**DIAGRAM D**  
1Ø3W or 3W Network with 2 C.T.'s  
2 Stator Meter - Form 5S  
8T Socket, Test Switch #TS07-0105

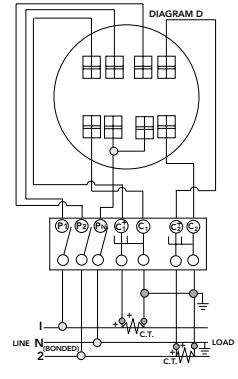

**DIAGRAM E**  
3Ø3W "A" with 2 P.T.'s & 2 C.T.'s  
2 Stator Meter - Form 5S  
8T Socket, Test Switch #TS07-0105

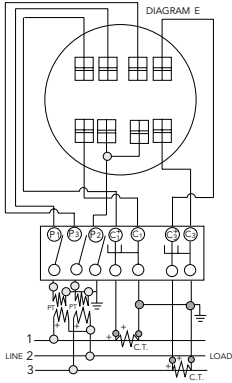

**DIAGRAM F**  
3Ø3W "A" with 2 C.T.'s  
2 Stator Meter - Form 5S  
8T Socket, Test Switch #TS07-0105

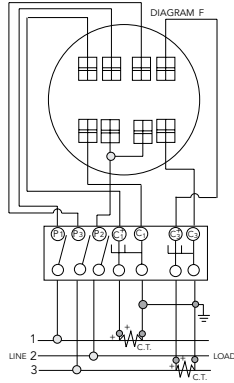

**DIAGRAM G**  
3Ø4W "Y" with 3 C.T.'s  
2 1/2 Stator Meter - Form 6S  
13T Socket, Test Switch #TS10-0109

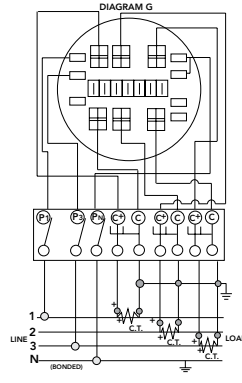

**DIAGRAM H**  
3Ø4W "Y" with 2 P.T.'s & 3 C.T.'s  
2 1/2 Stator Meter - Form 6S  
13T Socket, Test Switch #TS10-0109

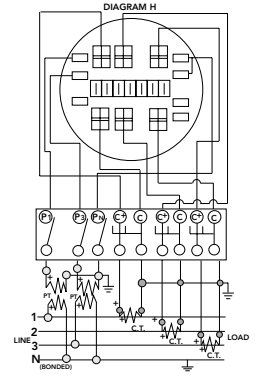

**DIAGRAM I**  
3Ø4W "Y" or "A" with 3 C.T.'s  
"Y" 3 Stator Meter - Form 9S  
"A" 2 Stator Meter - Form 8S  
13T Socket, Test Switch #TS10-0109

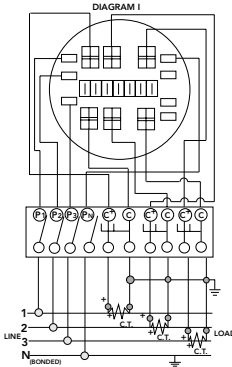

**DIAGRAM J**  
3Ø4W "Y" with 3 P.T.'s & 3 C.T.'s  
3 Stator Meter - Form 9S  
13T Socket, Test Switch #TS10-0109

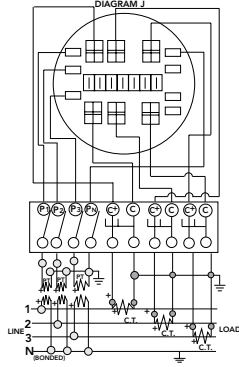

**Prewiring:** If standard factory prewiring is required, refer to wiring diagrams on this page. Determine appropriate diagram and send a copy with order. If custom factory prewiring is required, specify on order. Be sure to include meter socket catalog number, test switch make and catalog number, meter form number and provide a copy of your wiring diagram.

Please consult serving utility for their requirements prior to ordering or installing, as specifications and approvals vary by utility, and may require local electrical inspector approval. All installations must be installed by a licensed electrician and must comply with all national and local codes, laws and regulations. Milbank reserves the right to make changes in specifications and features shown without notice or obligation.



### Important Note

In addition to national and local electrical codes, many utilities have specific requirements for metering equipment. Always consult the serving utility for their specifications and requirements prior to ordering or installing Milbank meter mounting equipment.

### Before Energizing

- A. Give equipment a thorough visual examination to determine that:
  - 1) No shipping or installation damage exists.
  - 2) Proper clearances have been maintained.
  - 3) All connections have been made.
  - 4) Equipment is clean and dry.
- B. Make a thorough examination to:
  - 1) Verify tightness of all bolted connections (see table below).
  - 2) Manually operate all circuit breakers, switches, relays, etc.
  - 3) Check rigidity of all mountings, bus bars and components.
  - 4) Use test equipment to check continuity of circuitry and integrity of insulation.
- C. All switches and circuit breakers should be in the "off" position.
- D. Verify that manual meter bypass (if applicable) is in non-bypass position.
- E. Install cover and/or close doors.
- F. If installation is not being energized at this time, follow "after-energizing" steps listed below. These steps will secure the installation in case of accidental energization.

### When Energizing

- A. Use caution and follow established safety procedures:
  - 1) Wear safety apparel.
  - 2) Use safety equipment.
  - 3) Take action to prevent injury to yourself and others in the event of failure of the installation.
  - 4) Take action to prevent/decrease damage to property in the event of failure of the installation.
  - 5) If you are unsure how to safely energize the installation, get someone who is knowledgeable to do it.

### After Energizing

- A. Secure the installation:
  - 1) To prevent accidental contact with energized parts, cover all openings with approved filler devices.
  - 2) To prevent unauthorized access, secure all covers and/or doors with approved security devices.
  - 3) Attach/post information to advise others of potential hazards associated with the installation.

### Recommended Torque for General Applications\*

Nominal Size	Joint Description		Head Type	Torque (Inch Lbs.)
	Screw	Nut		
10	Brass	Brass Nut or Extruded Hole	All	20-25 inch lbs.
10	Steel	Copper or Aluminum Busbar $\leq 1/8"$	All	25-30 inch lbs.
10	Steel	Steel Nut or Extruded Hole; CU or AL Busbar $> 1/8"$	All	30-35 inch lbs.
12	Steel	Aluminum Extruded Hole	All	30-35 inch lbs.
12	Steel	Steel Nut or Extruded Hole	All	40-50 inch lbs.
1/4	Steel	Aluminum Extruded Hole	All	40-50 inch lbs.
1/4	Steel	Steel Nut or Extruded Hole; CU or AL Busbar	All	50-60 inch lbs.
5/16	Steel	Aluminum Extruded Hole	Hex	60-70 inch lbs.
5/16	Steel	Steel Nut or Extruded Hole; CU or AL Busbar	Hex	100-150 inch lbs.
3/8	Steel	Steel Nut	Hex	150-200 inch lbs.
1/2	Steel	Steel Nut	Hex	200-250 inch lbs.

\* Interior labels typically indicate the required torque for wire connectors and studs, and should be referenced first.  
**CU:** Copper  
**AL:** Aluminum



Please consult serving utility for their requirements prior to ordering or installing, as specifications and approvals vary by utility, and may require local electrical inspector approval. All installations must be installed by a licensed electrician and must comply with all national and local codes, laws and regulations. Milbank reserves the right to make changes in specifications and features shown without notice or obligation.



### Materials

#### Steel Quality

---

The meter equipment listed in this catalog is made of galvanized steel (AISI\* G90) to afford the best possible weather proofing.  
\*American Iron and Steel Institute.

#### Steel Sheet

---

16 gauge, galvanized, sheet: 1 1/4 oz./ sq.ft. class zinc-coated. (AISI G90)  
14 gauge, galvanized, sheet: 1 1/4 oz./ sq.ft. class zinc-coated.

#### Aluminum Extrusion

---

Wire-Terminal: Alloy; 6061-T6, Tin-plated for CU/AL wire.  
Bus Bar: Alloy; 6101-O & 6063-O

#### Aluminum Sheet

---

3000 series aluminum sheet, H14, or 5052 series aluminum sheet, H32. Where applicable thicknesses range from .064-.125

#### Copper Sheet & Bus

---

Electrolytic copper with tin plating in most applications.

#### Insulating Materials

---

- In most units, support bases for current-carrying components are molded from fiberglass reinforced high-strength, track resistant, thermoset polyester molding compounds.
- Clear or black safety shields and polarity barriers are molded from high-strength, track resistant, polycarbonate molding compounds.
- Various sheet insulating materials, as appropriate for the application are utilized in the fabrication of flat, formed and punched component parts and barriers.

### Finish

#### Process

---

Light gray state-of-the-art electrostatically applied powder paint offers a durable, non-fading finish. For further information concerning the chemical analysis of the weather resistant finish, please contact the factory.

#### Metal Fasteners

---

Zinc-coated with a chromate dip.

### Ratings & Compliance

#### Ratings & Compliance

---

All Milbank electrical enclosures in this catalog are rated "Type 3R Enclosure" unless specified otherwise on the product's page. All enclosures with a UL designation are constructed per the appropriate UL Standard and may be installed per the National Electric Code. UL procedure files associated with the UL Standards are listed as follows: Meter Sockets (UL 414, File E30202), Test Switches (UL 414, File E62531), Power Outlets (UL 231, File E90945), Panelboards (UL 67, File E32628) and Pullout Switches (UL 1429, File E133062). Additional standards are utilized as applicable: Meter Sockets (ANSI C12.7), Test Switches (ANSI C12.9) and Panelboards (NEMA PB-1).

Please consult serving utility for their requirements prior to ordering or installing, as specifications and approvals vary by utility, and may require local electrical inspector approval. All installations must be installed by a licensed electrician and must comply with all national and local codes, laws and regulations. Milbank reserves the right to make changes in specifications and features shown without notice or obligation.



6003.....	40	Q130.....	38	U3850-XL-TG-HSP-PL.....	9
6116.....	40	Q250.....	38	U3862.....	5
U5890-X-2/150-HSP.....	21	S8324.....	39	U3949-X-HSP.....	14
U5890-X-2/200-HSP.....	21	U1129-O-K3L-K2L-HSP.....	13	U4363-X-HSP.....	13
*U6267-X-HSP.....	21	U1232-X-HSP.....	25	U4667-X-8528.....	16
5T8K2.....	41	U1233-X-HSP.....	25	U4667-X-9526.....	16
A7514.....	39	U1234-X-HSP.....	25	U4881-O.....	7
A7515.....	39	U1235-X-HSP.....	25	U4881-O-50GB.....	7
A7516.....	39	U1236-X-HSP.....	25	U4881-O-60GB.....	7
A7517.....	39	U1252-X-HSP.....	26	U4908-O-11GR-HSP.....	33
A7518.....	39	U1253-X-HSP.....	26	U5101-XL-11GR-HSP.....	33
A7551.....	39	U1254-X-HSP.....	26	U5136-O-100P-FMG.....	35
A8110.....	39	U1255-X-HSP.....	26	U5136-O-100S-FMG.....	35
A8111.....	39	U1256-X-HSP.....	26	U5136-O-125P-FMG.....	35
A8112.....	39	U1797-O-K3L-K2L-HSP.....	13	U5136-O-125S-FMG.....	35
A9064.....	39	U1980-O-5T-HSP.....	9	U5136-O-150P-FMG.....	35
BL7474.....	41	U1980-O-HSP.....	9	U5136-O-150S-FMG.....	35
BL7499.....	41	U2120-O-HSP.....	15	U5136-O-200P-FMG.....	35
K1047.....	40	U2124-O-HSP.....	13	U5136-O-200S-FMG.....	35
K1190.....	41	U2732-X-HSP.....	28	U5136-O-FMG.....	35
K1350.....	40	U2733-X-HSP.....	28	U5137-O-100P-FMG.....	35
K1350L.....	40	U2734-X-HSP.....	28	U5137-O-100S-FMG.....	35
K1539.....	40	U2735-X-HSP.....	28	U5137-O-125P-FMG.....	35
K1540.....	40	U2736-X-HSP.....	28	U5137-O-125S-FMG.....	35
K1540L.....	40	U2852-X-HSP.....	29	U5137-O-150P-FMG.....	35
K1541.....	40	U2853-X-HSP.....	29	U5137-O-150S-FMG.....	35
K3082.....	40	U2854-X-HSP.....	29	U5137-O-200P-FMG.....	35
K3083.....	40	U2855-X-HSP.....	29	U5137-O-200S-FMG.....	35
K3441.....	40	U2856-X-HSP.....	29	U5137-O-FMG.....	35
K3442.....	40	U2862-X-HSP.....	29	U5842-RL-100-HSP.....	19
K3865.....	41	U2863-X-HSP.....	29	U5842-RL-150-HSP.....	19
K3866.....	41	U2864-X-HSP.....	29	U5842-RL-200-HSP.....	19
K4527.....	41	U2865-X-HSP.....	29	U5844-RL-100-HSP.....	19
K4528.....	41	U2866-X-HSP.....	29	U5844-RL-150-HSP.....	19
K4528.....	41	U2872-X-HSP.....	27	U5844-RL-200-HSP.....	19
K4529.....	41	U2873-X-HSP.....	27	U5864-X-HSP.....	14
K4530.....	41	U2874-X-HSP.....	27	U5882-X-HSP.....	30
K4802.....	40	U2875-X-HSP.....	27	U5882-X-KK-BLG.....	32
K4977-EXT.....	41	U2876-X-HSP.....	27	U5883-X-HSP.....	30
K4977-INT.....	41	U3296-X-HSP.....	11	U5883-X-KK-BLG.....	32
K5022-INT.....	41	U3306-X-HSP.....	12	U5884-X-HSP.....	30
K5815.....	40	U3492-XL-HSP.....	24	U5884-X-KK-BLG.....	32
K5815.....	40	U3493-XL-HSP.....	24	U5885-X-HSP.....	30
K5830.....	40	U3494-XL-HSP.....	24	U5885-X-KK-BLG.....	32
K5935-10GR.....	37	U3495-XL-HSP.....	24	U5886-X-HSP.....	30
K5935-11GR.....	37	U3496-XL-HSP.....	24	U5886-X-KK-BLG.....	32
K5935-2/1450.....	37	U3505-XL-TG-HSP.....	10	U5891-X-2/200-MLK-HSP.....	21
K5935-36GR.....	37	U3506-XL-TG-HSP.....	10	U5902-X-HSP.....	30
K5935-41.....	37	U3566-X-HSP.....	15	U5902-X-KK-BLG.....	32
K5935-54.....	37	U3802.....	5	U5903-X-HSP.....	30
K5T.....	41	U3812.....	5	U5903-X-KK-BLG.....	32
M5-144.....	40	U3822-20GWR.....	6	U5904-X-HSP.....	30
Q120.....	38	U3832.....	5	U5904-X-KK-BLG.....	32



Please consult serving utility for their requirements prior to ordering or installing, as specifications and approvals vary by utility, and may require local electrical inspector approval. All installations must be installed by a licensed electrician and must comply with all national and local codes, laws and regulations. Milbank reserves the right to make changes in specifications and features shown without notice or obligation.

U5905-X-HSP .....	30	UAP6542-RL-5T9-HSP .....	18
U5905-X-KK-BLG .....	32	UAP6601-X-2/200-5T9-HSP .....	22
U5906-X-HSP .....	30	UAP6602-X-2/200-5T9-MLK-HSP .....	22
U5906-X-KK-BLG .....	32	UAP7021-RL-TG-HSP .....	9
U6115-X-2/200-K7L-HSP .....	23	UAP7040-O-TG-HSP .....	9
U6227-X-400-K3L-HSP .....	23	UAP7040-XL-TG-5T-HSP .....	9
U6229-X-400-K7L-HSP .....	23	UAP7040-XL-TG-HSP .....	9
U6266-XTL-100-HSP .....	20	UAP8435-XL-TG-5T-HSP .....	8
U6266-XTL-150-HSP .....	20	UAP8435-XL-TG-HSP .....	8
U6266-XTL-200-HSP .....	20	UAP9551-X-QG-HSP .....	11
U6267-X-2/150-HSP .....	21	UAP9700-RRL-QG-HSP .....	12
U6267-X-2/200-HSP .....	21	UAP9701-X-QG-HSP .....	12
U6272-X-HSP .....	13	USSP6419-O-HSP .....	18
U6273-X-HSP .....	13	USSP6421-O-HSP .....	18
U6396-O-100-10GR-HSP .....	36	USSP6542-O-5T9-HSP .....	18
U6396-O-200-10GR-HSP .....	36	Z1102270 .....	37
U6419-XL-HSP .....	18	Z1115081 .....	37
U6421-XL-HSP .....	18	Z1139163 .....	37
U6542-RL-5T9-HSP .....	18	Z701776-MO .....	38
U6601-X-2/200-5T9-HSP .....	22	Z703916-AC .....	17
U6602-X-2/200-MLK-HSP .....	22	Z703917-AC .....	17
U7021-RL-TG-HSP .....	9	Z703918-AC .....	17
U7040-O-TG-HSP .....	9	Z703919-AC .....	17
U7040-XL-TG-5T-HSP .....	9	Z703921-AC .....	17
U7040-XL-TG-HSP .....	9	Z704693-AC .....	17
U8435-XL-TG-5T-HSP .....	8	Z704693-AC .....	17
U8435-XL-TG-HSP .....	8	Z704694-AC .....	17
U9550-RRL-QG-HSP .....	11	Z705420-AC .....	17
U9551-X-QG-HSP .....	11	Z705456-AC .....	17
U9700-RRL-QG-HSP .....	12	Z708080-MO .....	38
U9701-X-QG-HSP .....	12	Z708145-AC .....	17
U9801-X-QG-HSP .....	11	Z708767-MO .....	38
UA4667-X-8529 .....	16	Z802965-AC .....	41
UA4667-X-9527 .....	16	Z814898-AC .....	41
UAP1252-X-HSP .....	26	Z819294-SC .....	37
UAP1253-X-HSP .....	26	Z901925-AC .....	41
UAP1254-X-HSP .....	26	Z903274-AO .....	41
UAP1255-X-HSP .....	26	Z904486-AO .....	41
UAP1256-X-HSP .....	26	Z916264-AO .....	41
UAP2124-O-HSP .....	13	Z916265-AO .....	41
UAP3296-X-HSP .....	11		
UAP3306-X-HSP .....	12		
UAP3505-XL-TG-HSP .....	10		
UAP3506-XL-TG-HSP .....	10		
UAP3566-X-HSP .....	15		
UAP3949-X-HSP .....	14		
UAP5024-XL-FMG .....	19		
UAP5844-RL-100-HSP .....	19		
UAP5844-RL-150-HSP .....	19		
UAP5844-RL-200-HSP .....	19		
UAP5864-X-HSP .....	14		
UAP6272-X-HSP .....	13		
UAP6419-XL-HSP .....	18		
UAP6421-O-HSP .....	18		

Please consult serving utility for their requirements prior to ordering or installing, as specifications and approvals vary by utility, and may require local electrical inspector approval. All installations must be installed by a licensed electrician and must comply with all national and local codes, laws and regulations. Milbank reserves the right to make changes in specifications and features shown without notice or obligation.







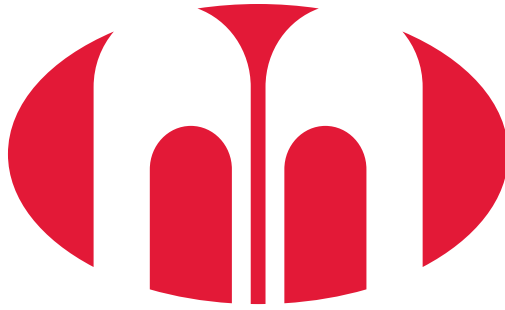

# MILBANK<sup>®</sup>

ENERGY AT WORK

