

TYPHOON

OWNER'S MANUAL

CONTENTS

| | |
|--|-------|
| Instructions | 1 |
| Warnings | 2 |
| Explanatory diagram of the overall ebike configuration | 3 |
| Schematic diagram of the electric bicycle | 4 |
| Main technical parameters | 5 |
| Throttle control | 6 |
| Correct operation stages | 7 |
| Pedal assist mode control | 8,9 |
| Error codes | 10 |
| Charging the battery | 11,12 |
| Seat adjustment | 13 |
| Disc brakes | 14 |
| Tire pressure and brake adjustment | 15 |
| Chain adjustment and Hall sensor | 16 |
| Maintenance table | 17 |
| Power shut off troubleshooting | 18 |
| Handlebar adjustment | 19 |
| FAQ | 20 |
| Storage and disposal | 21 |
| Contact us | 22 |

Instructions

1. Please read the manual carefully before using your EMOJO electric bicycle.
2. Make sure all parts are locked tightly, such as the frame joint, handlebar, seat post and pedal, etc. Before using. Do not use the electric bicycle before carefully reading the instructions and knowing about the performance of the electric bicycle. Do not lend the electric bicycle to anyone who does not know how to operate it.
3. Develop a habit of charging when the power of the battery pack shows a red light. Please charge and maintain the battery pack consistently to have longer service; if the bicycle is not to be used for a long period, it is suggested to turn power of the battery pack to the OFF position and charge-discharge the battery once per month.
4. Frequent braking, starting, uphill, still starting, muddy and uneven ground, overloading of people and goods will assume larger electricity, thus influencing the travel mileage. If you want to get the best travel mileage, we suggest you follow the following instructions:
Ride the bicycle to a certain speed by pedaling prior to turning on pedal-assist or throttle power.
Try to decrease the frequency of braking and starting while maintaining safe riding habits.
Please assist with pedal when the slope angle is steep, or the wind speed is fast.
5. When you lift the battery, please do not insert any metal objects (such as wires, keys, etc) into the charging socket or bridge the negative and positive poles of the battery cell. This can cause battery short-circuit, resulting in a fire and putting your safety at risk.
6. This e-bike is **not intended to be ridden through water**. When the water level inundates the controller, electrical circuitry or motor hub, it is possible that it will cause short circuit and damage the circuit, please pay attention to avoid burning down the electronic control system!
7. The standard load weight of this bike is 300 lbs. (including the cyclist), overloading may cause the travel mileage to decrease, or cause the spare parts of the bicycle to be damaged and reduce the working life of battery.
8. Warranty will be void if a non-approved battery charger or other non-original EMOJO spare parts are used.
9. Minors, pregnant women or anyone that does not have full dexterity of hands and legs should not use this product.
10. Please check the tightening state of front axle, bottom bracket shell, rear axle, etc. frequently in use.
11. Children younger than 16 should not ride the electric bicycle.

Warnings

Please pay attention to the following items for your safety:

| | |
|---|---|
| Disassembling and refitting the bicycle may bring hidden safety hazards to your electric bike, therefore, causing risk. | Make sure to check the set up and stability of the brakes, saddle, frame, handlebar, wheels , etc. before riding to make sure all is in proper working condition. |
| Downhill speed should be moderate, please do not apply the front brake fully when slamming the brakes at high speed to avoid the front wheel from locking and losing control. | Avoid riding through sharp objects like stairs or rocks which can damage the tires and wheels. |
| The brakes should not be oiled to avoid causing iffy braking and endangering your personal safety. | Do not attach any objects to the handlebar that may obstruct your vision or handling. |
| Wear appropriate protecting apparel when riding under the rain. Never use an umbrella and/or operate the bicycle with one hand. | This bicycle is for a single rider, not intended to carry any passengers. Always wear a helmet. |

Battery warnings

| | |
|---|---|
| Do not keep, approach or store the battery near high heat sources. Avoid areas near flammable or explosive liquids or gas. | Do not attempt to short-circuit the battery electrodes, which can damage the battery, the bicycle controller and the charger. |
| Do not disassemble the battery case, do not attempt to make any modifications or external connections. You will lose your warranty. | Do not drop the battery, do not immerse in water and keep it away from high-humidity areas. |

Battery warnings

| | |
|--|--|
| Do not tamper or disassemble the charger. Avoid dropping or smashing it violently. | Charge your battery in a well ventilated area, free of humidity and far from flammable or explosive objects. |
| Always keep your hands dry while plugging and unplugging the power plug and when handling the battery. | While charging, there should be no foreign objects on the charger or the battery shell. |
| The battery is not a toy, do keep children away. | Avoid contact between teh conductive objects and the battery poles at the same time to avoid short-circuit and damaging the battery. |

Explanatory diagram of the overall ebike configuration



Aactual product may slightly differ from this picture

Schematic diagram of the electric bicycle

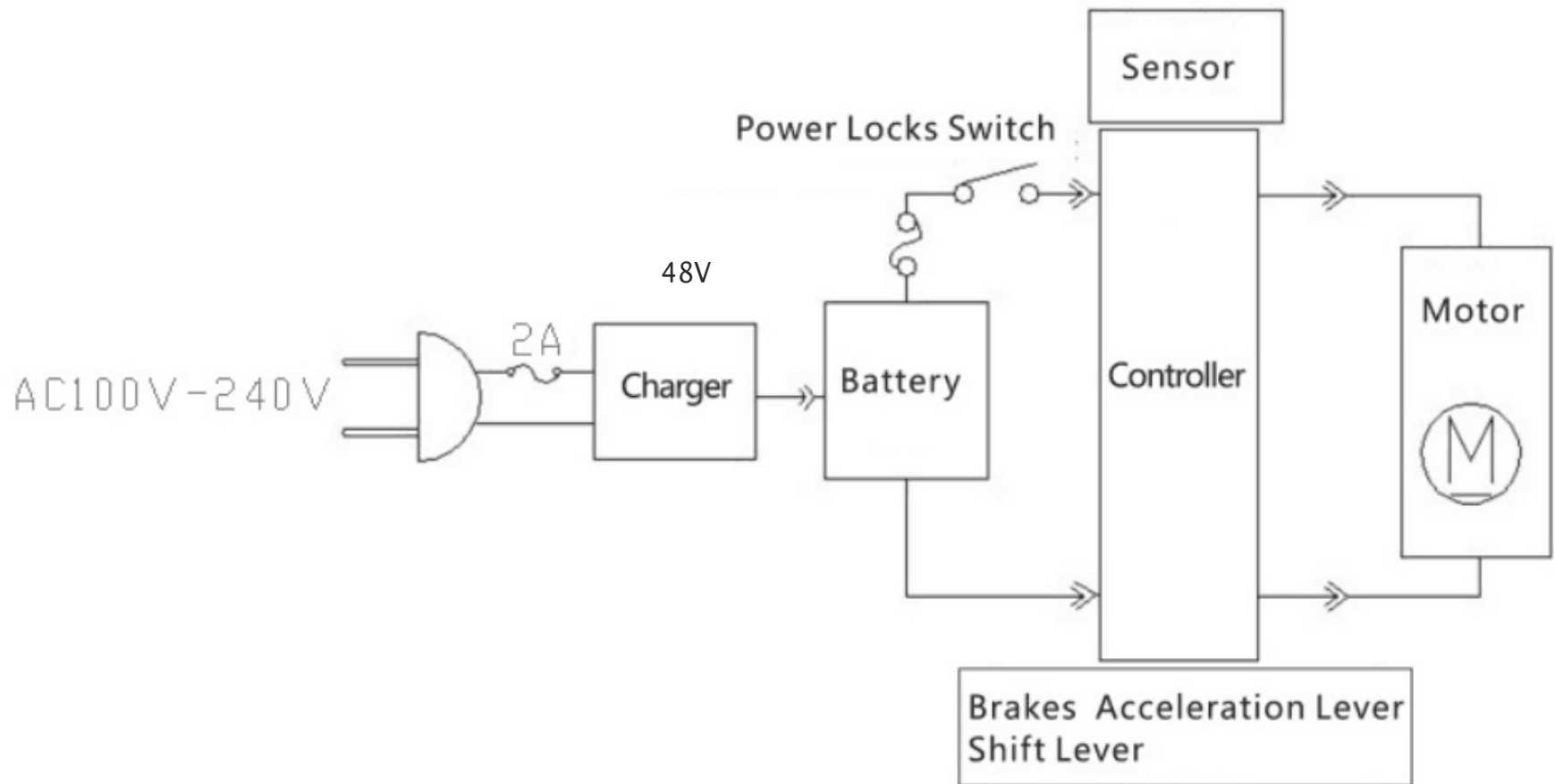

Main technical parameters

| Item | | Index |
|--|-------------------------------|---|
| Total bicycle weight in lbs. | | 70 Lbs |
| Max. load (including cyclist, passenger and cargo) | | 300Lbs |
| Travel Mileage on a single Charge Miles w/PAS | | Winter:60 miles Summer: 65miles |
| Power Consumption on a single Charge (kilowatt) | | <0<0.6 .6 |
| Power Consumption per Kilometer (kilowatt) | | <<1.22 |
| Battery | Type | Dual lithium Ion Battery 48 V |
| | Voltage / Capacity | 12 amps and 9 amps |
| Motors | Motor Type | PPermanent Magnet DC Hi-Speed Motor 500W |
| | Rated output power | 30.5V±0.5V/41.5 V±0.5V |
| | Rated voltage | 48 V |
| Protection | Under-voltage | 30.5V |
| | Controller | 15A+/- |
| Charger | Over-current Protection Model | 48 v 2A |
| | Duration ofCharge | 4 to 5 hours (instant charge after 2 hours) |
| | Main Appliance Input Voltage | AC 110-220V |
| | Main Appliance Output voltage | 48 V |
| | Charging Current | 2 A |

Hand Throttle Control

Your electric bike is equipped with a power and throttle control on the right hand side. To power on your bike first make sure to turn on your bike by pressing and holding the M button on the left side.

You control the throttle by twisting the right grip section, the farther you push from its resting position, the more power is delivered to the motor to accelerate. When you want to slow down, you simply release the throttle and let it return to its resting position and simultaneously apply the brakes.



Gear shifter

Twist throttle

When the pedal assist mode is set to "0", the pedal assist and throttle function(s) do not engage. When the pedal assist mode is set to "5" the pedal assist function will engage to the maximum speed level and the throttle will accelerate the bike forward. The throttle control is operated on the right hand side.

When you want to slow down, you simply release the throttle and let it return to its resting position and simultaneously apply the brakes.

Mechanical gears

This EMOJO electric bike is equipped with 7 mechanical gears in addition to the pedal assist levels. The first gear is for easier and uphill pedaling, the last gear is for maximum speed on leveled ground or downhills. Change gears only when pedaling. The rear wheel contains seven chain sprockets. When the chain is around the largest sprocket, you are in the 1st gear which is the "lowest" gear. The high gear will have the dérailleur positioned so that the chain is directed around the smallest gear selector and cause it to change gear. Adjustments require fine tuning and should be made by a qualified technician.

Avoid changing gears rapidly from 1st to the 7th gear or vice-versa. If you change multiple gears too quickly, you could have the chain come off the front sprocket.



Derrailleur



7-gears cassette

Correct operation stages

! Warning:

! "For your safety, please practice in a closed track the first time you ride your ebike". After mastering the controls of an electric bicycle, you may ride on regular roads and follow the traffic rules consciously. Do not let inexperienced people ride the electric bicycle, do not disassemble and refit the electric bicycle. please pay attention and brake in advance to allow longer braking distance in rainy or snowy weather.

Start: Switch to On the button on the right side of the rear battery, then press the M button on the handlebar. Both batteries are turned on at the same time and they are both providing power at the same time. They do not work separately.

Motor On/Pedal Assist

Start pedaling and the electric bicycle will drive forward normally. If you stop pedaling, the electric motor will stop working, but it will still drive forward a short distance because of inertia.

You can adjust the level of electric assistance by toggling the up and down arrows. There are 5 levels of electrical assistance, level 5 being the highest.

Dual motor engaging

You can choose to ride with the assistance of the 2 electric motors (front and rear), rear only or front only.

On the left handlebar grip, there is a button with the numbers 1,2,3.

1=Rear motor engaged

2=Both motors are engaged

3-Front engaged

Throttle only

You can use the twist throttle only and the bicycle will move without you having to pedal. Click the M button on the handlebar control to turn on the system, with your right thumb press down the throttle, the further you push the throttle the faster it accelerates. To stop or reduce the speed release the throttle and apply the brakes the electric motor will stop working, but it will still drive forward a short distance because of inertia.

Note: A: For your safety concern, please hold the grip tightly with both hands while riding, and please brake in a timely manner when necessary. B: This bicycle has the function of brake power cut. The brakes will cut off the motor power to ensure safety of riding. Always check your brakes and cables before riding.

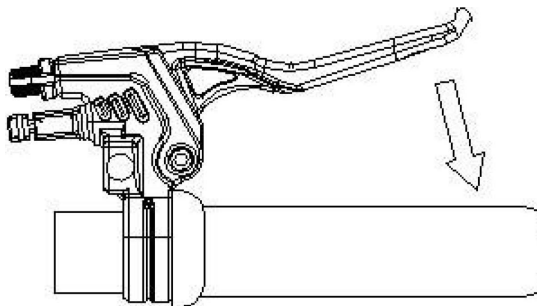

Pull to brake. Brake sensor will shut off motor power.

M button

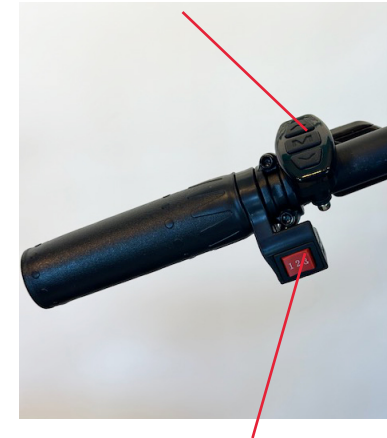

Motor selector



Battery On switch

Pedal Assist Mode Control

Please read the following steps and images to help you understand how to read and operate all the functions.

◆ Display Interface

After switching on the ebike system, the display shows current speed and total distance except, battery indicator and assistance level

◆ To change the indicated information, press the MODE button to show in turn as follows: Current Speed (Km/h) → Trip Distance (Km) Trip Time (Hour) → Max. Speed (Km/h) → Avg. Speed (Km/h) → Motor-output (W) → Current Speed (Km/h).

◆ Switching PAS Off: There is a preset setting which allows your bike to cruise at a steady speed of 3.7 MPH (6Km/h), the letter "P" is shown at the screen. To engage this cruise control feature press and hold the "-" button for a few seconds until the letter "P" shows on the screen. To disengage this function press the brakes.

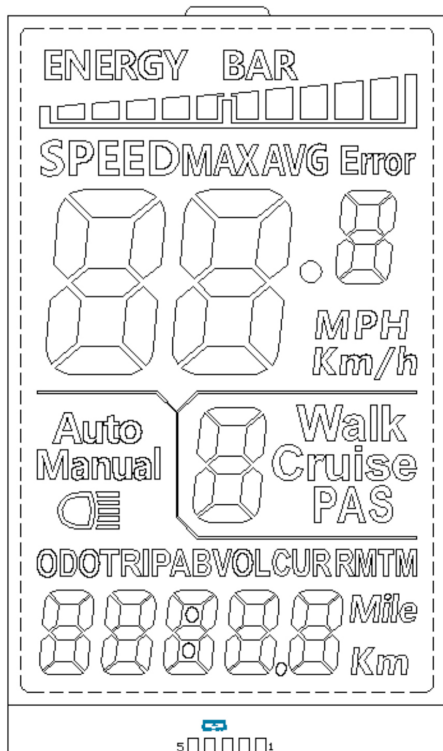

◆ Manual Clearance Function

Among of all functions, Trip Distance, Trip Time, Max. Speed and Avg. Speed, can only be cleared manually. If the above functions need to be cleared, After switching on the E-bike system and parking the E-bike, please to hold the **MODE** button and the **DOWN** button for 2 s, the above functions can be cleared at the same time.

Press the power button (M button) on the handlebar controls located near the left grip to turn it on.

You can adjust the pedal assist power level to have more power by hitting the [+] button (right button) and can move to a lower level power by hitting the [-] button (left button).

When not riding your bike, you can turn off the meter by holding down the power button (M button) for several seconds.

Pedal Assist Mode LCD Screen

The LCD meter monitors pedal assist, speed, odometer, trip distance, riding time, and battery energy level. To turn the meter on, make sure the battery is fully inserted into the bike.

Press the power button (M button) on the two button selector located near the left grip on the handlebars to turn the meter on. You can adjust the pedal assist power level to have more power by hitting the [+] button (first button top to bottom) and can move to a lower level power by hitting the [-] button (third button top to bottom).

When not riding the bike, you can turn off the meter by holding down the power button (M button) for several seconds.

BATTERY LEVEL
(Shows the power of the frame-integrated battery only) To check the rear battery level press the test button directly on it.

SPEED

LIGHTS ON/OFF

RIDING MODE

ODOMETER/TRIP

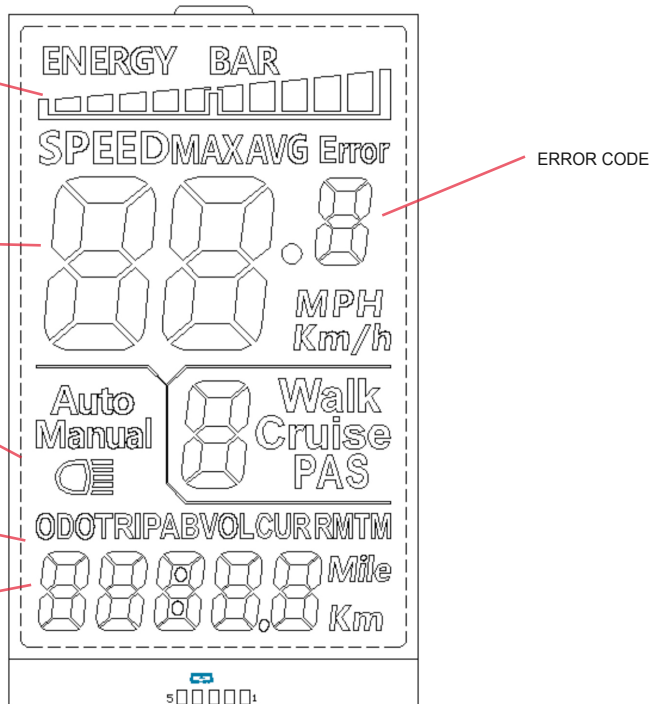

Free Ride

Pedal just like a normal bicycle with all the display features active.

Throttle Only

Full power on demand. No automatic pedal assistance.

Display functions

1-Power On/Off

Press the M button to power on the display. To power off display and power supply to the bicycle press and hold for 3 seconds

2-Pedal assist (PAS)

The system has 5 PAS assistance modes, use the + -buttons to scroll between modes

3-Riding Modes

Walk: Walking boost, Cruise: Constant speed cruise, PAS: Pedal assist levels.

4-Multi function display

Press the M button once to switch between Total Mileage: ODO, Single Mileage: TRIP A, Single Mileage: TRIP B, current Voltage VOL, operating Current: CUR, Display Booting Time: TM, **Riding Time**
The riding time will be saved up to 100 hours unless you reset it

5-Battery Level Indicator (Energy bar). Shows the power of the frame-integrated battery only. To check the level of the rear battery press the test button directly on the battery.

Indicates battery level, there are 5 levels, each segment stands for 20% charge

6-Speed indicator: Show the speed in Km/h or MPH

7-PAS Level: Indicates the level of motor assistance. Use the+ - buttons to switch between PAS levels

8-Lights: Turn your display ON, then press and hold the UP arrow for a few seconds to turn on the lights. To turn them off press and hold again the UP arrow.

Error codes

In the event of a system malfunction the screen will display an error code. You can troubleshoot the problem by identifying the code from the following chart.

| Error Code | Definition |
|------------|-------------------------------|
| 0 | Normal system, no error |
| 1 | Reserved, no function |
| 2 | Brake sensor error |
| 3 | PAS sensor failure |
| 4 | 6 km/h capped top speed |
| 5 | Real time cruising |
| 6 | Low battery |
| 7 | Electric motor failure |
| 8 | Throttle failure |
| 9 | Controller failure |
| 10 | Communication-receiving error |
| 11 | Communication-sending error |
| 12 | BMS communication error |
| 13 | LED light failure |

End user adjustable settings

The display allows for a series of adjustments on the settings, however some are reserved exclusively for the use of a certified technician of the manufacturer. For those others within reach of the end user please follow the below list of settings.

To enter the program mode, press and hold the UP and DOWN arrows for a few seconds. Use the M button to navigate through the settings and up and down to change settings in each program. The settings will automatically save if you leave the display to go back to the home screen:

P01: Back-light Brightness (1: darkest; 3: brightest)

P02: Mileage Unit (0: KM; 1: MILE)

P04: Display sleep time (0: never, other figures refer to the sleep time) Unit: minute

P08: Speed Limit

Range: 0-100km/h, parameter 100 indicates no speed limit.

This parameter limits the max. speed of the vehicle.

For example, input value 25 means the max. speed is 25km/h, the vehicle traveling speed can only reach the preset value. Deviation: ± 1 km/h (applies to both PAS and throttle mode).

Note: The above-mentioned values are measured by metric unit (kilometers). When the measuring unit is switched to imperial unit (mile), the speed value displayed on the panel will be automatically switched to corresponding imperial unit, however the speed limit value in the imperial unit interface won't change accordingly.

P16: ODO Zero-Out: Long press the upper key for 5 seconds and ODO will zero out.

Charging the batteries

1. Always charge the batteries fully for the first time. When the battery level is low (20% or less), plug it to charge it, use only the original charger provided with the battery.



Slide open the protective hatch to access the charging port on the batteries.
For the frame built-in battery the access hatch is on the back left side, for the vertical-mounted battery behind the seat pole the access hatch is on the top right side.

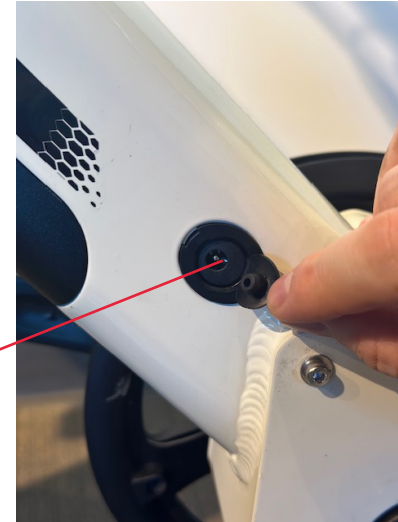

2. Insert the charging pin of the charger into the battery charging plug; pay attention to the direction of the pins, do not insert any other foreign objects or dismantle
3. Connect the power plug of charger into a household AC power outlet. Please do not insert the plug into the AC around water or with wet hands, avoid causing electric shock hazards.
4. Please check the charger indicator. When the LED indicator on the charger is red, it indicates the battery is charging, when the indicator is green, it indicates charging completed.



5. After charging completes, please pull out the charger power plug from the household AC and disconnect the plug from the battery

Attention:

1. Make sure the charger is the original charger.
2. All charging plugs must be inserted tightly.
3. The average charging time of the whole battery pack is 5 hours, please operate in strict accordance with above instructions and keep charger away from children.
4. Please do not charge under the rain or in wet environments..



Battery mounting and removal

Installing the battery

Your bike comes with 2 batteries, one is installed and integrated into the main frame, the second is mounted behind the seat pole. You will seldom need to remove the batteries, but shall you need to remove one or both for replacement or to perform a deeper cleaning on your ebike you can easily do it:

Park the electric bicycle. To remove the frame battery, turn the key clockwise (Fig. 1) until battery front section is free, hold the battery on the front side with one hand and gently pull it out (Fig. 2). Use both hands to pull the battery out. To remove the stand-alone battery, unlock it (Fig. 3) and gently slide it up and then outwards with both hands (Fig. 4)

Turn the key on both batteries to unlock/lock them.



Fig.1



Fig.2



Fig.3



Fig.4

Warning!

Note: While installing and removing, do not use extreme force to avoid damaging the battery pack and other components.

Seat adjustment

Adjust the seat to the proper height.

- a) Release the clamp lever
- b) Lift or push the seat pole to the desired height
- c) Close the clamp lever tightly to lock the seat into position.

Please note that when adjusting the height of the seat post, it has to keep the inserting depth above the safety line, if you rise the post beyond the safety line it may fall off while riding, no matter how tight it is.

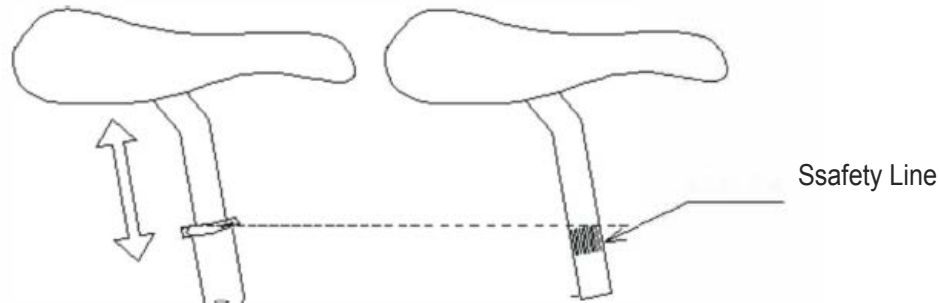

Disc brakes



Your electric bike is equipped with disc brakes for maximum reliability. Applying hand pressure to the brake levers will engage the brake pads against the brake rotor, creating friction and slowing down the wheel. The more hand pressure applied to the brake lever, the faster the bike will come to a stop. Check the front disc handle gap by depressing the brake lever about 10 times to check that everything is operating correctly (Fig. 1) If necessary you can adjust the brake by turning the dial on cable (shown with a red arrow). Your front wheel must spin free at all times without any friction from the brake when not applied.

The rear brake should always be applied before or along with the front brake. Applying only the front brake to slow or stop at high speeds may result in the rider being ejected from the saddle and continuing forward over the handlebars. It is best to apply even pressure to both brake levers when slowing or stopping.

Bicycles equipped with disc brakes will occasionally make a slight scraping noise when the wheels are turning without the brakes being applied. This is normal.

Make sure that the brake lever does not contact the handlebar when full hand pressure is applied (b) The contact point should feel firm and solid. If the lever travels all the way to the handlebar or feels spongy, they may require service by a qualified bicycle technician.

If the brakes are still not operating correctly, they may require further adjustment by an experienced bicycle mechanic.

Figure 1

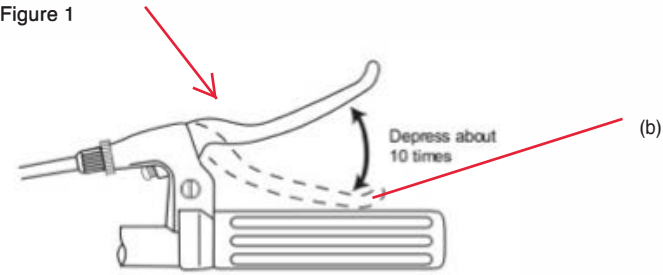

WARNING:

- Disc brake rotors become hot during use. Do not touch or come in contact with the disc rotor shortly after use.
- Wet weather will require a longer distance to stop. Brake earlier and avoid sudden stops when riding in wet conditions.

New Brakes Bed-in Procedure

New brakes will require a "bed-in" procedure prior to your first ride which will ensure the most consistent and powerful braking feel.

Find a safe riding area that will allow for moderate speed. Remain seated during the entire procedure for optimal results.

IMPORTANT: The caliper might need to be adjusted and aligned to ensure there is no constant friction when the brake is not applied avoiding unpleasant noises, premature wear or poor braking. If necessary, adjust your calipers by loosening the sockethead bolts, and gently moving the caliper with your hand until it is centered and aligned with the disc. While holding with your hand the caliper in the correct position, tighten the adjustment bolts again.

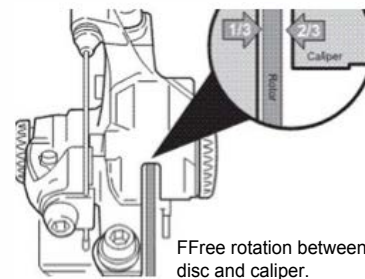

alignment adjustment bolts

Caliper

Disc

4. Pedal Installation and Adjustment:

Take out pedals from the accessory box, install one of the pedals (pedals are marked with the letters "L" and "R" to indicate the side they belong to). When installing the pedals, insert the wrench stuck on the flat end of pedal axial head, and twist into the crank in clockwise direction.

5. Check and Adjustment of Tire Pressure

Keep proper air pressure, the space between tire and ground contact is about 4 inches long when riding on the electric bicycle.

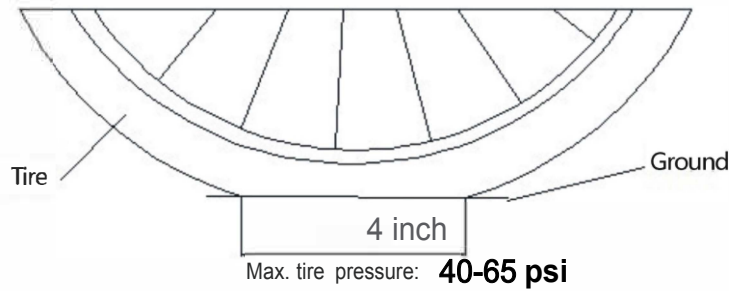

Tire size: 24 x 3.0
Tube size: 24 x 3.0

6. Brake Adjustment

- A. When brake lever reaches 1/3 of unstressed state, the power will be cut out completely, when it is at 1/2, bike can brake completely.
- B. The distance between brake pad of front wheel and rim should not be more than 2mm, when the brake pads wear down, timely adjustment is possible, after adjustment, the brake pad should not interfere with other spare parts. When a worn brake pad reaches 1/2 of its thickness, it must be replaced.

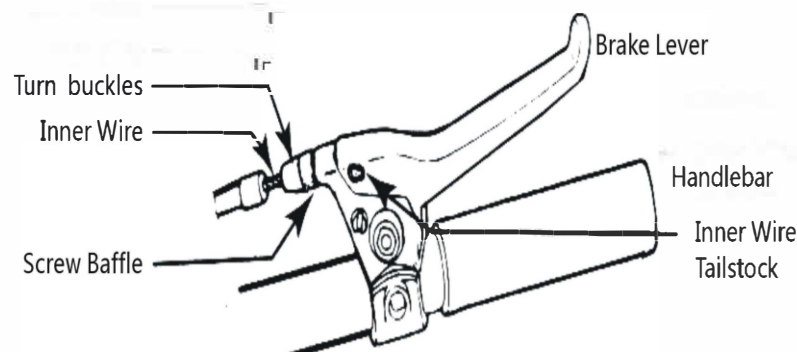

7. Adjustment of Power Assisting Hall Sensor

A: Turn the bike upside down, have it rest on the floor.

I: The distance between the sensor and the disk shall be 3-5 millimeters
Installing the sensor on the side of chain ring, when forwarding the chain ring, the power assistance is effective.

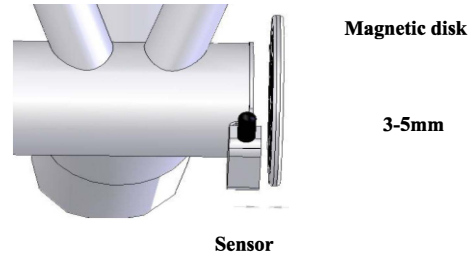

8. The Adjustment of Chain Tension The over relaxation of the check and adjust regularly. The chain would cause chain failing thus threatening safety or damaging the motor. It is suggested to adjustment requirements: in case of single constant speed, when fixed gear, press the chain with hand, the range of the tension is within 10mm from horizontal line.

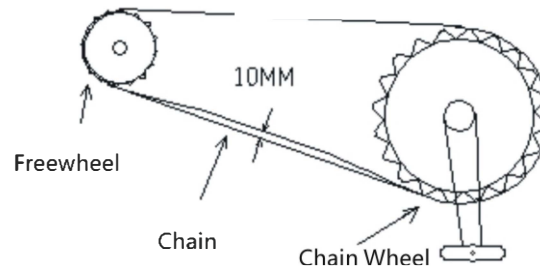

Common Faults and Maintenance

Common Faults

Troubleshooting

Power on, there is no indicator on meter: Twist the throttle, the motor does not work:

Motor kicks in, but speed is low

Short Mileage

Abnormal Noise of the Bike

Check the battery power, if battery is low, it is possible that the power will fail, or some blown fuses of the controller are burned out.

Check whether the speed controlling wire of left brake levers fail, and whether the connector of the controller or motor fails.

Check whether the brake is locked, the tightness of chain is proper; the air pressure of tire is proper; check whether the battery power is full, if not, please charge the battery.

If the battery has not been in use for a long time, please recharge the battery in advance.

Check whether the brake rubs against the rim because of tightness, and whether the tire pressure is full. Check whether the battery is full, if not, please recharge it.

Check for all screws and bolts to be properly tightened.

| | |
|-----------------------------|--|
| Battery Not Charging | Check the charger and power. Check whether the battery connection is in good condition and is stable. Check whether the charger plugs board fails. Check for any blown fuses in the battery case or any disconnected wiring. |
|-----------------------------|--|

Note: if you experience problems contact your retailer, dealer or the manufacturer.

Regular maintenance table

| I: Inspection A. Adjust R: Replace L: Lubrication T: Tight lock | | | |
|--|------------|----------------|----------------|
| Items to be Inspected | 60 days | 180 days | 360 days |
| 1. If the steering of handlebar loosens or wears down | A, T | I, L2 | I, L2 |
| 2. If pedal, axis loosens or wears down | T | I, LI | I, LI |
| 3. If the tire inflation is proper and the cover tire wears down | | I | R |
| 4. If anterior- posterior axis shift, axis bowl, hub spindle loosens or wears down | T A, LI | I, L2 A, LI | I, L2 I, LI |
| 5. If middle axis bowl, hub spindle, axle cap loosens or wears down | A, L2 | A, L2 | I, L2 |
| 6. If the chain is loose | | R | R |
| 7. If the brake shoe wears down | | I | I |
| 8. If the wheel rim deflects or deforms | | I | I |
| 9. If the frame and front fork deform or are damaged | | I | I |
| 10. If spokes break down or becomes loose | I | I | I |
| 11. If the brake operates smoothly | A | A | A |
| 12. If brake lever is at its proper position | | I | I |
| 13. If the reflector is dirty or damaged | | I | I |
| 14. If the horn is loud or the front light is bright | | | I |
| 15. If the charger plug and power line wears down or breaks off | A | A | A |
| 16. If the height of saddle and handlebar is proper | | | |
| 17. All screws positions are tight | I | I, T | T |

Note: LI- recommends using No.68 IIL hydraulic Lubricant L2- recommends using No2. Calcium-based Grease.

Power Shut Off Troubleshooting

If your electric bicycle experiences a sudden power shut off while in use, this can be related to several reasons but the problem has an easy fix.

PROBLEM

The LCD starts to blink repeatedly followed by a power shut off. (Make sure the battery is not depleted)

1-Check the front motor quick connector on the right side of the front wheel. Fig. 1

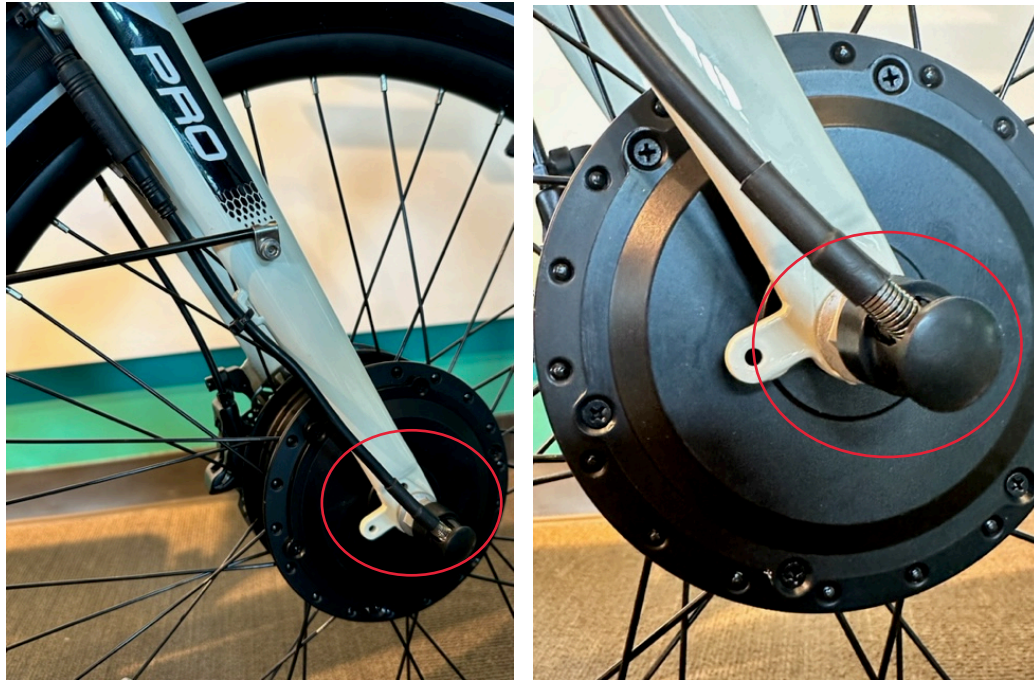

Fig. 1

If the battery is not depleted and the quick connector cable is all in place, contact your shop or EMOJO tech support at support@emojobike.com.

Register your ebike

To activate your warranty please register your ebike online.

You can scan with your phone this QR code and fill in the information, it takes 2 minutes!

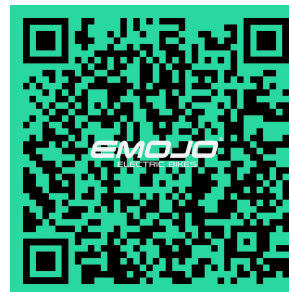

Handlebar adjustment

You can adjust the angle of the handlebar to better fit your riding style and position

Simply use an allen key to loosen the bolt on the right hand side, tilt the handlebar up or down to match your riding position preferences. There is an angle indicator scale that could assist you set the desired handlebar position. Once the handlebar is set to the desired position, tighten firmly the allen bolt.



Electric Bike FAQs

Q. How long does it take to fully charge the battery?

A. Depends on the state of discharge but around 4-5 hours if completely discharged.

Q. What are the running costs for an EMOJO electric bike?

A. You will have no worries about rising fuel prices at the pumps. All our electrically powered vehicles use household electricity. The average cost per full charge is about 10 cents per charge. If you charge the battery every single day for a year, it would cost you about \$35 per year.

Q. Can I ride up hills and against strong headwinds on my electric bike?

A. Yes. One of the main advantages of cycling on an electric bicycle is that it literally flattens hills and increases your average speed when tackling inclines and headwinds. If you provide a reasonable amount of effort, you should be able to tackle anything from a 1 in 10 (10%) gradient up to a 1 in 7 (14%) gradient. Pedaling along with the motor is strongly advised to avoid overheating of the motor and to extend the battery life.

Q. Do I need a driver's license, insurance or registration?

A. No, you don't. According to Federal law, electric bikes that are under 750 watts are classified as bicycles. For all intents and purposes, it's simply a bicycle that requires very little pedaling to travel 20 MPH (32 Km/H), saving you time and hassle. Check your local state laws for requirements.

Q. Do I need to pedal an electric bike?

A. No, but it helps to prolong battery life. The motor on our bikes is both throttle and pedal assist controlled, allowing you to decide how much power you desire. Have you ever tried to cycle when speeding downhill on your normal bicycle? It's just like that. The motor is propelling you faster than you're cycling so there is pretty much no resistance, it's merely a formality!

Q. What happens if I get a flat tire?

A. The tires on our bikes are the same as conventional bicycles. Simply replace the tube with a tube of the right size and inflate it. No special tires or parts will be needed.

Q. What happens when I use the brakes under powered assistance?

A. All our bikes are equipped with brake levers that have a built-in safety switch that automatically cuts off the motor power under normal braking conditions. This not only ensures a safe un-powered stopping feature, but also protects the motor under braking conditions so that it isn't working against the brakes.

Q. How far will the bike take me?

A. This all depends on a few factors. Cycling with pedal assist along a straight road under normal conditions, the standard battery should last about 65 miles. Cycling up steep hills will obviously take more energy out of the battery and factors such as road surface, wind resistance, weight of the rider and tire pressure will affect your range. The range with throttle only lasts about 20 miles (35 km)

Q. How do I know when the battery is low?

A. The bicycles have easily visible indicators located on the meters that show the amount of juice left. If it is getting low and you don't think you will make it to your destination, you can switch off your motor and keep it just for the difficult bits.

Q. Do I have to wait for the battery to empty before I charge it?

A. No. The batteries we use are Lithium-ion batteries which do not suffer from 'memory effect'. This means that there is no need to discharge a battery completely before you recharge it again. You can partially recharge the battery at any time without reducing its voltage or lifespan. We recommend recharging the battery after every use, regardless of how far you rode.

Q. Can I put a child's trailer?

A. Yes, you can certainly add a trailer to your bike. We suggest contacting your local dealer for approved trailers.

Q. Can I put the electric bike on a bike rack?

A. Yes, just make sure that the bike rack can hold the weight of the bike. We advise taking the battery off to make it easier to lift and to keep the battery safe.

Storage and disposal

Please follow these steps to prolong the life of your EMOJO bike

- 1-Always keep your electric bike protected from the rain, snow, hail, etc. Always store it indoors or in a closed garage.
- 2-Do not leave your electric bike exposed under the direct sunlight for long periods or time
- 3-If rain or snow catches you suddenly while riding your electric bike will be ok but you must find shelter away from the elements, the battery, display and motor are not designed to perform under heavy rain or snow.
- 4-It is highly recommended that you use a damp cloth to clean your electric bike, do not use a water hose nor a pressure washer to wash your bike, electronic components may get damaged. If the tires or parts of the frame are heavily loaded with mud or dirt you can use a wet brush to scrub it away rather than pressure-wash your bike.
- 5-If the battery is damaged or no longer working, dispose it according to the local laws, do not throw away with the regular trash. Consult recycling centers. Batteries are considered electronic waste.
- 6-Do not attempt to open, repair, upgrade, retrofit or refurbish the battery and or the motor, they are not serviceable by the user.

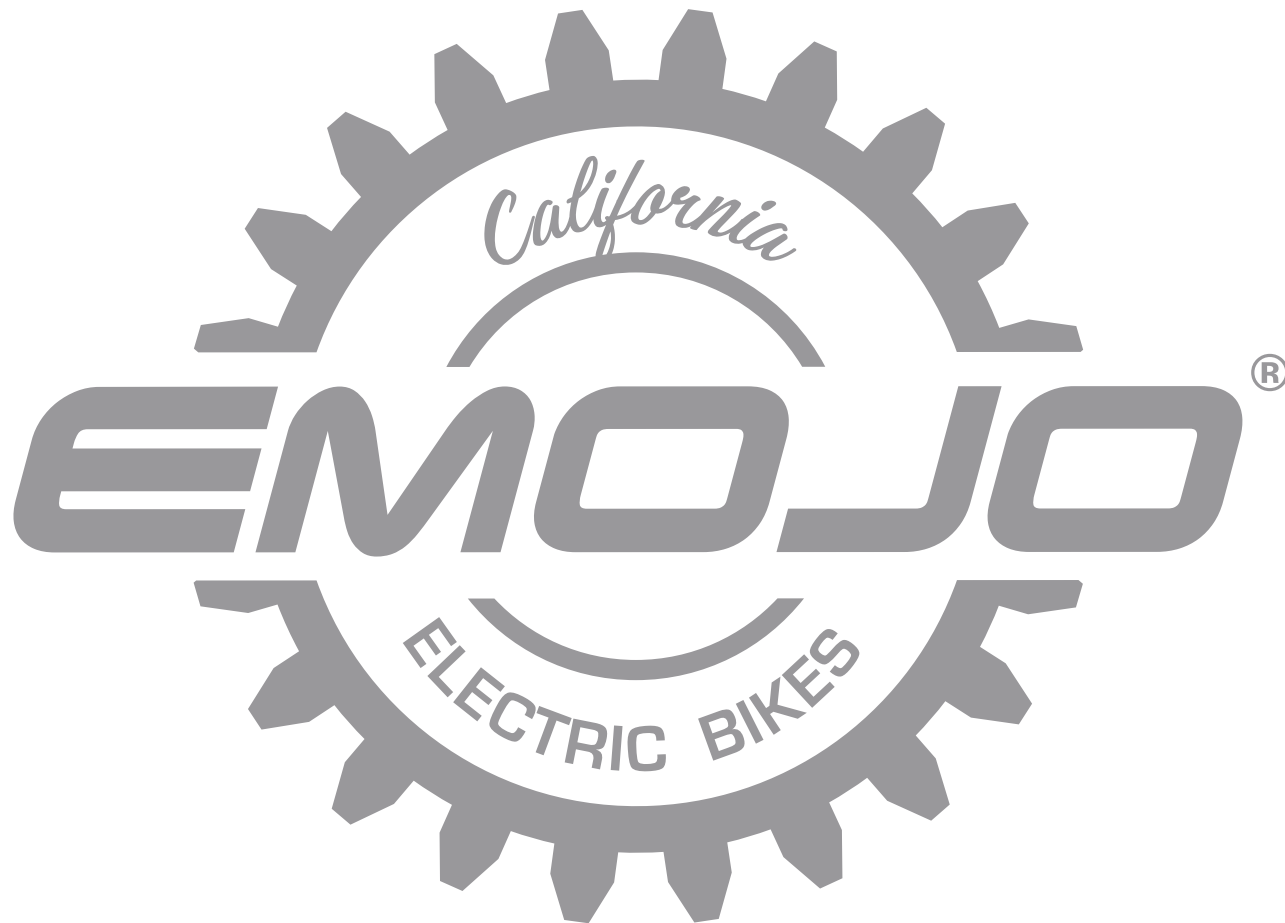

At EMOJO we are committed to the consumers and the experience first, put a smile on the face of each of EMOJO rider and revive childhood memories when riding a bike meant freedom regardless of your age or gender, life doesn't stop and neither should you, that's why we say: "RIDE LIFE"
Should you have any comments, questions or just want to say hi, feel free to throw us an email or give us a call:

 13845 Alton Parkway
Suite B
Irvine, CA 92618 USA

 949.878.1518

 info@emojobike.com
support@emojobike.com

 emojobike.com