

BISON S

OWNER'S MANUAL

CONTENTS

Instructions	1
Warnings	2
Explanatory drawing of the overall bike configuration	3
Schematic diagram of the electric bicycle	4
Main technical parameters	5
Throttle control	6
Gears	7
LCD Control keys	8
Operation stages	9
P.A.S. Control	10-11
Error codes	12
Charging your battery	13
Battery mounting and removal	14
Front wheel installation and seat adjustment	15
Brakes	16
Pedals and tire adjustment	17
Chain	18
Common faults and maintenance	19
Power shut off troubleshooting	20
Folding mechanism	21
FAQ	22
Register your trike/storage and disposal	23
Contact us	24

Instructions

1. Please read the manual carefully before using the electric trike.
2. Make sure all parts are locked tightly, such as the frame joint, driver hand pipe, seat post and pedal, etc. before using. Do not use electric trike before carefully reading the instructions and knowing about the performance of the electric bicycle. Do not lend the electric bicycle to anyone who does not know how to operate it.
3. Develop a habit of charging when the power of the battery pack shows a red light. Please charge and maintain the battery pack consistently to have longer service; if the bicycle is not to be used for a long period, it is suggested that one must close the power of battery pack, and charge-discharge the battery once per month.
4. Frequent braking, starting, uphill, luff, still starting, muddy and uneven ground, overloading of people and goods will assume larger electricity, thus influencing the travel mileage. If you want to get the best travel mileage, we suggest you follow the following instructions:
Ride the bicycle to a certain speed by pedaling, and then turn on the power.
Try to decrease the frequency of braking and starting while maintaining safe riding habits.
Please assist with pedal when the slope angle is steep, or the wind speed is fast.
5. When you lift the battery, please do not insert metal objects (such as lead wire, key etc.) into the charging socket or put them on the positive and negative contact point of battery cell. This can cause the battery to short-circuit, striking fire, and endangering personal safety.
6. This e-bike is not intended to be ridden through water. When the water level inundates the controller, electrical circuitry or motor hub, it is possible that it will cause short circuit and damage the circuit, please pay attention to avoid burning down the electronic control system! **Leave it indoors when charging or not riding.**
7. The standard load weight of this bike is **250 lbs.** (including the cyclist), overloading may cause the travel mileage to decrease, or cause the spare parts of the bike damage and reduce working life of battery.
8. If a charger which is not specially designed by our company is used to charge the battery pack, and spare parts are used that do not match the performance of the bike, should any accident occur, our company is not responsible for it.
9. If you disassemble or refit the bicycle and its spare parts, our company is not responsible for the loss of performance caused by such action, tampering with your bike or trike will void the warranty.
10. Pay attention to the illuminating state while driving at night, ride carefully and prevent accidents.
11. Minors, pregnant women and anyone with inconvenience of hands and legs should not use the electric bicycle.
12. Please check the tightening state of front axle, bottom bracket shell, rear axle, etc. frequently in use.
13. Children younger than 14 should not ride the electric bicycle.

Please pay attention to the following items for your safety:



Warning!



Attention!

!	!
Disassembling and refitting the bicycle may bring hidden safety hazard to your electric bicycle, thus causing danger.	Make sure to check the safety and stability of the brake, saddle, frame, handlebar, wheel, etc. to avoid accidents.
!	!
Downhill speeding should be moderate, please do not use the front brake first when slamming the brakes at high speed to avoid gravity center forward, causing danger.	Avoid hitting uneven, muddy conditions or stairs in case of flat tire, deformation of wheel rim, thus damaging your electric bicycle and causing danger.
!	!
The brakes should not be oiled to avoid causing iffy brake, endangering personal safety.	Do not ride with objects on the handlebar to avoid operational error.
!	!
Please wear raincoat when driving on a rainy day, should not open an umbrella and operate the e-bike with one hand, please follow the traffic rules consciously.	This is a single person e-bike, not meant to be ridden with passengers, always wear a helmet.

Battery Notice! Warning

!	!
Do not keep, approach or store the battery close to fire, and avoid being near flammable, explosive and corrosive gas.	Do not attempt anything that could short-circuit the battery electrodes, which can damage the battery and cause danger.
!	!
Do not disassemble the battery case and tear up the decal on the battery case, the warranty will be voided.	Avoid external force, drop from high elevation, and immerse in water, damaging battery.

Battery Notice! Warning

!	!
Do not tamper or disassemble the charger. Avoid violent bumping or collision.	It is suggested that you charge in a ventilated environment, avoid humidity, and far away from flammable and explosive objects.
!	!
Please keep your hands dry while plugging and pulling the power plug to avoid electric shock.	While charging, there should be no foreign objects on the charger and/or the battery case.
!	!
Keep children away from the battery block and the charging place.	Avoid contact between the conductive objects and the battery poles at the same time to avoid short-circuit and damaging the battery.



Danger
Electric shock risk

WARNING: Risk of fire or electric shock. No user Serviceable Parts

Explanatory drawing of the overall bike configuration

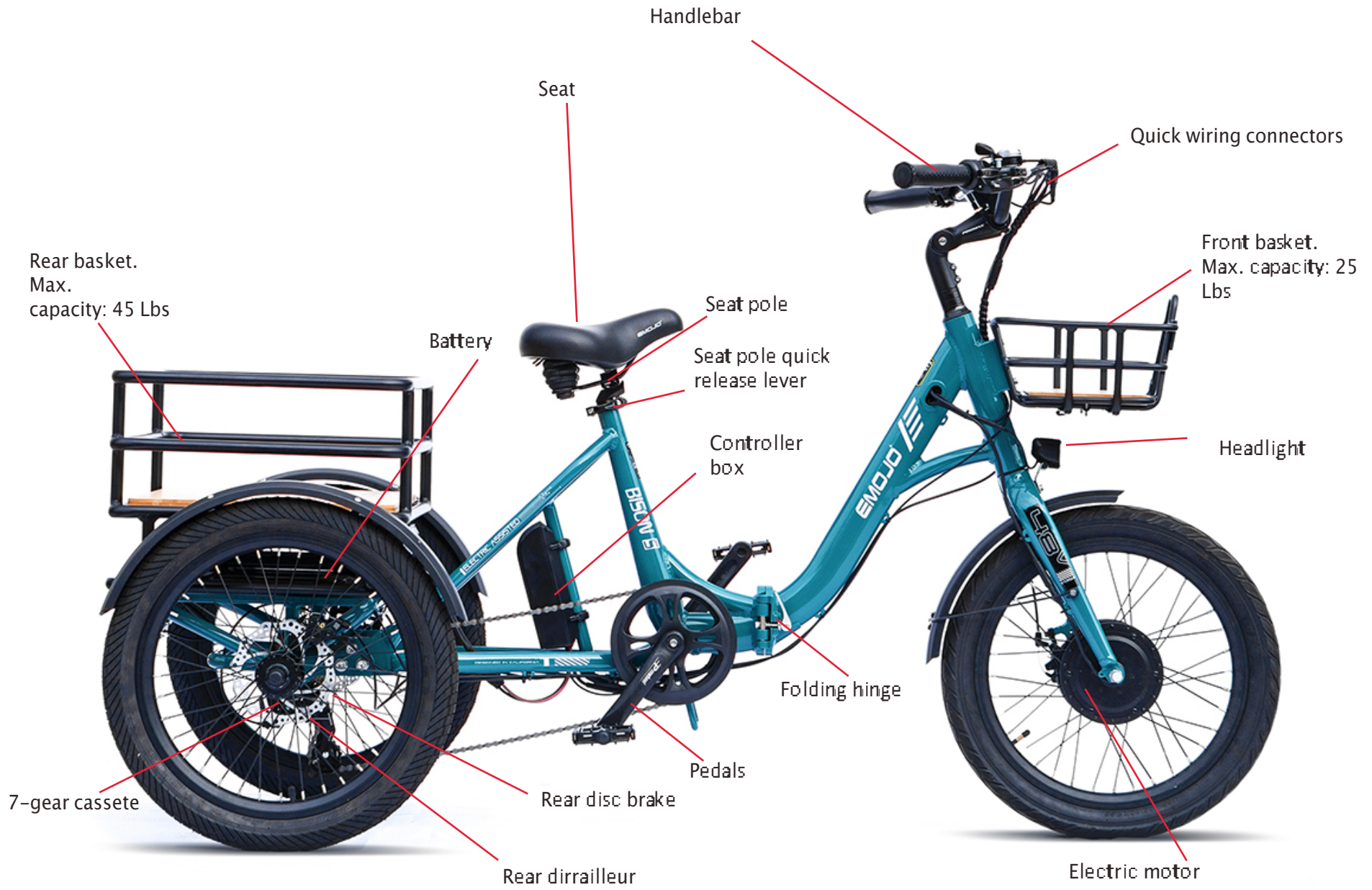

Actual product may slightly differ from this picture

Schematic diagram of the electric bicycle:

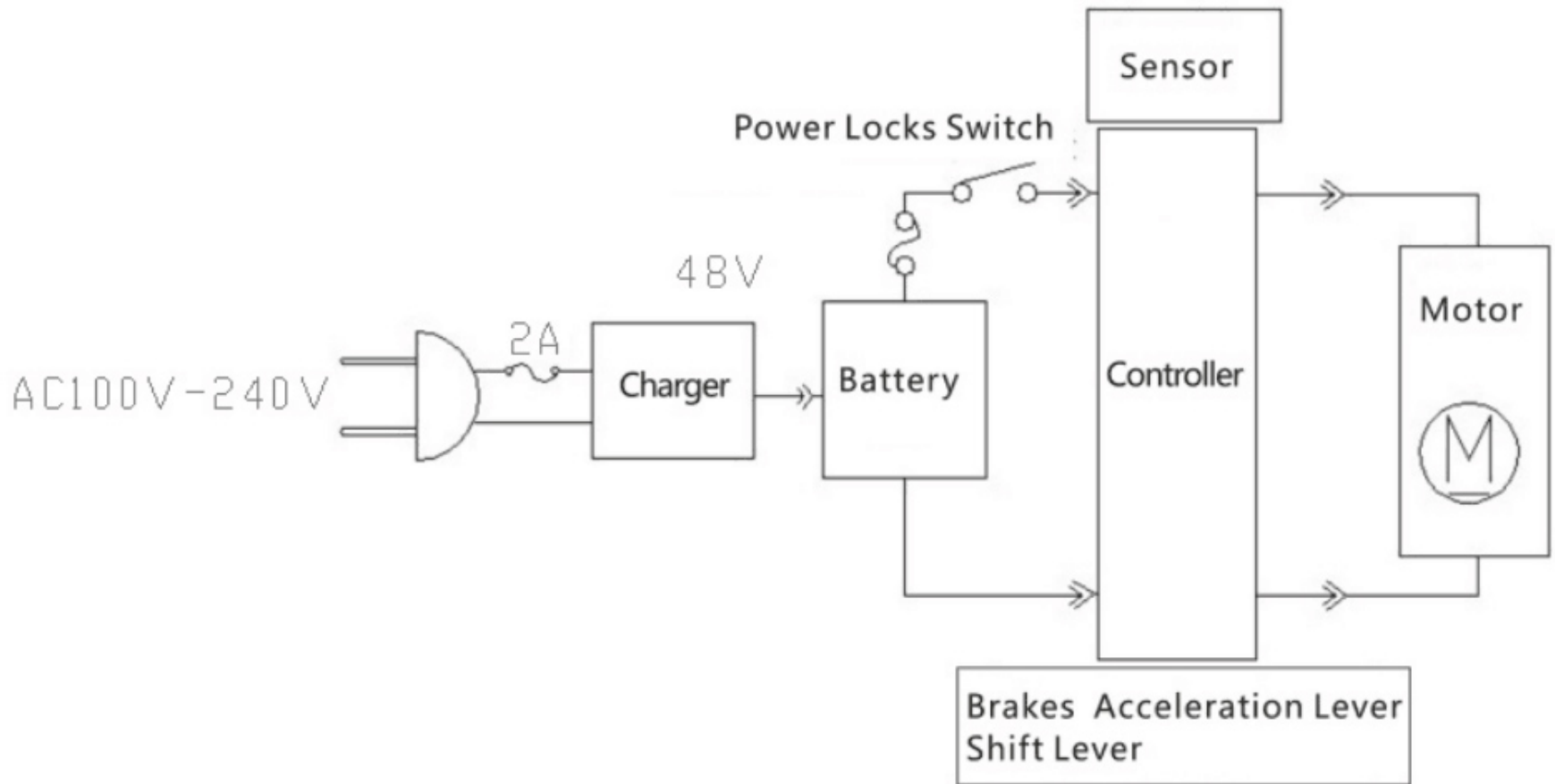

Main Technical Parameters

Item		Index	
Total Weight lbs.		67	
Load weight (including the Weight of Cyclist) lbs.		≤ 250	
Travel Mileage on a single Charge Miles w/pedal assist		Winter ≥ 25	Summer ≥ 40
Power Consumption on a single Charge (kilowatt)		< 0.6	
Power Consumption per Kilometer (kilowatt)		< 1.2	
Battery	Type	Lithium Ion Battery	
	Voltage / Capacity	48V11 Ah	
Motor	Motor Type	Permanent Magnet DC Hi-Speed Motor	
	Rated Output Power	500W	
	Rated Voltage	48V	
Controller	Under-voltage Protection	$40.5V \pm 0.5V$	
	Over-current Protection	$18A \pm 1A$	
Charger	Model	DPLC110V55	
	Duration of Charge	Six to Eight Hours (Instant Charge two to four Hours)	
	Main Appliance Input Voltage	120 Vac 50/60 Hz, 2.0 A	
	Main Appliance Output voltage	54.6 VDC	
	Charging Current	2.0 A	

Ranges of charging service temperature: $0^{\circ} \sim 40^{\circ}C$
 Cycling (discharge) service temperature: $-20^{\circ} \sim 45^{\circ}C$
 Maximum speed limit under pedal assist: 20 MPH

Hand Throttle Control

Your EMOJO electric bike is equipped with a power and throttle control which is fixed on the right hand side. To power on your bike first make sure the switch to your battery is in the ON position.

You adjust the throttle by pushing down with your thumb the paddle, the farther you push from its resting position, the more power is delivered to the motor to accelerate. When you want to slow down, you simply release the throttle and let it return to its resting position and simultaneously apply the brakes.



Thumb Throttle

When the pedal assist mode is set to “0”, the pedal assist function does not engage, however, the throttle continues to work. The throttle control is operated on the right hand side. You control the throttle by pushing it down from its resting position. The farther the throttle switch is from its resting position, the more power is delivered to the motor to accelerate e-bike. When you want to slow down, you simply release the throttle and let it return to its resting position and simultaneously apply the brakes.

Gears

This EMOJO e-bike model is equipped with 7 speeds. The first gear is for easier and uphill pedaling, and the last gear is for maximum speed on level or downhill terrain. Change gears only while pedaling. The rear wheel contains seven chain sprockets. When the chain is around the largest sprocket, you are in 1st gear, or the lowest gear. The high gear will have the derailleur positioned so that the chain is directed around the smallest gear selector should cause a gear change. Adjustments require fine tuning and should only be made by a qualified technician.

Avoid changing gears very rapidly from first gear to the last gear or vice versa. If you change multiple gears too quickly, you could have the chain come off the front sprocket.



Thumb Shifter

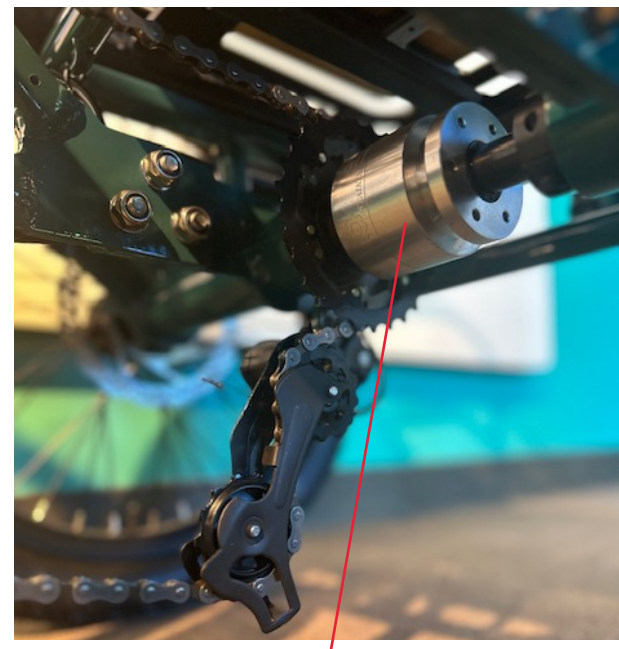

Rear axle differential

LCD Control keys

There are several functions on the screen of your Caddy trike, all of the functions and settings are controlled by the 3 keys on the left side handlebar module.

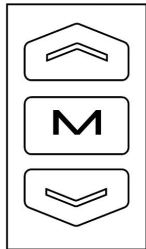

Key control module on the left side of the handlebar

The key operations consists of short press, long press or a combination of 2 keys:

- 1- Short press UP/DOWN keys: Change PAS assist level during riding.
- 2- Short press the M key to switch the information displayed on the multi-function display section
- 3- Long press on a single key is used to toggle between mode/on/off status/Long press on combination of keys to set parameters.
- 4- Long press M + UP arrow to switch speed display type (km/h MPH)
- 5- Long press arrow DOWN when the vehicle is fully stopped to Enable / Disable 6km/h cruise speed limiter
- 6- Long press arrow DOWN when the vehicle is in motion to enter real time cruise control mode. Long press again to exit cruise control mode.
- 7- Long press arrow UP to **turn on/off the lights**.
- 8- Long press the button M on/off the LCD Panel.
- 9- Short press M to switch from readings on the multifunction section

SETTING PARAMETERS

- 10- Long press arrows UP and DOWN simultaneously to enter the menu to customize some parameters such as:
Wheel Diameter (unit: inch); Magnet Steel Number; Back light Brightness; Low Voltage Threshold (refer to setting: P01-P14)
- 11- Short press the M button to navigate between the parameters, use the UP /DOWN arrows to enter the values, they will blink while editable, once set, short press the M button to save. The values will be solid and no longer blink.
- 12- Short press the M button to move to the next customizable parameter
- 13- Short press the UP and DOWN arrows to exit the custom parameter settings.

HEADLIGHT

- 10- To turn the headlight ON, first make sure to turn on your system by pressing and holding the M button for 3 seconds, once the system is on press and hold the UP button until the light turns on, you will see the light icon on the screen appear.
To turn the headlight OFF, press and hold again the UP button.

Correct Operation Stages

! Warning:

For your safety, please practice in open tracts the first time you ride. After mastering the controls of an electric bicycle, you may ride on regular roads and follow the traffic rules consciously. Do not let inexperienced people ride the electric bicycle, do not disassemble and refit the electric bicycle, please pay attention and brake in advance to allow longer braking distance in rainy or snowy weather.

Charge: Charge your battery for the first time for 5 hours, always charge your bike using the provided charger. Never charge your bike outdoors exposed to the weather elements such as rain or storm. The battery nor the charger have user-serviceable parts, do not open, disassemble or modify at any time.

Start: Press the red power button on the battery, then press and hold the M button on the handlebar left controls. You can also check the battery level by pressing the test button on it.

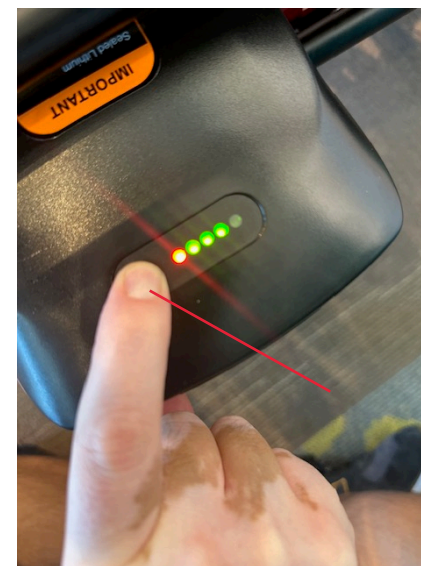

Motor On/Pedal Assist

Click the M button on the handlebar control for 2 seconds to turn on the system, start pedaling and the electric bicycle will drive forward normally. If you stop pedaling, the electric motor will stop working, but it will still drive forward a short distance because of inertia.

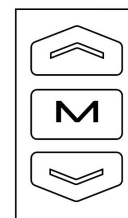

B: Throttle only

You can use the thumb throttle only and the bicycle will move without you having to pedal. Click the M button on the handlebar control to turn on the system, with your right thumb press down the throttle, the further you push the throttle the faster it accelerates. To stop or reduce the speed release the throttle and apply the brakes the electric motor will stop working, but it will still drive forward a short distance because of inertia.

Note: A: For your safety concern, please hold the grip tightly with both hands while riding, and please brake in a timely manner when necessary.

B: This bicycle has the function of brake power cut. The brakes will cut off the motor power to ensure safety of riding. Always check your brakes and cables before riding.

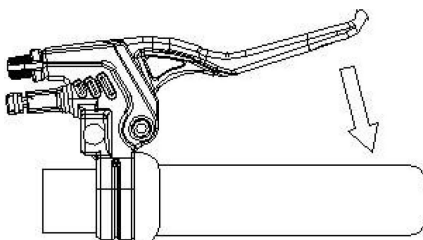

Pull to brake. Brake sensor will shut off motor power.

Pedal Assist Mode Control LCD

Please read the following steps and images to help you understand how to read and operate all the functions.

◆ Display Interface

After switching on the E-bike system, the display shows current speed and total distance except, battery indicator and assistance level

◆ To change the indicated information, press the MODE button to show in turn as follows: Current Speed (Km/h) → Trip Distance (Km) Trip Time (Hour) → Max. Speed (Km/h) → Avg. Speed (Km/h) → Motor-output (W) → Current Speed (Km/h).

◆ Speed limiter: There is a preset setting which allows your bike to cruise at a steady speed of 3.7 MPH (6Km/h), the letter "P" is shown at the screen. To engage this cruise control feature press and hold the "-" button for a few seconds until the letter "P" shows on the screen. To disengage this function press the brakes.

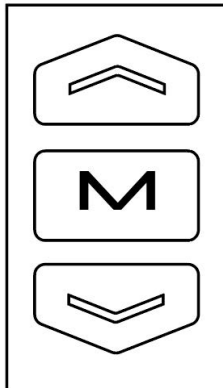

Press the power button (M button) on the LCD screen module located near the left grip on the handlebars to turn it on.

You can adjust the pedal assist power level to have more power by hitting the [up] button (top button) and can move to a lower level power by hitting the [down] button (bottom button).

When not riding your bike, you can turn off the meter by holding down the power button (M button) for several seconds.

◆ Throttle and PAS

When pedal assist (PAS) is set to "0" you will not get any assistance from the motor as you pedal, however, the thumb throttle will work.

◆ To get pedal assistance, change the PAS level to 1 or higher.

◆ The throttle works all the time in all 5 PAS levels, even in level "0"



Pedal Assist Mode LCD Screen

The LCD shows: Speed, Motor Power Ratio Display, Battery Level, Error Indication, Total Mileage, Single trip mileage, Cruise Control, Single Running Time, Light on. To turn the meter on, make sure the battery is fully inserted into the bike and the on/off switch is in the on “On” position.

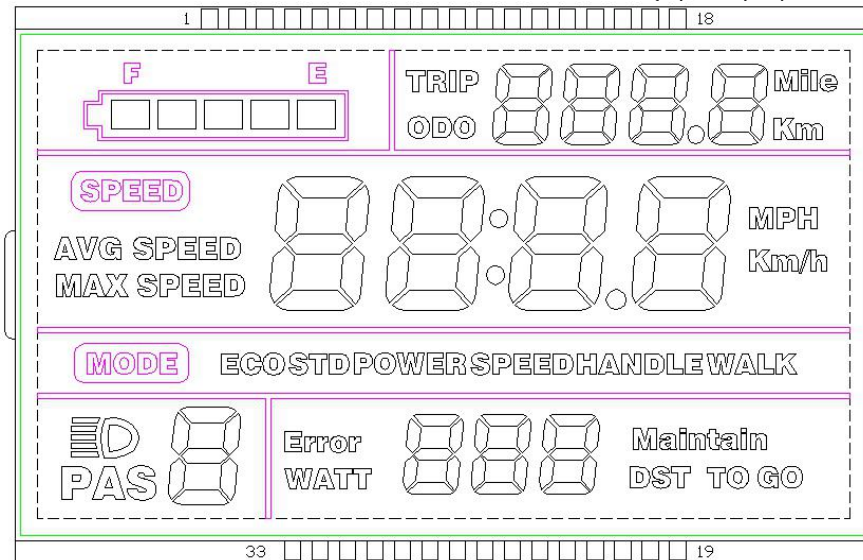

Press the power button (M button) on the two button selector located near the left grip on the handlebars to turn the meter on. You can adjust the pedal assist power level to have more power by hitting the [UP arrow] and can move to a lower level power by hitting the [DOWN arrow] button. When not riding the bike, you can turn off the meter by holding down the power button (M button) for several seconds.

Display functions

1-Power On/Off

Press the M button to power on the display. To power off display and power supply to the bicycle press and hold for 3 seconds

3-Riding Mode

The system has 5 PAS assistance modes, use the UP/DOWN buttons to scroll between modes: Eco, Standard, Power, Speed, Walk and push.

4-Distance Display

Press the M button once to toggle between ODO/TRIP/ERROR CODE/ POWER WATTS/MAINTENANCE INDICATOR/DISTANCE TO GO

5-Riding Time

The riding time will be saved up to 100 hours unless you reset it

6-Battery Level Indicator

Indicates battery level, there are 5 levels, each segment stands for 20% charge

7-Speed Indicator

Shows the speed either in MPH or KM/h. The speed section will show current speed, maximum speed, average speed and measuring unit (MPH or KM/h)

8-PAS Level

Located on the bottom left section, it indicates the level of motor assistance. Use the + - buttons to switch between PAS levels

9-Settings

P01: Back-light Brightness (1: darkest; 3: brightest), P02: Mileage Unit (0: KM; 1: MILE), P03: Voltage Class: 48V (default), P04: Hibernation Time (0: never, other figures refer to the hibernation time) Unit: minute
P05: Power Gear – 0/3 Gear Mode: Gear 1: 2V Gear 2: 3V Gear 3: 4V 1/5, P06: Wheel Diameter Unit: inch (Precision: 0.1)
P07: Magnet Steel Number for Speed Test Range: 1-100, P08: Speed Limit

Error Codes

In the event of a system malfunction the screen will display an error code. You can troubleshoot the problem by identifying the code from the following list:

Display System A

Codes	Indications	Meaning
21	Current abnormality	Low or inconsistent power delivery. Revise battery
22	Throttle problem	Throttle fault, throttle cable disconnected
23	Motor problem	Electric motor fault
24	Motor hall problem	Hall sensor fault, possible motor replacement
25	Brakes	Brake lever sensor fault
30	Display communication	Display fault or disconnected cable.

Display System B

Codes	Indications	Meaning
2	Brakes	Brake lever sensor fault
3	PAS (Pedal assist)	Cadense sensor fault
6	Battery low voltage	Battery might need replacement, is not holding charge
7	Motor problem	Electric motor fault
8	Throttle problem	Throttle fault, throttle cable disconnected
9	Controller problem	Faulty controller
10	Communication receiving	Display fault
11	Communication sending	Display fault
12	BMS communication	Battery management system fault
13	Headlight	Headlight connection problem or faulty lights.

Display System C

Codes	Indications	Meaning
30	Controller problem	Faulty controller
33	Battery low voltage	Battery might need replacement, is not holding charge
34	Throttle problem	Throttle fault, throttle cable disconnected
35	Communication receiving	Motor signal not received
36	Communication sending	Motor signal not sent
37	Brakes	Brake lever sensor fault

Charging the battery

1. Always charge the battery fully for the first time. When the battery level is low plug it to charge it, use only the original charger provided with the battery.

Slide open the protective hatch to access the charging port



2. Insert the charging pin of the charger into the battery charging plug; pay attention to the direction of the pins, do not insert any other foreign objects or dismantle

3. Connect the power plug of charger into a household AC power outlet. Please do not insert the plug into the AC around water or with wet hands, avoid causing electric shock hazards.



4. Please check the charger indicator. When the LED indicator on the charger is red, it indicates the battery is charging, when the indicator is green, it indicates charging completed.



5. After charging completes, please pull out the charger power plug from the household AC and disconnect the plug from the battery

Attention:

1. Make sure the charger is the original charger.
2. All charging plugs must be inserted tightly.
3. The average charging time of the whole battery pack is 6-8 hours, please operate in strict accordance with above instructions and keep charger away from children.
4. Please do not charge under the rain or in wet environments.

Battery mounting and removal

1. Installing the Battery

Insert the battery into the designated area under the rear basket, aligning the battery guide to the power socket on the far end. After hearing a click, the battery is properly installed. Use the provided keys to lock the battery to the frame.



2. Battery removal

Park the electric bicycle, unlock the battery switch until the key cylinder in the battery pack is completely free from the hole on battery case slider, then hold the battery handle and pull out battery pack.

3. Battery care

The battery can be charged while removed from the bicycle/tricycle, however you must charge it indoors and away from high humidity conditions, rain, snow or other weather elements.

4. Battery storage

Keep the battery stored in a cool and dry place, NEVER leave the battery outdoors exposed to the weather elements. Never leave the battery permanently connected to the charger and the electricity.

5. Battery disposal

Dispose the worn out or damaged battery according to your local laws, consult your local laws and or/recycling centers. Do not throw away with the regular trash, the battery is considered electronic waste and must be disposed accordingly.



Battery lock switch

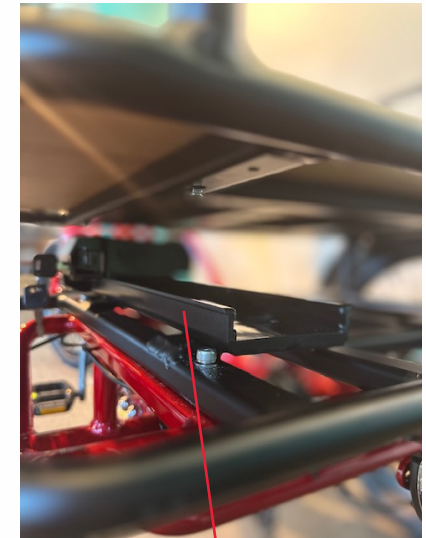

Battery rail



Note: While installing and removing, do not use extreme force to avoid damaging the battery pack and other components.

Front wheel installation

Read the instructions carefully to identify and understand the components of the electric bicycle such as pedal, seat post etc. and the name of relevant spare parts. When specialized servicing of bike is required, please go to an authorized EMOJO repair shop or store or another trusted bike professional.

1. Assembly of the front wheel unit:

Identify the nuts and washers necessary for the front axle assembly.

Assemble the front wheel unit onto the front fork, add the washers on the front axle and the nuts (Fig A), tighten them on both sides and put the protective caps (figs. B and C). Attention: when assembling, make sure the disc brake and the brake caliper are on the same side (left side), the disc brake must slide into the gap between the two brake pads of the disc brake caliper, make sure the wheel turns freely and does not rub against the brake pads when the front brake is not been pressed.



Fig A.



Fig B.



Fig C.

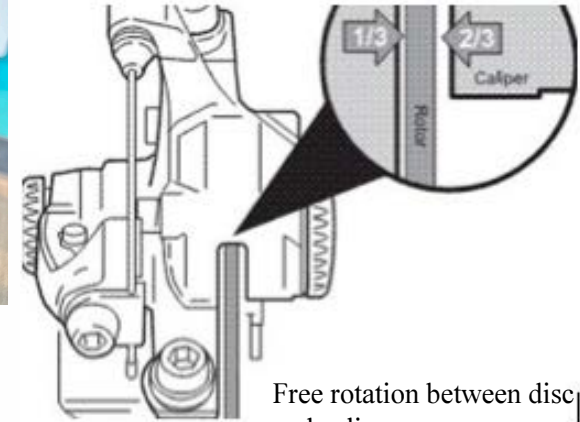

Free rotation between disc
and caliper.

2. Adjustment of Saddle:

Adjust the saddle to the proper height. Using the socket hand wrench, lock the fixed screws on the seat post and clamp tightly. Please note that when adjusting the height of the standpipe and seat post, it has to keep the inserting depth above the safety line.

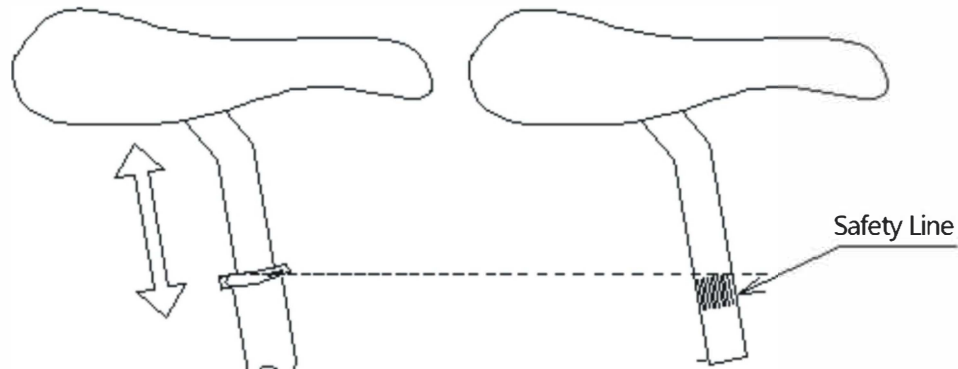

Disc Brakes



Your EMOJO e-bike is equipped with disc brakes for maximum reliability. Applying hand pressure to the brake levers will engage the brake pads against the brake rotor, creating friction and slowing down the wheel. The more hand pressure applied to the brake lever, the faster the bike will come to a stop.

Check the front disc handle gap by depressing the brake lever about 10 times to check that everything is operating correctly (Fig. 1) If necessary you can adjust the brake by turning the dial on cable (shown with a red arrow). Your front wheel must spin free at all times without any friction from the brake when not applied.

The rear brake should always be applied before or along with the front brake. Applying only the front brake to slow or stop at high speeds may result in the rider being ejected from the saddle and continuing forward over the handlebars. It is best to apply even pressure to both brake levers when slowing or stopping.

Bicycles equipped with disc brakes will occasionally make a slight scraping noise when the wheels are turning without the brakes being applied. This is normal.

Make sure that the brake lever does not contact the handlebar when full hand pressure is applied (b) The contact point should feel firm and solid. If the lever travels all the way to the handlebar or feels spongy, they may require service by a qualified bicycle technician.

If the brakes are still not operating correctly, they may require further adjustment by an experienced bicycle mechanic.

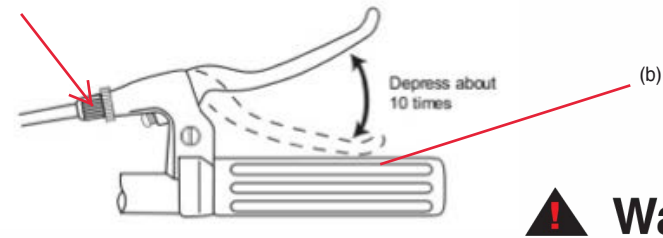

Figure 1

Warning!

Attention!

WARNING:

- Disc brake rotors become hot during use. Do not touch or come in contact with the disc rotor shortly after use.
- Wet weather will require a longer distance to stop. Brake earlier and avoid sudden stops when riding in wet conditions.

New Brakes Bed-in Procedure

New brakes will require a “bed-in” procedure prior to your first ride which will ensure the most consistent and powerful braking feel.

- 1 Find a safe riding area that will allow for moderate speed. Remain seated during the entire procedure for optimal results.

Important Note: Do not lock up the wheels at any point during the bed-in procedure.

- 2 Accelerate the bike to a moderate speed, then firmly squeeze the brake levers until you are at walking speed. Repeat this process about twenty times.

Accelerate the bike to a faster speed, then firmly squeeze the brake levers until you are at walking speed. Repeat this process about ten times.

Allow the brakes to cool down before your first ride.

4. Pedal Installation and Adjustment:

Take out pedals from the accessory box, install one of the pedals (pedals are marked with the letters “L” and “R” to indicate the side they belong to). When installing the pedals, insert the wrench stuck on the flat end of pedal axial head, and twist into the crank in clockwise direction.

5. Check and Adjustment of Tire Pressure

Keep proper air pressure, the space between tire and ground contact is about 4 inches long when riding on the electric bicycle.

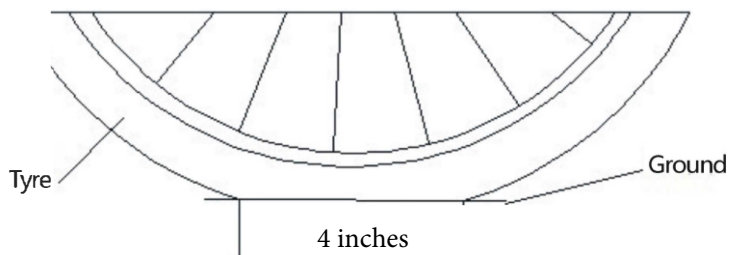

Tire size: 20 x 2.5

Tube size: 20 x 2.5

Minimum tire pressure :40 PSI, maximum tire pressure: 65 PSI



Important

Check the tire pressure before riding, inflate as necessary as per given parameter.

6. Brake Adjustment

A. When brake lever reaches 1/3 of unstressed state, the power will be cut out completely, when it is at 1/2, bike can brake completely.

B. The distance between brake pad of front wheel and rim should not be more than 2mm, when the brake pads wear down, timely adjustment is possible, after adjustment, the brake pad should not interfere with other spare parts. When a worn brake pad reaches 1/2 of its thickness, it must be replaced.

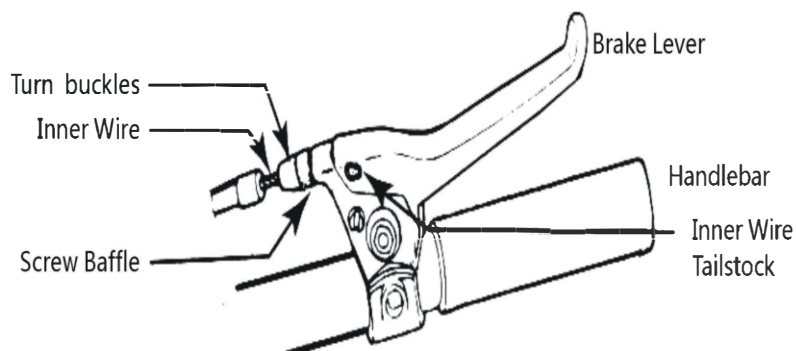

7. Adjustment of Power Assisting Hall Sensor

A: Turn the bike upside down, have it rest on the floor.

! The distance between the sensor and the disk shall be 3-5 millimeters

: Installing the sensor on the side of chain ring, when forwarding the chain ring, the power assistance is effective.

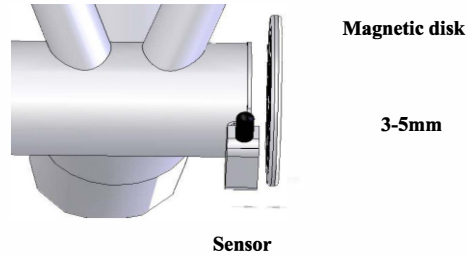

8. The Adjustment of Chain Tension The chain can sag with use, make sure your chain is properly adjusted. A sagging or overtightened chain could cause damage to the motor. To manually check the tension of the chain, push up the bottom section of the chain with the hand, the range of the tension should be within 10mm from horizontal line.

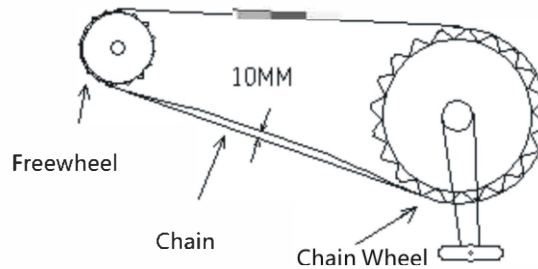

Common Faults and Maintenance

Common Faults	Troubleshooting
Power on, there is no indicator on meter: Push thumb throttle, the motor does not work:	Check the battery power, if battery is low, it is possible that the power will fail, or some blown fuses of the controller are burned out.
	Check whether the speed controlling wire of left brake levers fail, and whether the connector of the controller or motor fails.
Motor kicks in, but speed is low	Check whether the brake is locked, the tightness of chain is proper; the air pressure of tire is proper; check whether the battery power is full, if not, please charge the battery.
Short Mileage	If the battery has not been in use for a long time, please recharge the battery in advance. Check whether the brake rubs against the rim because of tightness, and whether the tire pressure is full. Check whether the battery is full, if not, please recharge it.
Abnormal Noise of the Bike	Check for all screws and bolts to be properly tightened.

Battery Not Charging	Check the charger and power. Check whether the battery connection is in good condition and is stable. Check whether the charger plugs board fails. Check for any blown fuses in the battery case or any disconnected wiring.
----------------------	--

Note: if you experience problems contact your retailer, dealer or the manufacturer.

Regular Maintenance Table

I: Inspection A. Adjust R: Replace L: Lubrication T: Tight lock			
Items to be Inspected	60 days	180 days	360 days
1.If the steering of handlebar loosens or wears down	A, T	I, L2	I, L2
2.If pedal, axis loosens or wears down	T	I, L1	I, L1
3.If the tire inflation is proper and the cover tire wears down		I	R
4.If anterior- posterior axis shift, axis bowl, hub spindle looses or wears down	T	I, L2	I, L2
5.If middle axis bowl, hub spindle, axle cap loosens or wears down	A, L1	A, L1	I, L1
6.If the chain is loose	A, L2	A, L2	I, L2
7.If the brake shoe wears down		R	R
8.If the wheel rim deflects or deforms		I	I
9.If the frame and front fork deform or are damaged		I	I
10. If spokes break down or becomes loose		I	I
11. If the brake operates smoothly	I	I	I
12. If brake lever is at its proper position	A	A	A
13. If the reflector is dirty or damaged		I	I
14. If the front light is bright		I	I
15. If the charger plug and power line wears down or breaks off			I
16. If the height of saddle and handlebar is proper	A	A	A
17. All screws positions are tight	I	I, T	T

**Note: L1- recommends using No.68 HL hydraulic Lubricant
L2- recommends using No2. Calcium-based Grease.**

Power shut off troubleshooting

If your EMOJO trike experiences a sudden power shut off while in use, this can be related to several reasons but the problem has an easy fix.

PROBLEM

The LED module on the handlebar starts to blink repeatedly followed by a power shut off. (Make sure the battery is not depleted)

2-Check the power quick disconnect plug on the right side of the front fork and the quick disconnect plug by the battery

Quick Disconnect (next to the battery)



Quick Disconnect (front fork right side)



⚠ Warning! ⚠ Attention!

The controller box is a component that shall NOT be dismantled by the user. It does not have any user-serviceable parts. Diagnostics, repairs or replacements must be performed by a technician only.

If the battery is not depleted and the quick connector cable is all in place, contact your shop or EMOJO tech support at support@emojobike.com.



Folding mechanism

Your electric trike has a folding mechanism that allows it to be folded in half to save space for transport or storage.

1-On the right hand side, locate the locking/unlocking lever



2-Unlock the lever and move to the right, lift while holding the front of the bike and fold.

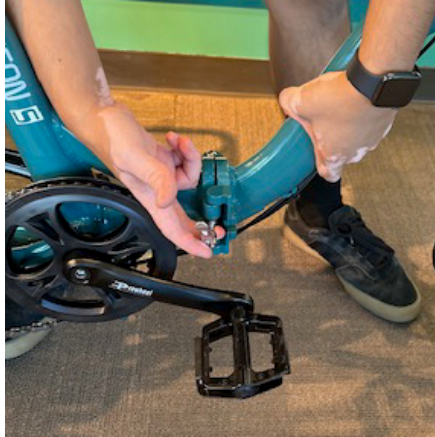

3-Fold the frame gradually in half

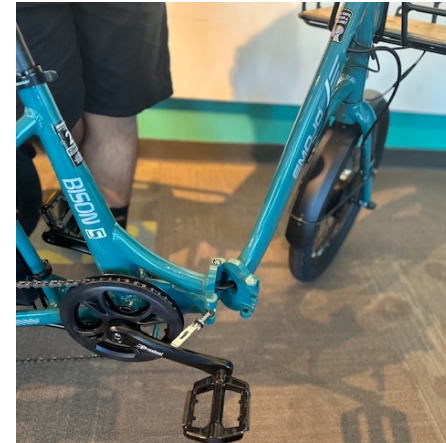

Fold out the front section of the frame moving it as close as possible to the rear wheel.

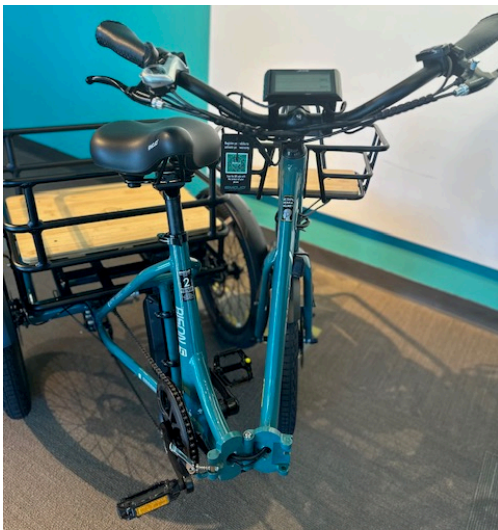

Invert-repeat these steps to unfold and lock the ebike to its original shape.

 **Warning!**

Be careful not to pinch your hands when unfolding and locking the ebike.

Always make sure the folding mechanism is properly secured and locked before riding.

Electric Bike FAQs

Q. How long does it take to fully charge the battery?

A. Depends on the state of discharge but around 4-5 hours if completely discharged.

Q. What are the running costs for an EMOJO electric trike?

A. You will have no worries about rising fuel prices at the pumps. All our electrically powered vehicles use household electricity. The average cost per full charge is about 10 cents per charge. If you charge the battery every single day for a year, it would cost you about \$35 per year.

Q. Can I ride up hills and against strong headwinds on my EMOJO electric trike?

A. Yes. One of the main advantages of cycling on an EMOJO electric bicycle is that it literally flattens hills and increases your average speed when tackling inclines and headwinds. If you provide a reasonable amount of effort, you should be able to tackle anything from a 1 in 10 (10%) gradient up to a 1 in 7 (14%) gradient. Pedaling along with the motor is strongly advised to avoid overheating of the motor and to extend the battery life.

Q. Do I need a driver's license, insurance or registration?

A. No, you don't. According to Federal law, electric bikes that are under 750 watts are classified as bicycles. For all intents and purposes, it's simply a bicycle that requires very little pedaling to travel 20 MPH (32 Km/H), saving you time and hassle. Check your local state laws for requirements.

Q. Do I need to pedal an electric trike?

A. No, but it helps to prolong battery life. The motor on our bikes is both throttle and pedal assist controlled, allowing you to decide how much power you desire. Have you ever tried to cycle when speeding downhill on your normal bicycle? It's just like that. The motor is propelling you faster than you're cycling so there is pretty much no resistance, it's merely a formality!

Q. What happens if I get a flat tire?

A. The tires on our bikes are the same as conventional bicycles. Simply replace the tube with a tube of the right size and inflate it. No special tires or parts will be needed.

Q. What happens when I use the brakes under powered assistance?

A. All our bikes are equipped with brake levers that have a built-in safety switch that automatically cuts off the motor power under normal braking conditions. This not only ensures a safe unpowered stopping feature, but also protects the motor under braking conditions so that it isn't working against the brakes.

Q. How far will the trike take me?

A. This all depends on a few factors. Cycling with pedal assist along a straight road under normal conditions, the standard battery should last about 31 miles (50 kilometers). Cycling up steep hills will obviously take more energy out of the battery and factors such as road surface, wind resistance, weight of the rider and tire pressure will affect your range. The range with throttle only lasts about 20 miles (35 km)

Q. How do I know when the battery is low?

A. The bicycles have easily visible indicators located on the meters that show the amount of juice left. If it is getting low and you don't think you will make it to your destination, you can switch off your motor and keep it just for the difficult bits.

Q. Do I have to wait for the battery to empty before I charge it?

A. No. The batteries we use are Lithium-ion batteries which do not suffer from 'memory effect'. This means that there is no need to discharge a battery completely before you recharge it again. You can partially recharge the battery at any time without reducing its voltage or lifespan. We recommend recharging the battery after every use, regardless of how far you rode.

Q. Can I put a child's trailer?

A. Not all EMOJO models will be suitable to install a trailer or a child seat. We suggest contacting your local dealer for approved trailers.

Q. Can I put the electric bike on a bike rack?

A. The trike will not fit in any traditional bicycle carrier, there might be other options such a carrier for electric wheel chairs, consult with a carrier manufacturer for options. EMOJO also offers a hitch rack for its trikes.

Register your trike

To activate your warranty please register your electric trike online.

You can scan with your phone this QR code and fill in the information, it takes 2 minutes!



Storage and disposal

Please follow these steps to prolong the life of your EMOJO bike

- 1-Always keep your electric trike protected from the rain, snow, hail, etc. Always store it indoors or in a closed garage.
- 2-Do not leave your electric trike exposed under the direct sunlight for long periods or time
- 3-If rain or snow catches you suddenly while riding your electric trike will be ok but you must find shelter away from the elements, the battery, display and motor are not designed to perform under heavy rain or snow.
- 4-It is highly recommended that you use a damp cloth to clean your electric trike, do not use a water hose nor a pressure washer to wash your bike, electronic components may get damaged. If the tires or parts of the frame are heavily loaded with mud or dirt you can use a wet brush to scrub it away rather than pressure-wash your trike.
- 5-If the battery is damaged or no longer working, dispose it according to the local laws, do not throw away with the regular trash. Consult recycling centers. Batteries are considered electronic waste.
- 6-Do not attempt to open, repair, upgrade, retrofit or refurbish the battery and or the motor, they are not serviceable by the user.

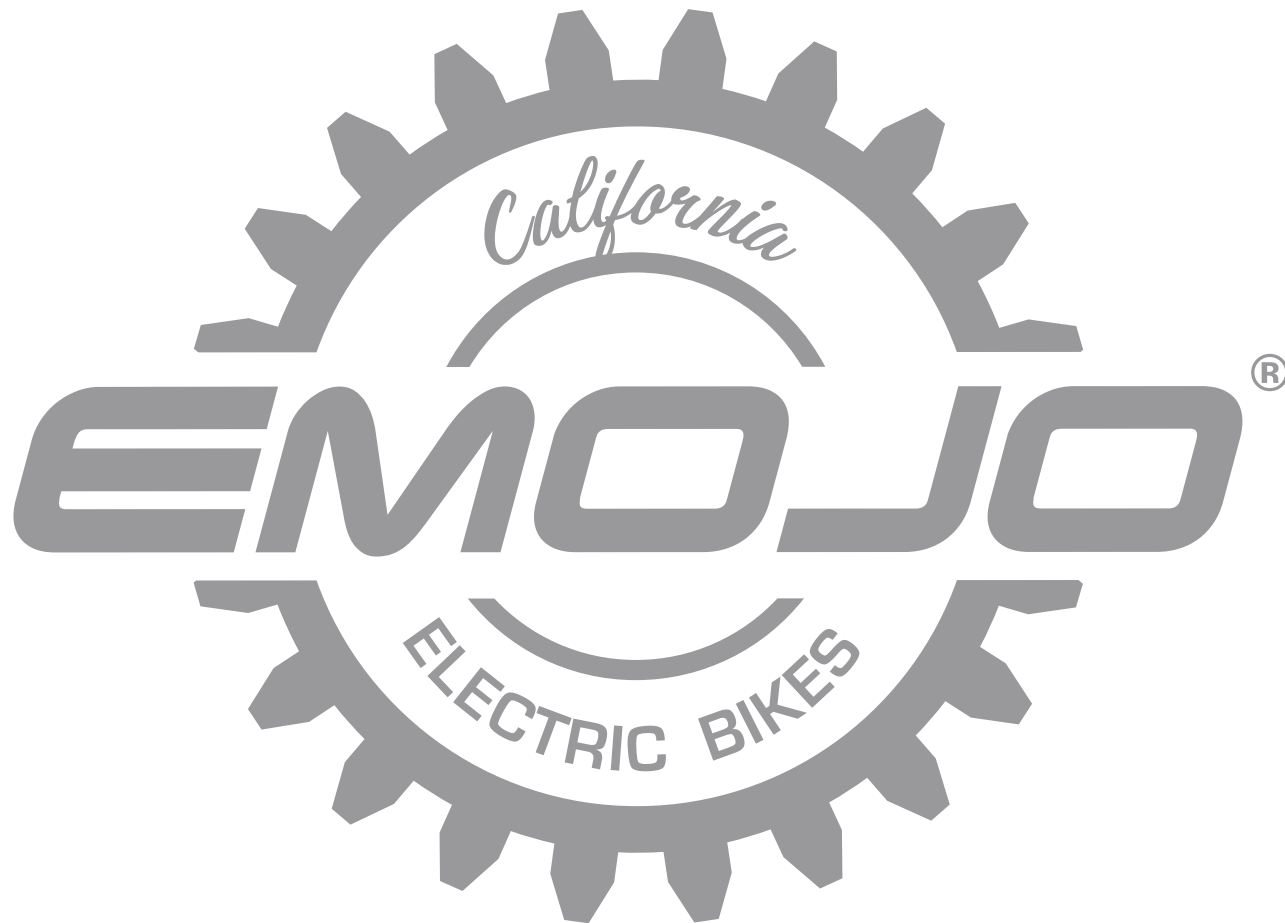

At EMOJO we are committed to the consumers and the experience first and foremost, we strive to put a smile on the face of each of EMOJO rider and revive childhood memories. Riding a bike means freedom regardless of your age or gender, life doesn't stop and neither should you, that's why we say: "RIDE LIFE"
Should you have any comments, questions or just want to say hi, feel free to throw us an email or give us a call:



13845 Alton Pkwy.
Suite B
Irvine, CA 92618 USA



949.878.1518



info@emojobike.com
support@emojobike.com



emojobike.com