

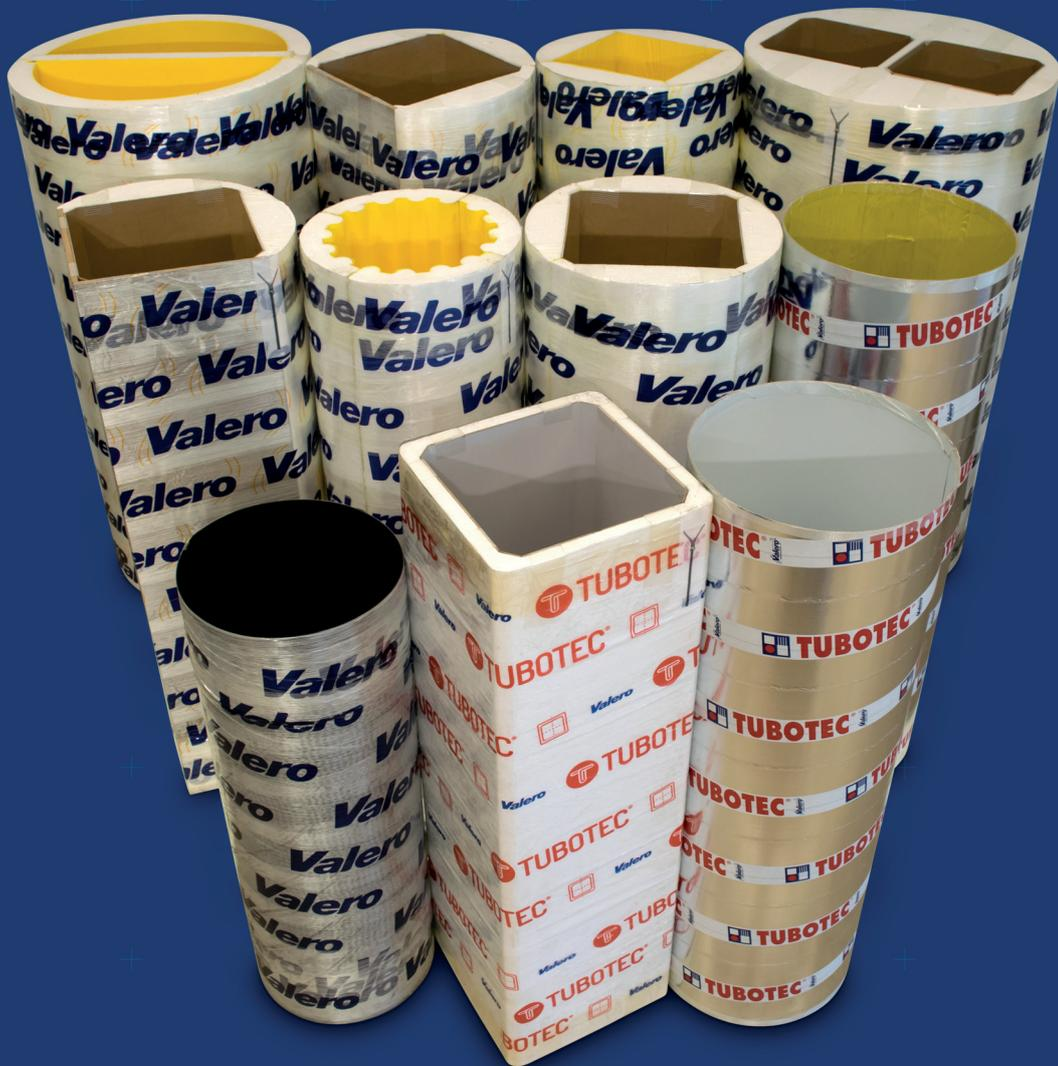

FORMWORK INSTALLATION MANUAL



FORMWORK INSTALLATION MANUAL

1. STORAGE

Do not expose the formwork to the sun or rain (it is recommended to cover them with plastic). Vertical storage is recommended. In case of horizontal storage, do not place any weight on top of the formwork to avoid deformities.

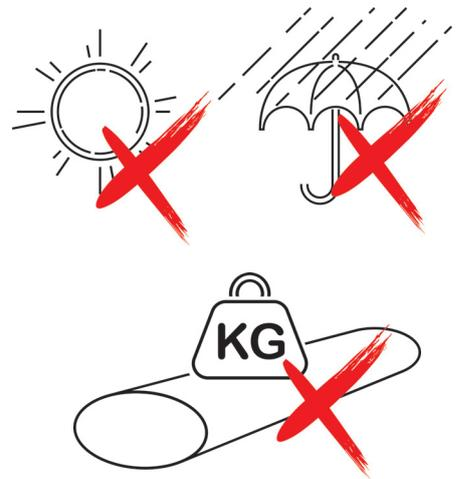

2. SETTING IN SITE

For formwork in which the section of the pillar is different to the outer section of the formwork. The formwork will have red marks to keep a reference of the inferior layout with both sharp and chamfered edges.



When setting out the pillar, mark the square section first on the ground. Then, mark the screenings of the pillar faces on the formwork and matched to the wrought marks.

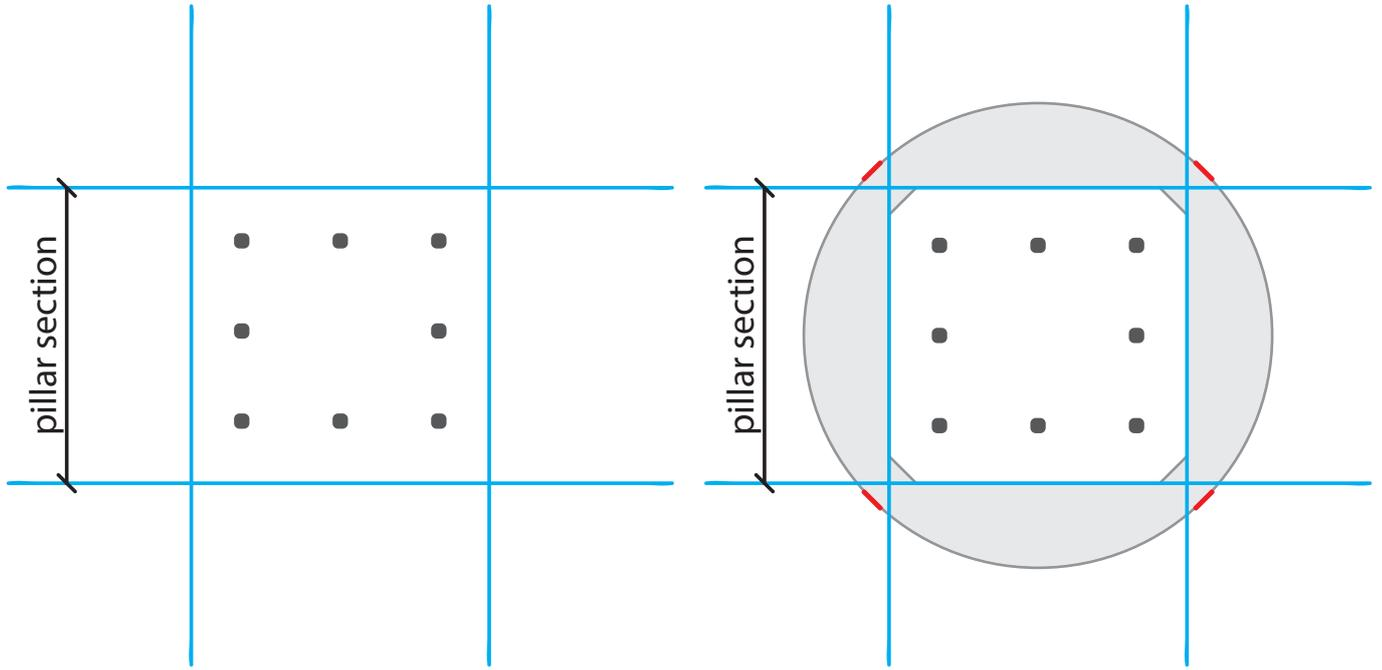

2.1 TUBOTEC Cuadrado [funda]

Mark the pillar section. Then mark the section of the Tubotec Funda, which will increase the size of the pillar faces by 5 cm.

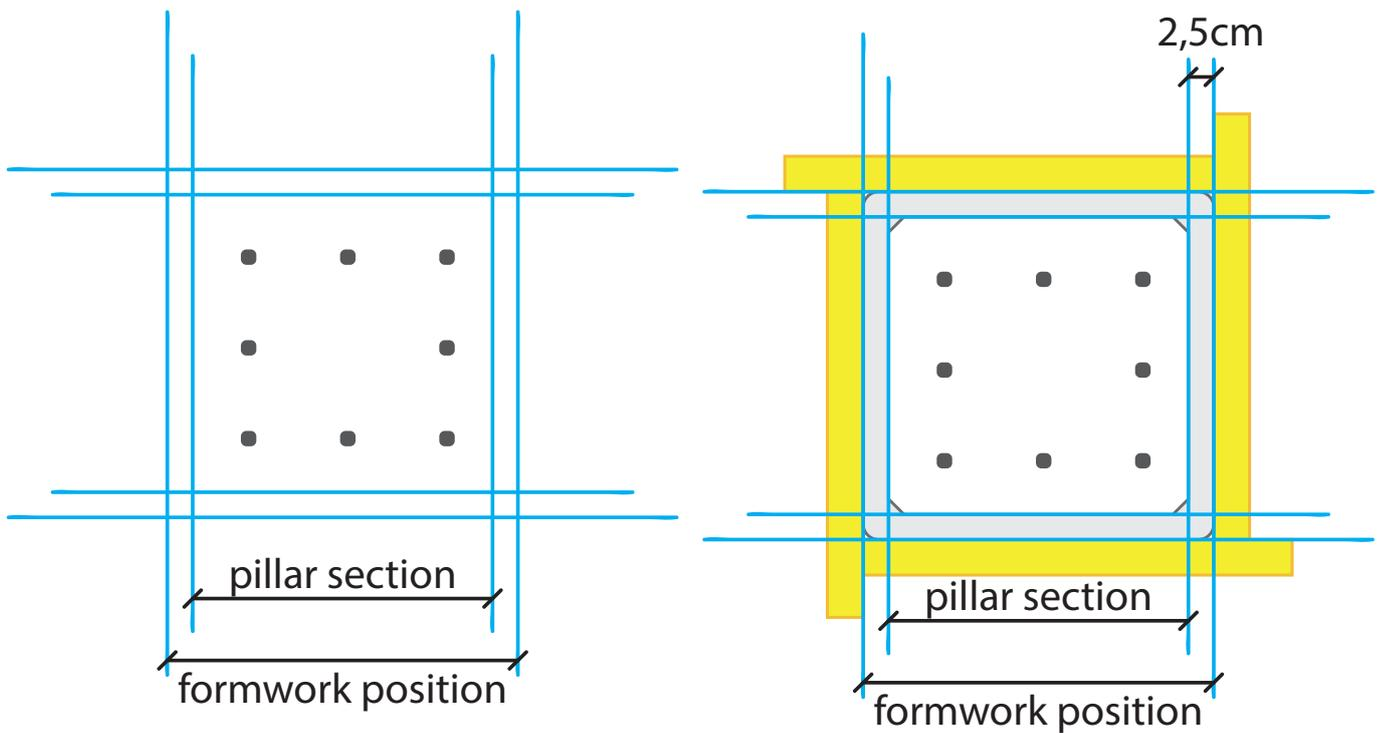

3. FORMWORK INSTALLATION

To facilitate the insertion of the formwork, circular spacers (such as Ruver) should be placed on the steel bars, which will prevent damage to the faces of the formwork, by possible chafing of the frame. It is recommended to use 3 spacers per side for circular section columns and 4 spacers per side for square section columns (1 per side).

CIRCULAR SECTION PILLARS

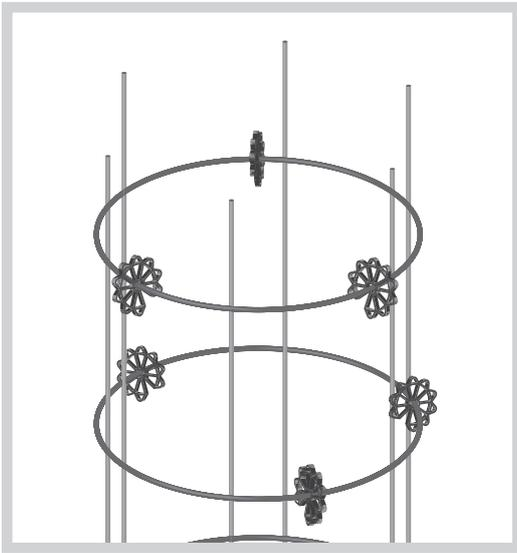

RUVER TYPE SPACER

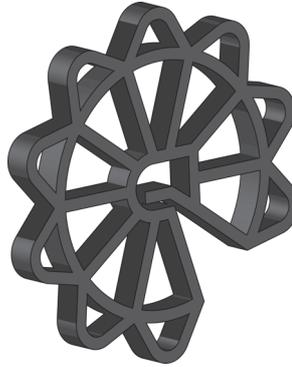

SQUARE SECTION PILLARS

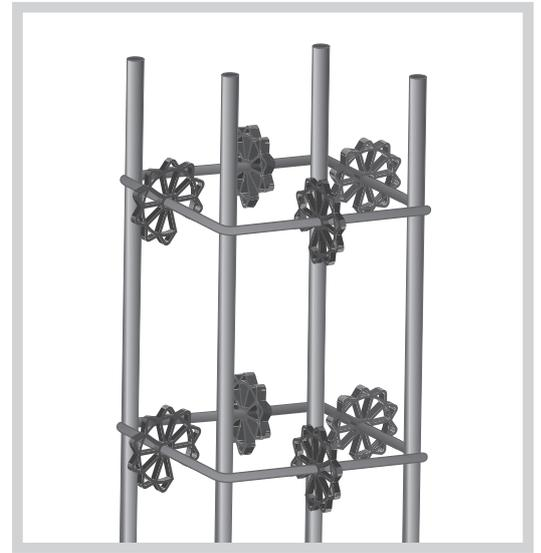

4. FORMWORK INSERTION

When lifting the formwork, it should be supported with a sling around its body, at a minimum distance of 1 m from the top.

As an alternative, there is another method to lift the formwork. Insert a through element in the top to hook it to the crane. For this, it should be taken into account that the concreting of the pillar will not reach the top of the formwork. Otherwise, an overdimensioning of the formwork would be expected.

These methods are suitable for both self-supporting formwork and non-self-supporting formwork.



SELF SUPPORTING FORMWORK

1st. Insert the formwork, adjusting it to the spacers of the steel bars. special care should be taken in this step to avoid chafing the inside of the formwork with the steel bars.

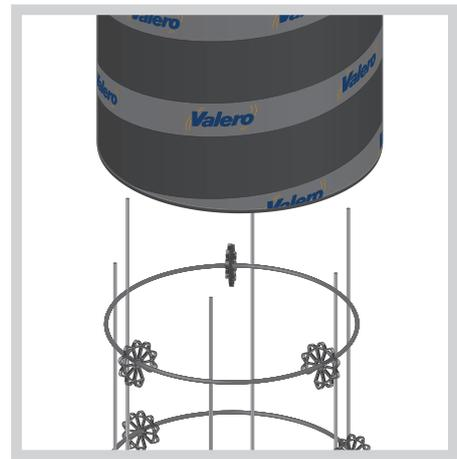

NON-SELF-SUPPORTING FORMWORK

1st. Mount the plates of the formwork (the use of continuous sheets is recommended) with the dimension of the column + sheathing (5 cm more per side).

2nd. Insert and leave the metallic panels opened to insert the Tubotec Funda without deterioration.

3rd. Insert the Tubotec Funda, adjusting it to the spacers of the steel bars. special care should be taken in this step to chafing the inside of the cover with the steel bars.

4th. When Tubotec Funda is in place, the metallic panels must be closed.



4.1. HEIGHTS ABOVE THE MAXIMUM

It is advisable to adjust to the maximum manufacture heights to obtain continuous and completely tight formworks.

If, in exceptional circumstances, a formwork needs to be placed after another to obtain greater height, it is recommended that the pillar concreting is carried out in two steps. Once the bottom part of the column is finished, remove a portion (20 cm approx.) of the formwork leaving part of the pillar visible. It is essential for the operator to make the cut as perfect as possible.

This part of the column will serve to anchor the upper formwork, achieving the closest possible union between the two pillars.

After placement, plumb and tape the joint between the two formworks to lose as little grout as possible.



5. SHORING AND ALIGNMENT

It is important that the base of the formwork is securely mounted to avoid displacements with respect to the setting out. It is recommended to use wooden slats or other auxiliary elements anchored to the ground, ensuring support and stability during concreting operations.



Based on the height, the section, the type of formwork and the experience of the operator, several systems can be used:

- Ecoplom: system made up of metal parts connected with a belt, designed to facilitate the support of props. Place approximately 1 m from the top and the second group, if necessary, at approximately half the height of the formwork.

Table 1. Distribution of struts based on the diameter and height of the formwork

Exterior diameter (mm)	Height (m)	No. PROPS (units)
< 350	3-4	3
> 350 < 650	3-4	4
>650	3-4	5
<350<650	5	Two PROPS groups
>650	>5	Scaffolds or metal sheets



- Timbers: system made up of wooden planks connected with tape or wire, where the struts are supported. same frame heights and no. of props (see Table 1).

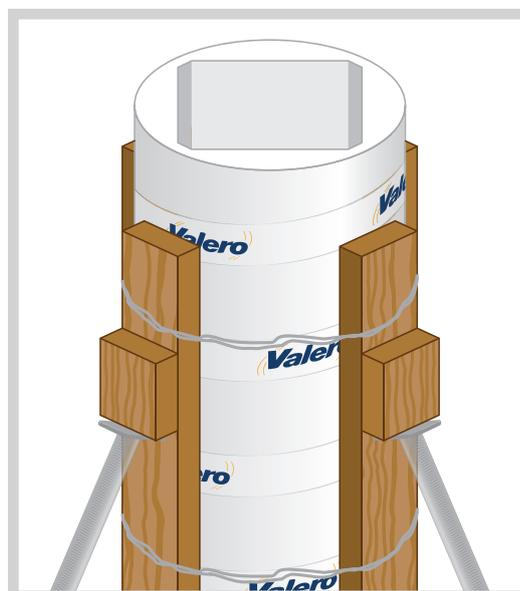

- For large sections, diameters and heights, shore with scaffolds.



- In the case of Reltec Medianero and Esquinero, the flat faces should be completed supported in the adjacent surface. If this is not possible, avoid using point spacers. The formwork will be supported in a linear manner to avoid defects from the concrete pressure.

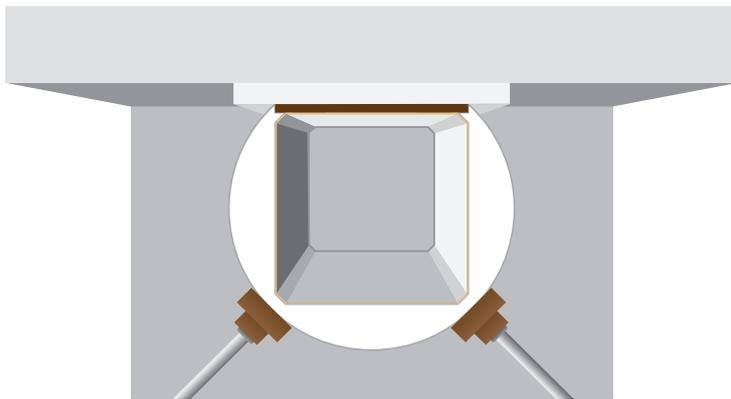

5.1. TUBOTEC Cuadrado [funda]

- Phenolic and/or metallic panels or similar.

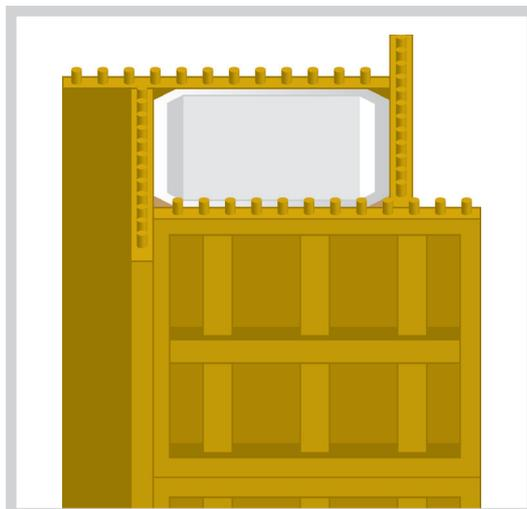

6. CONCRETING

It is recommended that, to obtain a better finish, the consistency of the concrete is fluid and the particle size uniform and suitable for exposed concretes. Pour the concrete from a height not exceeding 2m, in order to avoid excessive movement of the base. It is recommended not to pour the concrete all at once for heights over 8 m.

6.1. CONCRETING SPEED

Table 2. Concreting speed for polygonal formwork sections

Sections (mm)	Concreting speed (m/h)	Sections (mm)	Concreting speed (m/h)
150x150	6	450x450	3
200x200	6	500x500	3
250x250	6	550x500	2
300x300	5	600x600	2
350x350	4	650x650	2
400x400	3	700x700	2

Table 3. Concreting speed for circular formwork sections

Diameters (mm)	Concreting speed (m/h)	Diameters (mm)	Concreting speed (m/h)
150 a 350	6	500 a 800	3
400	5	850 a 1200	2
450	4		

6.2. CONCRETE POURING

The Spanish EHE-08 standard preconised to pour the concrete no higher than 1-2 meters. For formworks with higher height, its recommended to use hose concrete o similar product.



For formworks with expansion joint: Pour the concrete simultaneously on both sides to avoid overpressure on either side.



7. COMPACTING

It is recommended to compact the concrete every 60 cm in height of poured concrete, inserting the vibrator on each layer to compact it and to homogenize all components.

It is essential not to make movements in the steelwork that may cause bumps and scratches in the formwork, since they will show in the final finish of the pillar.

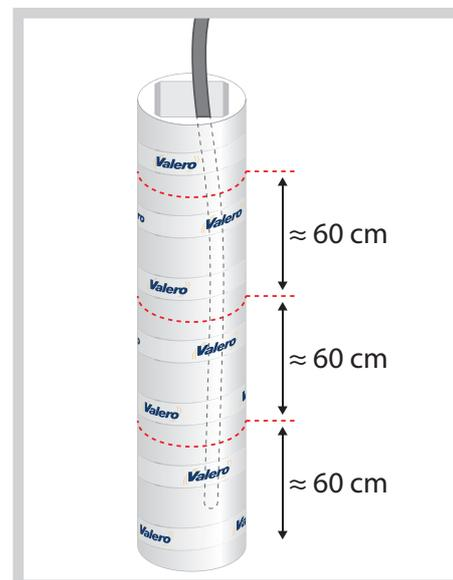

8. STRIPPING

The recommended time to remove Valero formworks is approximately ≤ 2 days, depending on the temperature and humidity conditions. It will be the works management who will determine the exact curing time.

Open the formwork as follows:

RELTEC CUADRADO, MEDIANERO, ESQUINERO Y COLUMNAS

Indicate the edge of the opening with a seal and use a cutter.



TUBOTEC CUADRADO [FUNDA]

Having a square exterior shape, it is recommended to be opened by any of the four edges or by the joint (in case there is), using a cutter.

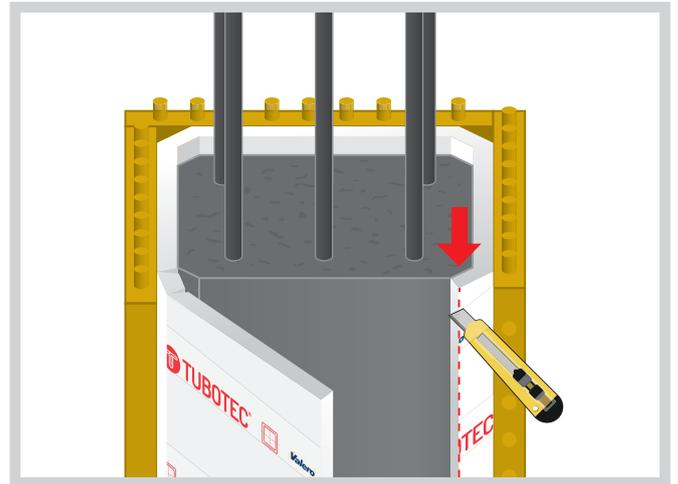

TUBOTEC CIRCULAR

Incorporates a system called "MF" made up of an opening marking and a wire for easy opening that breaks the cardboard layer.

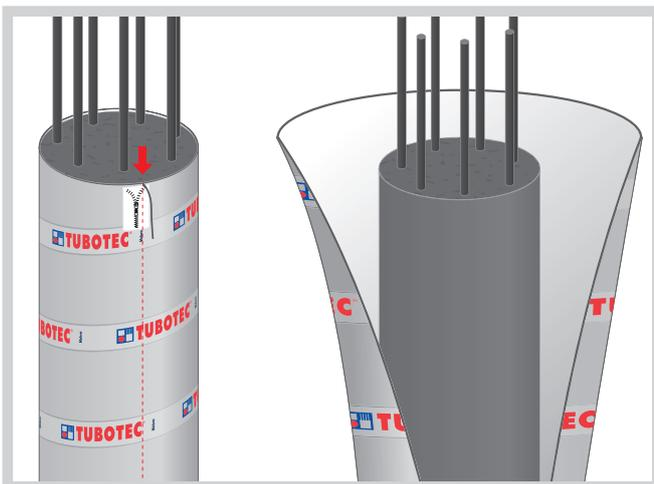

RELTEC CIRCULAR PS

Perform cut with a cutter on the side of the yellow reinforcement closure sheet.

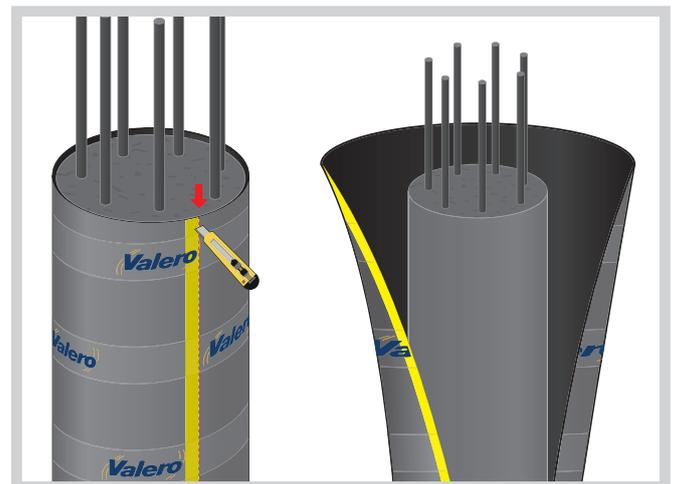

NOTE: THESE RECOMMENDATIONS ARE INDICATIVE AND MAY BE MODIFIED DEPENDING ON THE TYPE OF CONCRETE (FLUID, SOFT OR DRY CONSISTENCY) AND THE EXPERIENCE OF THE OPERATORS.