



# Installation & Operation Manual



**ONBOARD LOAD SCALE**  
EXTERIOR DIGITAL | 201-EBT-02(B)



Thank you for choosing to drive more and scale less! Here at Right Weigh, we are committed to making our products simple to install and easy to use. We understand that installation can vary between vehicles and yours may not be described in this manual. In any event, our technical support team is ready to answer your questions!



(503) 628-0838  
(888) 818-2058 - Toll Free (USA ONLY)  
+61 418 622840 - Australia & New Zealand



support@rwls.com  
leigh@rwlsau.com.au - Australia & New Zealand



[www.rwls.com/how-to-calibrate-install/](http://www.rwls.com/how-to-calibrate-install/)  
[rightweigh.com.au](http://rightweigh.com.au) - Australia & New Zealand

## IMPORTANT!

Please read instructions COMPLETELY and thoroughly before installation. Right Weigh, Inc. is not responsible or liable for product failure or vehicle damage due to improper installation. The installation requirements are outlined in this manual and should be followed thoroughly to avoid inaccuracy or damage to the product.

It is also important to be aware of vehicle manufacturer policies before making modifications to the vehicle. Right Weigh, Inc. is not liable or responsible for issues regarding warranties with other manufacturers. This is the responsibility of the customer. If you are unsure about how these installation practices apply to your vehicle, please contact your vehicle or component manufacturer.

Specifications & Overview	4
Scale Installation and Electrical Connections	6
Scale Operating Modes	9
Independent Mode	10
Sensor Average + Estimated Steer Mode	10
Independent + Estimated Steer Mode	11
Multiple Calibration Mode	11
Calibration	12
Operating & Weighing	14
Security PIN Code	15
Setting	15
Changing	16
Overweight Warning	17
Right Weigh Bluetooth™ App	18
General Information	18
Connecting To Gauge	20
Details Screen	22
Settings Screen	23
Troubleshooting	24
Appendix A - Additional Parts	26
Appendix B - Wiring Insulation	27
Warranty Statement	30

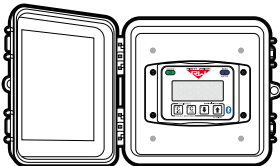

**ONBOARD LOAD SCALE**  
EXTERIOR DIGITAL | 201-EBT-02(B)



The Right Weigh 201-EBT-02(B) digital load scale has two internal air pressure sensors. This scale will monitor one air suspension axle group with two Height Control Valves (HCV's) or two axle groups with one HCV each. An axle group can be either a single, tandem, or triple set of axles on the truck or trailer.

### One Axle Group with 2 HCV

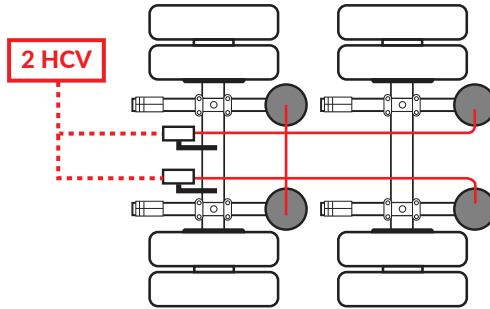

### Two Axle Groups with 1 HCV Each

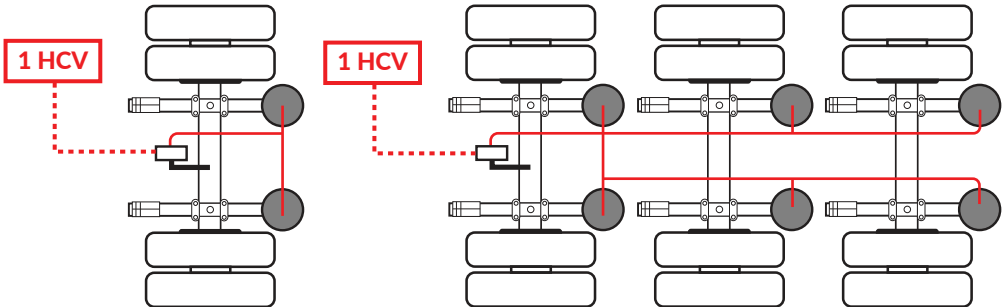

### Technical Specifications

Operating Temperature: -22° F to +185° F (-30° C to +85° C)

Storage Temperature: -40° F to +185° F (-40° C to +85° C)

Power Requirement: 9 VDC to 32 VDC (Switched)

Units: Pounds (LBS) or Kilograms (KG)

Housing: High impact polycarbonate blend

Display: 0.8" LCD sunlight readable

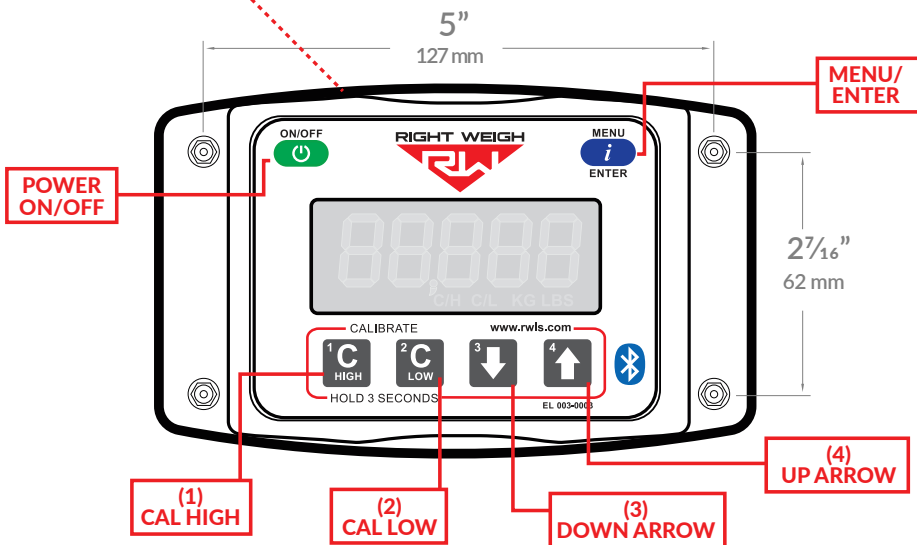
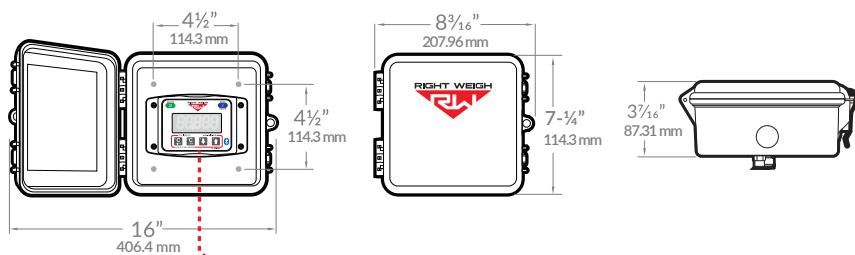

## Drop Axle:

This load scale can be used to monitor one axle group with an air ride lift axle if the lift axle air bags are controlled by the same height control valve as the other axles in the group. The scale will need to be setup using multiple calibration mode. Refer to the Multiple Calibration Mode section for more information.



Independently regulated lift axles cannot be considered part of an axle group and must be in the UP position when calibrating and weighing

## Estimated Steer Axle:

The weight of the steers can be estimated if this scale is used to monitor the drive axle group. Refer to the Estimated Steer Mode section for more information.

# SCALE INSTALLATION & ELECTRICAL CONNECTIONS



The 201-EBT-02 scale is designed to be mounted on the outside of a truck or trailer, however it must still be mounted in a protective enclosure. A protective box and mounting bracket are included with the 201-EBT-02B.

The following steps will walk you through how to correctly mount and install the scale. Be sure to choose a location that is easily accessible and safe from potential damage (forklift posts, tire caps, etc.)

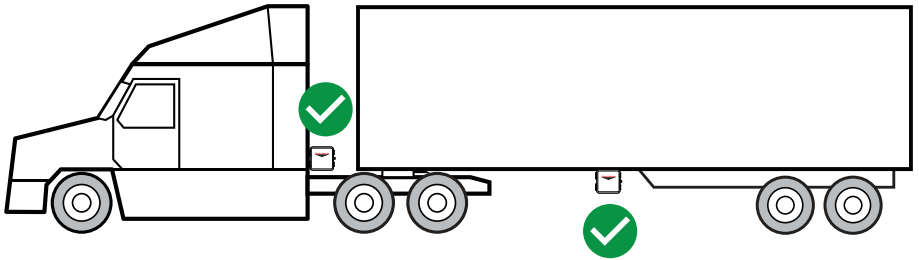

**DO NOT** mount the scale directly to the chassis or any other main beam unless it is approved by the vehicle manufacturer. Doing so may void the warranty with the vehicle manufacturer.

## 1 CHOOSE LOCATION

Make sure the location chosen is easily accessible and safe from potential damage (forklift posts, tire caps, etc.). Mount the bracket in the chosen location and install the gauge box to the bracket using supplied hardware.

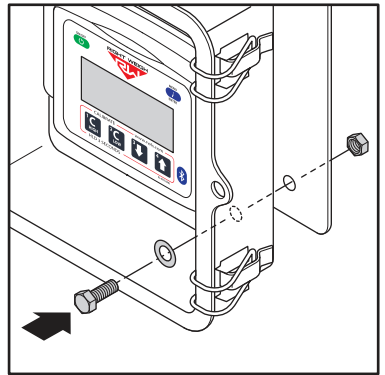

## 2 DUMP AIR FROM SUSPENSION SYSTEM

Locate and remove the suspension air line fitting from the top of one of the air bags connected to the Height Control Valve.

Remove suspension air line and fitting



## 3 INSTALL NEW 1/4" AIR LINE

Insert a street tee fitting into the top of the air bag that matches the thread size of the vehicle suspension. Reinstall the suspension air line and fitting into the street tee. Install a new 1/4" air line and fitting to be used with the gauge into the street tee. For more information on the parts needed for air line installation, see Appendix A.

Insert suspension air line and fitting into the tee fitting

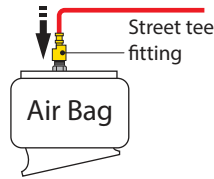

Insert new air line and fitting into the tee fitting

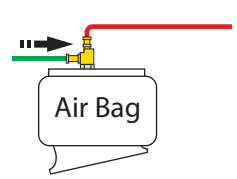

## 4 ROUTE AIR LINE TO GAUGE

Once the air line has been secured to the gauge, insert it into the correct push-to-connect fitting on the back (A). DO NOT ROTATE THE AIR FITTING!

## 5 REPEAT STEPS 2-4 WITH SECOND HCV

Second air line should connect to fitting B on the back of the gauge. For a dedicated tractor-trailer set, fitting A should be on the drive axle group and fitting B should be on the trailer axle group.

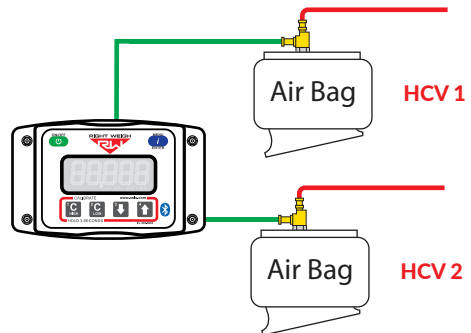

## 6 AIR UP SUSPENSION AND CHECK FOR LEAKS

## 7 CONNECT TO POWER / RS232

The cable coming out of the scale is used to power the scale and to transmit/receive vehicle data. Connect the **RED** wire to a switched positive (+) power source and the **BLACK** wire to chassis ground (-). The required supply voltage must be between 9 and 32 volts DC. For more information on wiring connection and insulation, see Appendix B.

The white and blue wires are for RS232 communication (use is optional). The **BLUE** wire is output from the scale (TX) and the **WHITE** wire is input to the scale (RX). For more information about this feature, please contact Right Weigh Technical Support listed on page 2.

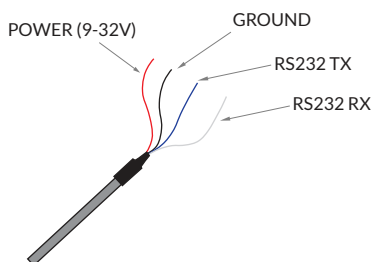

DO NOT connect directly to a battery or any constant power source, gauge should be connected to a switched source so that it can be disconnected from power when not in use. Most users connect the power to vehicle marker lights.

Electrical connections **MUST** be insulated, see appendix B for instructions.



The next few pages cover the operation modes that are built into the 201-EBT-02(B). **The load scale can only be setup in one operating mode at a time. If the mode is changed, the calibration data will be reset to factory defaults, requiring re-calibration.**

- **Sensor Average Mode (AVG):** This is the default mode of the scale. It will give you a single weight for the axle group it is attached to.
- **Independent Mode (IDP):** The inputs are separated for monitoring two axle groups with one HCV each.
- **Sensor Average + Estimated Steer Mode (S-AVG):** For monitoring the weight of a drive axle group and also calculating an estimated steer axle weight based on the weight ratio between the drive axle group and the steer axle.
- **Independent + Estimated Steer Mode (S-IDP):** For monitoring a single HCV drive axle group on sensor A, and a single HCV trailer axle group on sensor B, and estimating the steer axle weight based on the weight ratio between the drive axle group and the steer axle group.
- **Multiple Calibration Mode (4CAL):** Four sets of calibration data can be stored for use when the axle group is weighed under different conditions, such as when an integrated air ride lift axle is used on the same HCV.

## CHANGING SCALE MODES

PRESS



HOLDING

1: With the scale OFF, hold both the UP and DOWN arrow buttons, and press the ON/OFF button. Release all 3 buttons. The scale will display the current mode.



PRESS

2: Press the UP arrow button to cycle through the configuration modes. To confirm your selection, turn the scale off by pressing the ON/OFF button.



## INDEPENDENT MODE (IDP)

In Independent mode, a 201-EBT-02(B) can monitor the drive and trailer axle groups of a dedicated tractor-trailer set with single HCV's on each axle group. In this mode there is a small number in the lower right of the display indicating the axle group being monitored (1, 2, or 1 & 2 simultaneously).



Use the MENU button to switch the display between the axle groups. Axle group 1 will display the weight associated to sensor A and axle group 2 will show the weight associated to sensor B

## SENSOR AVERAGE + ESTIMATED STEER MODE (S-AVG)

In Estimated Steer mode, a 201-EBT-02(B) installed on a dual height control valve tractor to monitor the drive axle group can also estimate the steer axle weight. In this mode, there is a small number in the lower left of the display - either 1, 2, or 1 & 2 simultaneously - to let you know which axle group is being displayed. Axle group 1 displays the estimated steer axle weight, axle group 2 is the drive axle group weight, and 1 & 2 are the two weights combined.



Use the MENU button to switch the display between the axle groups.



Estimated steer is NOT for straight trucks or anyone who slides their fifth wheel regularly

## INDEPENDENT + ESTIMATED STEER MODE (S-IDP)

In Estimated Steer mode, a 201-EBT-02(B) installed on a dedicated tractor-trailer set with sensor A connected to the drive axle group and sensor B connected to the trailer axle group can also estimate the steer axle weight. In this mode, there is a small number in the lower left of the display - either 1, 2, 3, or 1 2 3 simultaneously - to let you know which axle group is being displayed. Axle group 1 displays the estimated steer axle weight, axle group 2 is the drive axle group weight, axle group 3 is the trailer axle weight, and 1 2 3 is the three weights combined.



Use the MENU button to switch the display between the axle groups.



Estimated steer is NOT for straight trucks or anyone who slides their fifth wheel regularly

## MULTIPLE CALIBRATION MODE (4CAL)

The 201-EBT-02(B) digital load scale in Multiple Calibration mode (4CAL) can store 4 sets of calibration data. This can be useful for an axle group which has one or more integrated air ride lift axle(s) using the same 2 HCV's, or a suspension which has many operating conditions.

For example, on some 4-axle heavy-haul trailers, there are 2 fixed axles, a lift axle, and a flip axle all on the same HCV. Many operators use calibration set "2" when only 2 axles are down, calibration set "3" when 3 axles are down, and calibration set "4" when all 4 axles are down.



Use the MENU button to switch the display between the different configurations.

# CALIBRATION



The 201-EBT-02(B) load scale must be calibrated both empty and loaded to work properly. The scale associates the air pressure in the suspension system to the weight you enter at the time of calibration. You will need to calibrate once while the vehicle is empty, and again while the vehicle is loaded for each axle group being monitored.

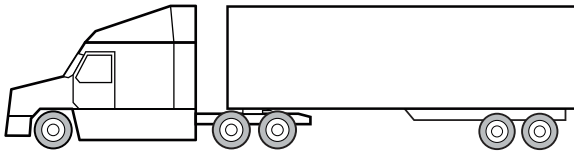

**STEER AXLE** **DRIVE AXLE GROUP (2 HCV)**

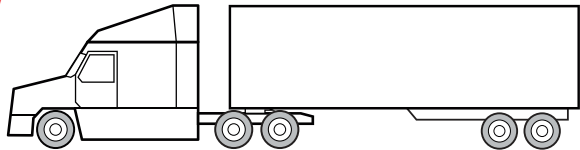

**STEER AXLE** **DRIVE AXLE GROUP (1 HCV)** **TRAILER AXLE GROUP (1 HCV)**

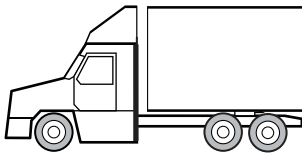

**DRIVE AXLE GROUP (2 HCV)**



Only enter on-the-ground weight of axle or group being monitored. **DO NOT** use gross weight, tare weight, etc.

Follow calibration steps on the next page, once these are complete the gauge will be ready to use!

## CHANGING UNITS

With the gauge on, hold the UP ARROW and then press the MENU button. This will toggle the settings between pounds and kilograms.



+



## EMPTY CALIBRATION POINT

1: While the vehicle is empty, obtain axle group weights from a certified in-ground scale.

2: Park on a level surface. Shift the transmission to neutral and set the parking brakes. Chock the wheels to prevent unexpected vehicle movement, then release the parking and service brakes.

3: Make sure the Height Control Valve (HCV) has fully inflated the air bags. If needed, briefly dump the air from the suspension and allow the HCV to refill the system.



4: Press the ON/OFF button to turn on the Right Weigh load scale.



5: For IDP, S-AVG, S-IDP, and 4CAL modes, press the blue MENU button to select the proper axle group or calibration set.



6: Press and hold the C LOW button until the "C/L" symbol appears.



7: Adjust the value using the UP and DOWN arrows so that it matches your scale ticket for the axle group.



8: To save, press and hold the C LOW button until the "C/L" symbol disappears.

9: Repeat steps 5-8 for all axle groups or calibration sets.

## LOADED CALIBRATION POINT



Repeat "empty calibration point" steps 1-3 with the vehicle fully loaded



4: Press the ON/OFF button to turn on the Right Weigh load scale.



5: For IDP, S-AVG, S-IDP, and 4CAL modes, press the blue MENU button to select the proper axle group or calibration set.



6: Press and hold the C HIGH button until the "C/H" symbol appears.



7: Adjust the value using the UP and DOWN arrows so that it matches your scale ticket for the axle group.



8: To save, press and hold the C HIGH button until the "C/H" symbol disappears.

9: Repeat steps 5-8 for all axle groups or calibration sets.

Follow these steps while weighing your vehicle:

1: Park on a level surface. Shift the transmission to neutral and set the parking brakes.

2: Chock the wheels to prevent unexpected vehicle movement, then release the parking and service brakes.

3: Make sure the Height Control Valve (HCV) has fully inflated the air bags. If needed, briefly dump the air from the suspension and allow the HCV to refill the system. (This may take several minutes depending on the type of HCV.)



4: Press the ON/OFF button to turn on the Right Weigh load scale.

5: Adjust the suspension or the load itself until the Right Weigh load scale displays a weight value below your legal limit.



6: For IDP, S-AVG, S-IDP, and 4CAL, press the blue MENU button. Repeat for drive axle group or other configurations.



7: Press the ON/OFF button to turn off the Right Weigh load scale.

Adding a security PIN will prevent tampering with the gauge. Once set, the PIN will be required to change calibration data and to change the PIN code.

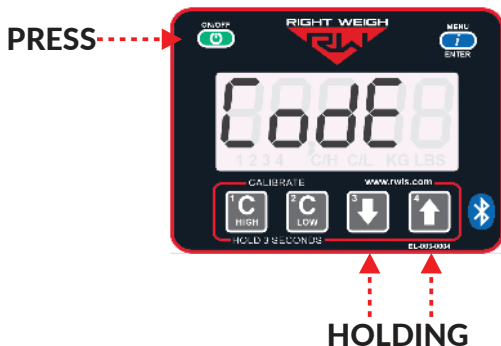

With the gauge off, hold both the C LOW and C HIGH buttons, then press the ON/OFF button and release all three.



Press the MENU button and “00000” will display on the screen. Enter a 5 digit PIN code using the 1, 2, 3, and 4 buttons. Press the MENU button again to save the code.

**\*\*If the display shows “-----”, then there is already a code set. See next page to change existing PIN code\*\***

# CHANGING SECURITY PIN CODE



With the gauge off, hold both the C LOW and C HIGH buttons, then press the ON/OFF button and release all three.

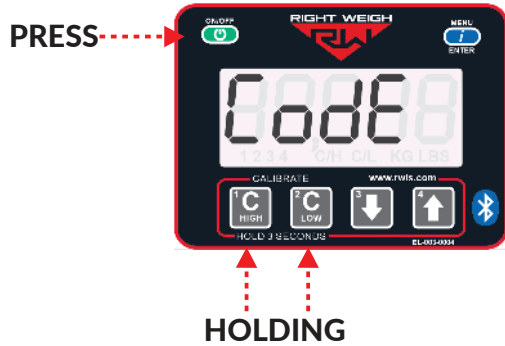

Press the MENU button and "-----" will display on the screen. Enter the previous PIN code. If the code entered is correct, the display will show "Good".



Press the MENU button and enter the new 5-digit PIN code using the 1, 2, 3, and 4 buttons. Press the MENU button again to save the code.





The overweight warning can be added as a visual warning to the driver to flash anytime the gauge reads above a set weight.



HOLD

With the scale turned on, press and hold both the C HIGH and C LOW buttons until the “C/H” symbol appears.



The default display will show “0”. Setting this to “0” will turn off the overweight feature.



HOLD TO SAVE

ADJUST

Use the UP and DOWN arrows to set the desired warning weight. Press and hold the C HIGH and C LOW buttons to save.



Setting the warning value to “0” will disable the overweight warning feature



## RIGHT WEIGH LOAD SCALES APP



Go to the Google Play or App Store and download the Right Weigh Load Scales App!

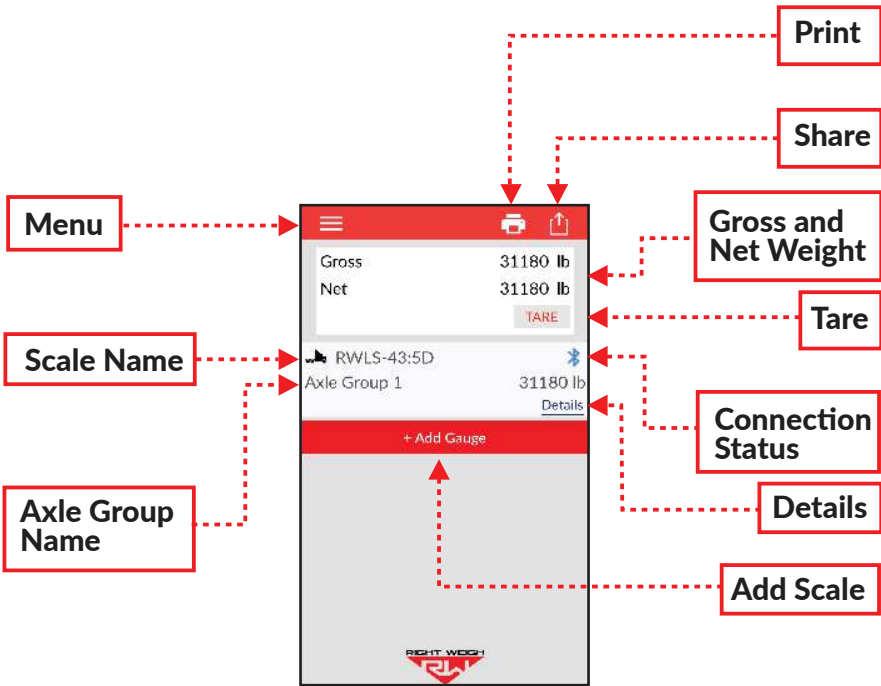



## MENU

The menu icon will give you the option of displaying your weight data (storage frequency dependent on save settings), seeing the app settings, and will take you to a support page for more information on how to contact Right Weigh, Inc.

## SCALE NAME

Once you have connected the gauge to your phone app, the scale name will display here.

## AXLE GROUP NAME

These names represent the axle group the gauge is monitoring and is dependent on the set-up of the scale itself.

## PRINT

The print icon will allow you to print a weight receipt to most Bluetooth "POS" receipt printers with your weight data and location on it.

## SHARE

The share icon will allow you to send your weight data via email or text message.

## GROSS AND NET WEIGHT

Here you can see your gross weight and net weight. Gross weight is the total weight of all axle group readings from the gauge and the net weight can be zeroed by pressing the "TARE" button. All axle groups must be monitored for a correct gross or net weight.

## TARE

Pressing the "TARE" button will zero the net weight. This reading will display the net change in total weight since the last time the ZERO button was pressed. See page 23 for more information on how to turn on this feature.

## CONNECTION STATUS

A blue icon means the scale is connected. If the icon is gray, the scale has been disconnected or is out of range and pressing the refresh icon will allow the app to attempt to reconnect.

## DETAILS

Clicking on the Details button will send you to a details page with more information on the scale status.

## ADD SCALE

Once your scale has been connected to power, you can click the "+ Add Gauge" button to find each scale on your vehicle. Be sure to add them in the order they appear on your vehicle



1

With the gauge off, hold down the MENU button, press the ON/OFF button, and release both simultaneously.

PRESS



HOLD

2

Press the MENU button twice to see the unique identifier.



PRESS  
x2

3

Once the app has been downloaded and opened, you will see the home screen with no gauge connected to it and a gross weight of "0".

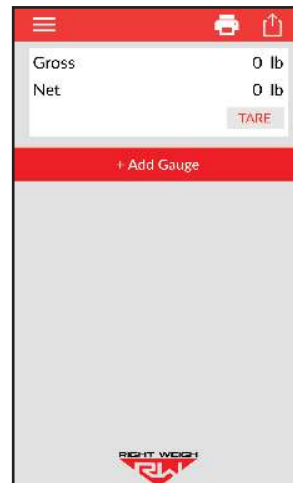

## 4

On the app home screen, press the “Add Gauge” button and choose whether or not the gauge is connected to the truck or trailer.

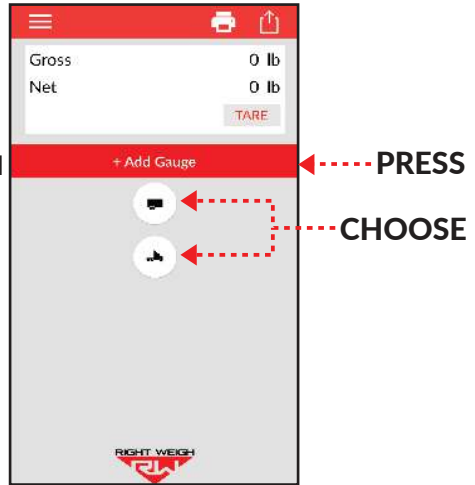

## 5

Select the gauge that matches the unique identifier name from step 3 to add the gauge to your home screen.

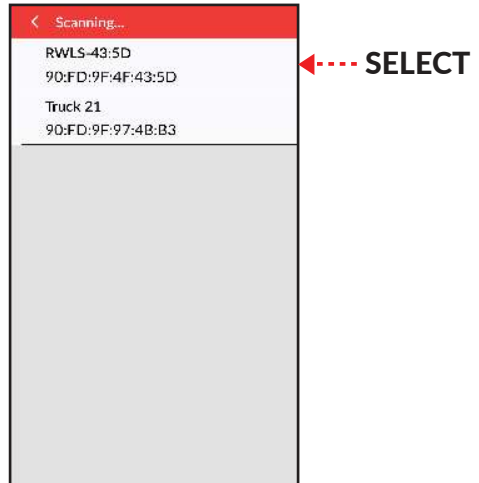



To get to the scale details screen, press on “Details” from the home page. This page will display information for that specific scale and includes the ability to rename the scale.

## RENAME THE SCALE

To re-name the scale, select the pencil icon. When finished, press “OK” to save. If the name doesn’t change, try deleting the scale and re-adding it on the app

DELETE SCALE FROM APP

## SCALE INFORMATION

Under the scale name, you can find the scale’s unique identifier, connection status, and weight information

## RAW SENSOR INFORMATION

Here you can find the psi value for each air sensor.

## WARNING AND OVERLOAD WEIGHTS

These weights are typically set in the “Settings” menu on the app but can be overwritten for each scale individually

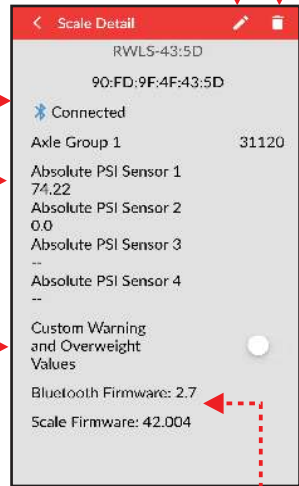

SCALE FIRMWARE VERSION

To get to the settings screen, press the menu button on the top left of the home screen and navigate to “Settings”

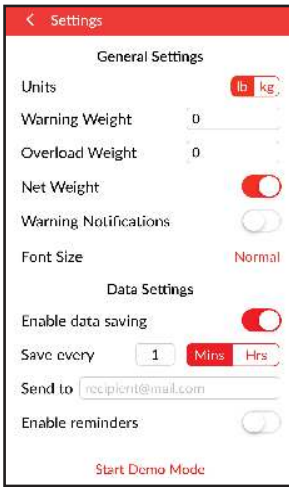

### CHANGING UNITS

Change the units to either pounds (LB) or kilograms (KG)

### SET WARNING AND OVERLOAD WEIGHTS

Set warning and overload weight limit defaults

### NET WEIGHT

Toggle the net weight feature on/off. Net weight is the net change in weight since the last time the “TARE” button was pressed.

### DATA SAVING

Specify data saving and where to send the information to

### DEMO MODE

Turn on demo mode to see all the app features without connecting to a gauge

## PROBLEM WITH THE GAUGE?

Below is a list of problems we have seen with a simple fix. If you don't see your problem listed here or our troubleshooting doesn't fix your problem, call Right Weigh Tech Support listed on page 2 for further assistance!

### ERRATIC / INACCURATE READINGS

The vehicle is not parked on a level surface:

Parking on sloped or banked surfaces will cause the vehicle weight distribution to shift between the axle groups.

The vehicle's brakes are on:

When the vehicle brakes are set, they could apply additional pressure or torque on the suspension air bags. This will cause the suspension to have a different air pressure than what is normally needed to hold up the given weight.

The vehicle is parked on an uneven or rough surface:

If one or more of the vehicle's wheels are in a pothole, that could result in additional pressure or torque on the suspension air bags. This will cause the suspension to have a different air pressure than what is normally needed to hold up the given weight.

There is a significant air leak in the suspension system:

This could cause the HCV to refill the suspension at regular intervals to maintain the vehicle's ride height. If there is a significant leak, the gauge display will slowly decrease in value and then quickly increase in value when the HCV refills the suspension system.

The Height Control Valve (HCV) is malfunctioning or broken:

If the HCV is not functioning correctly, the air pressure applied to the suspension system could be inconsistent and/or erratic. To test for an HCV problem, acquire a weight reading from the Right Weigh gauge and write it down (refer to gauge operating instructions for proper procedure). Drive the vehicle around the block and return to the same location. Acquire a second reading from the Right Weigh gauge. If the two readings are significantly different, then the HCV might be malfunctioning.

### SCALE DISPLAY IS BLINKING

Current weight is above the alarm limit programmed by the user:

With scale on, press and hold the 1 & 2 buttons simultaneously. The display will show the alarm limit weight. To remove the alarm weight, set this number to 0 using the down arrow, and then hold 1 & 2 again until the display is cleared.



## APP WON'T CONNECT TO THE GAUGE

### Scale is connected to a constant power source:

The gauge should never be connected to a constant power source, rewire so that it is connected to a switched power source. If the gauge is powered too long it can stop transmitting a Bluetooth signal and may need to be disconnected and reconnected to work again.

### Scale is already connected to another device:

The scale can only connect to one device at a time

### Phone needs to be re-set:

To reset your phone - close the app, turn off Bluetooth, and wait 10 seconds. Then open the app and turn the Bluetooth back on. Try rescanning for the scale. If this still doesn't work, in some cases it is necessary to restart the phone completely.

## SCALE DOES NOT POWER ON

### Scale is not connected to a switched power source of between 9 and 32 volts:

If there is a bad connection in the circuit which causes voltage to drop below 9 volts, the scale will not power on. Test the power source with a voltmeter.

### Scale connected directly to battery:

The scale is active anytime it is connected to power, even if the display is off. To reset it, disconnect and reconnect the power source, wait 10 seconds, then try again to turn the display on.

### Polarity is incorrect:

The red wire must be connected to positive and the black to negative.

## CANNOT CHANGE CALIBRATION DATA

### The scale has an active user-defined security PIN:

If the scale is protected with a PIN code, the PIN must be entered before calibration data can be changed. The scale will display "CodE" and the previously set 5-digit PIN code must be entered to change the data.

## GAUGE WILL NOT CALIBRATE LOW/HIGH

### Air pressure in the system is not changing:

To enter low or high cal mode, the gauge must see a measurable change in air pressure. Make sure you calibrate high when the vehicle is near the legal limit and calibrate low when the truck is empty. Also, be sure the air line is connected directly to an air bag NOT the main air supply or brake system.

The following is a list of additional parts needed for air line installation. This list is just a suggestion and may not be all of the parts needed for your specific vehicle. Check with your Right Weigh dealer for optional installation kits.

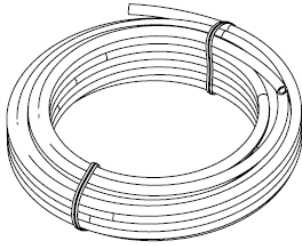

### 1/4 Inch Air Line

Approximately 20 to 30 feet (6 to 9 meters)

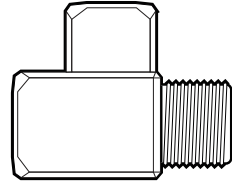

### Street Tee Fitting

The thread size should match the air bag fitting. (1/4" NPT or 3/8" NPT)

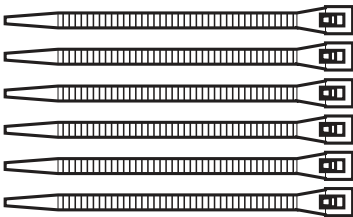

### 20 or more Zip Ties

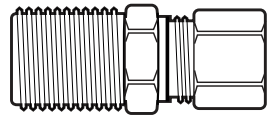

### Male Straight Fitting

Air line fitting for 1/4" air line, with a thread size to match the street tee fitting.

It is very important that all wiring connections be made watertight. Connections which are not watertight can allow moisture to travel through the individual strands of the wires and make it's way into the scale, causing permanent damage to the electronics.

Heat shrinkable splices are included in the 201-SK Installation Kit.

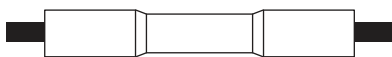

**Crimp each end of the wire into the connector with a wire crimp tool (tool not provided).**

After crimping and heat shrinking



**With a heat gun or heat torch, heat the connector until it shrinks completely around each wire end. Make sure you do not burn the wire jacket.**

Add heat shrink



After heat shrinking



**After all connections have been made, heat shrink the entire group of splices so that it seals on the outer jacket of both cables.**







Right Weigh is committed to providing quality products that function as intended, and we always stand behind our workmanship. Our industry leading warranty is our best effort to express this commitment. Products manufactured or sold by Right Weigh, Inc. are warranted to be free from significant defects in material and workmanship 3 years from date of purchase. During this time, and within the boundaries set forth in this warranty statement, Right Weigh, Inc. will, at its sole discretion, correct the product problem or replace the product.

This warranty shall not apply to product problems resulting from: (1) Improper application, installation, incorrect wiring, or operation outside of the approved specifications of the product. (2) Accidents, faulty suspension parts or power surges (3) Inadequate maintenance or preparation by the buyer or user (4) Abuse, misuse, or unauthorized modification. (5) Acts of God, lightning strike, floods, fire, earthquake, etc.

Right Weigh, Inc. assumes no responsibility or liability for any loss or damages resulting from use of Right Weigh, Inc. products.

In no event shall Right Weigh, Inc. be liable for direct, indirect, special, incidental or consequential damages (including loss of profits or loss of time) resulting from the performance of a Right Weigh, Inc. product. In all cases, Right Weigh, Inc. liability will be limited to the original cost of the product in question. Right Weigh, Inc. reserves the right to make improvements in design, construction, and appearance of products without notice.

## Return Policy and Authorization

Before returning any product, please obtain a Return Merchandise Authorization number (RMA#) by calling Customer Service at 503-628-0838 or e-mailing [support@rws.com](mailto:support@rws.com). Include the RMA# and information regarding the reason for the return with the returned product. Shipping costs for returns must be prepaid by the customer. For your protection, items must be carefully packed to prevent damage in shipment and insured against possible damage or loss. Right Weigh, Inc. will not be responsible for damage resulting from careless or insufficient packing or loss in transit.

An RMA# must be obtained by the original purchaser before any product can be returned. Only new, unused products may be returned. Installed, used, damaged, modified or customized products can not be returned for credit. Credit will be issued to the original purchaser after evaluation by Right Weigh, Inc.

## Repairs/Replacements

An RMA# must be obtained before any product can be returned. Right Weigh, Inc. will evaluate returned products at no charge. If Right Weigh, Inc. determines that the returned product is under warranty it will repair the product or parts thereof at no charge, or if unrepairable, replace it with the same or functionally equivalent product whenever possible. Right Weigh, Inc. will return the product at its expense via a shipping method (carrier to be at sole discretion of Right Weigh, Inc.) equal to or faster than the method used by the customer. Products or parts thereof not covered by warranty will be repaired or replaced at customer expense upon authorization by the customer. Right Weigh, Inc. will return the repaired product at customer expense via a shipping method (carrier to be at sole discretion of Right Weigh, Inc.) equal to or faster than the method used by the customer.

For additional support contact:

**United States and Canada:**

Right Weigh, Inc.

(503) 628-0838

(888) 818-2058 - Toll Free (USA ONLY)

[www.rwls.com](http://www.rwls.com)

[support@rwls.com](mailto:support@rwls.com)

**Australia and New Zealand:**

Smart Truck Solutions

+61 418 622840

[rightweigh.com.au](http://rightweigh.com.au)



Right Weigh, Inc.  
Hillsboro, Oregon USA

PP-003-0015 Revision F

June 2020

©2015-2020 Right Weigh, Inc. All rights reserved.