

Item # _____

Project _____

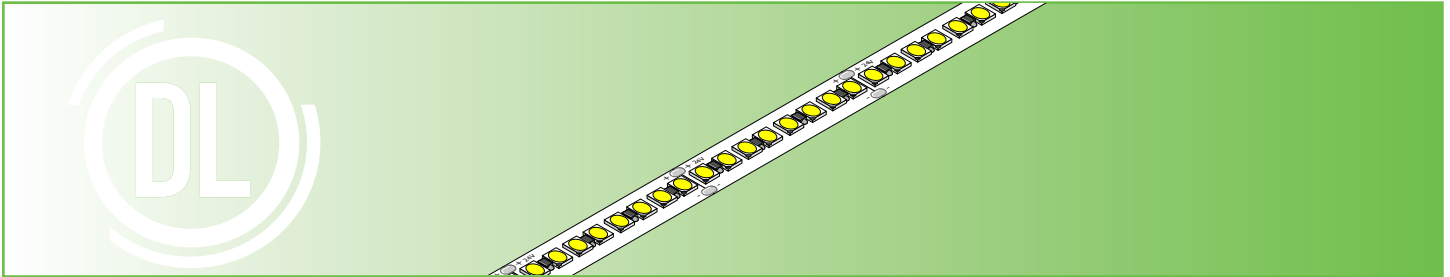

FEATURES

- Superior CRI, 95+
- High R9 (95) & R13 (100) values
- Full color rendering consistency at different output levels
- Fully diffused in channel
- Ultra high lumen output capability
- Channel (extrusion) not required for heat sink

SPECIFICATIONS

DI-24V-	VLX1	VLX2	VLX3	VLX5	VLX8	
Voltage	24VDC					
Wattage	1.0W/ft.	1.9W/ft.	2.8W/ft.	4.6W/ft.	7.2W/ft.	
Lumens¹	2400K	104/ft.	194/ft.	299/ft.	469/ft.	730/ft.
	2700K	101/ft.	207/ft.	311/ft.	495/ft.	782/ft.
	3000K	106/ft.	218/ft.	323/ft.	557/ft.	853/ft.
	3500K	108/ft.	218/ft.	328/ft.	586/ft.	906/ft.
	4200K	112/ft.	228/ft.	342/ft.	550/ft.	850/ft.
	5000K	116/ft.	242/ft.	365/ft.	592/ft.	840/ft.
	6300K	112/ft.	244/ft.	363/ft.	578/ft.	924/ft.
Max. Run²	80 feet	53 feet	41 feet	30 feet	19 feet	
Cut Points	1.32 in					
LED Chips	72/ft					
CRI	95+					
Dimmable	Yes					
Field Cuttable	Yes					
Dimensions	0.47 x 0.1 in. (W x H)					
Environment*	Indoor / Damp Location					
Certification	UL Listed 2108					
Warranty	12-Year Warranty					

***WARNING: NOT FOR USE IN SUBMERSIBLE APPLICATIONS**

© 2021 Elemental LED, Inc. All rights reserved.
Specifications are subject to change without notice.

Toll Free: 877.817.6028 | Fax: 415.592.1596 | www.DiodeLED.com | info@DiodeLED.com

VALENT® X 100/200/300/500/800 – 24V LED Strip Light

SPECIFICATION SHEET

CUSTOM LENGTH TAPE

SKU Builder

DL

DI - **24V** - [] - [] - []

Voltage Model Color Temp Length

MODEL		COLOR TEMP		LENGTH
VLX1	VLX5	24	42	CSTM (in.)
VLX2	VLX8	27	50	016
VLX3		30	63	100
		35		

Example: DI-24V-VLX8-30-016 = Diode LED, 24 Volt, VALENT® X, 3,000° CCT, 16.4 foot spool.

NOTE: All custom cut Tape Lights include 96" lead wires.

FULLY LOADED CHANNELS

FULLY LOADED SKU Builder

DI - **LOADED** - [] - [] - **24V** - [] - [] - [] - [] - [] - [] - []

Channel Type Channel Color Voltage Strip Type CCT Lens Length (In.) Driver** (Optional) Mounting** (Optional)

CHANNEL TYPE		CHANNEL COLOR	STRIP TYPE	CCT		LENS	DRIVER**		MOUNTING**	
SL*	45DCO			VLX1	24		42	CL	ELECTRONIC (ELEC)	
SQ*	DOME	AL	VLX2	27	50	FR	MAGNETIC (MAG)		VERTICAL MOUNTING CLIPS (VERT)	
45*	SQC20	WH*	VLX3	30	63		TRIAC (TRI)		ROTATING MOUNTING CLIPS (RTC)	
REC	RC20	BL*	VLX5	35			0-10V (010)		TAPE (TP)	
RFCTR	CA		VLX8				SWITCHEX (SWX)		HANGING HARDWARE (HNG)	
							LUTRON (LUT)			

*Black and White Channel Color options only available for (SL) Slim, (SQ) Square, & (45) 45 Degree.

**Driver and Mounting selections are for specifying purposes only. Driver and mounting options must be purchased separately.

Example: DI-LOADED-SQBL-24V-VLX8-CL-36-SWX-RTC = Diode LED, Fully Loaded, Square, Black Channel, 24 Volt, VALENT® X 800, Clear Lens, 36 inches, 96" Lead Wire, SWITCHEX Dimmer, and Rotating Mounting Clips.

NOTE: Channels are not required for use as a heat sink

1. Lumen value measured in accordance to IES LM-80-08. LED chips have a luminous flux range with a tolerance of +/- 5%.
2. Each maximum run requires a dedicated power feed from the driver. Do not extend beyond the recommended maximum run length. Max run may exceed Class 2 limit. Actual wattage may differ from calculated wattage due to voltage drop across run.
3. Actual efficacy value is dependent to specified LED driver (power supply). An estimated efficacy value can be calculated as follows: Lumen value divided by average power consumption per foot.
4. Do not install product in an environment outside the listed ambient temperature. Exceeding the maximum ambient temperature may damage LED chips, reduce the total lamp life, lumen output, and/or adversely impact color consistency.
5. Operating temperature is measured according to the minimum and maximum ambient temperature environment.

VALENT® X 100/200/300/500/800 – 24V LED Strip Light

SPECIFICATION SHEET

MECHANICAL DIAGRAM

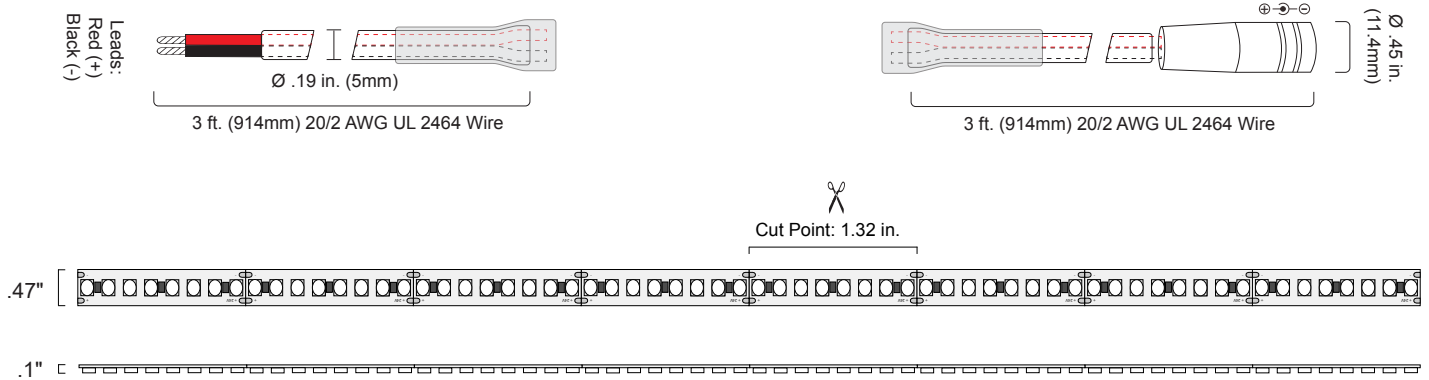

BUILDER CHANNELS

NOTE: Builder channel covers are sold separately.

BUILDER CHANNEL SLIM (SL)

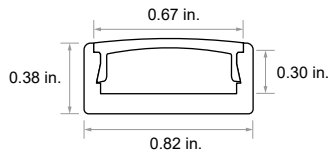

CHANNEL ONLY SKU	FINISH	LENGTH	PRODUCT INCLUDES
DI-CPCHA-SL48**	AL	48 in.	Mounting Clips sold separately.
DI-CPCHA-SL48W**	WH		
DI-CPCHA-SL48B**	BL		
DI-CPCHA-SL96**	AL	96 in.	Mounting Clips sold separately.
DI-CPCHA-SL96W**	WH		
DI-CPCHA-SL96B**	BL		

BUILDER CHANNEL 45° (45)

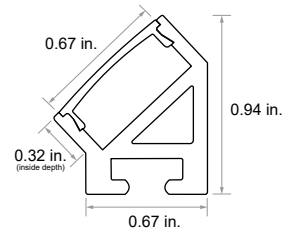
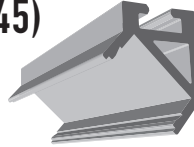

CHANNEL ONLY SKU	FINISH	LENGTH	PRODUCT INCLUDES
DI-CPCHA-4548**	AL	48 in.	4 Mounting Clips with screws and 2 End-to-End Interconnects.
DI-CPCHA-4548W**	WH		
DI-CPCHA-4548B**	BL		
DI-CPCHA-4596**	AL	96 in.	8 Mounting Clips with screws and 4 End-to-End Interconnects.
DI-CPCHA-4596W**	WH		
DI-CPCHA-4596B**	BL		

** - SKUs listed above are for Single Channels only. Add a -10 for a 10 pack bundle (10 pack will include 10x the amount included accessories)

BUILDER CHANNEL SQUARE (SQ)

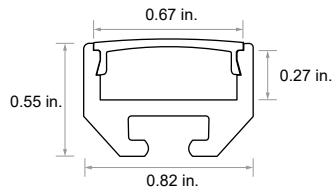
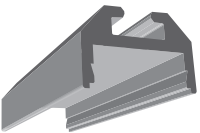

CHANNEL ONLY SKU	FINISH	LENGTH	PRODUCT INCLUDES
DI-CPCHA-SQ48**	AL	48 in.	4 Mounting Clips with screws and 2 End-to-End Interconnects.
DI-CPCHA-SQ48W**	WH		
DI-CPCHA-SQ48B**	BL		
DI-CPCHA-SQ96**	AL	96 in.	8 Mounting Clips with screws and 4 End-to-End Interconnects.
DI-CPCHA-SQ96W**	WH		
DI-CPCHA-SQ96B**	BL		

** - SKUs listed above are for Single Channels. Add a -10 for a 10 pack bundle (10 pack will include 10x the amount included accessories)

NOTE: Channels are not required for use as a heat sink

VALENT® X 100/200/300/500/800 – 24V LED Strip Light

SPECIFICATION SHEET

CHANNEL BUNDLES

NOTE: Channel Bundles are **not** interchangeable with each other **nor** compatible with Builder channels.

CHANNEL BUNDLE 45° DECO (45DC)

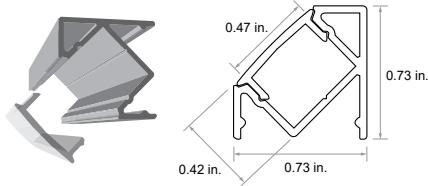

CHANNEL ONLY SKU

PRODUCT INCLUDES

- DI-CPCHB-45DCO-48
- 48 in. channel & frosted cover
- End caps: 1x open, 1x closed
- Mounting hardware

CHANNEL BUNDLE 20mm SQUARE CORNER (SQ20)

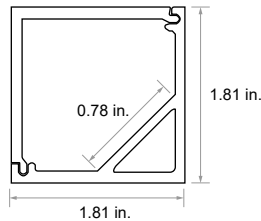

CHANNEL ONLY SKU

PRODUCT INCLUDES

- DI-CPCHB-SQC20-48
- 48 in. channel & frosted cover
- End-caps: 1x open, 1x closed
- Mounting hardware

CHANNEL BUNDLE 20mm ROUNDED CORNER (RC20)

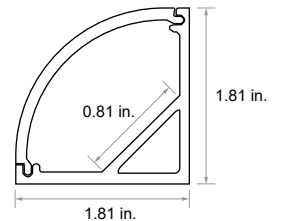
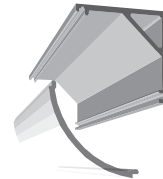

CHANNEL ONLY SKU

PRODUCT INCLUDES

- DI-CPCHB-RC20-48
- 48 in. channel & frosted cover
- End-caps: 1x open, 1x closed
- Mounting hardware

CHANNEL BUNDLE DOME (DME)

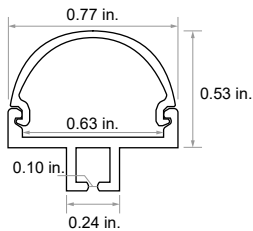
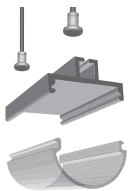

CHANNEL ONLY SKU

PRODUCT INCLUDES

- DI-CPCHB-DOME-48
- 48 in. channel & frosted cover
- End caps: 1x open, 1x closed
- 2x pendant hardware

CHANNEL BUNDLE REFLECTOR (RFC)

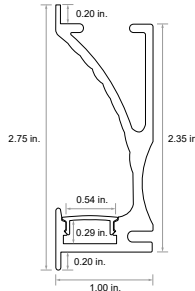

CHANNEL ONLY SKU

PRODUCT INCLUDES

- DI-CPCHB-RFCTR-48
- 48 in. channel & frosted cover
- End caps: 1x open, 1x closed

CHANNEL BUNDLE RECESSED (REC)

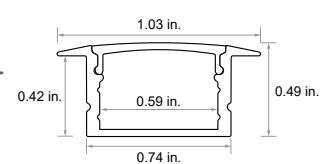
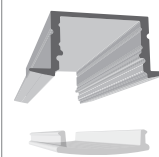

CHANNEL ONLY SKU

PRODUCT INCLUDES

- DI-CPCHB-REC-48
- 48 in. channel & frosted cover
- End caps: 1x open, 1x closed
- Mounting hardware

CHANNEL BUNDLE CANAL (CA)

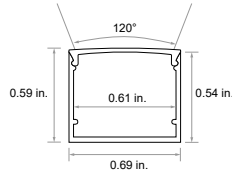
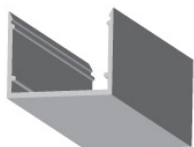

CHANNEL ONLY SKU

PRODUCT INCLUDES

- DI-CPCHB-CAN48
- 48 and 96 in. channel & opal cover
- End caps: 1x open, 1x closed
- 2x mounting clip
- DI-CPCHB-CAN96
- 96 in. channel & opal cover
- End caps: 2x open, 2x closed
- 4x mounting clip

NOTE: Channels are not required for use as a heat sink

VALENT® X 100/200/300/500/800 – 24V LED Strip Light

SPECIFICATION SHEET

COMPATIBLE PRODUCTS

The following Listed LED Drivers are recommended for compatibility and to meet NEC code when installed according to specifications. For additional LED Driver options see Diode LED's product page at: <https://www.diodeled.com/products/led-power-supplies.html>

STAND ALONE

SWITCHEX® DRIVER + DIMMER SWITCH

SWITCHEX combines an LED driver and LED dimmer switch into a single integrated unit. Fits into standard switch boxes.

[SPEC SHEET](#)

	Voltage Output		Power Output
DI	24V	SE	60W

SKU	L - LENGTH	W - WIDTH	H - HEIGHT
DI-24V-SE-60W	1.40 in.	2.10 in.	4.10 in.
DI-24V-SE-100W	1.40 in.	2.10 in.	4.10 in.

Fits in Standard Switch Box

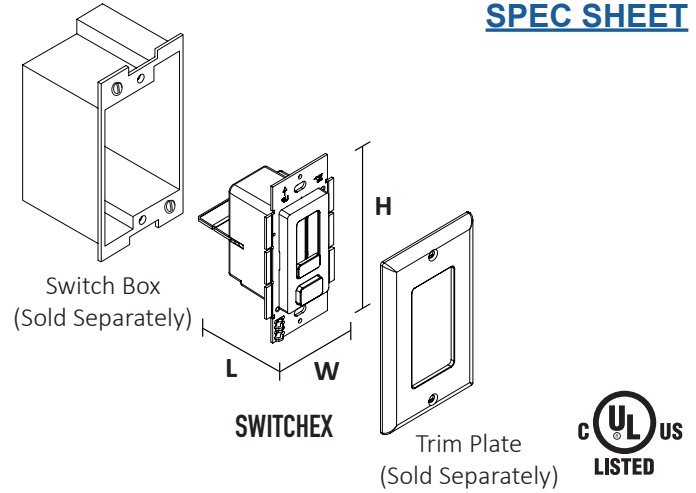

ON/OFF, DMX, & PWM CONTROL

LO-PRO® JUNCTION BOX & DRIVER COMBO - 24V CONSTANT VOLTAGE LED DRIVER

Use Constant Voltage Drivers to power your lighting system. Compatible with Standard 120VAC On/Off Switches, REIGN® Low Voltage Dimmers, TOUCHDIAL™ Control System, DMX Decoders, and PWM Controls.

[SPEC SHEET](#)

	Voltage & Power Output	Junction Box
DI	0970	LPS

SKU	L - LENGTH	W - WIDTH	H - HEIGHT
DI-0970-LPS	11.25 in.	3.75 in.	1.90 in.
DI-CV-MW24V60W-277-LPS	11.25 in.	3.75 in.	1.90 in.
DI-CV-MW24V90W-277-LPS	11.25 in.	3.75 in.	1.90 in.
DI-0954-LPL	13.5 in.	4.5 in.	2.37 in.

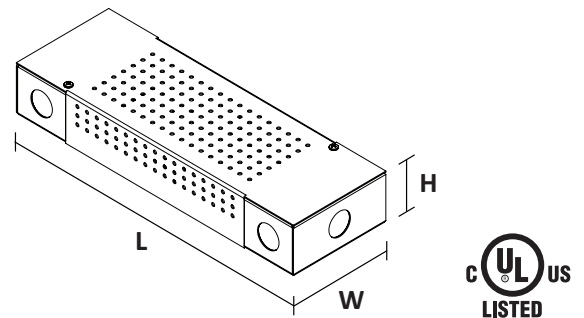

VALENT® X 100/200/300/500/800 – 24V LED Strip Light

SPECIFICATION SHEET

COMPATIBLE PRODUCTS

The following Listed LED Drivers are recommended for compatibility and to meet NEC code when installed according to specifications. For additional LED Driver options see Diode LED's product page at: <https://www.diodeled.com/products/led-power-supplies.html>

0-10V

LO-PRO® JUNCTION BOX & DRIVER COMBO - 24V COMMERCIAL GRADE 0-10V LED DIMMABLE DRIVER

Compatible with 0-10V controls and dimming systems.

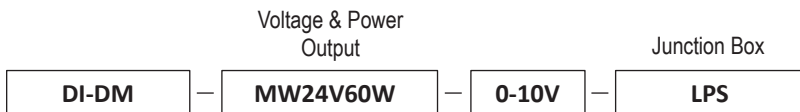

SKU	L - LENGTH	W - WIDTH	H - HEIGHT
DI-DM-MW24V60W-0-10V-LPS	11.25 in.	3.75 in.	1.90 in.
DI-DM-MW24V90W-0-10V-LPL	13.5 in.	4.5 in.	2.37 in.

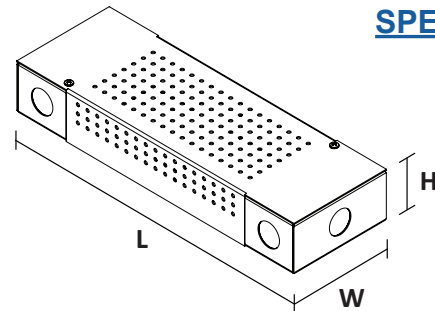

[SPEC SHEET](#)



ELECTRONIC DRIVERS

OMNIDRIVE® 24V ELECTRONIC DIMMABLE LED DRIVER

Compatible with Forward Phase and Reverse Phase Dimmers. Please see Diode LED's Compatibility List at: <https://www.diodeled.com/custom/download/productFile/filename/dimmer-master-compatibility-guide.pdf>



SKU	L - LENGTH	W - WIDTH	H - HEIGHT
DI-TD-24V-10W	a 5.5 in.	1.8 in.	1.1 in.
DI-TD-24V-20W	a 5.5 in.	1.8 in.	1.1 in.
DI-TD-24V-30W	a 7 in.	2.3 in.	1.4 in.
DI-TD-24V-45W	a 7 in.	2.3 in.	1.4 in.
DI-TD-24V-60W	b 7.9 in.	2.7 in.	1.8 in.
DI-TD-24V-80W	b 7.9 in.	2.7 in.	1.8 in.
DI-TD-24V-120W	b 9.1 in.	2.7 in.	1.8 in.

[INDOOR SPEC SHEET](#)
[OUTDOOR SPEC SHEET](#)

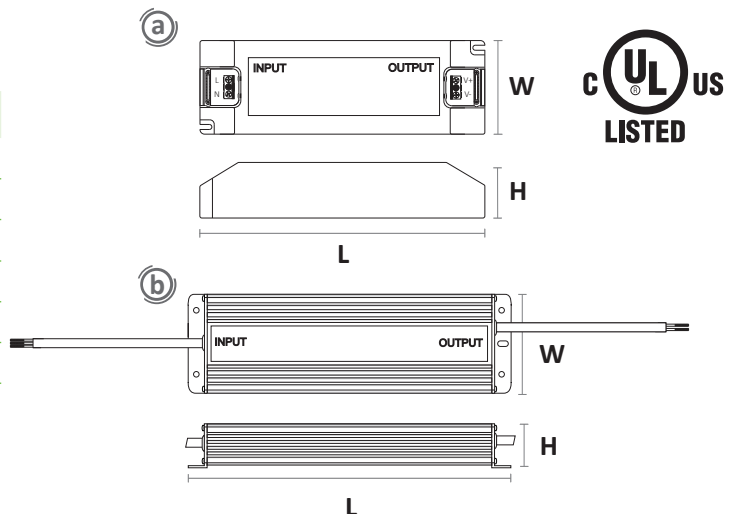

VALENT® X 100/200/300/500/800 – 24V LED Strip Light

SPECIFICATION SHEET

COMPATIBLE PRODUCTS

The following Listed LED Drivers are recommended for compatibility and to meet NEC code when installed according to specifications. For additional LED Driver options see Diode LED's product page at: <https://www.diodeled.com/products/led-power-supplies.html>

OMNIDRIVE® 2 ELECTRONIC DIMMABLE LED DRIVER

OMNIDRIVE 2 features a zero minimum load and 100-5% dimming range. Compatible with Forward Phase and Reverse Phase Dimmers. Please see Diode LED's Compatibility List at: <https://www.diodeled.com/custom/download/productFile/filename/dimmer-master-compatibility-guide.pdf/>

[SPEC SHEET](#)

DI	OD2	Voltage & Power Output 24V24W
----	-----	---

SKU	L - LENGTH	W - WIDTH	H - HEIGHT
DI-OD2-24V24W	13.75 in.	3.00 in.	1.60 in.
DI-OD2-24V60W	13.75 in.	3.00 in.	1.60 in.
DI-OD2-24V96W	15.00 in.	3.10 in.	2.40 in.
DI-OD2-24V120W	15.00 in.	3.10 in.	2.40 in.
DI-OD2-24V200W	16.10 in.	3.40 in.	2.40 in.

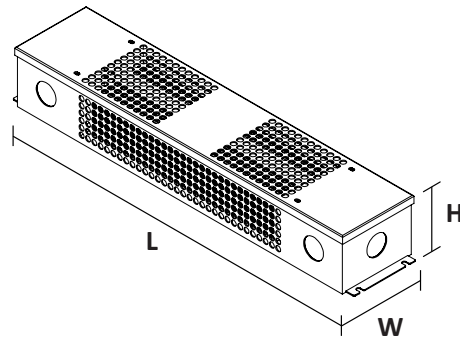

LUTRON OPTIONS

LUTRON® Hi-lume 1% LED DIMMABLE DRIVER

Hi-lume 1% LED Driver has a minimum load of 5W and dims from 100-1%.

DI-DM	Voltage & Power Output 24V40W	3-Wire or 2-Wire Dimmers L3D
-------	---	--

SKU	L - LENGTH	W - WIDTH	H - HEIGHT
DI-DM-24V40W-L3D	4.89 in.	4.00 in.	2.62 in.
DI-DM-24V40W-LTE			

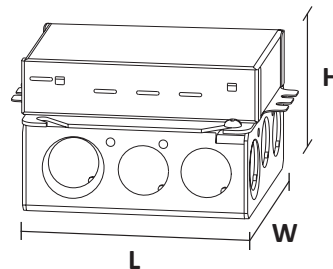

[L3D SPEC SHEET](#)

[LTE SPEC SHEET](#)



LUTRON® Hi-lume Premier 0.1% LED DIMMABLE DRIVER

Hi-Lume Premier 0.1% LED Driver has a minimum load of 5W and dims from 100-0.1%.

DI-DM	Voltage & Power Output 24V96W	L3D
-------	---	------------

SKU	L - LENGTH	W - WIDTH	H - HEIGHT
DI-DM-24V96W-L3D	5.50 in.	2.20 in.	10.50 in.

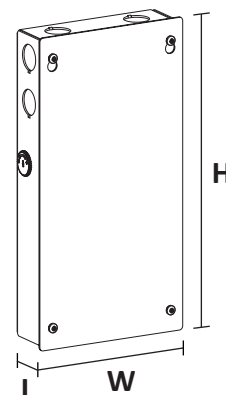

[SPEC SHEET](#)



VALENT® X 100/200/300/500/800 - 24V LED Strip Light

SPECIFICATION SHEET

ACCESSORIES

BUILDER CHANNEL COVERS (individual*) - SLIM / SQUARE / 45° / DUO

SKU	FINISH	FORM FACTOR	BUNDLES	DESCRIPTION
DI-CPCHC-FR48**	Frosted	Frosted Cover (48 in.)	Single or 10 Pack	Protects LED tape light and slightly softens light. Note: there is an average warm shift in Kelvin of 35K and an average 28% decrease in delivered lumens.
DI-CPCHC-FR96**	Frosted	Frosted Cover (96 in.)		
DI-CPCHC-CL48**	Clear	Clear Cover (48 in.)		
DI-CPCHC-CL96**	Clear	Clear Cover (96 in.)		

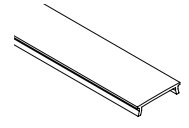

*not for use with Fully Loaded Channels

** - SKUs listed above are for Single covers. Add a -10 for a 10 pack bundle.

BUILDER CHANNEL MOUNTING OPTIONS - SLIM

SKU	FINISH	FORM FACTOR	BUNDLES	DESCRIPTION
DI-1633	N/A	SLIM Mounting Tape (TP)	4 ft. x 0.75 in.	3M® high-bond double-sided adhesive tape designed to install the SLIM channel on a flat, indoor surface.
DI-1634			12 ft. x 0.75 in.	
DI-CPCH-UC-BA DI-CPCH-UC-WH DI-CPCH-UC-BL	AL WH BL	SLIM Mounting U-Clips	Pack of 2 clips / 4 screws	Secure SLIM channel to flat surface with this pressure-fit clip. Also compatible when installed with PREMIUM DIFFUSION cover. Adds 0.12in. height to channel.

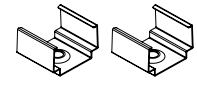

BUILDER CHANNEL MOUNTING OPTIONS - SQUARE / 45° / DUO

SKU	FINISH	FORM FACTOR	BUNDLES	DESCRIPTION
DI-CPMC2-SCR4 DI-1630-20	Steel	Mounting Clips (MTC)	Pack of 2 clips / 4 screws	Secure chto flat surface with this pressure-fit clip. Adds 0.12in. height to channel.
			Pack of 20 clips / 40 screws	
DI-1912	Steel	Vertical Mounting Brackets (VERT)	Pack of 2	Used to install channel in a vertical orientation and includes an Allen key and allen screws for securing to a vertical surface. Note: Mounting Clips, or Rotating Mounting Clips required for installation of Vertical Mounting Brackets.
DI-CPCH-HNG	Steel	Hanging Hardware Kit (HNG)	Pack of 2 hanging mounts / 2 Wire restrainers / 4 screws	Transform your channel into a pendent fixture with the Hanging Hardware Kit.
DI-CPCH-RC-BA DI-CPCH-RC-WH DI-CPCH-RC-BL	AL WH BL	Rotating Mounting Clips (RTC)	Pack of 2 clips / 4 screws	Secure channel to flat surface and adjust to desired angle with this pressure-fit clip. Adds 0.74in. height to channel.

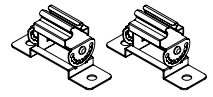
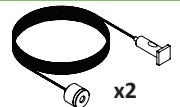
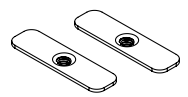
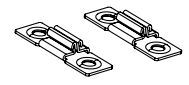

VALENT® X 24" SPLICE CONNECTOR

SKU	MEASUREMENTS	DESCRIPTION
DI-CKT-24SPVX	(.75 x .69 x .25 in) L, W, H	Used to connect to VALENT® X Strip Light to power supply.

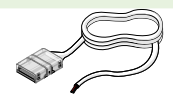

VALENT® X 100/200/300/500/800 – 24V LED Strip Light

SPECIFICATION SHEET

SPECIFICATIONS

- Input: 24VDC Constant Voltage
- LED Chip Type: 2835 GuangMu
- LED Chip Beam Angle: 120°
- Luminous Efficacy³ (lm/w): 109~121
- Mounting: 3M mounting tape on back of tape.
- Connections: 36" female DC lead, and 36" bare lead: 22/2 AWG
- Ambient Temp⁴: -4 - 122°F (-20 ~ 50°C)
- Operating Temp⁵: -4 - 176°F (-20 ~ 80°C)

SPECIFYING?

Note: The compatible products listed in this Specification Sheet are provided for reference only. For complete specifications of compatible products, click on the [SPEC SHEET](#) links provided.

COMPLIANCE & REGULATORY APPROVALS

Safety

- UL Listed 2108 Flexible Lighting Systems. Certified for United States and Canada. File # E469769.

Performance

- Can be used to comply with TITLE 24 Part 6 High efficacy LED requirements - JA8-2016-E
- LED chip data measured in accordance to IES LM-80-08.
- Photometric & Colorimetry data measured in accordance to IES LM-79-08, in Elemental LED's Innovation Lab.

ADDITIONAL INFORMATION

- VALENT® X 24V LED STRIP LIGHT Installation Guide

SAFETY / WARNINGS / DISCLOSURES

1. Install in accordance with national and local electrical code regulations.
2. This product is intended to be installed and serviced by a qualified, licensed electrician.
3. Only install with a listed Class 2 DC Constant Voltage LED Driver.
4. Not for use in or on walls of pools, fountains, or other partially or fully submersed locations.
5. Do not modify or disassemble product beyond instructions or this warranty will be void.
6. Actual color may vary from what is pictured above and on other print materials due to the limitations of photographic processes.
7. We reserve the right to modify and improve the design of our fixtures without prior notice. We cannot guarantee to match existing installed fixtures for subsequent orders or replacements in regards to product appearance, CCT, or lumen output.

WARRANTY

Limited Warranty

This product has a twelve (12) year limited warranty from the date of shipment. This warranty does not include the additional accessories referenced in this specification sheet. Complete warranty details for fixtures and additional accessories are available at www.diodeled.com/limited-warranty/ within the Policies section. For warranty related questions please contact product support.

Consumer's Acknowledgment

Elemental LED, Inc. stands behind its products when they are used properly and according to our specifications. By purchasing our products, the purchaser agrees and acknowledges that lighting design, configuration and installation is a complex process, wherein seemingly minor factors or changes in layout and infield adjustments can have a significant impact on an entire system. Choosing the correct components is essential. Elemental LED is able to work with the original purchaser to make an appropriate product selection to the extent of the limited information that the customer can provide, but it is virtually impossible for Elemental LED to design a system that foresees every unknown factor. For this reason, this Warranty does not cover problems caused by improper design, configuration or installation issues. Any statement from an Elemental LED employee or agent regarding a customer's bill of goods and/or purchase order is NOT an acknowledgment that the products purchased are designed and configured correctly. The purchaser agrees and acknowledges that it is the customer's responsibility to adhere strictly to all information contained in the Product Specification Sheets.

There is often more than one way to design, configure and layout an LED lighting application properly to achieve the same lighting effect. Elemental LED strongly recommends that licensed professionals be used in the design and installation of lighting systems that include Elemental LED products. The specifications include important information that a designer and installer should carefully review and strictly follow. Qualified designers and certified and/or licensed installers, with access to the final installation environment, customer goals, and Elemental LED product specifications can make the requisite decisions appropriate for a successful finished lighting application.



© 2021 Elemental LED, Inc. All rights reserved.
Specifications are subject to change without notice.

Toll Free: 877.817.6028 | Fax: 415.592.1596 | www.DiodeLED.com | info@DiodeLED.com