

**inateck®**

# User Guide

BCST-91 2D Barcode Scanner

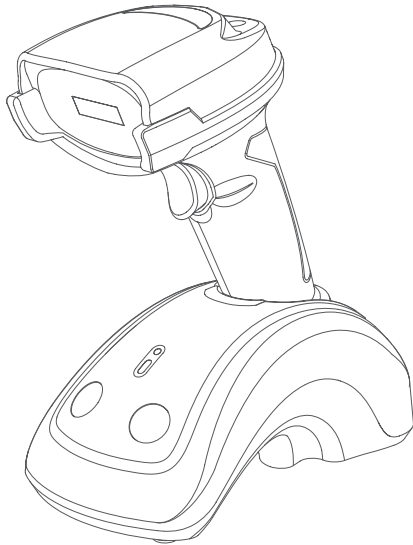

**inateck®**

**Product Illustration / Produktabbildung /  
Product Illustration / Illustrazione del prodotto /  
Ilustración del Producto**

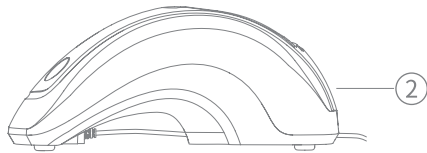
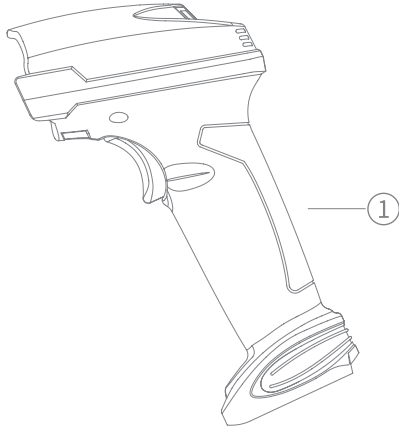

## English

① Base ② USB Cable ③ Barcode Scanner

## Deutsch

① Basis ② USB-Kabel ③ Barcodescanner

## 日本語

①ベース ②USBケーブル ③バーコードスキャナー

## Français

① Base ② Câble d' USB ③ Scanner de codes-barres

## Italiano

① Base ② Cavo USB ③ Scanner di codici a barre

## Español

① Base ② Cable USB ③ Lector de códigos de barra

# Content

<b>1. Quick Start</b>	<b>2</b>
<b>1.1 How to Set up</b>	<b>2</b>
<b>1.2 Button Illustration</b>	<b>2</b>
Button on the Scanner	2
Buttons on the Base	2
<b>1.3 Setting</b>	<b>3</b>
System Setting	3
Keyboard Setting	3
<b>1.4 Frequently Used Barcodes</b>	<b>6</b>
<b>2. Use of BCST-91</b>	<b>10</b>
<b>2.1 Connection</b>	<b>10</b>
Wireless Base Mode	10
Wired Mode	10
Bluetooth Mode(HID)	10
<b>2.2 Charging</b>	<b>10</b>
<b>2.3 Inventory Mode</b>	<b>11</b>
<b>3. Status Indicator</b>	<b>12</b>
<b>4. Product Specification</b>	<b>12</b>
<b>5. Package List</b>	<b>12</b>

## 1. Quick Start

### 1.1 How to Set up

When the base is connected to your computer via USB cable, the LED indicator on the base will turn on, indicating that the base is connected to the computer successfully and can be used as a wireless adapter. When the scanner is placed into the base, the LED indicator on the base will turn to red, indicating that the scanner is connected to the base successfully and can also be charged that way.

Press the scan button, and the barcode scanner will be powered on and connect the base automatically.

### 1.2 Button Illustration

#### Button on the Scanner

**ON:** Press the scan button to turn on the scanner.

**OFF:** Hold the scan button for 2.5 s and the scanner will turn off.

#### Buttons on the Base

**Scan Mode Switch** (⊕): When the scanner is paired with the base, place it into the base and press the button to switch between Auto Sensing Mode and Red Light Auto Off Mode.

**Connection Mode Switch** (⊕): Long press the button for 3s to switch between 2.4G wireless mode and Bluetooth mode.

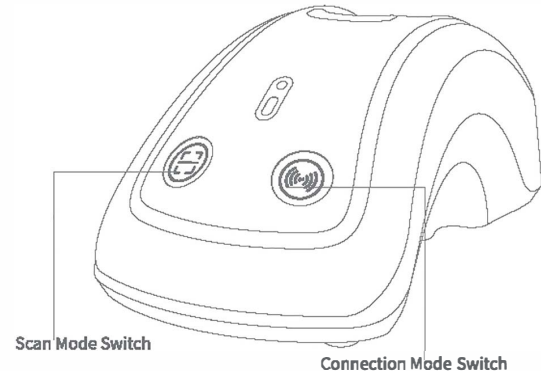

Please feel free to reach out to us if you have any trouble configuring the barcode scanner such as adding/deleting a prefix/suffix. We are always at your service.



Enter Setup

EN EN



Enter Setup

### 1.3 Setting

**Note:**

- 1) Function Setting Steps: [Enter Setup]-[Command barcode (e.g. Low Volume)]-[Save and Exit]
- 2) Those marked with (\*) in the manual indicate default settings.

#### System Setting



(\*) Windows/Android



Mac OS/iOS



French Keyboard



Spanish Keyboard



Italian Keyboard

#### Keyboard Setting



(\*) US Keyboard



German Keyboard



Canadian Keyboard



UK Keyboard



Save and Exit



Quit and Exit



Save and Exit



Quit and Exit



Enter Setup



Enter Setup

EN EN



Japanese Keyboard



Swedish Keyboard



Dutch Keyboard



Danish Keyboard



Norwegian Keyboard

#### 1.4 Frequently Used Barcodes



Factory Reset



(\*) Manual Scanning mode



Auto Sensing Mode



(\*) Enable Auto Sleep



Save and Exit



Quit and Exit



Save and Exit



Quit and Exit



Enter Setup

EN EN



Enter Setup



Disable Auto Sleep



Silent



High Volume



Disable Vibration Alert



Low Volume



(\*Enable Weak Vibration Alert



Enable Strong Vibration Alert



(\* Medium Volume



Convert All Letters into Upper Case



Save and Exit



Quit and Exit



Save and Exit



Quit and Exit



Enter Setup

EN EN



Enter Setup

## 2. Use of BCST-91

### 2.1 Connection

#### (\* Wireless Base Mode

Wireless Base Mode is the default mode. When the base is connected to your computer via USB cable, the LED indicator on the base will turn on, indicating that the base is connected to the computer successfully and can be used as the wireless adapter.

**Note:** If you receive an error when transmitting data in the wireless base mode, please place the scanner into the base and long press the connection mode switching button  to enter wireless base mode and pair the scanner with the base again. You can also scan the command barcodes in sequence to reconnect the scanner with the base: "Enter Setup"——"Wireless Base Mode"——"Save and Exit".



Convert All Letters into Lower Case



(\* Do not Convert Letter Case



(\*Add Enter as Suffix



Use Tab as Suffix



(\*Wireless Base Mode

#### Wired Mode

Connect the scanner with your computer via the USB cable and priority will be given to the USB cable to transmit data even though the scanner was once connected via Bluetooth or the wireless base.

#### Bluetooth Mode(HID)

The Bluetooth mode (HID) is not a default mode. To enter this mode, please long press the connection mode switching button to switch into Bluetooth mode (HID) or scan the command barcodes in sequence: "Enter Setup"- - "Bluetooth Pairing (HID mode)" -- "Save and Exit".



Bluetooth Pairing (HID Mode)

### 2.2 Charging

- 1.Connect the base with a computer/charger via the USB cable and then you can charge the scanner by placing it into the base.
- 2.Connect the scanner with a computer/charger with the included USB cable directly to charge the scanner.



Save and Exit



Quit and Exit



Save and Exit



Quit and Exit

### 2.3 Inventory Mode

Users may use inventory mode to keep the scanned barcodes in the cache of BCST-91 and upload them to a computer in batches. In inventory mode users are not restricted to the time or location when uploading data. In addition, historical data can be cleared in the cache. More details about inventory mode are as below.

**Note:** It is not necessary to scan “Enter Setup” or “Save and Exit” when scanning the 5 barcodes below. Simply scan the barcodes to activate the functions.



Inventory Mode



Clear Data in Cache (for Inventory Mode only)



Upload the Number of Scanned Barcodes (for Inventory Mode only)



(\*)Common Mode



Data Upload (for Inventory Mode only)

EN EN

## 3. Status Indicator

### LED Indication – On the Scanner

Green Light Flashes Once	Data is read and uploaded.
Blue Light Flashes Once	Data is read and stored in buffer.
Steady blue LED	Under setup mode
Flashing red LED	Low battery
Steady red LED	Under Charging (red light off when fully charged)

### LED Indication – On the Base

Green LED	Scanner is fully charged
Red LED	Scanner is in place and under charging
Flashing Blue LED	Wireless pairing or data transmitting
Yellow LED	not in place

## 4. Product Specification

Material	ABS, PC, TPU
Voltage	DC 5V
Battery Capacity	2600 mAh
Supported Barcode	Code 128、EAN-13、EAN-8、UPC-A、UPC-E、Code 39、Code 93、Codabar、Interleaved 2 of 5、Standard 2 of 5、Industrial 2 of 5、Matrix 2 of 5、MSI、Code 11、ISBN、ISSN、GS1 128、GS1 DataBar、GS1 DataBar Expanded、GS1 DataBar Limited、QRCode、PDF-417、Aztec Code、Data Matrix"
Resolution	5mil
Scan Method	Auto/Manually
Lowest Contrast	25%
Decoding Angle	Turning Angle 360° , Elevation Angle 60° , Deflection Angle 70°
Communication Frequency	2.402GHz~2.480GHz

## 5. Package List

BCST-91 \*1  
 USB A to USB C Cable \*1  
 Instruction Manual \*1



# Inhalt

<b>1. Schnellstart</b>	14
<b>1.1 Aufbau</b>	14
<b>1.2 Abbildung der Tasten</b>	14
Tasten am Scanner	14
Tasten an der Basisstation	14
<b>1.3 Einstellungen</b>	15
Systemeinstellungen	15
Tastatursprache	15
<b>1.4 Häufig verwendete Einstellungsbarcodes</b>	18
<b>2. Verwendung von BCST-91</b>	22
<b>2.1 Verbindung</b>	22
Funkverbindung zur Basis	22
Kabelmodus	22
Bluetooth-Modus (HID)	22
<b>2.2 Laden</b>	22
<b>2.3 Inventurmodus</b>	23
<b>3. LED-Statusanzeige</b>	24
<b>4. Produktspezifikationen</b>	24
<b>5. Packungsinhalt</b>	24

Wenn Sie Probleme bei der Konfiguration Ihres Barcodescanners haben, z. B. beim Hinzufügen/Löschen eines Präfixes/Suffixes, können Sie sich gerne an uns wenden. Wir sind immer für Sie da.

## 1. Schnellstart

### 1.1 Aufbau

Wenn die Basisstation über ein USB-Kabel mit Ihrem Computer verbunden ist, leuchtet die LED-Anzeige an der Basisstation auf und zeigt damit an, dass die Basisstation erfolgreich mit dem Computer verbunden ist und als Funkadapter verwendet werden kann. Wenn der Scanner in die Basis gestellt wird, leuchtet die LED-Anzeige an der Basis rot auf und zeigt damit an, dass der Scanner erfolgreich mit der Basis verbunden ist und auf diese Weise auch aufgeladen werden kann.

Press the scan button, and the barcode scanner will be powered on and connect the base automatically.

### 1.2 Abbildung der Tasten

#### Tasten am Scanner

EIN: Drücken Sie die Scan-Taste, um den Scanner einzuschalten.

AUS: Halten Sie die Scantaste 2,5 s lang gedrückt, und der Scanner schaltet sich nach aus.

#### Tasten an der Basisstation

Scan-Modus wechseln (☺) : Wenn der Scanner mit der Basis gepaart ist, setzen Sie ihn in die Basis ein und drücken Sie die Taste, um zwischen dem automatischen Erkennungsmodus und dem automatischen Rotlicht-Ausschaltmodus zu wechseln.

Umschalten des Verbindungsmodus (☺) : Drücken Sie die Taste 3 Sekunden lang, um zwischen dem drahtlosen 2.4G-Modus und dem Bluetooth-Modus zu wechseln.

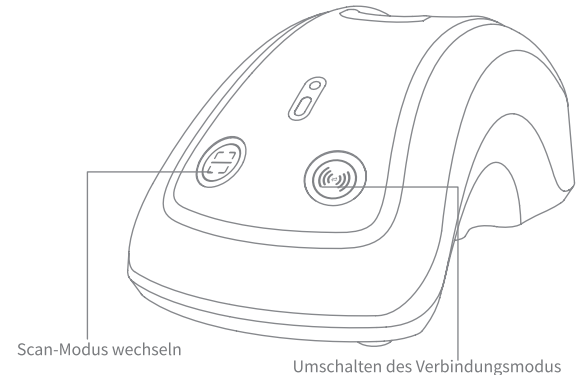



Beginn der Einrichtung

### 1.3 Einstellungen

**Hinweis:**

- 1) Schritte zum Vornehmen von Einstellungen: "Beginn der Einrichtung"- "Einstellungsbarcode (z.B.: Lautstärke niedrig)"—"Speichern und Beenden".
- 2) Die mit (\*) markierten Einstellungsbarcodes zeigen die Werkseinstellung an.

#### Systemeinstellungen



(\*) Windows/Android



Mac OS/iOS

#### Tastatursprache



(\*) US Tastatur



Deutsche Tastatur

DE DE



Französische Tastatur



Spanische Tastatur



Italienische Tastatur



UK Tastatur



Kanadische Tastatur



Speichern und Beenden



Beenden ohne Speichern



Beginn der Einrichtung



Speichern und Beenden



Beenden ohne Speichern



Beginn der Einrichtung



Japanische Tastatur



Niederländische Tastatur



Norwegische Tastatur



Schwedische Tastatur



Dänische Tastatur



Speichern und Beenden



Beenden ohne Speichern



Beginn der Einrichtung

#### 1.4 Häufig verwendete Einstellungsbarcodes

DE DE



Auf Werkseinstellung zurücksetzen



Automatischen Erkennungsmodus



(\*) Manueller Scan-Modus



(\*) Auto-Ruhemodus einschalten



Speichern und Beenden



Beenden ohne Speichern



Beginn der Einrichtung



Auto-Ruhemodus ausschalten



Lautstärke niedrig



Stummschalten



(\*) Lautstärke mittel

DE DE



Lautstärke hoch



(\*) Vibrationsalarm einschalten schwach



Alle Buchstaben in Großbuchstaben umwandeln



Vibrationsalarm ausschalten



Vibrationsalarm einschalten stark



Speichern und Beenden



Beenden ohne Speichern



Beginn der Einrichtung



Speichern und Beenden



Beenden ohne Speichern



Beginn der Einrichtung



Alle Buchstaben in Kleinbuchstaben umwandeln



(\*)Enter als Suffix



(\*) Groß-/Kleinbuchstaben nicht umwandeln



Tab als Suffix

DE DE



Speichern und Beenden



Beenden ohne Speichern



Beginn der Einrichtung

## 2. Verwendung von BCST-91

### 2.1 Verbindung

#### (\* Funkverbindung zur Basis

Der drahtlose Basismodus ist der Standardmodus. Wenn die Basisstation über ein USB-Kabel mit Ihrem Computer verbunden ist, leuchtet die LED-Anzeige an der Basisstation auf und zeigt damit an, dass die Basisstation erfolgreich mit dem Computer verbunden ist und als drahtloser Adapter verwendet werden kann.

**Hinweis:** Wenn bei der Datenübertragung im drahtlosen Basismodus ein Fehler auftritt, setzen Sie den Scanner in die Basis ein und drücken Sie lange auf die Taste  zum Umschalten des Verbindungsmodus, um den drahtlosen Basismodus aufzurufen und den Scanner erneut mit der Basis zu koppeln. Sie können auch die folgenden Einstellungsbarcodes nacheinander scannen, um den Scanner wieder mit der Basis zu verbinden: "Beginn der Einrichtung" -- "Kabellose Basisstation" -- "Speichern und Beenden".



Funkverbindung zur Basis

#### Kabelmodus

Schließen Sie den Scanner über das USB-Kabel an einen Computer an. BCST-91 überträgt Daten dann bevorzugt über das USB-Kabel an den Computer, auch wenn vorher die Verbindung über Bluetooth oder Basisstation genutzt wurde.

#### Bluetooth-Modus (HID)

Der Bluetooth-Modus (HID) ist nicht der Standardmodus. Um diesen Modus aufzurufen, drücken Sie bitte lange auf die Taste zum Umschalten des Verbindungsmodus, um in den Bluetooth-Modus (HID) zu wechseln. Alternativ können Sie um das zu tun auch nacheinander die Einstellungsbarcodes: "Beginn der Einrichtung" - "Bluetooth Kopplung (HID-Modus)" -- "Speichern und Beenden" scannen.



Bluetooth-Kopplung (HID-Modus)

### 2.2 Laden

1. Verbinden Sie die Basisstation über das USB-Kabel mit einem Computer/Ladegerät und laden Sie den Scanner auf, indem Sie ihn in die Basisstation stellen.

2. schließen Sie den Scanner über das mitgelieferte USB-Kabel direkt an einen Computer/Ladegerät an, um ihn aufzuladen.



Speichern und Beenden



Beenden ohne Speichern

### 2.3 Inventurmodus

Im Inventurmodus können gescannte Barcodes im Zwischenspeicher des Scanners gespeichert werden und stapelweise auf einen Computer hochladen. Im Inventurmodus sind Benutzer beim Hochladen der Daten nicht an die Zeit oder den Ort gebunden. Darüber hinaus können historische Daten aus dem Cache gelöscht werden. Weitere Einzelheiten zum Inventurmodus finden Sie im Folgenden.

Hinweis: Es ist nicht notwendig, "Beginn der Einrichtung" oder "Speichern und Beenden" zu scannen, wenn Sie die 5 Barcodes folgendes Barcodes scannen. Scannen Sie einfach die Barcodes, um die Funktionen zu aktivieren.



Inventurmodus



(\*)Normalmodus



Daten im Cache löschen (Nur für Inventurmodus)



Daten hochladen (Nur für Inventurmodus)



Anzahl der gescannten Barcodes ausgeben (Nur für Inventurmodus)

DE DE

## 3. LED-Statusanzeige

### LED-Anzeige – Auf dem Scanner

Grüne LED blinkt einmal auf	Daten eingelesen und übertragen
Blaue LED blinkt einmal auf	Daten eingelesen und im Cache gespeichert.
Blaue LED leuchtet durchgängig	Scanner befindet sich im Einrichtungsmodus
Rote LED blinkt	Niedriger Akkuladestatus
Rote LED leuchtet durchgängig	Wird geladen (Rote LED schaltet sich bei vollständiger Aufladung aus)

### LED-Anzeige – An der Basisstation

Grüne LED	Scanner vollständig geladen
Rote LED	Scanner wird geladen
Blaue LED blinkt	Kopplung oder Datenübertragung findet statt
Gelbe LED	nicht in der Basisstation

## 4. Produktspezifikationen

Material	ABS, PC, TPU
Spannung	DC 5V
Akkukapazität	2600 mAh
Unterstützte Barcodetypen	Code 128, EAN-13, EAN-8, UPC-A, UPC-E, Code 39, Code 93, Codabar, Interleaved 2 of 5, Standard 2 of 5, Industrial 2 of 5, Matrix 2 of 5, MSI, Code 11, ISBN, ISSN, GS1 128, GS1 DataBar, GS1 DataBar Expanded, GS1 DataBar Limited, QRCode, PDF-417, Aztec Code, Data Matrix"
Auflösung	3 mil
Scan-Methode	Automatisch/Manuell
Niedrigster Kontrast	20%
Dekodierwinkel	Turning 30°, Elevation 75°, Deflection 80°
Kommunikationsfrequenz	2.402GHz~2.480GHz

## 5. Packungsinhalt

BCST-91 \*1  
 USB-A zu USB-C-Kabel \*1  
 Bedienungsanleitung \*1

## コンテンツ

1. 快速開始	26
1.1 設定方法	26
1.2 ボタン図	26
スキャナーのボタン	26
ベースのボタン	26
1.3 設定	27
システム設定	27
キーボード設定	27
1.4 よく使うバーコード	28
2. BCST-91 の使い方	34
2.1 接続する	34
無線ベースモード	34
有線接続モード	34
Bluetooth モード (HID)	34
2.2 充電	34
2.3 在庫モード	35
3. LED インジケーター	36
4. 製品パラメータ	36
5. パッケージリスト	36

プレフィックス / サフィックスの追加や削除等機能設定については、ご不明点等がございましたら、弊社のカスタマーサポート窓口にお問い合わせください。ご満足いただけるようご問題の解決に全力を尽くす所存でございます。

## 1. 使い始め

### 1.1 設定方法

付属の USB ケーブルの経由にてベースをコンピューターに接続します。接続が完了すると、ベースの LED インジケータが点灯し、ワイヤレスアダプターとして使用できます。スキャナーをベースに置き、ベースの赤い LED が点灯して、スキャナーがベースに正常に接続され、スキャナー本体を充電することができます。

トリガーを押すと、バーコードスキャナーがオンになり、ベースが自動的に接続されます。

### 1.2 ボタン図

スキャナーのボタン

ON: 1 回押すと、電源が入ります。

OFF: 2.5 秒間長押しすると、スキャナーは、電源が切れます。

ベースのボタン

スキャンモードスイッチ (S): ベースとペアリング済みの場合は、スキャナーはベースに置いてこのボタンを押すと、自動感知モードとスキャンライト自動オフモードの2つのモードの間に切り替えます。

接続モードの切り替え (R): ボタンを 3 秒長押しすると、2.4G 無線モードと Bluetooth モードを切り替えることができます。

JP JP

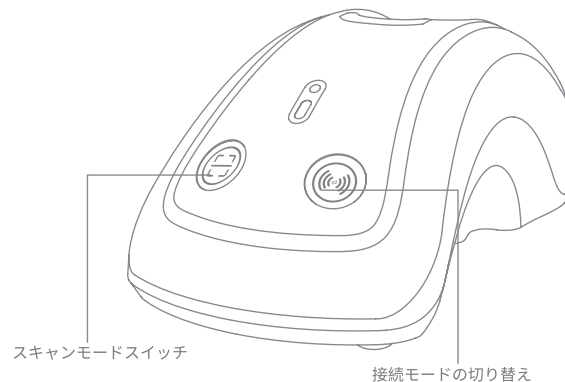

スキャンモードスイッチ

接続モードの切り替え



セットアップ

### 1.3 設定

#### ご注意:

1. 機能設定の流れ: "セットアップ" —— "例えば: 低音量" —— "保存して終了"
2. 出荷時のデフォルト設定は、「\*」で示されています。

#### システム設定



(\*) Windows/Android



Mac OS/iOS

JP JP



スペイン語キーボード



イタリア語キーボード

#### キーボード設定



(\*) US キーボード



ドイツ語キーボード



カナダ語キーボード



UK キーボード



保存して終了



保存せずに終了



保存して終了



保存せずに終了





セットアップ



日本語キーボード



オランダ語キーボード



ノルウェー語キーボード



スウェーデン語キーボード



デンマーク語キーボード



セットアップ

#### 1.4 よく使うバーコード



工場出荷時の設定に戻す



自動感知モード



(\*) 手動スキャン モード



(\*) 自動スリープを有効する



保存して終了



保存せずに終了



保存して終了



保存せずに終了



セットアップ



自動スリープを無効する



低音量



ミュート

JP JP



(\* 中音量



高音量



(\* 振動アラート (弱) を有効にする



振動アラートを無効する



振動アラート (強) を有効にする



すべての文字を大文字に変換する



保存して終了



保存せずに終了



セットアップ



保存して終了



保存せずに終了



セットアップ



すべての文字を小文字に変換する



(\*) サフィックスとして Enter を追加



(\*) 大文字と小文字を変換しない



サフィックスとして Tab を追加



保存して終了



保存せずに終了



セットアップ

## 2. BCST-91 の使い方

### 2.1 接続する

(\*) 無線ベースモード

無線ベースモードはデフォルトの接続モードです。付属の USB ケーブルの経路にてベースをコンピューターに接続します。接続が完了すると、ベースの LED インジケータが点灯し、ワイヤレスアダプターとして使用できます。

ご注意：無線ベースモードでデータ転送中にエラーが発生した場合は、スキャナーをベースに置き、接続モード切り替えボタン(Ⓜ)を長押しして、ワイヤレスベースモードに入り、再びスキャナーをベースとペアリングしてください。下記の順番に従って設定バーコードをスキャンして、スキャナーをベースに再接続することもできます。「セットアップ」-「無線ベースモード」-「保存して終了」。



無線ベースモード

有線接続モード

USB ケーブルを介してスキャナーをコンピューターに接続します。有線接続の場合は、無線ベースまたは Bluetooth 経路で動作したことがあっても、優先に USB ケーブル経路でコンピューターにデータを送信します。

Bluetooth モード (HID)

Bluetooth モード (HID) はデフォルトモードではありません。このモードに入るには、接続モード切り替えボタンを長押しして、Bluetooth モード (HID) モードに切り替わります。

或いは下記の順番に従って設定バーコードをスキャンしてください。「セットアップ」-「Bluetooth ペアリング (HID モード)」-「保存して終了」。



Bluetooth ペアリング (HID モード)

### 2.2 充電

1. 付属の USB ケーブルを介してベースをコンピューター / 充電アダプターに接続します。スキャナーをベースに置いて充電し始めます。
2. 付属の USB ケーブルを介してスキャナーをコンピューター / 充電アダプターに直接接続して充電します。



保存して終了



保存せずに終了

### 2.3 在庫モード

在庫モードでは、読み取ったバーコードをバッファに保存してコンピュータやタブレットに一括アップロードすることができます。在庫モードでは、データをアップロードする時間と場所に制限されません。アップロード後に履歴データをバッファでクリアすることができます。在庫モードの詳細は次のとおりです。

ご注意：以下の5つのバーコードをスキャンする場合、「セットアップ」または「保存して終了」をスキャンする必要はありません。該当バーコードをスキャンするだけで機能が有効になります。



在庫モード



バッファ内のデータをクリアする（在庫モードのみ）



読み取ったバーコードの数量をアップロードする（在庫モードのみ）



(\*) 通常モード



データをアップロードする（在庫モードのみ）

JP JP

## 3. LED インジケータ

### LED インジケータ - スキャナー本体

緑色のLEDが一回点滅した	バーコードが正常に読み取られ、コンピュータにアップロードされました。
青色のLEDが一回点滅した	バーコードは正常に読み取られ、バッファに保存されました。
青色のLEDが常時点灯している	セットアップモード
赤色のLEDが点滅	ローバッテリー
赤色のLEDが常時点灯している	充電中（満充電になると赤色のLEDが消灯します。）

### LED インジケータ - ベース

緑色	満充電になる
赤色	スキャナーは所定の位置にあり、充電しています。
青点滅	ペアリングしているか、データを転送しています。
黄色のLED	スキャナーが所定の位置にありません

## 4. 製品パラメータ

材料	ABS, PC, TPU
定格電圧	DC 5V
バッテリー容量	2600 mAh
対応バーコード	Code 128、EAN-13、EAN-8、UPC-A、UPC-E、Code 39、Code 93、Codabar、Interleaved 2 of 5、Standard 2 of 5、Industrial 2 of 5、Matrix 2 of 5、MSI、Code 11、ISBN、ISSN、GS1 128、GS1 DataBar、GS1 DataBar Expanded、GS1 DataBar Limited、QRCode、PDF-417、Aztec Code、Data Matrix"
読み取り精度	3 mil
スキャン方式	自動 / 手動
最低コントラスト	20%
デコード角度	回転角度 30°、仰角 75°、たわみ角度 80°
通信周波数	2.402GHz~2.480GHz

## 5. パッケージリスト

BCST-91 \*1  
USB A -USB C ケーブル \*1  
取扱説明書 \* 1

# Contenu

<b>1. Démarrage Rapide</b>	38
1.1 Comment configurer	38
1.2 Illustration des boutons	38
Bouton sur le scanner	38
Boutons sur la Base	38
1.3 Configurations	39
Configurations du système d'opération	39
Configuration du clavier	39
1.4 Codes-Barres Utilisés Fréquemment	42
<b>2. Fonctions de BCST-91</b>	46
2.1 Modes de Connexion	46
Mode Base Sans Fil	46
Mode Filaire	46
Mode Bluetooth(HID)	46
2.2 Chargement	46
2.3 IMode d' Inventaire	47
<b>3. Indication LED</b>	48
<b>4. Spécification du produit</b>	48
<b>5. Dans l' emballage</b>	48

N'hésitez pas à nous contacter si vous avez des difficultés à configurer votre scanner de codes-barres, comme l'ajout/la suppression d'un préfixe/suffixe. Nous sommes toujours à votre disposition

## 1. Démarrage Rapide

### 1.1 Comment configurer

Lorsque la base est connectée à votre ordinateur via un câble USB, l'indicateur LED sur la base s'allume, indiquant que la base est connectée à l'ordinateur avec succès et peut être utilisée comme un adaptateur sans fil. Lorsque le scanner est placé dans la base, l'indicateur LED de la base devient rouge, ce qui indique que le scanner est correctement connecté à la base et qu'il peut être rechargé de cette manière.

Appuyez sur le bouton de scanner, le scanner de codes-barres s'allume et se connecte automatiquement à la base.

### 1.2 Illustration des boutons

#### Bouton sur le scanner

ON: Appuyez sur le bouton de scannage pour activer le scanner.

OFF: Maintenez le bouton de scannage pendant 2,5 s et le scanner s'éteint.

#### Boutons sur la Base

Changement de mode de scannage (☺) : Lorsque le scanner est apparié avec la base, placez-le sur la base et appuyez sur le bouton pour passer du mode de détection automatique au mode d'arrêt automatique du laser.

Changement de mode de connexion (📶) : appuyez longuement sur le bouton pendant 3 secondes pour passer du mode sans fil 2.4G au mode Bluetooth.

FR FR

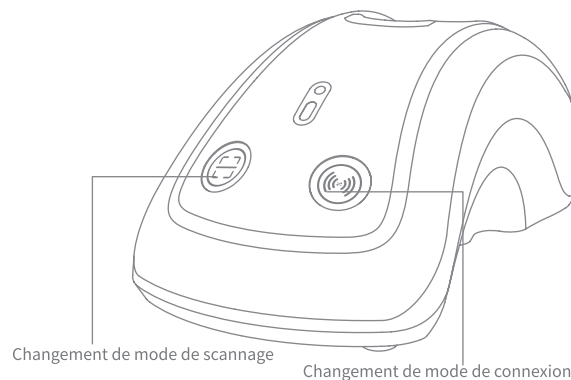



Entrer les configurations

### 1.3 Configurations

**Note:**

- 1) Étapes de configuration des fonctions : " Entrer la configuration " -" Code-barres de Commande (ex : Volume Faible)" -" Enregistrer avec Quitter "
- 2) La configuration d' usine par défaut est remarquée par un astérisque « \* ».

#### Configurations du système d' opération



(\*) Windows/Android



Mac OS/iOS

#### Configuration du clavier



(\*) Clavier de l' États Unis



Clavier de l' Allemagne



Clavier de la France



Clavier de l' Espagnol



Clavier de l' Italie



Clavier de l' Angleterre



Clavier du Canada



Quitter avec enregistrement



Quitter sans enregistrement



Entrer les configurations



Quitter avec enregistrement



Quitter sans enregistrement



Entrer les configurations



Entrer les configurations



Clavier du Japon



Clavier de la Suède



Clavier de la Hollande



Clavier du Danemark



Clavier de la Norvège



#### 1.4 Codes-Barres Utilisés Fréquemment



Restaurer les configurations  
d' usine



(\*) Mode de Scan Manuel



Mode de détection  
automatique



(\*) Activer le mode auto-veille



Quitter avec enregistrement



Quitter sans enregistrement



Quitter avec enregistrement



Quitter sans enregistrement



Entrer les configurations



Désactiver le mode auto-veille



Volume minimal



Muet



(\*) Volume moyen

FR FR



Entrer les configurations



Volume maximal



(\*) Activer l'alerte par vibrations faibles



Désactiver l'alerte par vibrations



Activer l'alerte par vibrations fortes



Lettre majuscules pour toutes les lettres



Quitter avec enregistrement

43



Quitter sans enregistrement



Quitter avec enregistrement

44



Quitter sans enregistrement





Entrer les configurations



Lettre minuscule pour toutes les lettres



(\*) Ajouter Enter comme suffixe



(\*) Ne pas modifier la casse des lettres du codes à barres



Appliquer «Tab» comme Suffixe



Quitter avec enregistrement



Quitter sans enregistrement



Entrer les configurations

## 2. Fonctions de BCST-91

### 2.1 Modes de Connexion

#### (\* Mode Base Sans Fil

Le mode Base sans fil est le mode par défaut. Lorsque la base est connectée à votre ordinateur via un câble USB, l'indicateur LED de la base s'allume, indiquant que la base est connectée à l'ordinateur avec succès et qu'elle peut être utilisée comme adaptateur sans fil.

**Note:** Si vous recevez une erreur lors de la transmission de données en mode base sans fil, placez le scanner dans la base et appuyez longuement sur le bouton  de changement de mode de connexion pour passer en mode base sans fil et apparaître à nouveau le scanner avec la base. Vous pouvez également scanner les codes-barres de commande en séquence pour reconnecter le scanner à la base : "Entrer les Configurations" - " Mode Base Sans Fil " - " Quitter avec Enregistrement ".



Mode Base Sans Fil

#### Mode Filaire

Connectez le scanner à votre ordinateur via le câble USB et la priorité sera donnée au câble USB pour transmettre les données, même si le scanner a été connecté via Bluetooth ou la base sans fil.

#### Mode Bluetooth (HID)

Le mode Bluetooth (HID) n'est pas un mode par défaut. Pour entrer dans ce mode, appuyez longuement sur le bouton de changement de mode de connexion pour passer en mode Bluetooth (HID) ou scannez les codes-barres de commande en séquence : "Entrer les Configurations"--" Appairage Bluetooth ( Mode HID)"--"Quitter avec Enregistrement".



Appairage Bluetooth (Mode HID)

### 2.2 Chargement

- 1.Connectez la base à un ordinateur/chargeur via le câble USB et vous pouvez ensuite charger le scanner en le plaçant dans la base.
- 2.Connectez le scanner à votre ordinateur/un secteur d' alimentation par le câble d' USB directement pour le recharger.



Quitter avec enregistrement



Quitter sans enregistrement

### 2.3 IMode d' Inventaire

Sous le mode d' Inventaire, vous pouvez garder les codes-barres scannés dans le cache de scanner et télécharger des données à un ordinateur/appareil mobile par lots. En ce mode, les utilisateurs ne sont pas limités par le temps ou la location lors de télécharger les données. En outre, vous pouvez effacer des données par la configuration ci-dessous. Plus d' informations se trouvent comme suit.

Note: Il n'est pas nécessaire de scanner " Entrer les Configurations " ou " Quitter avec Enregistrement " lorsque vous scannez les 5 code-barres ci-dessous. Pour scanner les codes barres correspondantes ci-dessous pour activer la fonction



Mode d' Inventaire



(\*)Mode Commun



Effacer des données  
(En mode d' inventaire  
seulement)



Télécharger des données  
(En mode d' inventaire  
seulement)



Télécharger le nombre  
de codes-barres scannés  
(En mode d' inventaire  
seulement)



### 3. Indication LED

État des indicateurs - sur le scanner	
LED vert clignote une fois	Les données sont lues et téléchargées.
LED bleu clignote une fois	Code-barres scannés et enregistré dans le cache avec succès, mais pas téléchargés à l' ordinateur.
LED bleu continue	En mode configuration
LED rouge clignotant	Batterie faible
LED rouge continue	Scanner en charge (LED rouge s'éteint quand la batterie est pleine)

États des indicateurs - sur la base	
LED Vert	Le scanner est en pleine charge
LED Rouge	Le scanner codes-barres est chargé par le support
LED bleu clignotant	Appairage sans fil ou transmission de données
LED jaune	n'est pas en place

### 4. Spécification du produit

Material	ABS, PC, TPU
Voltage	DC 5V
Capacité de la batterie	2600 mAh
Codes-Barres Applicables	Code 128, EAN-13, EAN-8, UPC-A, UPC-E, Code 39, Code 93, Codabar, Interleaved 2 of 5, Standard 2 of 5, Industrial 2 of 5, Matrix 2 of 5, MSI, Code 11, ISBN, ISSN, GS1 128, GS1 DataBar, GS1 DataBar Expanded, GS1 DataBar Limited, QRCode, PDF-417, Aztec Code, Data Matrix"
Résolution	3 mil
Mode de Scan	Auto/Manual
Contraste d' Impression	20%
Angle de décodage	L' angle de rotation 30°, L' angle d' altitude 75°, L' angle de déviation 80°
Fréquence de Radio	2.402GHz~2.480GHz

### 5. Dans l' emballage

BCST-91 \*1  
Câble USB A vers USB C \*1  
Mode d'emploi \*1

# Contenuti

<b>1. Avvio rapido</b>	50
1.1 Come configurare	50
1.2 Illustrazione dei pulsanti	50
Pulsante sullo scanner	50
Pulsanti sulla base	50
1.3 Impostazioni	51
Impostazioni di sistema	51
Impostazioni della tastiera	51
1.4 Codici a barre frequenti	54
<b>2. Usi del BCST-91</b>	58
2.1 Connessione	58
Modalità base Wireless	58
Modalità cavo	58
Modalità Bluetooth (HID)	58
2.2 Carica	58
2.3 Modalità inventario	59
<b>3. Indicazioni LED</b>	60
<b>4. Specifiche del prodotto</b>	60
<b>5. Contenuto della confezione</b>	60

Non esitate a contattarci in caso di problemi di configurazione dello scanner di codici a barre, come l'aggiunta/eliminazione di un prefisso/suffisso. Siamo sempre a vostra disposizione

## 1. Avvio rapido

### 1.1 Come configurare

Quando la base è collegata al computer tramite cavo USB, l'indicatore LED sulla base si accende, indicando che la base è collegata al computer e può essere utilizzata come adattatore wireless. Quando lo scanner viene inserito nella base, l'indicatore LED sulla base diventa rosso, indicando che lo scanner è collegato alla base e può essere caricato.

Premendo il pulsante di scansione, lo scanner di codici a barre si accenderà e si collegherà automaticamente alla base.

### 1.2 Illustrazione dei pulsanti

#### Pulsante sullo scanner

ON: premere il pulsante di scansione per accendere lo scanner.

OFF: tenere premuto il pulsante di scansione per 2,5 s e lo scanner si spegnerà.

#### Pulsanti sulla base

Interruttore della modalità di scansione : Quando lo scanner è accoppiato alla base, inserirlo nella base e premere il pulsante per passare dalla modalità di rilevamento automatico alla modalità di spegnimento automatico della luce rossa.

Commutazione della modalità di connessione : premere a lungo il pulsante per 3 secondi per passare dalla modalità wireless 2.4G alla modalità Bluetooth.

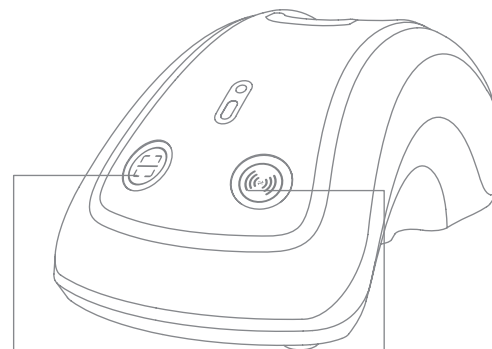

Interruttore della modalità di scansione

Commutazione della modalità di connessione





### 1.3 Impostazioni

**Nota:**

- 1) Fasi di impostazione delle funzioni: "Entrare nella configurazione"- " Comando del codice a barre (ad es.: Volume basso)"-"Salva ed esci".
- 2) Quelle contrassegnate con (\*) nel manuale indicano le impostazioni predefinite.

#### Impostazioni di sistema



(\*) Windows/Android



Mac OS/iOS

#### Impostazioni della tastiera



(\*) Tastiera US



Tastiera Tedesca



Tastiera Francese



Tastiera Spagnola



Tastiera Italiana



Tastiera UK



Tastiera Canadese



Tastiera Francese



Tastiera Spagnola



Tastiera Italiana



Tastiera UK



Tastiera Canadese





Tastiera Giapponese



Tastiera Olandese



Tastiera Norvegese



Tastiera Svedese



Tastiera Danese



#### 1.4 Codici a barre frequenti



Reset impostazioni di fabbrica



Modalità di rilevamento automatico



(\*) Modalità lettura manuale



(\*) Abilita auto riposo





Beginn der Einrichtung



(\*) Disabilita auto riposo



Basso volume



Silenzioso



(\*) Medio volume

IT IT



Beginn der Einrichtung



Alto Volume



(\*) Abilita vibrazione debole



Disabilita vibrazione



Abilita vibrazione forte



Trasforma tutte le lettere in maiuscole



Speichern und Beenden



Beenden ohne Speichern



Speichern und Beenden



Beenden ohne Speichern



Beginn der Einrichtung



Trasforma tutte le lettere in minuscole



(\*)Aggiungi Invio come suffisso



(\*) Non trasformare le lettere



Utilizza Tab come suffisso



Speichern und Beenden



Beenden ohne Speichern



Beginn der Einrichtung

## 2. Usi del BCST-91

### 2.1 Connessione

(\*)Modalità base Wireless

La modalità Base wireless è la modalità predefinita. Quando la base è collegata al computer tramite cavo USB, l'indicatore LED sulla base si accende, indicando che la base è collegata al computer e può essere utilizzata come adattatore wireless.

**Nota:** se si verifica un errore durante la trasmissione dei dati in modalità base wireless, inserire lo scanner nella base e premere a lungo il pulsante  di commutazione della modalità di connessione per accedere alla modalità base wireless e accoppiare nuovamente lo scanner con la base. È anche possibile scansionare i codici a barre di comando in sequenza per ricollegare lo scanner alla base: " Inserisci impostazione" -- "Modalità base wireless" -- "Salva ed esci".



Modalità base Wireless

Modalità cavo

Collegando lo scanner al computer tramite il cavo USB, verrà data priorità al cavo USB per la trasmissione dei dati, anche se lo scanner è stato collegato tramite Bluetooth o la base wireless.

Modalità Bluetooth (HID)

La modalità Bluetooth (HID) non è una modalità predefinita. Per accedere a questa modalità, premere a lungo il pulsante di commutazione della modalità di connessione per passare alla modalità Bluetooth (HID) o scansionare i codici a barre di comando in sequenza: "Enter Setup" -- "Bluetooth Pairing (HID mode)" -- "Save and Exit".



Accoppiamento Bluetooth (HID)

### 2.2 Carica

1.Collegare la base a un computer/caricabatterie tramite il cavo USB e poi caricare lo scanner inserendolo nella base.

2.Collegare lo scanner a un computer/caricabatterie tramite il cavo USB in dotazione per caricare direttamente lo scanner.



Speichern und Beenden



Beenden ohne Speichern

### 2.3 Modalità Inventario

Gli utenti possono utilizzare la modalità inventario per conservare i codici a barre scansionati nella cache dello scanner e caricarli su un computer in batch. In modalità inventario, gli utenti non sono vincolati all'ora o al luogo di caricamento dei dati. Inoltre, i dati storici possono essere cancellati dalla cache. Di seguito sono riportati ulteriori dettagli sulla modalità inventario.

**Nota:** Non è necessario eseguire la scansione di "Impostazioni" o "Salva ed Esci" quando si scansionano i 5 codici a barre sottostanti. È sufficiente scansionare i codici a barre per attivare le funzioni.



Modalità inventario



Cancella dati nella Cache (solo per modalità inventario)



Carica il numero di codici scansionati (solo per modalità inventario)



(\*)Modalità comune



Carica dati (solo per modalità inventario)



### 3. Indicazioni LED

Stato dell'indicatore - sul lettore	
LED verde lampeggia una volta	I dati sono letti e caricati.
LED blu lampeggia una volta	I dati sono letti e caricati nel buffer
LED blu fisso	Modalità setup
Luce rossa lampeggiante	batteria scarica
Luce rossa fissa	Sottocarica (luce rossa spenta quando è completamente carica)

Stato dell'indicatore - sulla base	
LED verde	Lo scanner è completamente carico
LED rosso	Lo scanner è in posizione ed è sottocarica
LED lampeggiante blu	Accoppiamento wireless o invio dati
LED giallo	non in posizione

### 4. Specifiche del prodotto

Materiale	ABS, PC, TPU
Voltaggio	DC 5V
Capacità batteria	2600 mAh
Codici a barre supportati	Code 128, EAN-13, EAN-8, UPC-A, UPC-E, Code 39, Code 93, Codabar, Interleaved 2 of 5, Standard 2 of 5, Industrial 2 of 5, Matrix 2 of 5, MSI, Code 11, ISBN, ISSN, GS1 128, GS1 DataBar, GS1 DataBar Expanded, GS1 DataBar Limited, QRCode, PDF-417, Aztec Code, Data Matrix"
Risoluzione	3 mil
Metodo di scansione	Auto/Manuale
Contrasto più basso	20%
Angolo di decodifica	Angolo di sterzata 30°, angolo di elevazione 75°, angolo di deviazione 80°.
Frequenza di comunicazione	2.402GHz~2.480GHz

### 5. Contenuto della scatola

BCST-91 \*1  
Cavo da USB A a USB C \*1  
Manuale d'istruzioni \*1



# Contenido

<b>1. Inicio Rápido</b>	62
<b>1.1 Cómo configurar</b>	62
<b>1.2 Ilustración de los botones</b>	62
Botón del lector	62
Botones de la base	62
<b>1.3 Configuración</b>	63
Configuración del sistema	63
Configuración del teclado	63
<b>1.4 Códigos de barra de uso frecuente</b>	66
<b>2. Uso del BCST-91</b>	70
<b>2.1 Conexión</b>	70
Modo de base inalámbrica	70
Modo de conexión por cable	70
Modo Bluetooth (HID)	70
<b>2.2 Carga</b>	70
<b>2.3 Modo de inventario</b>	71
<b>3. Indicadores LED</b>	72
<b>4. Especificaciones del producto</b>	72
<b>5. Lista de contenido</b>	72

No dude en comunicarse con nosotros si tiene algún problema para configurar el escáner de código de barras, como agregar/eliminar un prefijo o sufijo. Estamos siempre a tu servicio

## 1. Inicio Rápido

### 1.1 Cómo configurar

Cuando la base se conecta al ordenador mediante un cable USB, el indicador LED de la base se enciende, lo que indica que la base se ha conectado correctamente al ordenador y puede utilizarse como adaptador inalámbrico. Cuando el escáner se coloca en la base, el indicador LED de la base se volverá de color rojo, indicando que el escáner está conectado a la base correctamente y que también se puede cargar de esa forma.

Pulse el botón de escaneo y el lector de código de barras se encenderá y conectará la base automáticamente.

### 1.2 Ilustración de los botones

#### Botón del lector

ENCENDIDO: Pulse el botón de lectura para encender el escáner.

APAGADO: Mantenga el botón de lectura durante 2,5 s y el escáner se apagará.

#### Botones de la base

Interruptor de modo de lectura (☺) : Cuando el lector esté emparejado con la base, colóquelo en la base y pulse el botón para cambiar entre el modo de detección automática y el modo de apagado automático de la luz roja.

Cambio de modo de conexión (☺) :Pulsa el botón durante 3 segundos para cambiar entre el modo inalámbrico 2.4G y el modo Bluetooth.

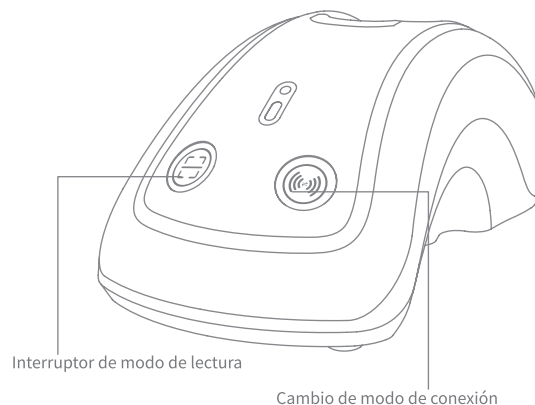

Interruptor de modo de lectura

Cambio de modo de conexión



Entrar a la configuración



Entrar a la configuración

### 1.3 Configuración

**Nota:**

- 1) Pasos de configuración de funciones: "Ingresar a la configuración"- "Código de barras de comando (p. ej., volumen bajo)" — "Guardar y salir".
- 2) Los marcados con (\*) en el manual indican configuraciones por defecto.

#### Configuración del Sistema



(\*) Windows/Android



Mac OS/iOS



Teclado Francés



Teclado Español



Teclado italiano

#### Configuración del Teclado



(\*) Teclado US



Teclado Alemán



Teclado Canadiense



Teclado UK



Guardar y salir



Salir y no guardar



Guardar y salir



Salir y no guardar



Entrar a la configuración



Entrar a la configuración



Teclado Japonés



Teclado Sueco



Reset de Fábrica



Teclado Holandés



Teclado Danés



Modo de detección automática



(\*) Modo de escaneo manual



Teclado Noruego



(\*) Activar la suspensión automática

#### 1.4 Código de Barras de uso frecuente



Guardar y salir



Salir y no guardar

ES ES



Guardar y salir



Salir y no guardar



Entrar a la configuración



Desactivar la suspensión automática



Volumen bajo



Silencioso



(\*) Volumen medio



Volumen alto



(\*) Activar la alerta por vibración débil



Convertir todas las letras en mayúsculas



Desactivar la alerta por vibración



Activar la alerta de vibración fuerte



Guardar y salir



Salir y no guardar

ES ES



Guardar y salir



Salir y no guardar



Entrar a la configuración



Convertir todas las letras en minúsculas



(\*) Añadir Enter como sufijo



(\*) No convertir las letras en mayúsculas



Utilizar el tabulador como sufijo



Guardar y salir



Salir y no guardar



Entrar a la configuración

## 2. Uso del BCST-91

### 2.1 Conexión

#### (\*) Modo de base inalámbrica

El modo Base inalámbrica es el modo por defecto. Cuando la base esté conectada al ordenador mediante un cable USB, el indicador LED de la base se encenderá, indicando que la base se ha conectado correctamente al ordenador y puede utilizarse como adaptador inalámbrico.

**Nota:** Si recibe un error al transmitir datos en el modo de base inalámbrica, coloque el escáner en la base y mantenga pulsado el botón  de cambio de modo de conexión para entrar en el modo de base inalámbrica y emparejar de nuevo el escáner con la base. También puede escanear los códigos de barras de comando en secuencia para volver a conectar el escáner con la base: "Entrar en configuración"--"Modo base inalámbrica"--"Guardar y salir".



Wireless Base Mode

#### Modo de conexión por cable

Conecte el lector con su ordenador a través del cable USB y se dará prioridad al cable USB para transmitir los datos aunque el lector se haya conectado antes a través de Bluetooth o de la base inalámbrica.

#### Modo Bluetooth (HID)

El modo Bluetooth (HID) no es un modo predeterminado. Para entrar en este modo, por favor pulse prolongadamente el botón de cambio de modo de conexión para cambiar al modo Bluetooth (HID) o escanee los códigos de barras de comandos en secuencia: "Entrar en configuración"- "Emparejamiento Bluetooth (Modo HID)" -- "Guardar y salir".



Emparejamiento Bluetooth (Modo HID)

### 2.2 Carga

1. Conecte la base con un ordenador/cargador mediante el cable USB y, a continuación, podrá cargar el escáner colocándolo en la base.
2. Conecte el lector con un ordenador/cargador con el cable USB incluido directamente para cargar el lector.



Guardar y salir



Salir y no guardar

### 2.3 Modo inventario

Los usuarios pueden usar el modo de inventario para mantener los códigos de barras escaneados en el caché del escáner y cargarlos en una computadora en lotes. En el modo de inventario, los usuarios no están restringidos a la hora o la ubicación cuando cargan datos. Además, los datos históricos se pueden borrar en el caché. Más detalles sobre el modo de inventario se encuentran a continuación.

**Nota:** No es necesario escanear "Entrar en la configuración" o "Guardar y salir" cuando se escanean los 5 códigos de barras siguientes. Basta con escanear los códigos de barras para activar las funciones.



Modo inventario



(\*) Modo común



Borrar los datos de la cache (Sólo para le modo de inventario)



Carga de datos (Sólo para el modo inventario)



Cargue el número de códigos de barras escaneados (Sólo para el modo inventario)

## 3. Indicadores LED

Estado del indicador - en el lector	
El LED verde parpadea una vez	Los datos se leen y se cargan.
El LED azul parpadea una vez	Los datos se leen y se almacenan en el buffer.
LED azul fijo	En el modo de configuración
LED rojo intermitente	Batería baja
LED rojo fijo	Se encuentra cargándose (luz roja se apaga cuando está completamente cargada)

Estado del indicador - en la base	
LED verde	El lector está completamente cargado
LED rojo	El lector está en su sitio y se está cargando.
LED azul intermitente	Emparejamiento inalámbrico o transmisión de datos
LED amarillo	no está en su sitio.

## 4. Especificaciones del producto

Material	ABS, PC, TPU
Voltaje	DC 5V
Capacidad de la batería	2600 mAh
Códigos de barra compatibles	Code 128, EAN-13, EAN-8, UPC-A, UPC-E, Code 39, Code 93, Codabar, Interleaved 2 of 5, Standard 2 of 5, Industrial 2 of 5, Matrix 2 of 5, MSI, Code 11, ISBN, ISSN, GS1 128, GS1 DataBar, GS1 DataBar Expanded, GS1 DataBar Limited, QRCode, PDF-417, Aztec Code, Data Matrix"
Resolución	3 mil
Método de lectura	Auto/Manual
Contraste más bajo	20%
Ángulo de decodificación	Ángulo de giro 30°, ángulo de elevación 75°, ángulo de desviación 80°
Frecuencia de comunicación	2.402GHz~2.480GHz

## 5. Contenido del paquete

BCST-91 \*1  
Cable USB A a USB C \*1  
Manual de Instrucciones \*1



## FCC Note

This device complies with part 15 of the FCC Rules. Operation is subject to the following two conditions: (1) This device may not cause harmful interference, and (2) this device must accept any interference received, including interference that may cause undesired operation.

Note: This equipment has been tested and found to comply with the limits for a Class B digital device, pursuant to part 15 of the FCC Rules. These limits are designed to provide reasonable protection against harmful interference in a residential installation. This equipment generates, uses and can radiate radio frequency energy and, if not installed and used in accordance with the Users, may cause harmful interference to radio communications. However, there is no guarantee that interference will not occur in a particular installation. If this equipment does cause harmful interference to radio or television reception, which can be determined by turning the equipment off and on, the user is encouraged to try to correct the interference by one or more of the following measures:

- Reorient or relocate the receiving antenna.
- Increase the separation between the equipment and receiver.
- Connect the equipment into an outlet on a circuit different from that to which the receiver is connected.
- Consult the dealer or an experienced radio/TV technician for help.

Note: The Grantee is not responsible for any changes or modifications not expressly approved by the party responsible for compliance. such modifications could void the user's authority to operate the equipment.

The device has been evaluated to meet general RF exposure requirement.

This equipment complies with FCC's RF radiation exposure limits set forth for an uncontrolled environment. This device and its antenna(s) must not be co-located or conjunction with any other antenna or transmitter.

## EU/UK Declaration of Conformity

Inateck Co., Ltd. hereby declares that this device complies with the Directive 2014/53/EU and SI 2017 No. 1206.

A copy of the Declaration of Conformity can be accessed from <https://www.inateck.de/pages/euro-compliance>.



## Service Center

### Europe

F&M Technology GmbH

Tel: +49 341 5199 8410 (Working day 8 AM - 4 PM CET)

Fax: +49 341 5199 8413

Address: Fraunhoferstraße 7, 04178 Leipzig, Deutschland

### North America

Inateck Technology Inc.

Tel: +1 (909) 698 7018 (Working day 9 AM - 5 PM PST)

Address: 2078 Francis St., Unit 14-02, Ontario, CA 91761, USA

### 日本

Inateck 株式会社

電話番号: +81 06 7500 3304

〒 547-0014 大阪府大阪市平野区長吉川辺 3 丁目 10 番 11 号

## Manufacturer

Shenzhen Inateck Technology Co., Ltd.

Address: Suite 2507, Block 11 in Tian An Cloud Park, Bantian Street, Longgang District, Shenzhen, Guangdong, China



F&M Technology GmbH  
Fraunhoferstraße 7, 04178 Leipzig, Deutschland  
Tel: +49 341 5199 8410



Inateck Technology (UK) Ltd.  
95 High Street, Office B, Great Missenden,  
United Kingdom, HP16 0AL  
Tel: +44 20 3239 9869

胶装

尺寸：160\*105mm

材质：参考之前说明书材质