

mimSAFE

www.mimsafe.se

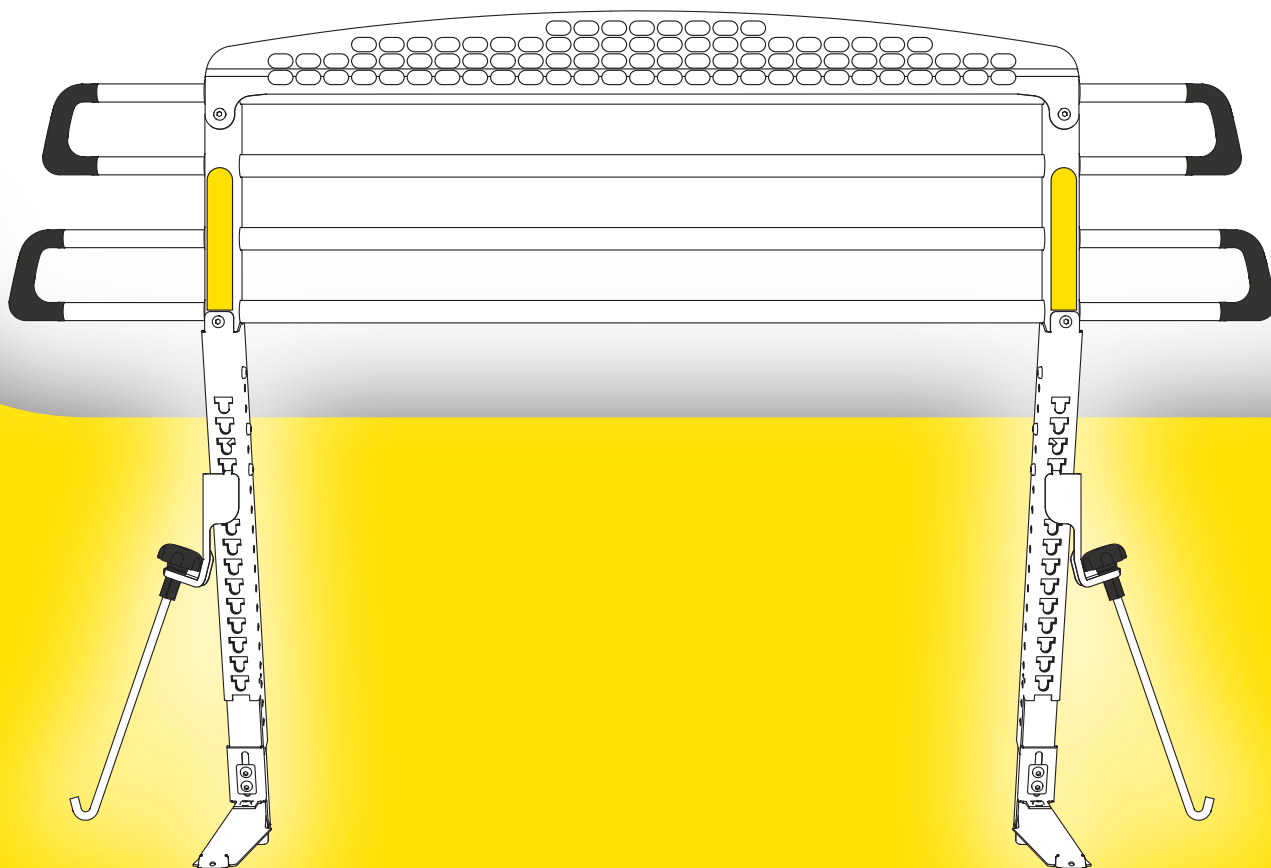

ASSEMBLY INSTRUCTIONS

VARIOBARRIER

small

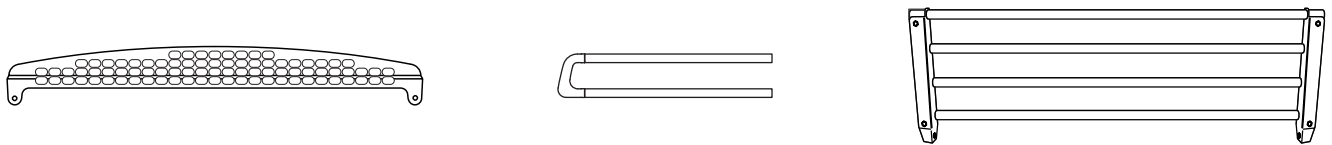
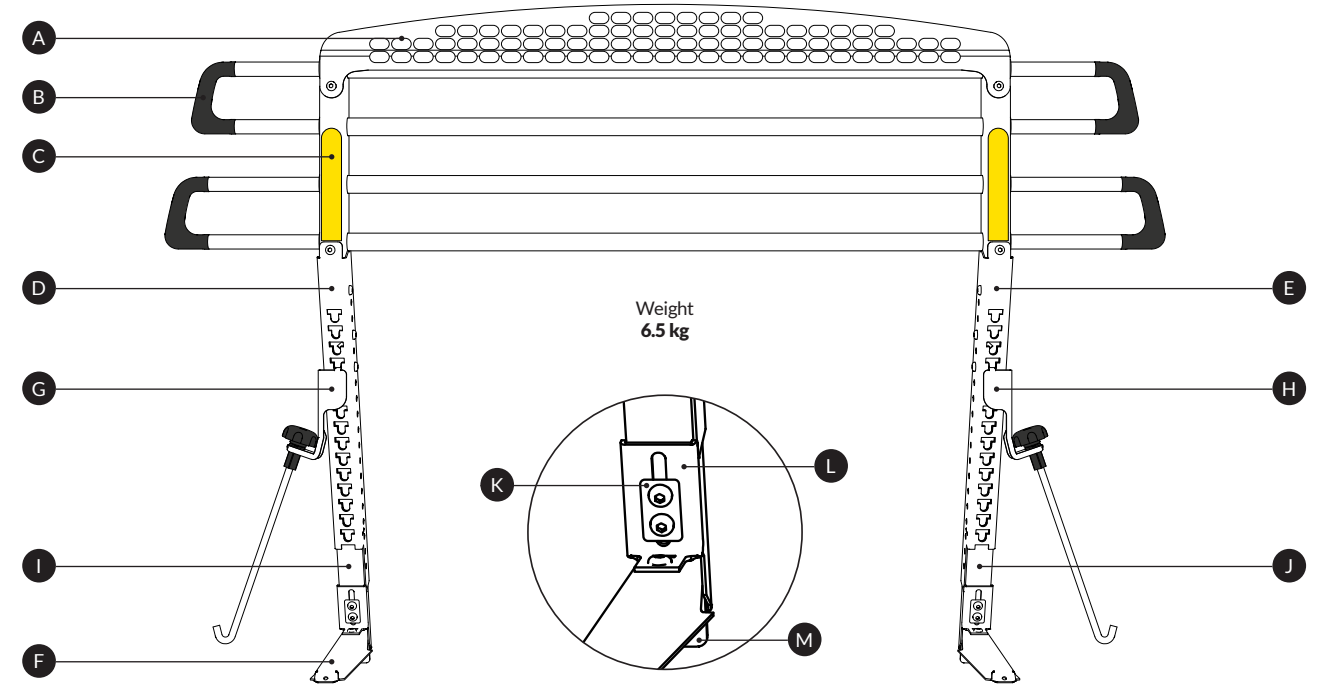

A F524
Part no 1x

B F521
Part no 4x

C FS508
Part no 1x

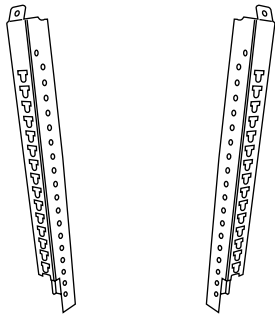

D F514L
Part no 1x

E F514R
Part no 1x



F F522
Part no 2x







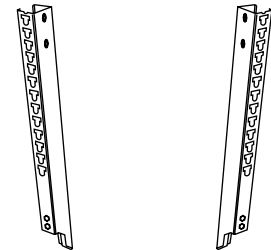





G F526L
Part no 1x

H F526R
Part no 1x

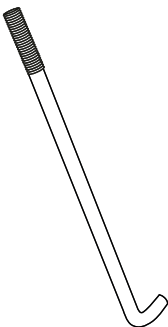

I F510L
Part no 1x

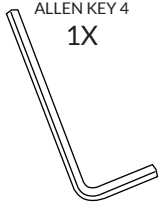
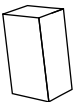
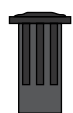
J F510R
Part no 1x

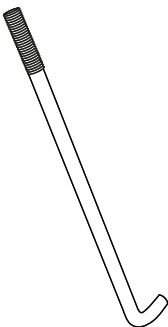
<p>M-10700 4X</p>  <p>OPTIONAL</p>	<p>F529 2X</p>  <p>K</p>	<p>F527 2X</p>  <p>L</p>	<p>F528 2X</p>  <p>M</p>	<p>M-460641AY 8X</p>  <p>rubber end caps</p>	<p>M-460641AL 8X</p>  <p>plastic end caps</p>	<p>F290A 2X</p> 
<p>M-SM6X14AI 18X</p> 	<p>ALLEN KEY 4 1X</p> 	<p>M-10683 2X</p> 	<p>M-460641K 2X</p> 	<p>M-460641I 2X</p> 		

STEP
1

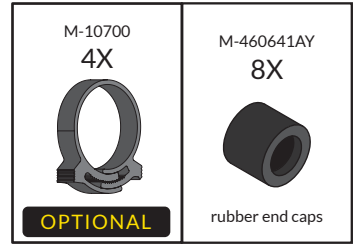
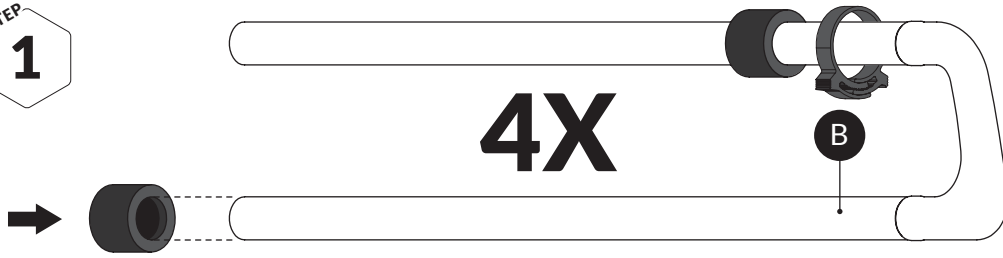

STEP
2

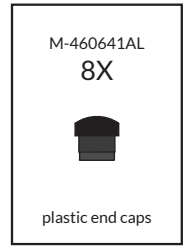
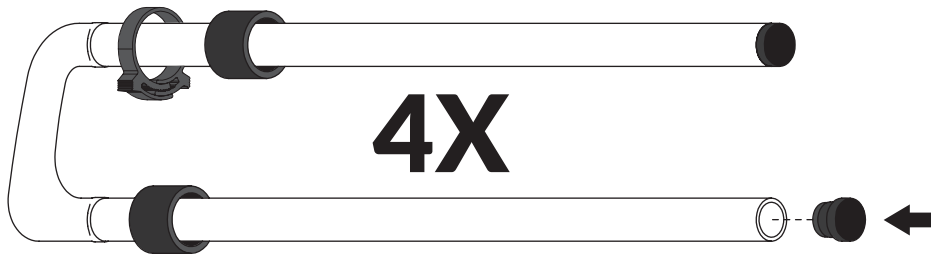

STEP
3

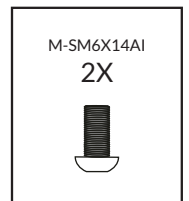
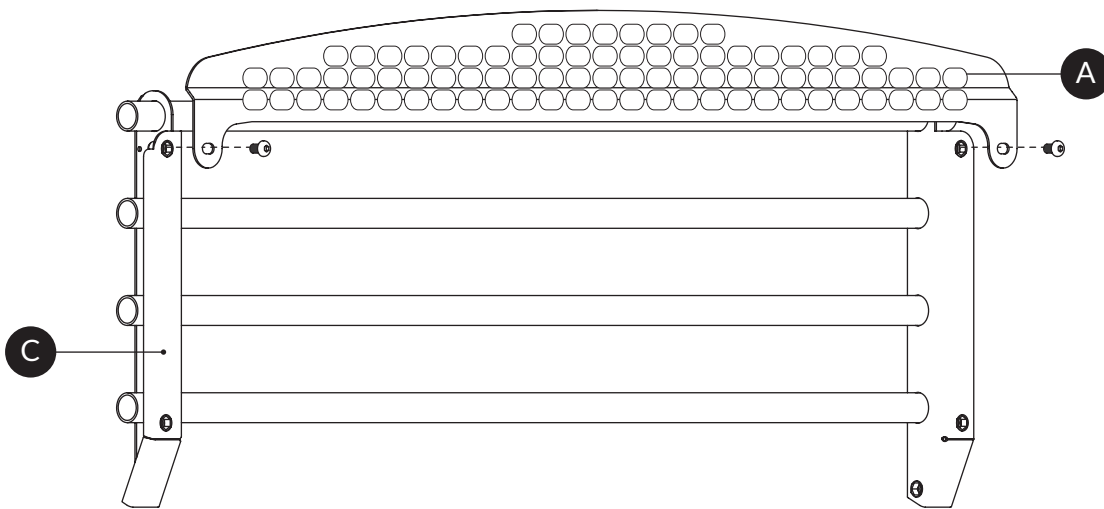

STEP
4

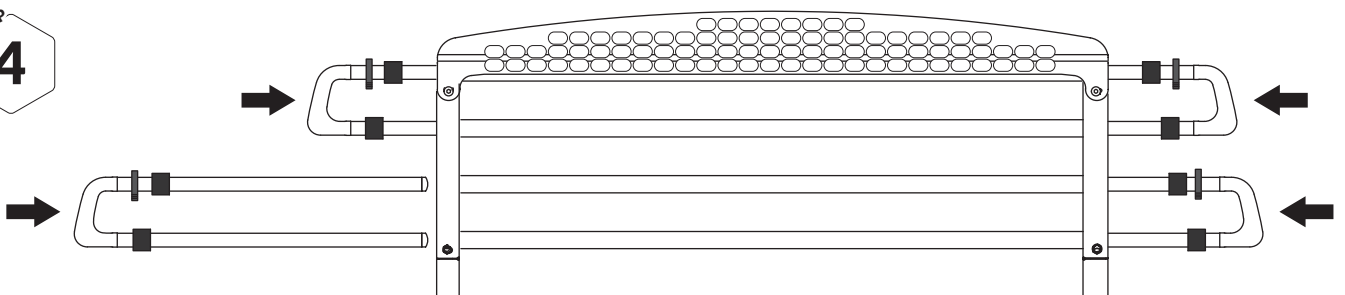

STEP
5

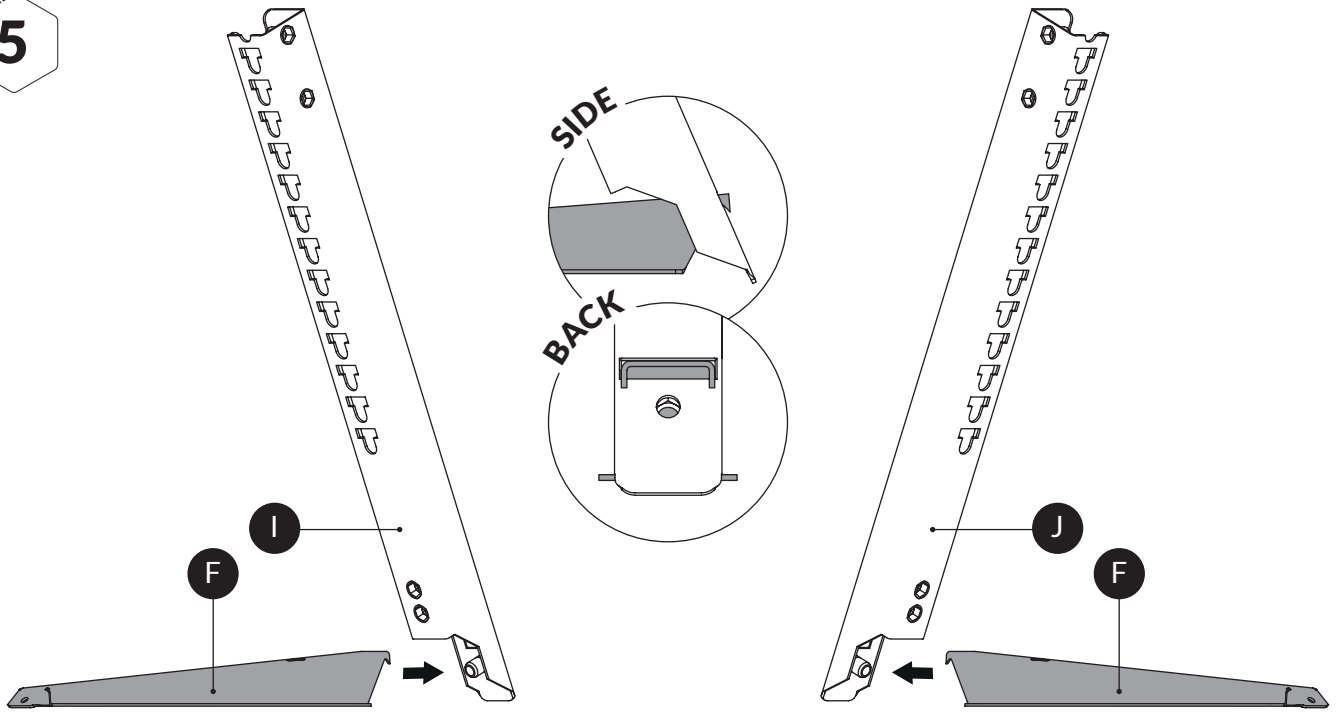

STEP
6

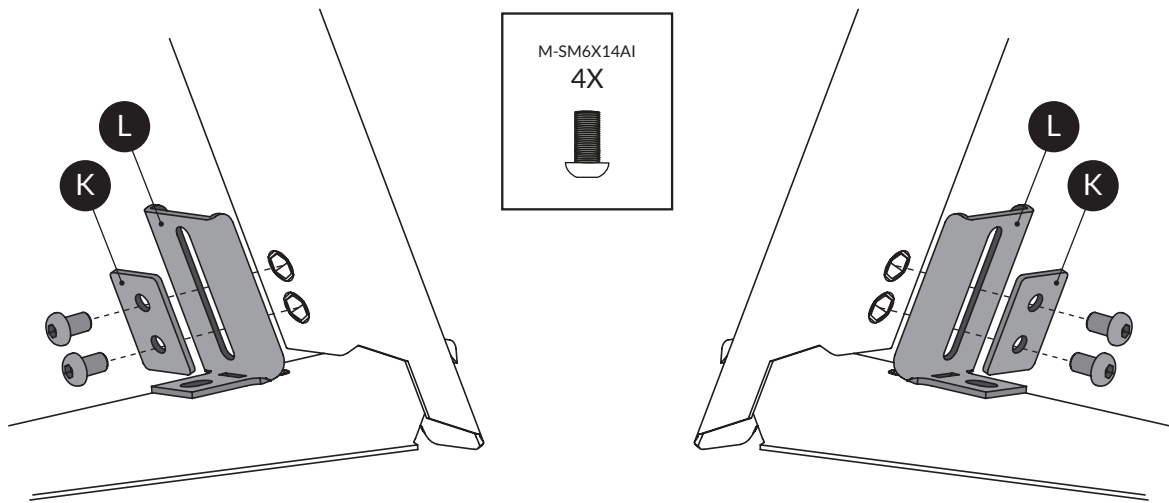

STEP
7

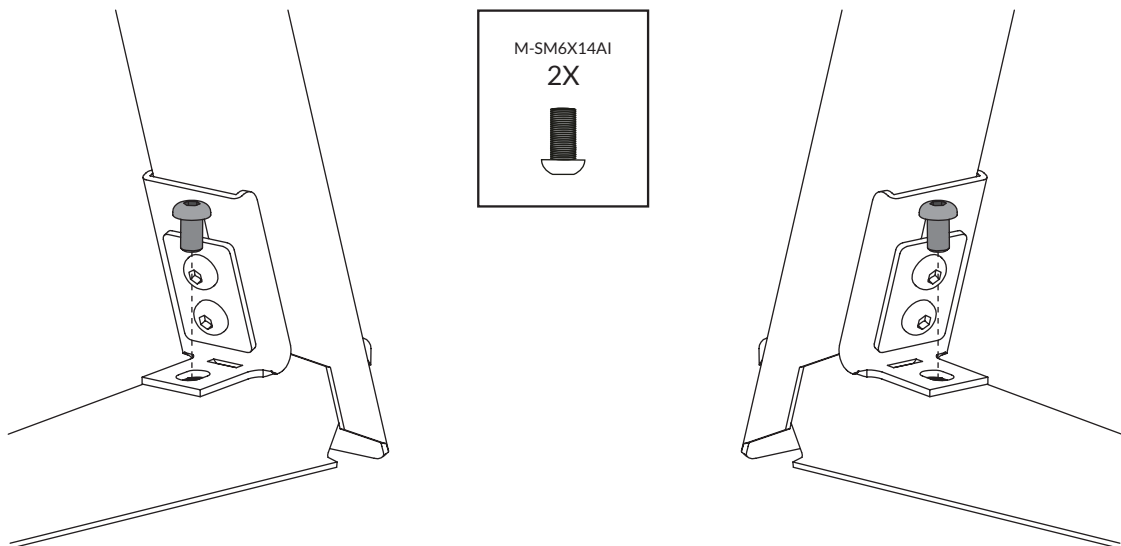

STEP
8

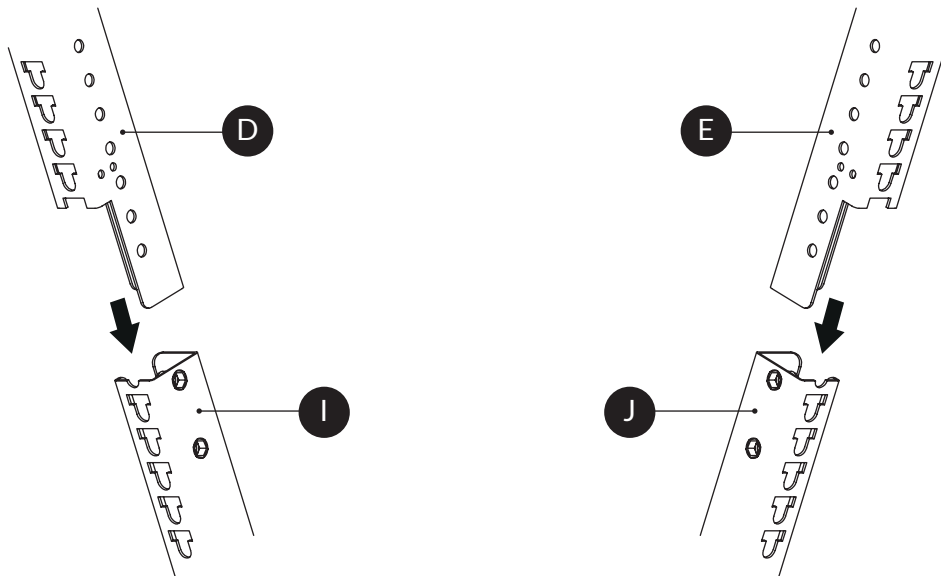

STEP
9

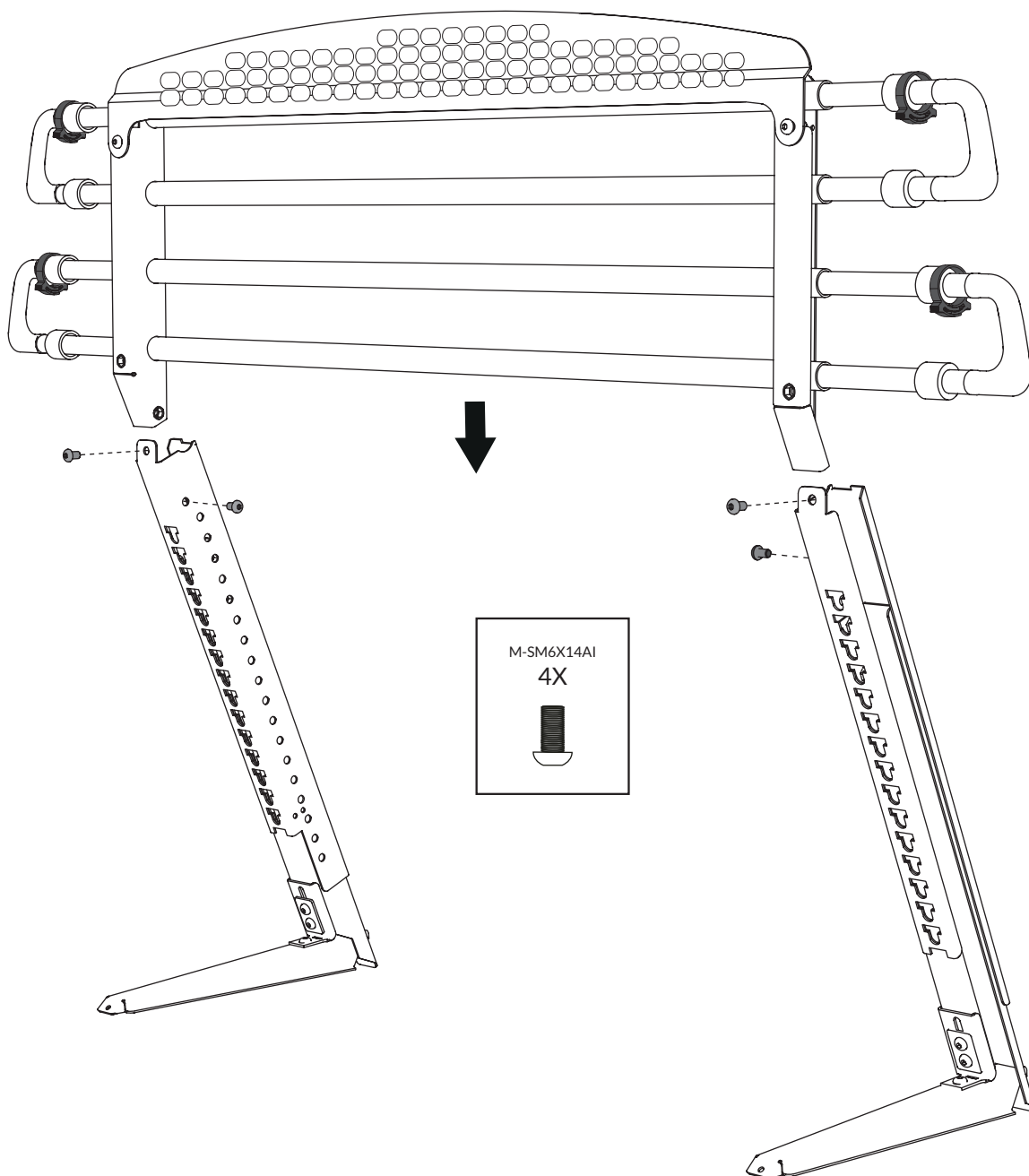

STEP
10

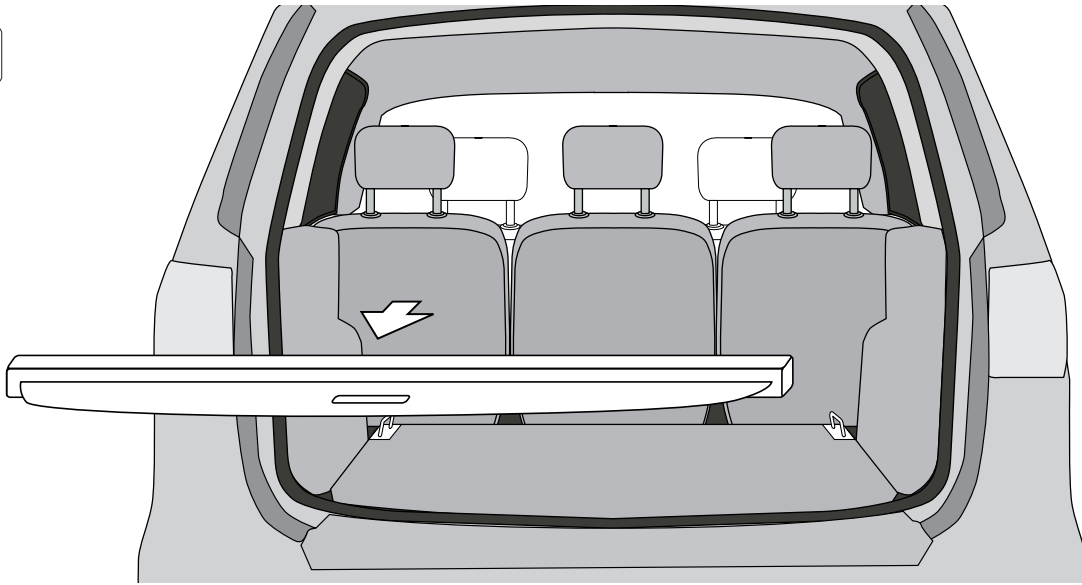

STEP
11

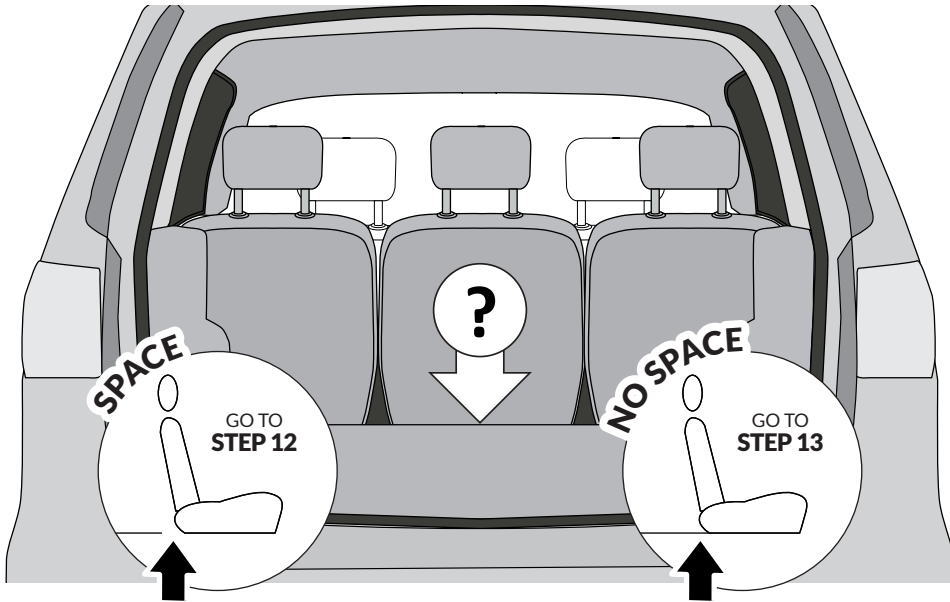

STEP
12

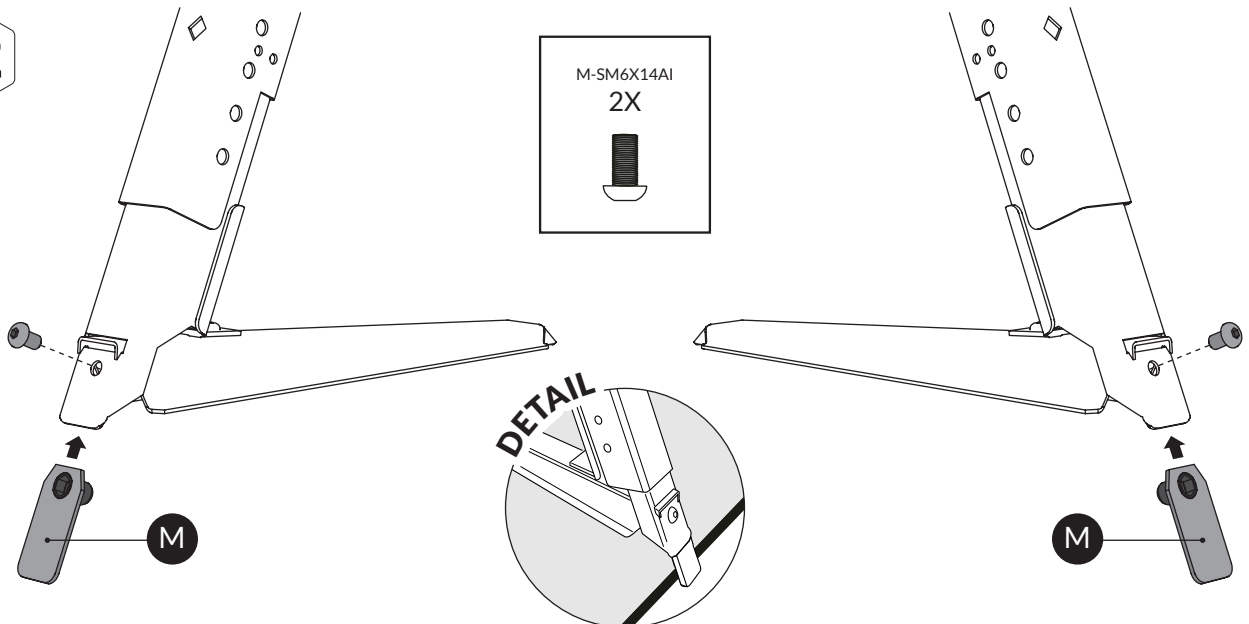

STEP
13

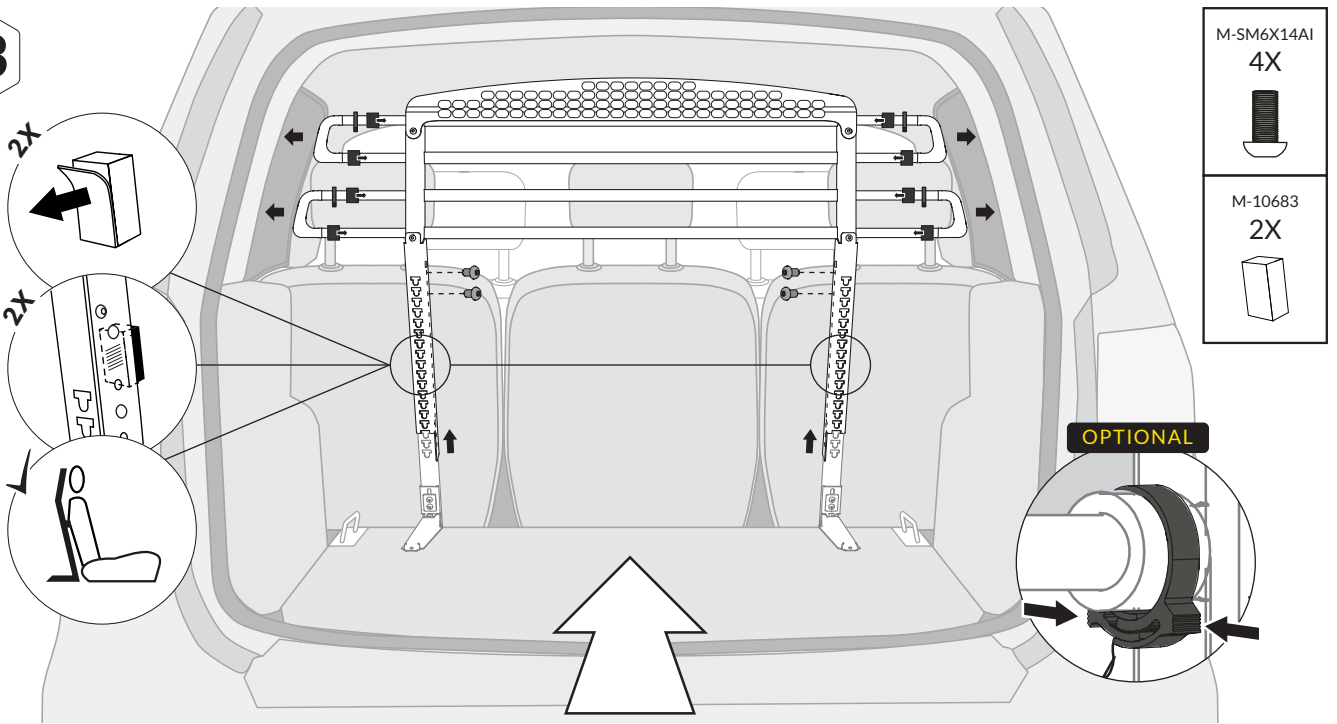

STEP
14

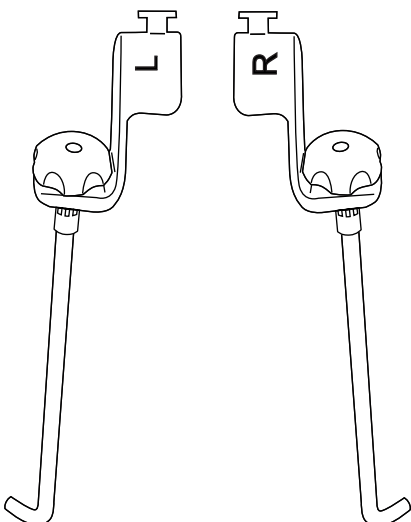
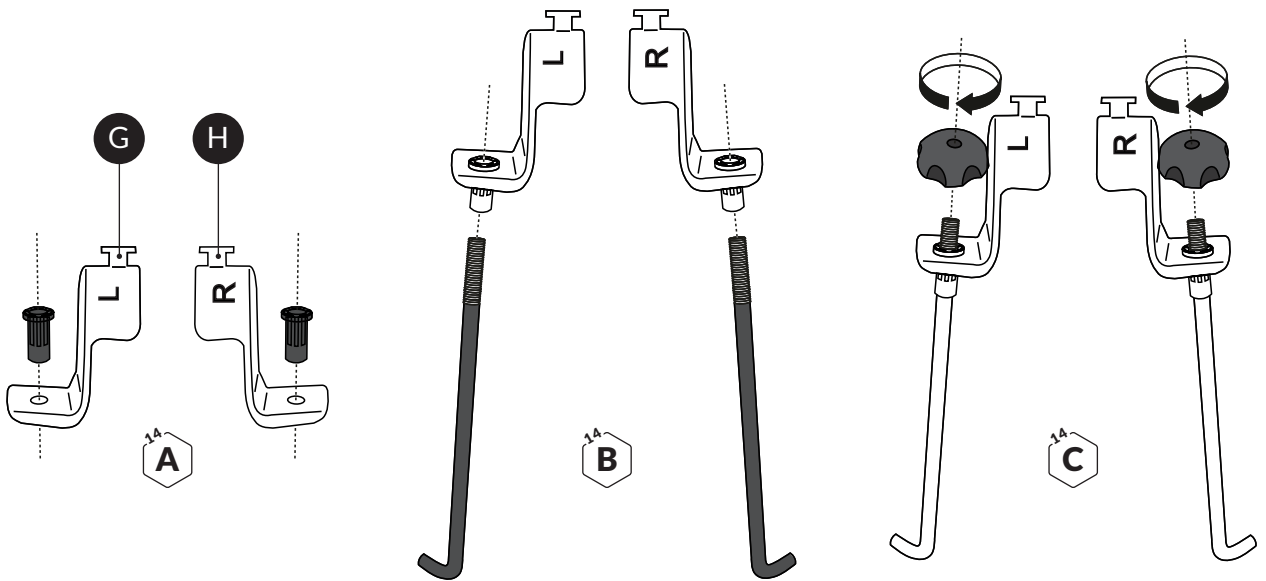

NO TOOLS IN THIS STEP
USE HANDS ONLY



M-460641K 2X	F290A 2X
M-460641I 2X	

STEP
15



STEP
16



USE HANDS ONLY
TIGHTEN THE WHEELS AGAIN
FEEL THE WHEEL SNAPPING

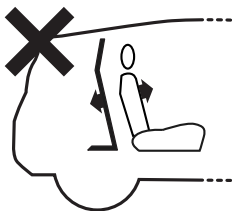
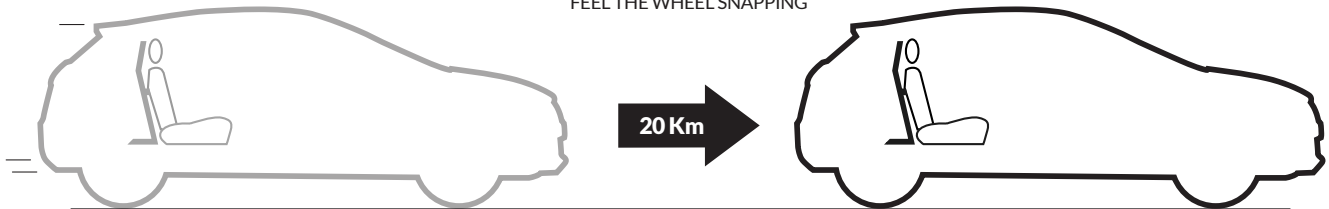

VarioBarrier must
ALWAYS BE PLACED
against the back seat



WARNING

VarioBarrier is
NOT SUITABLE FOR
outdoor use

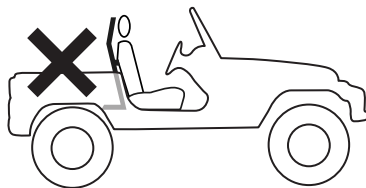

Wipe with a
DAMP CLOTH
with soap

