

Features

- 24" (610 mm) minimum base cabinet width.
- Single bowl.
- 9" (229 mm) depth provides generous workspace.

Material

- KOHLER® enameled cast iron.

Installation

- Undermount.

Recommended Products/Accessories

- K-8801 Sink drain and strainer with tailpiece
- K-8799 Sink drain and strainer basket
- K-23726 Drain treatment
- K-23725 Cast iron cleaner

Optional Products/Accessories

- K-11352 Disposal Flange with Stopper



ADA

Codes/Standards













ASME A112.19.1/CSA B45.2
ADA
ICC/ANSI A117.1

KOHLER® Enameled Cast Iron Kitchen Sink Lifetime Limited Warranty

See website for detailed warranty information.

Available Colors/Finishes

Color tiles intended for reference only.

Color	Code	Description
	0	White
	FF	Sea Salt™
	96	Biscuit
	FD	Cane Sugar™
	NY	Dune
	95	Ice™ Grey
	G9	Sandbar
	K4	Cashmere
	FT	Basalt
	58	Thunder™ Grey
	KA	Black 'n Tan
	FP	Caviar
	7	Black Black™

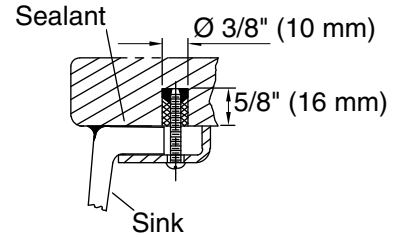
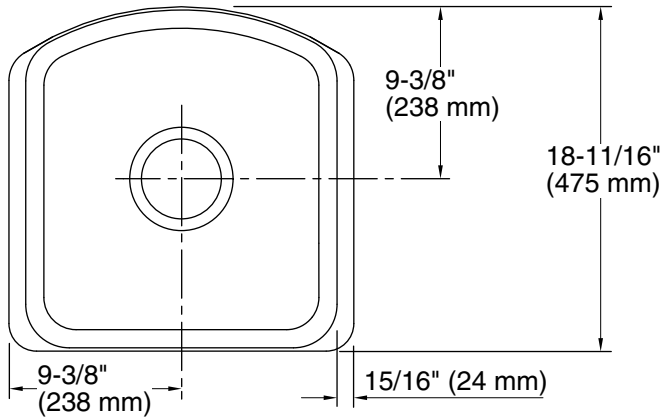

Solid-Surface
Installation

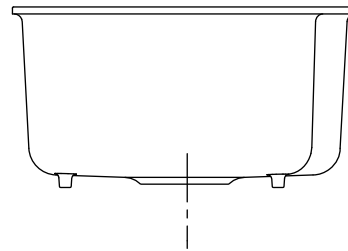
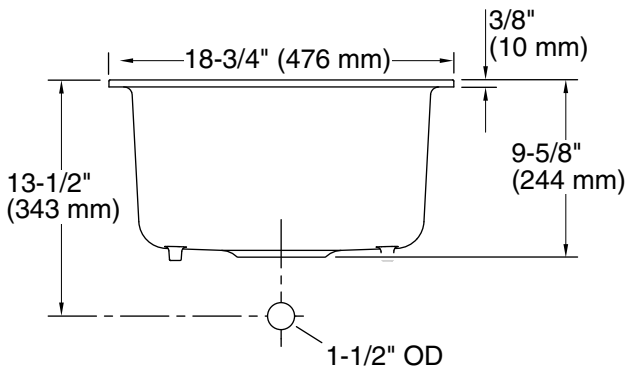

Technical Information

All product dimensions are nominal.

Installation:	Under-mount
Bowl area:	Length: 15-11/16" (399 mm) Width: 17-1/8" (435 mm) Bowl depth: 9" (229 mm) Water depth: 9" (229 mm)
Template:	1259678-7, required, included

Notes

Install this product according to the installation instructions.

ADA compliant when installed to the specific requirements of these regulations.

ADA permits a parallel approach to wet bars.