

Features

- Lever handle.
- Push-button diverter.
- High-temperature limit stop allows you to preset a comfortable maximum temperature to eliminate scalding.
- Completes Purist design solution with KOHLER fixtures and accessories.

Material

- Brass.

Required Products/Accessories

K-11748 Series Rite-Temp® Valves

Recommended Products/Accessories

K-23723 Faucet cleaner

Optional Products/Accessories

88526 Thin Wall Trim Kit



ADA **CSA B651** **OBC**

Codes/Standards

ASME A112.18.1/CSA B125.1

ADA

ICC/ANSI A117.1

CSA B651











OBC

KOHLER® Faucet Lifetime Limited Warranty

See website for detailed warranty information.

Available Colors/Finishes

Color tiles intended for reference only.

| Color | Code | Description |
|---|------|--------------------------------|
|  | CP | Polished Chrome |
|  | SN | Vibrant® Polished Nickel |
|  | AF | Vibrant® French Gold |
|  | PGD | Vibrant® Moderne Polished Gold |
|  | BGD | Vibrant® Moderne Brushed Gold |
|  | BN | Vibrant® Brushed Nickel |
|  | BV | Vibrant® Brushed Bronze |
|  | BL | Matte Black |
|  | 2MB | Vibrant® Brushed Moderne Brass |
|  | RGD | Vibrant Rose Gold |
| | VHR | |

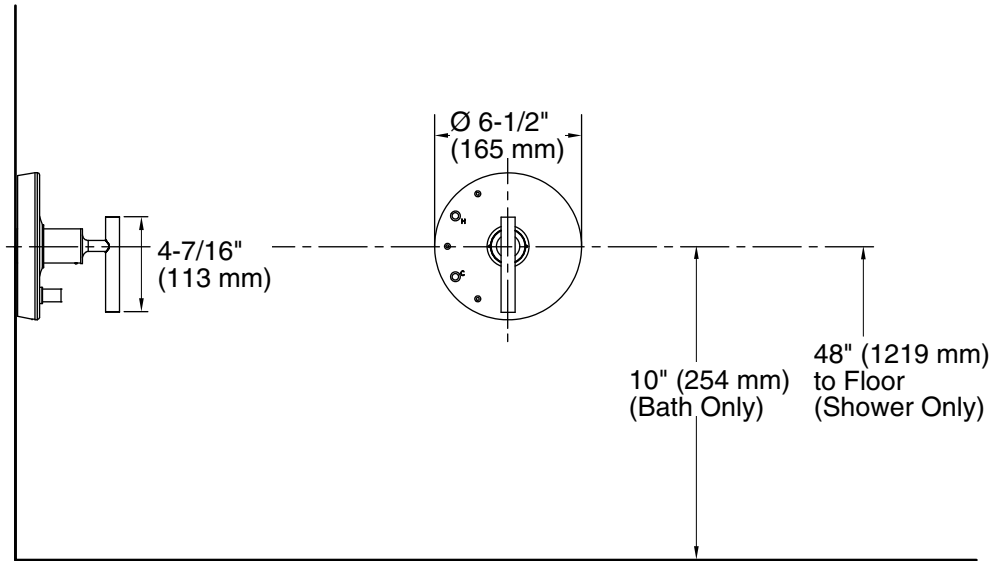

Technical Information

All product dimensions are nominal.

Drain included: No

Showerhead/Body Spray:

Rated maximum flow: 2.5 gal/min (9.5 l/min)

Notes

Install this product according to the installation guide.

Cap the shower outlet if deck-mount spout, diverter, or handshower is connected to the spout outlet.

ADA, OBC, CSA B651 compliant when installed to the specific requirements of these regulations.