

D-Code Toilet kit # D4005800

| < 15 1/2" Inch > |

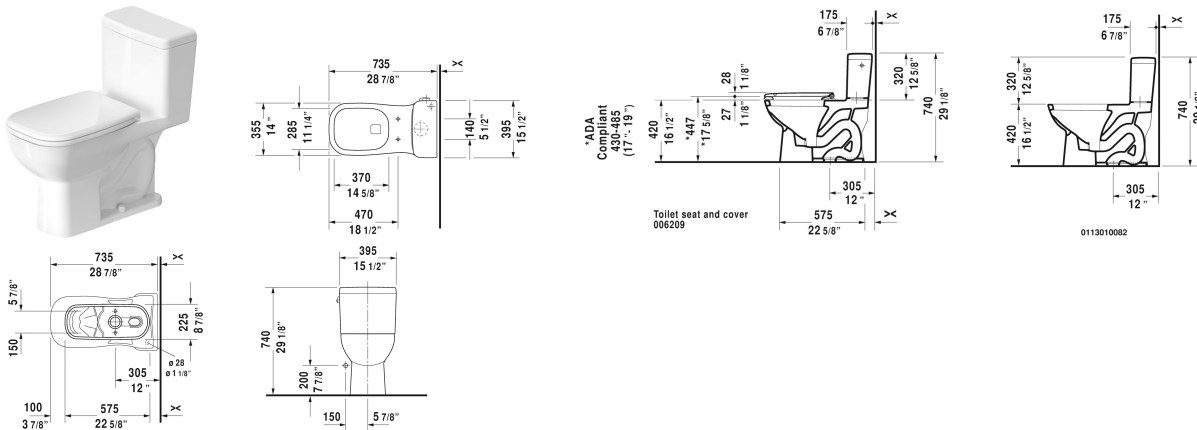

Toilet kit	Dimension	Weight	Order number
One-Piece toilet & Toilet seat and cover			
Colors			
00 White			
Variant			
	15 1/2" x 28 7/8" Inch	92.5 lb	D4005800
Suitable products			
One-Piece toilet syphonic, 12" rough-in, vertical outlet, cUPC® listed*, 1.28 gpf, 15 1/2" x 28 7/8" Inch	15 1/2" x 28 7/8" Inch		011301
Toilet seat and cover elongated, hinges stainless steel, removable, with slow close,			006209

All drawings contain the necessary measurements which are subject to standard tolerances. They are stated in inch & mm and are non-binding. Exact measurements, in particular for customized installation scenarios, can only be taken from the finished ceramic piece.