



# Iron Plains® Capsule

Drop-in/undermount bathroom sink  
**K-20213**

## Features

- Elongated oval basin.
- No faucet holes; requires wall- or counter-mount faucet.
- Overflow drain.

## Material

- KOHLER® enameled cast iron.

## Installation

- Drop-in or undermount.

## Recommended Products/Accessories

- K-23726 Drain treatment
- K-23725 Cast iron cleaner

## Included Components

- Additional Components:
- 1193643 Basin clamps



ADA

CSA B651

## Codes/Standards











ASME A112.19.1/CSA B45.2  
ADA  
ICC/ANSI A117.1  
CSA B651

## Lifetime Limited Warranty for KOHLER® Cast Iron Components

See website for detailed warranty information.

## Available Colors/Finishes

*Color tiles intended for reference only.*

Color	Code	Description
	0	White
	FF	Sea Salt™
	96	Biscuit
	NY	Dune
	FT	Basalt
	KA	Black 'n Tan
	7	Black Black™
	GRL	Grey Lavender
	DGB	Indigo Blue
	PLM	Black Plum

1-800-4KOHLE (1-800-456-4537)

Kohler Co. reserves the right to make revisions without notice to product specifications.

For the most current Specification Sheet, go to [www.kohler.com](http://www.kohler.com).

5-29-2021 16:38 - US/CA

THE BOLD LOOK  
OF **KOHLER**®



# Iron Plains® Capsule

Drop-in/undermount bathroom sink  
K-20213

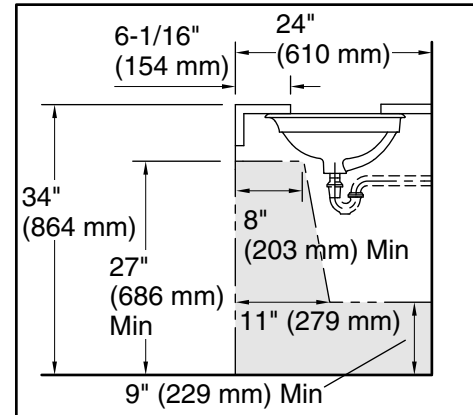
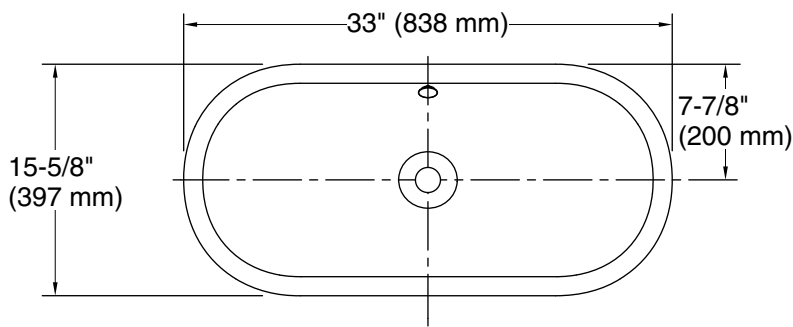

Recommended ADA Installation

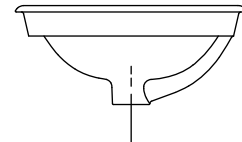
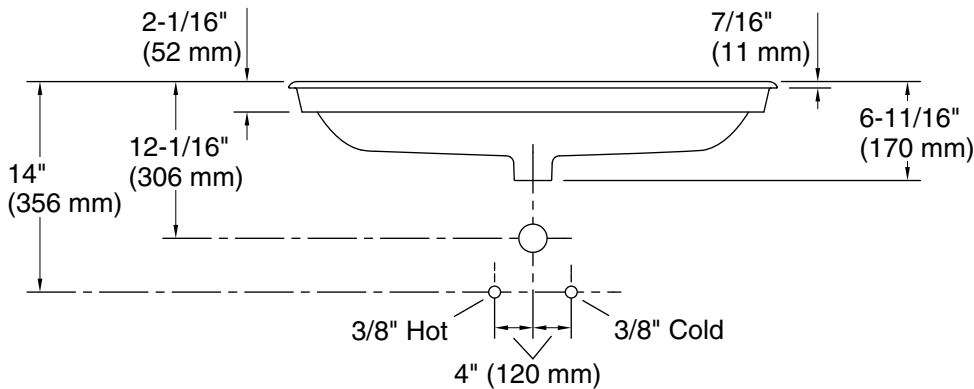

## Technical Information

All product dimensions are nominal.

Installation:	Drop-in, Under-mount
Bowl area (Only):	Length: 31-13/16" (808 mm) Width: 14-7/16" (367 mm) Bowl depth: 4-11/16" (120 mm) Water depth: 3-1/4" (83 mm)
Drain hole:	1-3/4" (44 mm)
Template:	1319049-7, required, included

## Notes

Install this product according to the installation instructions.

Countertop manufacturer or cutter must use the cut-out template provided with the product, or a current one provided by Kohler Co. (call 1-800-43-FOCUS). Kohler Co. is not responsible for cut-out errors when the incorrect cut-out template is used.

ADA, CSA B651 compliant when installed to the specific requirements of these regulations.