

Features

- 5-3/4" (146 mm) diverter bath spout with 1/2" NPT connection.
- NPT connection.
- Coordinates with the Bancroft collection of faucets and accessories.

Material

- Premium metal construction for durability and reliability.
- KOHLER finishes resist corrosion and tarnishing.

Installation

- Bath- or deck-mount.
- Wall-mount.

Recommended Products/Accessories

K-23723 Faucet cleaner



Codes/Standards







ASME A112.18.1/CSA B125.1

KOHLER® Faucet Lifetime Limited Warranty

See website for detailed warranty information.

Available Colors/Finishes

Color tiles intended for reference only.

| Color | Code | Description |
|---|------|--------------------------|
|  | CP | Polished Chrome |
|  | SN | Vibrant® Polished Nickel |
|  | BN | Vibrant® Brushed Nickel |
|  | BV | Vibrant® Brushed Bronze |
|  | BRZ | Oil-Rubbed Bronze |
|  | 2BZ | Oil-Rubbed Bronze |

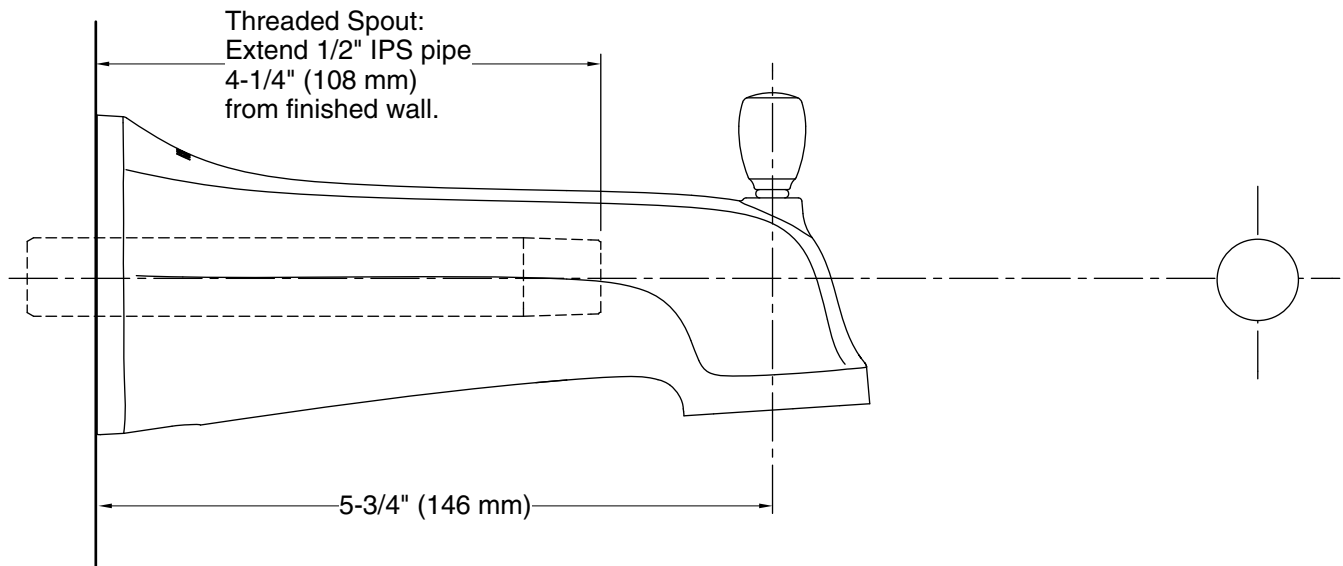

Technical Information

All product dimensions are nominal.

Drain included: No

Notes

Install this product according to the installation guide.

Install straight pipe or tube drop of 7" (178 mm) to 18" (457 mm) with single elbow between valve and wall-mount spout.