

**PRODUCT SPECIFICATIONS**

Dayton Stainless Steel 25-7/16" x 13-3/8" x 1" Bottom Grid. Overall dimensions are 25-7/16" x 13-3/8" x 1".

Made of Stainless Steel

Bottom grids are:

- Custom designed to protect and cover the bottom of your sink.
- Properly positioned opening for convenient access to drain or disposer.
- Built from solid stainless steel to resist corrosion and provide years of service.

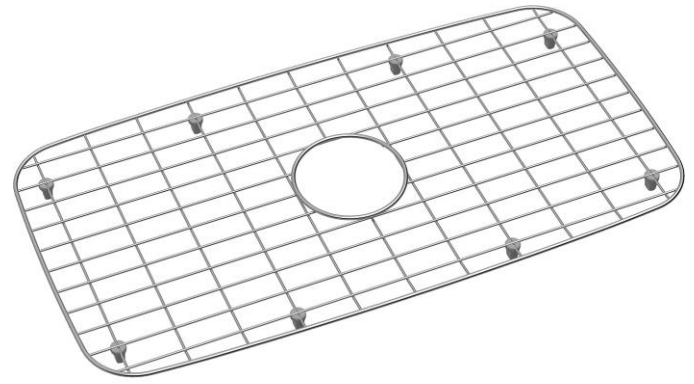

<b>Material:</b>	Stainless Steel
<b>Finish:</b>	Polished Stainless Steel
<b>Dimensions:</b>	25-7/16" x 13-3/8" x 1"
<b>Fits Bowl Size(s):</b>	28" x 15-3/4"

AMERICAN PRIDE. A LIFETIME TRADITION. Like your family, the Elkay family has values and traditions that endure. For almost a century, Elkay has been a family-owned and operated company, providing thousands of jobs that support our families and communities.

[Clean and Care Manual \(PDF\)](#)

[Clean and Care Manual \(PDF\)](#)

[Installation Instructions \(PDF\)](#)

[Warranty \(PDF\)](#)

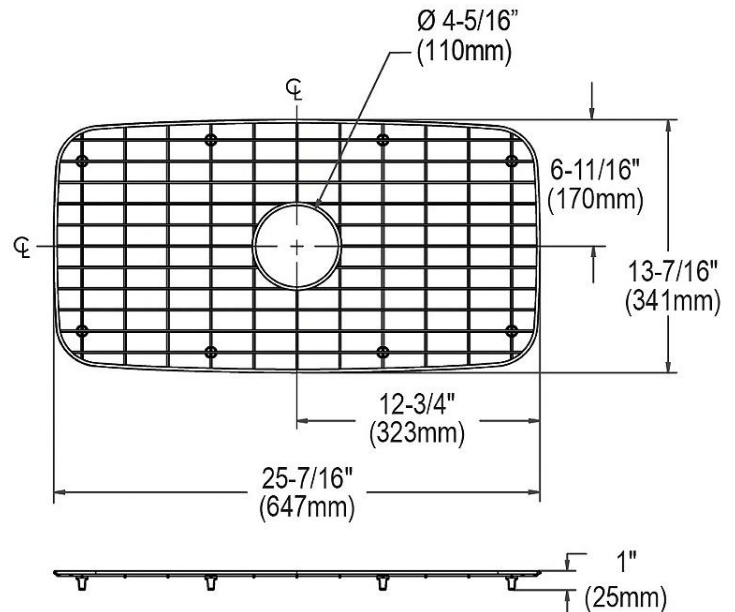

PART: \_\_\_\_\_ QTY: \_\_\_\_\_

PROJECT: \_\_\_\_\_

CONTACT: \_\_\_\_\_

DATE: \_\_\_\_\_

NOTES: \_\_\_\_\_

APPROVAL: \_\_\_\_\_

*In keeping with our policy of continuing product improvement, Elkay reserves the right to change product specifications without notice. Please visit [elkay.com](http://elkay.com) for the most current version of Elkay product specification sheets. This specification describes an Elkay product with design, quality, and functional benefits to the user. When making a comparison of other producers' offerings, be certain these features are not overlooked.*