

PRODUCT SPECIFICATIONS

Elkay Quartz Classic® 15-3/4" x 15-3/4" x 7-11/16", Single Bowl Dual Mount Bar Sink. Sink is molded with up to 80% natural quartz and high performance acrylic resins that are non-porous providing superior heat, scratch, fade and stain resistance. Naturally sound deadening and Rear Center drain placement.



Installation Type:	Drop-in, Undermount
Material:	Quartz
Finish:	Bisque (BQ), Black (BK), Dusk Gray (GY), Greige (GR), Greystone (GS), Mocha (MC), Putty (PT), White (WH)
Number of Bowls:	1
Sink Dimensions:	15-3/4" x 15-3/4" x 7-11/16"
Bowl 1 Dimensions:	13-1/8" x 13-1/8" x 7-11/16"
Drain Size:	3-1/2" (89mm)
Drain Location:	Rear Center
Minimum Cabinet Size:	21"
Mounting Hardware:	Part # 64090404 included for drop-in installation for countertops up to 1-3/4" (44mm) thick. Part # 54300404 included for undermount installation.
Template Included:	Yes
Cutout Template #:	1000003495_undermount 1000003497_topmount

Template is available for download at elkay.com. CAD software will be required to open the template.

Cutout Dimensions for Drop-in Installation:

15-1/8" x 15-1/8" (384mm x 384mm) with 3/8" (10mm) corner radius



AMERICAN PRIDE. A LIFETIME TRADITION.

Like your family, the Elkay family has values and traditions that endure. For almost a century, Elkay has been a family-owned and operated company, providing thousands of jobs that support our families and communities.

Product Compliance: CSA B45.5/IAPMO Z124



Sinks are listed by IAPMO® as meeting the applicable requirements of the Uniform Plumbing Code®, International Plumbing Code®, and National Plumbing Code of Canada.

- [Clean and Care Manual \(PDF\)](#)
- [Installation Instructions \(PDF\)](#)
- [Warranty \(PDF\)](#)

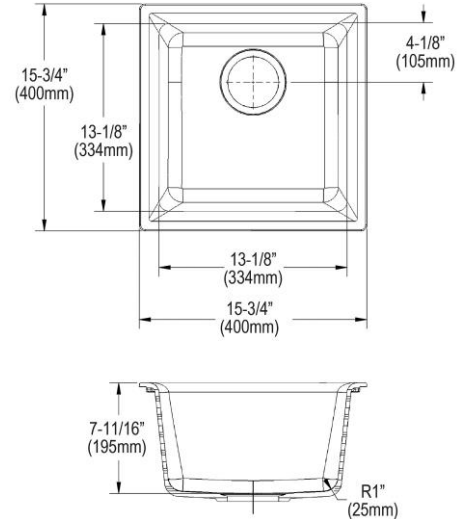

PART: _____ QTY: _____
 PROJECT: _____
 CONTACT: _____
 DATE: _____
 NOTES: _____
 APPROVAL: _____

In keeping with our policy of continuing product improvement, Elkay reserves the right to change product specifications without notice. Please visit elkay.com for the most current version of Elkay product specification sheets. This specification describes an Elkay product with design, quality, and functional benefits to the user. When making a comparison of other producers' offerings, be certain these features are not overlooked.

Installation Profile:

DROP-IN

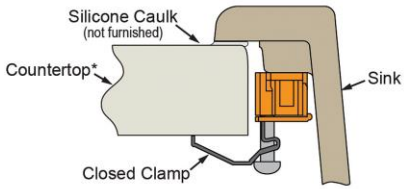



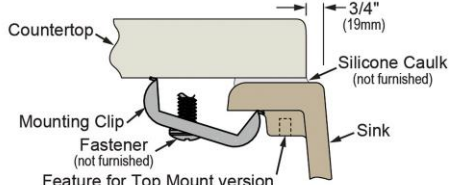

*Maximum thickness for use of hold down system is 1-3/4" (44mm).

UNDERMOUNT - 3/4" REVEAL



Feature for Top Mount version (not used in Undermount model)
Designed to affix to the underside of any solid surface countertop.

Optional Accessories		
LKOBG1616SS	Elkay Stainless Steel 11-1/2" x 11-1/2" x 1" Bottom Grid	
LK99	Elkay Deluxe 3-1/2" Drain Type 304 Stainless Steel Body, Strainer Basket Rubber Seal and Tailpiece	
LKQD35	Elkay Polymer 3-1/2" Disposer Flange with Removable Basket Strainer and Rubber Stopper	
LKQS35	Elkay Polymer 3-1/2" Drain Fitting with Removable Basket Strainer and Rubber Stopper	
LKWRB1209SS	Elkay Stainless Steel 8" x 11" x 7" Rinsing Basket	

In keeping with our policy of continuing product improvement, Elkay reserves the right to change product specifications without notice. Please visit elkay.com for the most current version of Elkay product specification sheets. This specification describes an Elkay product with design, quality, and functional benefits to the user. When making a comparison of other producers' offerings, be certain these features are not overlooked.