

PRODUCT SPECIFICATIONS

Dayton Stainless Steel 25" x 19" x 6-5/16", Equal Double Bowl Drop-in Sink. Sink is manufactured from 22 gauge 300 series Stainless Steel with a Satin finish, Center drain placement, and Bottom only pads.

Installation Type:	Drop-in
Material:	300 series Stainless Steel
Finish:	Satin
Gauge:	22
Sound Deadening:	Bottom only pads
Number of Bowls:	2
Sink Dimensions:	25" x 19" x 6-5/16"
Bowl 1 Dimensions:	10" x 14" x 6-1/8"
Bowl 2 Dimensions:	10" x 14" x 6-1/8"
Drain Size:	3-1/2" (89mm)
Drain Location:	Center
Minimum Cabinet Size:	30"
Mounting Hardware:	Part # 64090012 included for countertops up to 3/4" (19mm) thick
Template Included:	No
Cutout Template #:	1000001247

Template is available for download at [elkay.com](#). CAD software will be required to open the template.

Cutout Dimensions for Drop-in Installation:

24-3/8" x 18-3/8" (619mm x 467mm) with 1-1/2" (38mm) corner radius



AMERICAN PRIDE. A LIFETIME TRADITION.

Like your family, the Elkay family has values and traditions that endure. For almost a century, Elkay has been a family-owned and operated company, providing thousands of jobs that support our families and communities.



Product Compliance: ADA & ICC A117.1
ASME A112.19.3/CSA B45.4
Buy American Act



Sinks are listed by IAPMO[®] as meeting the applicable requirements of the Uniform Plumbing Code[®], International Plumbing Code[®], and National Plumbing Code of Canada.



Complies with ADA & ICC A117.1 accessibility requirements when installed according to the requirements outlined in these standards.

[Clean and Care Manual \(PDF\)](#)
[Installation Instructions \(PDF\)](#)
[Warranty \(PDF\)](#)

Hole Drilling Configurations:

1-1/2" (38mm) Diameter Faucet Holes on 4" (102mm) Centers

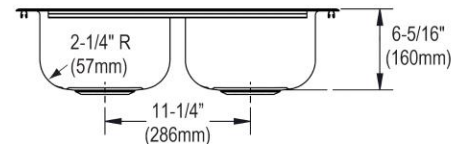
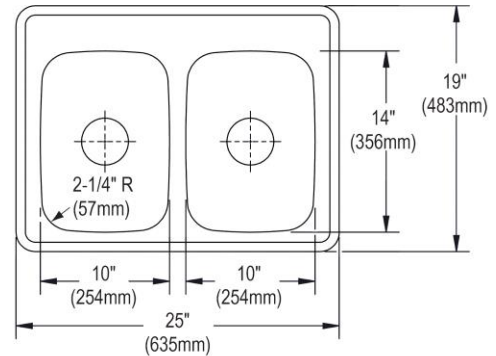
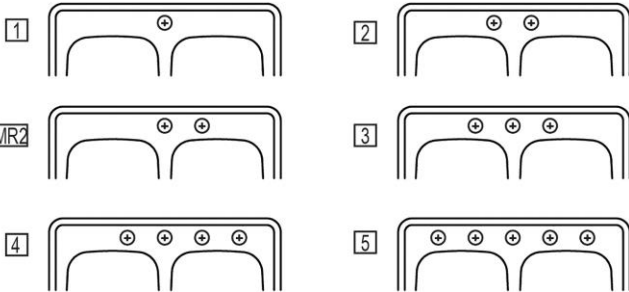

PART: _____ QTY: _____

PROJECT: _____

CONTACT: _____

DATE: _____



NOTES: _____

APPROVAL: _____

In keeping with our policy of continuing product improvement, Elkay reserves the right to change product specifications without notice. Please visit [elkay.com](#) for the most current version of Elkay product specification sheets. This specification describes an Elkay product with design, quality, and functional benefits to the user. When making a comparison of other producers' offerings, be certain these features are not overlooked.

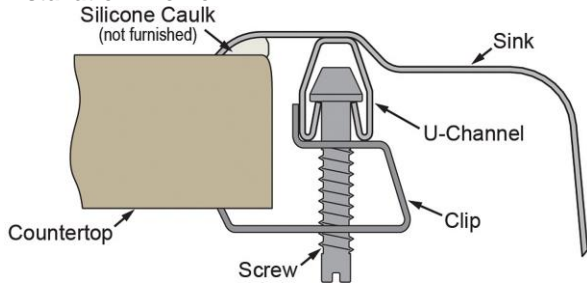
Installation Profile:



Optional Accessories		
CB912	Elkay Hardwood 12-7/8" x 10-1/8" x 1" Cutting Board	
D1125	Dayton 3-1/2" Stainless Steel Drain with Removable Basket Strainer and Rubber Stopper	
LKWRB1209SS	Elkay Stainless Steel 8" x 11" x 7" Rinsing Basket	

In keeping with our policy of continuing product improvement, Elkay reserves the right to change product specifications without notice. Please visit elkay.com for the most current version of Elkay product specification sheets. This specification describes an Elkay product with design, quality, and functional benefits to the user. When making a comparison of other producers' offerings, be certain these features are not overlooked.