

Installation Support • Soporte de instalación • Support d'installation

Personal Assistance, Product Specs, & "How-to" Questions:

Asistencia personal, especificaciones del producto y preguntas sobre "cómo hacerlo":

Aide personnelle, spécifications du produit et questions « pratique-pratiques » :

1-800-PFAUCET (732-8238)

pfisterfaucets.com/support

Installation Videos Available
Videos de instalación a disposición
Vidéos d'installation disponibles



pfisterfaucets.com/videos

▲ WARNING / AVERTENCIA / AVERTISSEMENT

To reduce the risk of injury or property damage, read all instructions before installing product. Wear safety goggles. Product must be installed in accordance with all state & local plumbing & building codes. Call a professional if you are uncertain about installing this product.

Para disminuir el riesgo de lesiones o daños a la propiedad, lea todas las instrucciones antes de instalar el producto. Utilice gafas de seguridad. El producto deberá instalarse de acuerdo con la normativa de plomería y construcción estatal y local. Llame a un profesional si no está seguro sobre cómo instalar este producto.

Pour réduire le risque de blessures ou de dommages, lisez toutes les instructions avant d'installer l'appareil. Porter des lunettes de sécurité. Il faut installer l'appareil en respectant tous les codes de construction et de plomberie locaux et d'État. Appelez un professionnel si vous n'êtes pas certain de la façon d'installer cet appareil.

Required Tools
Herramientas necesarias
Outils nécessaires

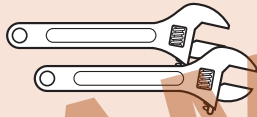

Adjustable Wrenches
Llaves ajustables
Clés à mollette



Safety Goggles
Anteojos de seguridad
Lunettes de sûreté

Additional Helpful Tools
Otras herramientas útiles
Outils supplémentaires utiles

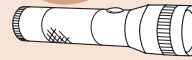

Flashlight
Linterna
Lampe-torche



Cloth
Paño de limpieza
Chiffon

Parts in the Box • Piezas en la caja • Pièces dans la boîte

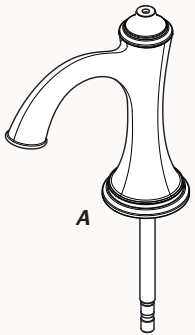

A



B (x2)



C



D

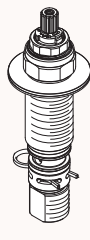

E (x2)



F (x2)



G (x2)

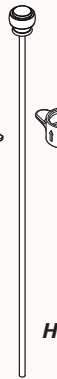

H

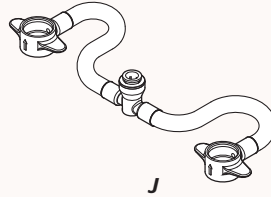

J

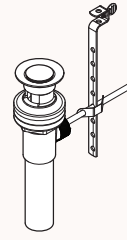

K

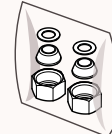

L



Aerator Tool
Herramienta aireador
Outil d'aérateur

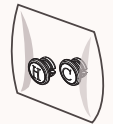

Optional Ceramic Cap
(refer to included Flyer)
Cubierta de Cerámica opcional
(refiere al folleto incluido)
Couverture Céramique option
(voir petit livret inclus)

1 Turn Off Water Supply • Cierre el suministro de agua • Couper l'alimentation en eau



Locate water supply inlets and shut off the water supply valves. These are usually found under the sink or near the water meter. If you are replacing an existing faucet, remove the old faucet from the sink and clean the sink surface thoroughly.

Ubique las entradas del suministro de agua y cierre las válvulas de suministro de agua. Generalmente se encuentran debajo del fregadero o cerca del medidor de agua. Si se trata de un reemplazo de grifo, quite el grifo viejo y limpie completamente la superficie del fregadero.

Repérer les arrivées d'eau et fermer leurs robinets. Ces robinets se trouvent généralement sous le lavabo ou à côté du compteur d'eau. En cas de remplacement d'un robinet existant, le déposer du lavabo et nettoyer soigneusement la surface de ce dernier.

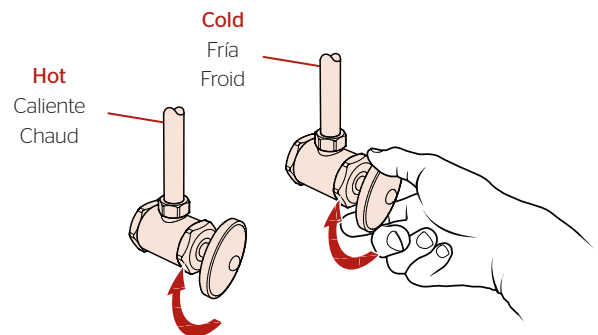

2

Prepare & Install Valve Bodies

Prepare e instale los cuerpos de la válvula

Préparez et installez les vannes



Adjustable Wrench
Llave ajustable
Clé réglable

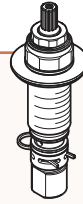

E (x2)



F (x2)



G (x2)

2A

Disassemble Valves

Desensamble las válvulas

Démontez les vannes

x2

Hot & Cold
Caliente y fría
Chaud et froid

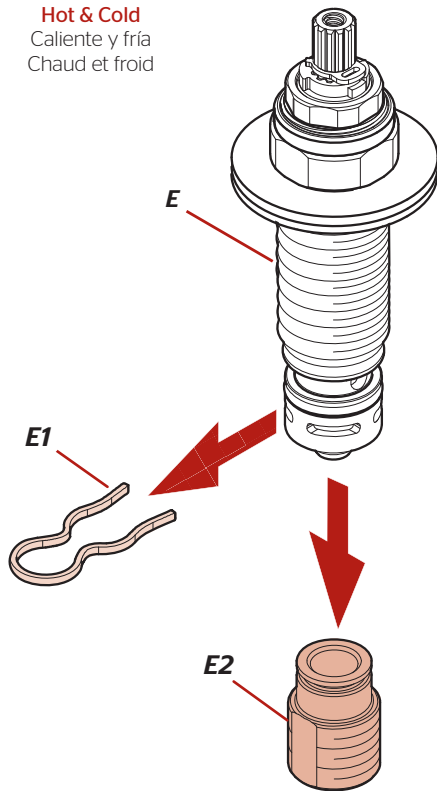

2B

Temporarily place handles onto stems to align the levers. **DO NOT** use handles to tighten valve.

Coloque temporalmente las manijas en los vástagos para alinear las palancas. **NO** utilice las manijas para apretar la válvula.

Placer temporairement les poignées sur les tiges pour aligner les leviers. **NE PAS** utiliser les poignées pour serrer la valve.

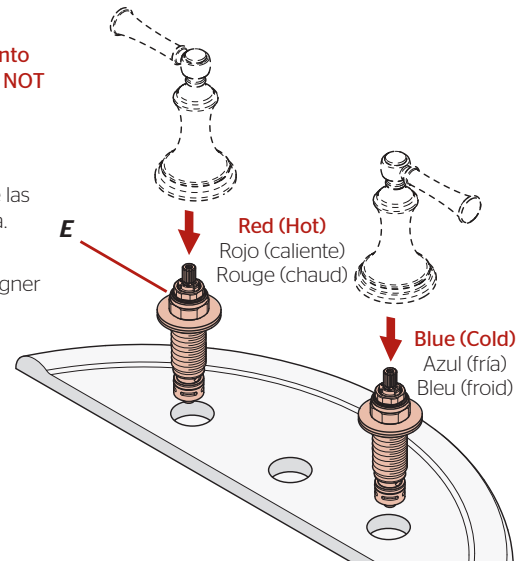

2C

HOT
CALIENTE
CHAUD

COLD
FRÍA
FROID

Open
Abierta
Ouvverte

Open
Abierta
Ouvverte

Before final tightening, be sure that both handles rotate as shown.
Antes del apriete final, asegúrese de que ambas manijas giran como se muestra.
Avant le serrage final, être sûr que les deux poignées tournent comme indiqué.

2D

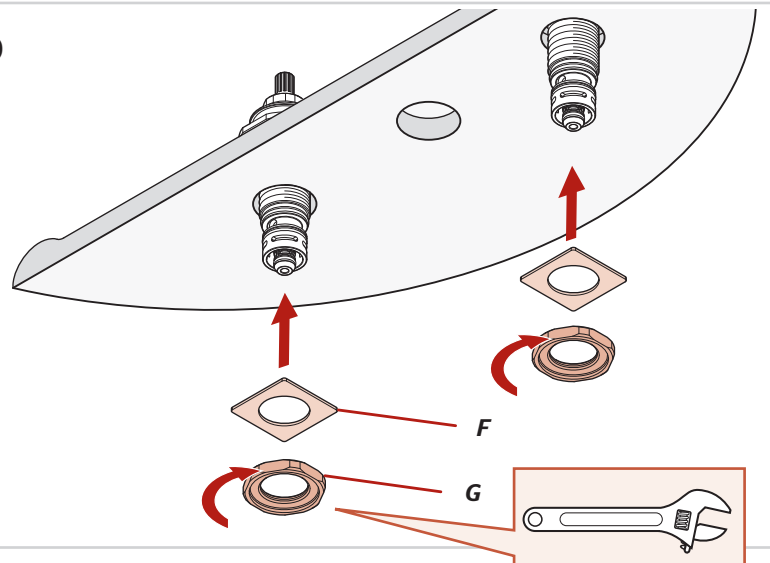

Save for step 5.

Guarde para el paso 5.

Mettez de l'étape 5.

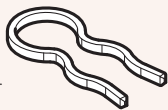

E1 (x2)



E2 (x2)

3

Install Handles & Spout

Instale las manijas y el surtidor

Installez les poignées et le bec

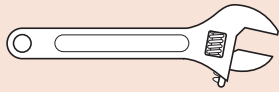

Adjustable Wrench
Llave ajustable
Clé réglable

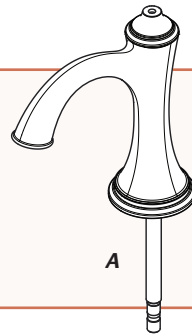

H

D

3A

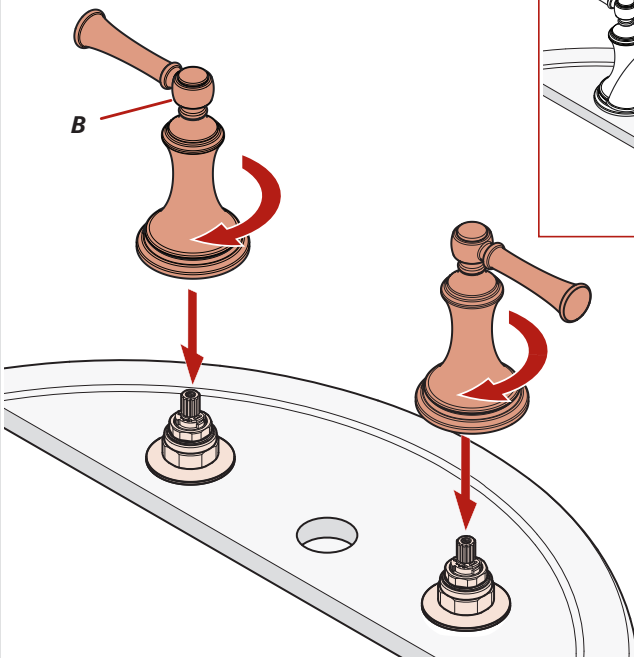

3B

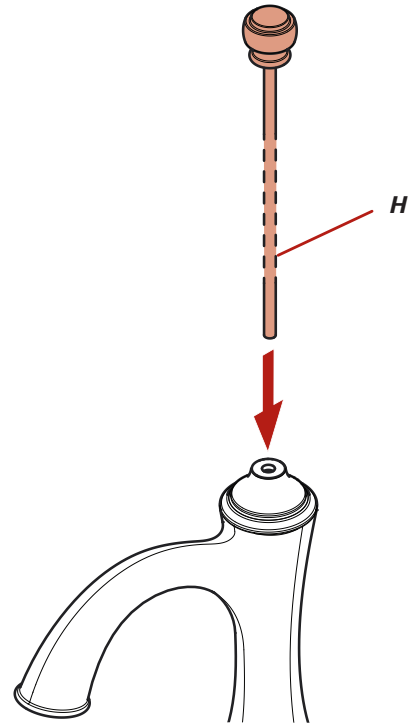

3C

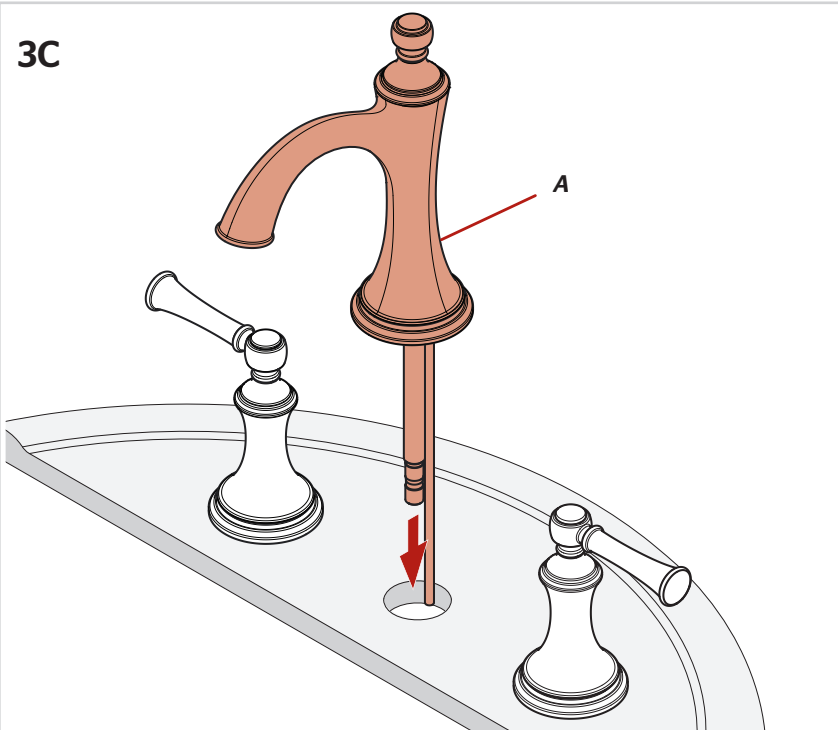

3D

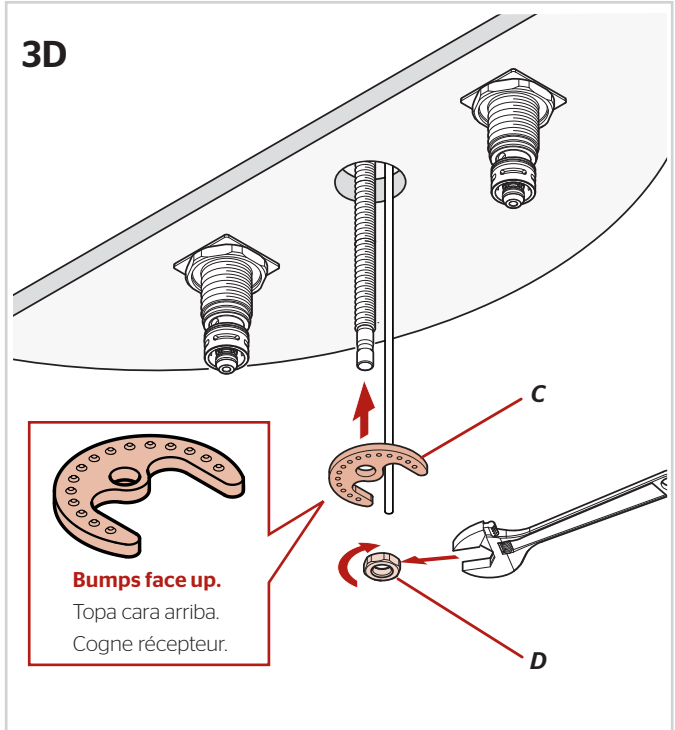

Bumps face up.

Topa cara arriba.

Cogne récepteur.

4

Install Hose

Instale la manguera

Posez le tuyau

No Tools Required for This Step
 No se necesitan herramientas para este paso
 Aucun outil n'est nécessaire pour cette étape

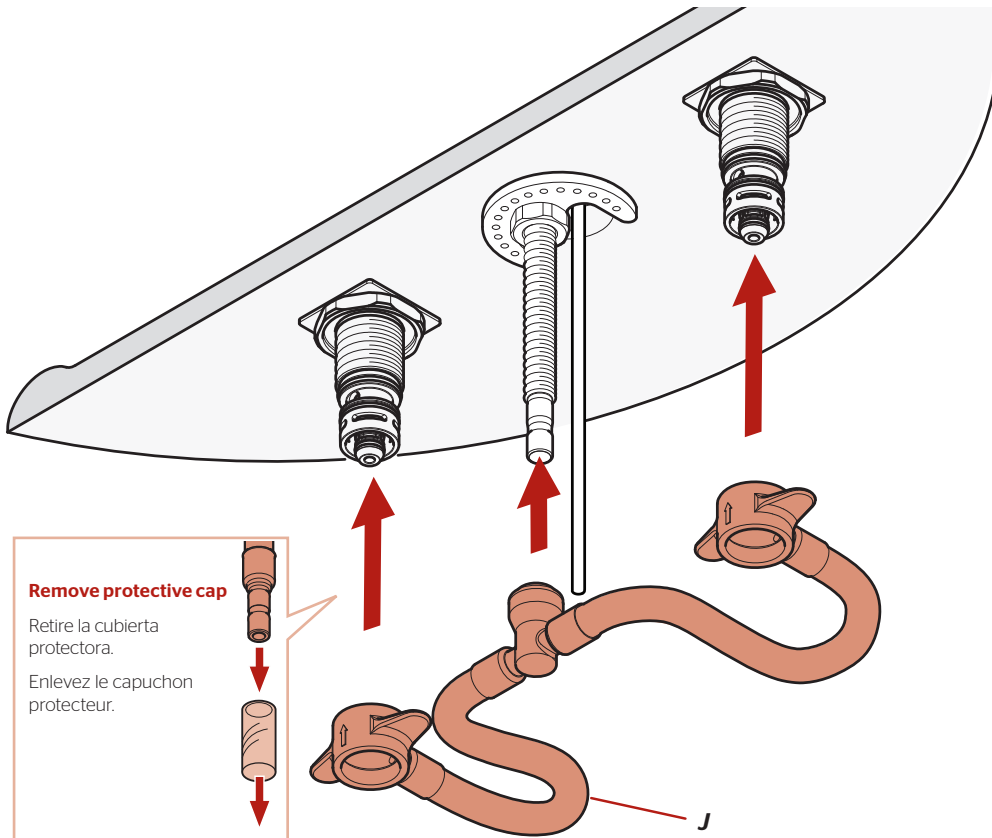
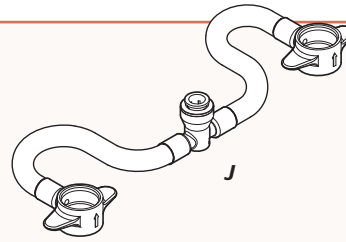

Remove protective cap

Retire la cubierta protectora.
 Enlevez le capuchon protecteur.

IMPORTANT: DO NOT damage O-Rings.

IMPORTANT: NO dañe las juntas tóricas.

IMPORTANT: NE PAS endommager les joints toriques.

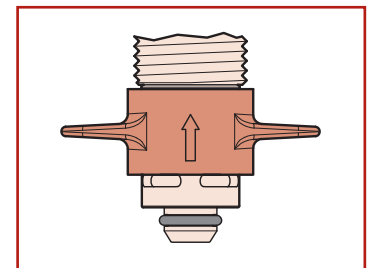
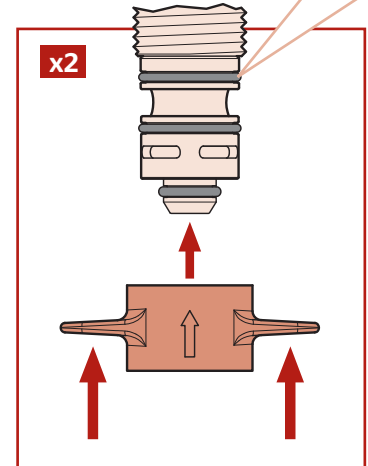

Check to see if the connection is secure by pulling down the Center Connector. If the Inner Collet separates slightly but does not pull off the Receiving Tube, connection is secure.

Revise si la conexión es segura halando hacia abajo el Quick Connector™. Si la anilla interna se separa ligeramente pero no se desprende del tubo receptor, la conexión está segura.

Vérifiez que le raccord est bien serré en tirant sur le Quick Connector™. Si le collet interne se sépare légèrement mais ne se détache pas du tube de réception, le raccord est bien serré.

Center Connector
 Centre el conector
 Raccord centre

Inner Colet
 Anilla interna
 Collette interne

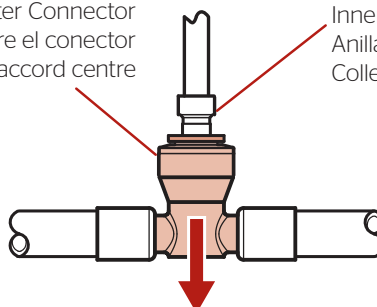

5 Connect Water Supply Lines

Conecte las tuberías de suministro de agua

Raccorder les conduites d'alimentation en eau

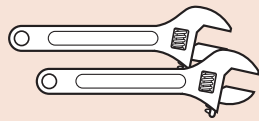

Adjustable Wrenches
Llaves ajustables
Clés à mollette

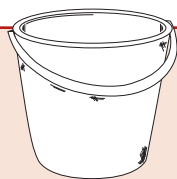

Bucket
Balde
Seau



E1 (x2)



E2 (x2)

From Step 2.

Desde el paso 2.

De l'étape 2.



Water Supply Lines not included. Please consult manufacturer and/or its instructions for the correct method of installation of supply lines & fittings.

IMPORTANT: Incorrect application of supply lines and fittings may result in the failure or leak of the supply lines and fitting.

Las tuberías de suministro de agua no están incluidas. Consulte por favor el fabricante y/o sus instrucciones para el método correcto de instalación de líneas de suministro y de guarniciones.

IMPORTANT: El uso incorrecto de líneas de suministro y de guarniciones puede dar lugar a la falta o al escape de las líneas de suministro y de la guarnición.

Les tuyaux d'arrivée d'eau ne sont pas fournis. Veuillez consulter le fabricant et/ou ses instructions pour la méthode correcte d'installation des conduites d'alimentation en eau et des accessoires.

IMPORTANT: Mauvaise application des lignes d'alimentation et accessoires peut entraîner la défaillance ou la fuite.

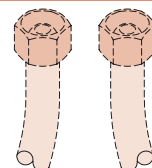

HOT
CALIENTE
CHAUD

COLD
FRÍA
FROID

5A

Point Lines in Bucket

Guiar las Líneas hacia el Balde
Guide les lignes en le Balde

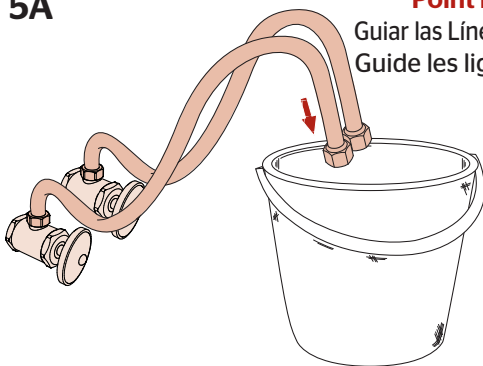

5E

x2

Hot & Cold
Caliente y fría
Chaud et froid



Water supply line
línea de suministro del agua
ligne d'approvisionnement en eau

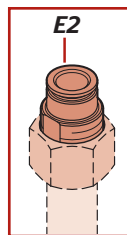

5G

x2

Hot & Cold
Caliente y fría
Chaud et froid

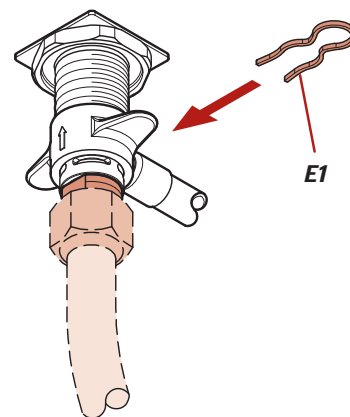

5B

Turn On Water

Active el suministro de agua
Ouvrez l'eau

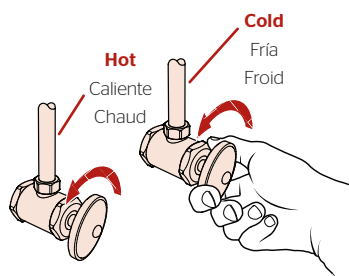

5C

Flush Lines

Enjuagar las Líneas
Rincer les Lignes

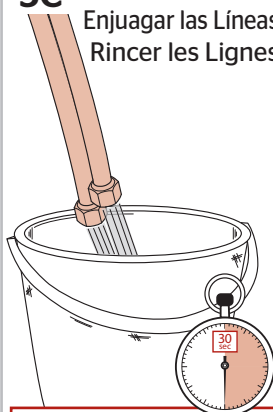

Allow water to run for at least 30 seconds.

Deje correr el agua durante al menos 30 segundos.

Permettez à l'eau couler au moins 30 secondes.

5D

Turn Off Water Supply

Cierre el suministro de agua
Couper l'alimentation en eau

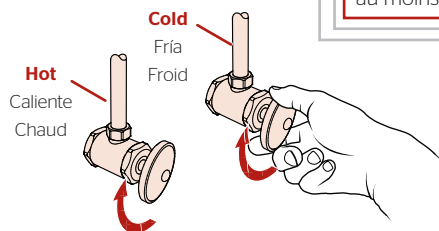

5F

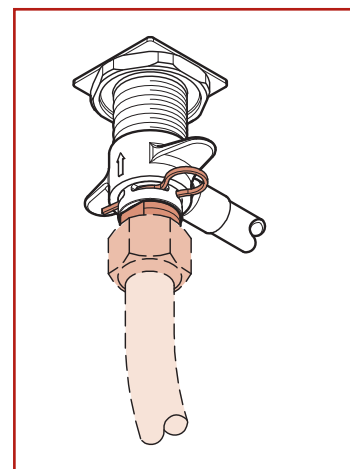
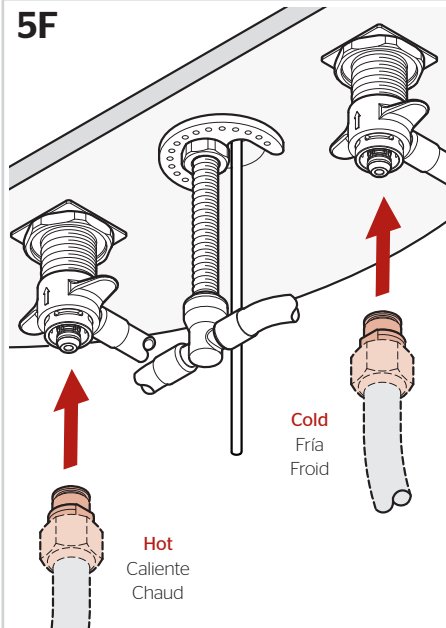

6

Prepare & Install Pop-Up

Prepare e instale el tapón retráctil

Préparez & installez le bouchon à clapet

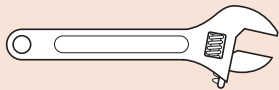

Adjustable Wrench
Llave ajustable
Clé réglable

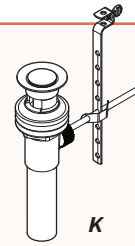

K

6A

Disassemble Pop-up Assembly

Desensamble el ensamble del tapón retráctil

Démontez l'ensemble bouchon à clapet

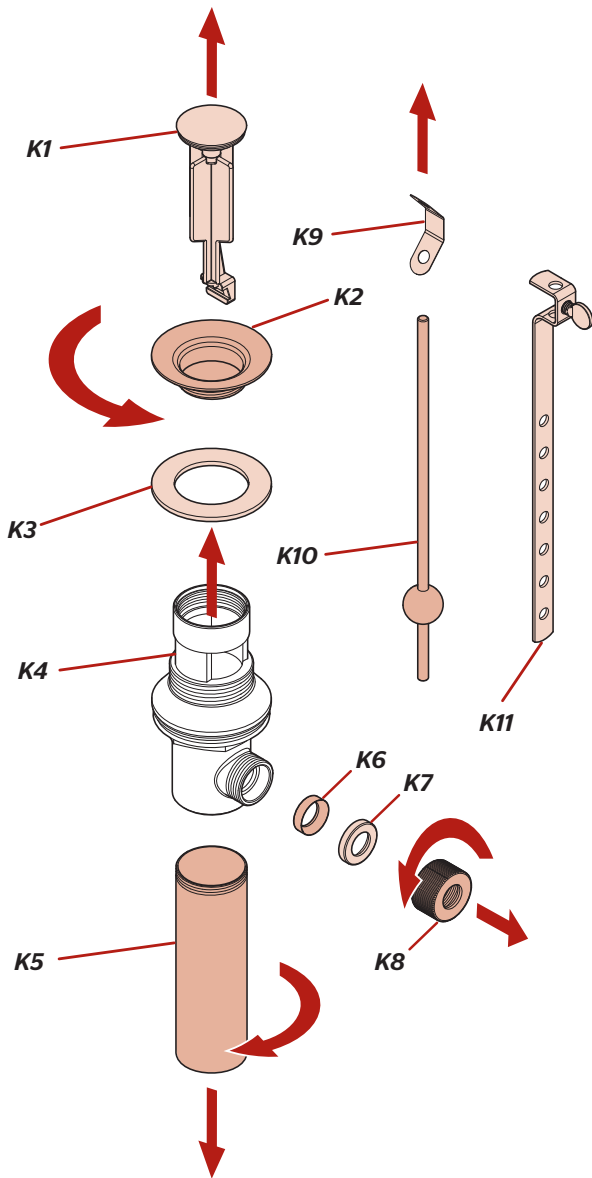

6B

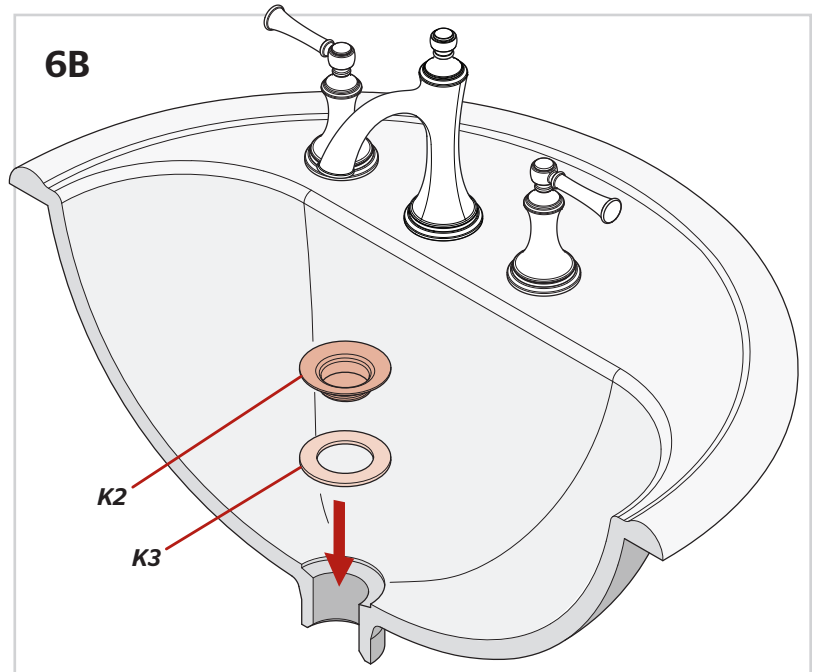

6C

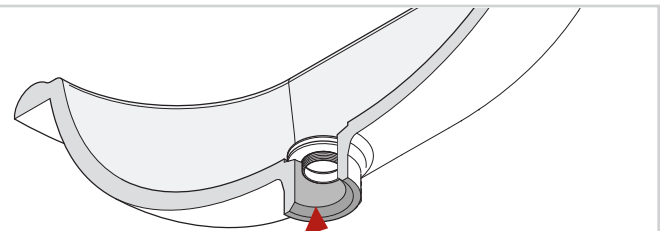

Thread Drain Body (K4) to bottom of Flange (K2) and adjust so that Ball Rod opening faces rear.

Enrosque la estructura de desagüe (K4) a la parte inferior de la pestaña (K2) y ajuste de modo que la abertura de la varilla con glóbulo esté orientada hacia la parte posterior.

Vissez le corps du renvoi (K4) au bas de la bride (K2) et réglez de façon à ce que l'ouverture de la tige soit tournée vers l'arrière.



Ball Rod Opening
Abertura de la varilla con glóbulo
Ouverture de la tige

K5

Connect to Drain
Conexión al desagüe
Branchez au renvoi

7 Prepare & Connect Lift Rod

Prepare y conecte la varilla de elevación

Préparez & connectez la tige levier

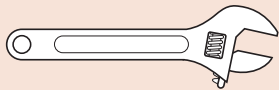

Adjustable Wrench
Llave ajustable
Clé réglable

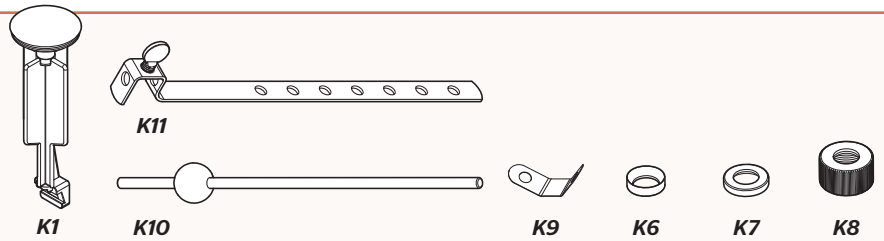

7A

Option 1
Opción 1
Option 1

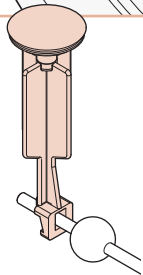

Option 2
Opción 2
Option 2

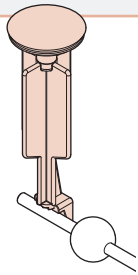

K1 can be installed in two ways: Fixed Position (Option 1) or a Removable Position (Option 2)

K1 puede instalarse de dos formas: posición fija (Opción 1) o posición removable (Opción 2).

On peut installer K1 de deux façons : Position fixe (Option 1) ou position amovible (Option 2).

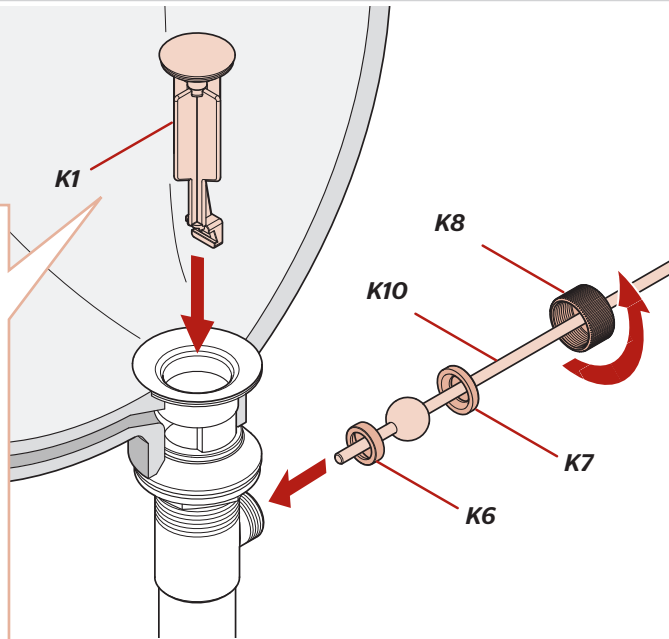

7B Assemble Lift Rod Connection

Ensamble de la conexión de varilla de elevación

Assemblez la connexion de la tige levier

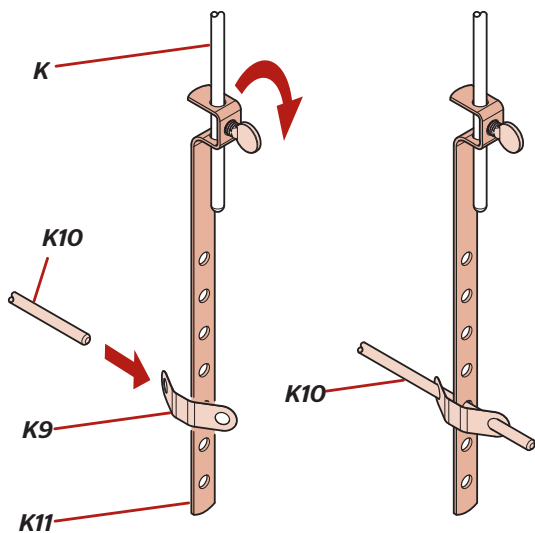

7C Pop-Up Completion

Terminer le bouchon à clapet

Finalización de la instalación del tapón retráctil

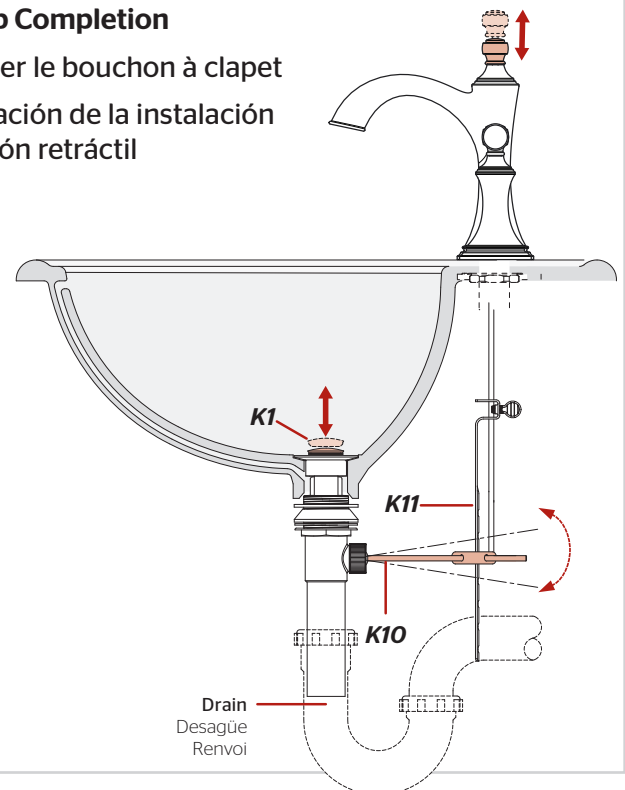

8 Turn On Water & Confirm Proper Installation

Active el suministro de agua y confirme que la instalación está adecuadamente efectuada

Ouvrez l'eau et confirmez que l'installation est adéquate

8A

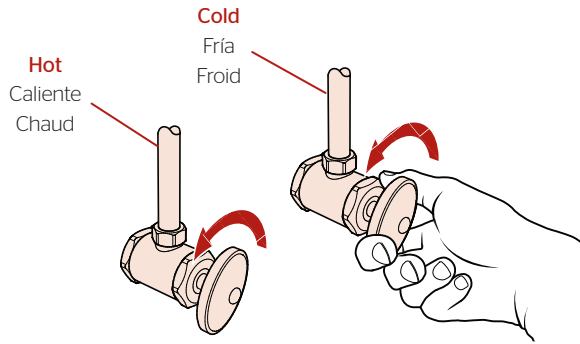

Faucet Functions • Funciones del grifo • Fonctions du robinet

Hot
Caliente
Chaud

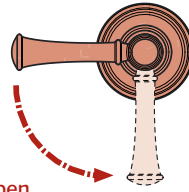

Open
Abierta
Ouvverte

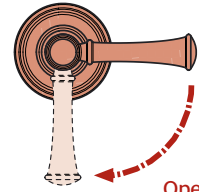

Cold
Fría
Froid

Open
Abierta
Ouvverte



Check for leaks above and below the sink.

Revise si hay fugas encima y debajo del fregadero

Assurez-vous qu'il n'y a pas de fuite au dessus ou au dessous du lavabo

9 Flush the Faucet

Enjuague el grifo

Vidanger l'robinet

9A Remove Aerator

Retire el aereador
Retirez l'aérateur

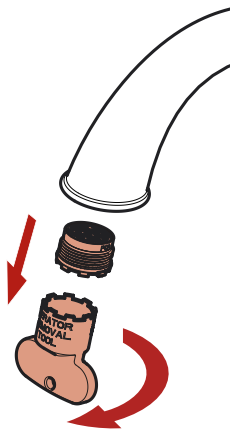

9B

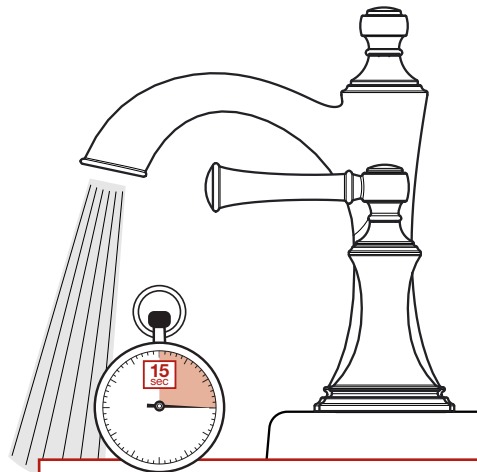

Allow full hot & full cold water to run for at least 15 seconds each.

Deje correr el agua caliente y fría durante al menos 15 segundos cada una.

Permettez à l'eau chaude et l'eau froide de couler au moins 15 secondes chacun.

9C Reinstall Aerator

Reinstale el aereador
Réinstallez l'aérateur

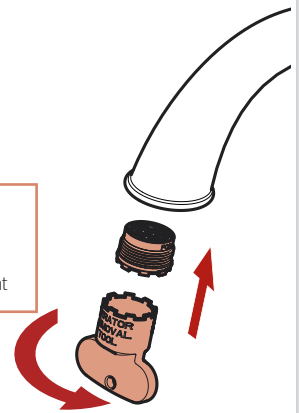

Hand Tighten

Apriete con la mano

Serrez manuellement

For Additional Installation Help:

Para la instalación adicionales de ayuda:

Pour aider à l'installation supplémentaires:

Pfister

1-800-PFAUCET (732-8238)
pfisterfaucets.com