



## Underscore® Rectangle

72" x 42" drop-in bath

K-1137

### Features

- Spacious design accommodates up to two bathers.
- Integral lumbar support.
- Slotted overflow allows for deep soaking.
- Center drain.

### Material

- Acrylic.

### Installation

- Undermount.
- Drop-in or undermount.

### Required Products/Accessories

K-7271 Brass Slotted Overflow Bath Drain

or

K-7272 PVC Slotted Overflow Bath Drain

### Recommended Products/Accessories

K-592 Under-Mount Installation Kit

K-24916 Wireless Music Kit

K-1601 Bath/whirlpool footstop, removable

K-23726 Drain treatment

K-23732 Tub & shower cleaner



### Codes/Standards

CSA B45.5/IAPMO Z124

ASTM E162









ASTM E662

### KOHLER® Plastic Baths and Shower Bases Lifetime Limited Warranty

See website for detailed warranty information.

### Available Colors/Finishes

*Color tiles intended for reference only.*

Color	Code	Description
	0	White
	96	Biscuit
	NY	Dune
	95	Ice™ Grey
	G9	Sandbar
	K4	Cashmere
	58	Thunder™ Grey
	7	Black Black™

1-800-4KOHLER (1-800-456-4537)

Kohler Co. reserves the right to make revisions without notice to product specifications.

For the most current Specification Sheet, go to [www.kohler.com](http://www.kohler.com).

THE BOLD LOOK  
OF **KOHLER**®

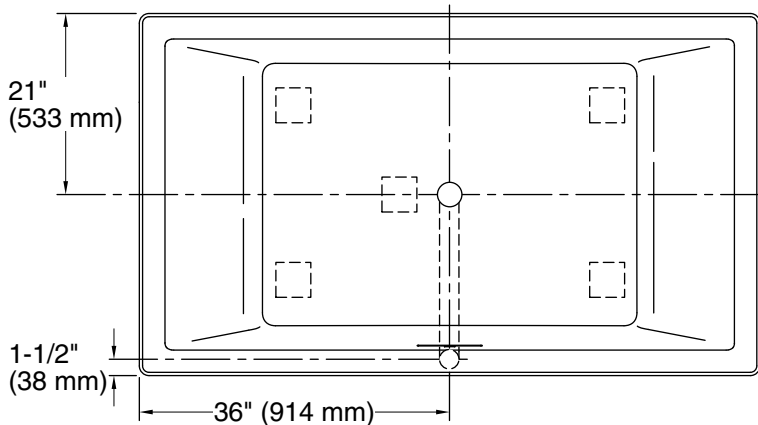

No change in measurements if connected with drain illustrated. (K-7272)

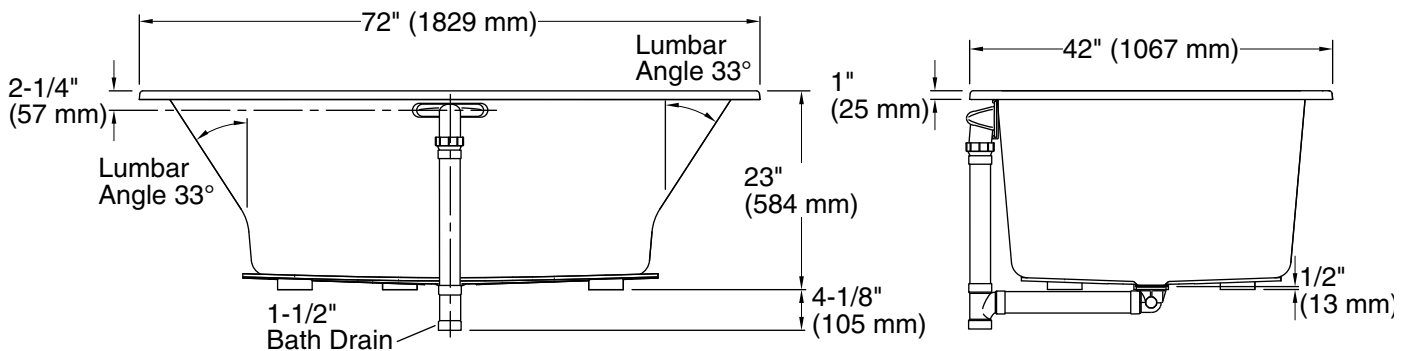

### Technical Information

All product dimensions are nominal.

Installation:	Drop-in
Drain location:	Center
Basin area, bottom:	45-3/4" x 32" (1162 mm x 813 mm)
Basin area, top:	66" x 36" (1676 mm x 914 mm)
Weight:	85 lbs (38.6 kg)
Minimum floor load:	60 lbs/ft <sup>2</sup> (292.9 kg/m <sup>2</sup> )
Water depth:	19" (483 mm)
Water capacity:	139 gal (526.2 L)
Cutout:	Drop-in, 70-1/2" x 40-1/2" (1791 mm x 1029 mm)
Minimum flat for door:	2-9/16" (66 mm)

### Notes

Measure your actual product for rough-in details.

Install this product according to the installation instructions.

The hot water supply should be 70% of the capacity of the bath or greater. Installations will vary.

Kit is required for under-mount installations (sold separately).