



# Underscore® Rectangle

60" x 30" drop-in bath

K-1121

### Features

- Integral lumbar support.
- Slotted overflow allows for deep soaking.

### Material

- Acrylic.

### Installation

- Requires K-7271 or K-7272 Clearflo slotted overflow bath drain (sold separately).
- Drop-in or undermount.

### Required Products/Accessories

K-7271 Brass Slotted Overflow Bath Drain

or

K-7272 PVC Slotted Overflow Bath Drain

### Recommended Products/Accessories

- K-531 Under-Mount Installation Kit
- K-1491 Bath/Whirlpool Pillow
- K-1601 Bath/whirlpool footstop, removable
- K-24916 Wireless Music Kit
- K-702200-G73 Frameless Sliding Bath Door
- K-702200-L Frameless Sliding Bath Door
- K-706000-D3 Frameless Sliding Bath Door
- K-706000-L Frameless Sliding Bath Door
- K-706003-L Frameless Sliding Bath Door
- K-706004-D3 Frameless Sliding Bath Door
- K-706004-L Frameless Sliding Bath Door
- K-706007-L Frameless Sliding Bath Door
- K-1177 Vinyl Tiling-in Bead
- K-23726 Drain treatment
- K-23732 Tub & shower cleaner



ADA

### Codes/Standards

CSA B45.5/IAPMO Z124

ASTM E162

ASTM E662

ADA









ICC/ANSI A117.1

### KOHLER® Plastic Baths and Receptors Lifetime Limited Warranty

See website for detailed warranty information.

### Available Colors/Finishes

*Color tiles intended for reference only.*

Color	Code	Description
	0	White
	96	Biscuit
	47	Almond
	NY	Dune
	95	Ice™ Grey
	G9	Sandbar
	K4	Cashmere
	58	Thunder™ Grey
	7	Black Black™

1-800-4KOHLER (1-800-456-4537)

Kohler Co. reserves the right to make revisions without notice to product specifications.

For the most current Specification Sheet, go to [www.kohler.com](http://www.kohler.com).

THE BOLD LOOK  
OF **KOHLER**®

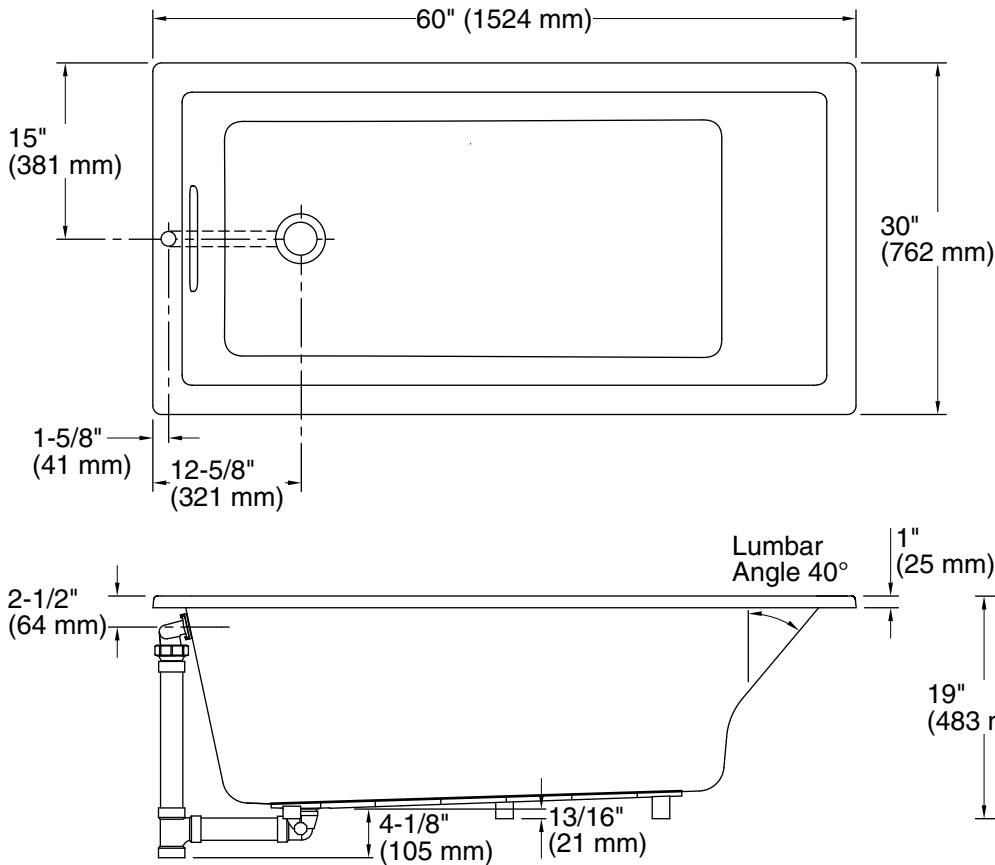

No change in measurement if connected with drain illustrated. (K-7272)

### Technical Information

All product dimensions are nominal.

Installation:	Drop-in, Under-mount
Drain location:	End
Basin area, bottom:	42-3/8" x 20" (1076 mm x 508 mm)
Basin area, top:	54-3/8" x 24-5/16" (1381 mm x 618 mm)
Weight:	71 lbs (32.2 kg)
Minimum floor load:	50 lbs/ft <sup>2</sup> (244.1 kg/m <sup>2</sup> )
Water depth:	15-1/16" (383 mm)
Water capacity:	59.8 gal (226.4 L)
Cutout:	Drop-in, 59-1/2" x 28-1/2" (1511 mm x 724 mm)
Minimum flat for door:	1-15/16" (50 mm)

### Notes

Measure your actual product for rough-in details.

Install this product according to the installation instructions.

The hot water supply should be 70% of the capacity of the bath or greater. Installations will vary.

Kit is required for under-mount installations (sold separately).

ADA compliant when installed to the specific requirements of these regulations.